STATUTORY INSTRUMENTS

1995 No. 2700

CIVIL AVIATION

The Air Navigation (Hong Kong) Order 1995

<i>Made</i>	- - - -	<i>18th October 1995</i>
<i>Laid before Parliament</i>		<i>30th October 1995</i>
		<i>in accordance with</i>
<i>Coming into force</i>	- -	<i>Article 1(2) and (3)</i>

At the Court at Buckingham Palace, the 18th day of October 1995

Present,

The Queen's Most Excellent Majesty in Council

Her Majesty, in exercise of the powers conferred on Her by sections 8, 41, 57, 58, 59 and 61 of the Civil Aviation Act 1949(1), as extended to certain territories by the Civil Aviation Act 1949 (Overseas Territories) Order 1969(2), as amended by the Civil Aviation Act 1971 (Overseas Territories) Order 1976(3), and all other powers enabling Her in that behalf, is pleased, by and with the advice of Her Privy Council, to order, and it is hereby ordered, as follows:

CITATION, COMMENCEMENT AND REVOCATION

Citation and Commencement

- 1.—(1) This Order may be cited as the Air Navigation (Hong Kong) Order 1995.
- (2) Subject to paragraph (3), this Order shall come into force on 1st December 1995.
- (3) Article 74 of this Order shall come into force on 1st June 1996 after.

Revocation and Transitional Provisions

2.—(1) Subject to paragraph (2), the Air Navigation (Overseas Territories) Order 1977(4), the Air Navigation (Overseas Territories) (Amendment) Order 1977(5) and the Air Navigation (Overseas Territories) (Second Amendment) Order 1978(6) are hereby revoked.

(1) 1949 c. 67.
(2) S.I. 1969/592.
(3) S.I. 1976/1912.
(4) S.I. 1977/422.
(5) S.I. 1977/820.
(6) S.I. 1978/1520.

- (a) (2) (a) Article 69 of the Air Navigation (Overseas Territories) Order 1977 is revoked as from 1st June 1996.
- (b) Article 70 of the Air Navigation (Overseas Territories) Order 1977 is revoked as from 1st December 1996.
- (c) The Orders mentioned in paragraph (1) shall remain in operation until 1st June 1996 for the purposes of applying the provision mentioned in sub-paragraph (a), and until 1st December 1996 for the purposes of applying the provision mentioned in sub-paragraph (b).
- (d) (i) Until 1st December 1996, the Governor may, either generally, or for a particular period, or in any particular case or class of cases, apply, as seems to him to be appropriate, either the provisions of Articles 8(7), 9 and 11 of the Air Navigation (Overseas Territories) Order 1977(7) or the provisions of Articles 8(7), 9 and 11 of this Order.
- (ii) In any case where in accordance with sub-paragraph (d)(i) the Governor applies the provisions of Articles 8(7), 9 and 11 of the Air Navigation (Overseas Territories) Order 1977, then—
- (aa) the Orders mentioned in paragraph (1) shall remain in operation until 1st December 1996 for the purposes of applying Articles 8(7), 9 and 11 of the Air Navigation (Overseas Territories) Order 1977; and
- (bb) any reference in this Order to a “certificate of maintenance review” or to a “certificate of release to service” shall be construed as a reference respectively, to a “certificate of maintenance” or to a “certificate of compliance”.
- (3) This Article shall apply to the Orders mentioned therein and to the provisions of any Order mentioned therein only insofar as the Order or those provisions form part of the law of Hong Kong.
- (4) Notwithstanding the revocation of the Orders mentioned in paragraph (1) of this Article, any instrument (that is to say any regulation, direction, instrument, rule or other requirement, any notice and any certificate, licence, approval, permission, exemption, log book, record or other document) issued, made, served or granted under those Orders, or under any enactment revoked by any of those Orders, if in force at the commencement of this Order, shall (except to the extent that such instrument is inconsistent with the provisions of this Order, and without prejudice to Article 62 of this Order or to any power to amend any such instrument) continue in force until superseded, revoked or otherwise terminated and, so far as it could have been issued, made, served or granted under this Order, shall have effect as if issued, made, served or granted under this Order and this Order shall apply to or in relation to such instrument accordingly:
- Provided that any such instrument which is expressed to remain in force for a definite period shall not remain in force after the expiration of that period unless it shall be renewed in accordance with the provisions of this Order or in accordance with any prescribed provisions.

PART I

REGISTRATION AND MARKING OF AIRCRAFT

Aircraft to be registered

- 3.—**(1) An aircraft shall not fly in or over Hong Kong unless it is registered in:
- (a) some part of the Commonwealth; or

(7) Article 11 of the Air Navigation (Overseas Territories) Order 1977 was amended by Article 2(2) of the Air Navigation (Overseas Territories) (Second Amendment) Order 1978.

- (b) a Contracting State; or
- (c) some other country in relation to which there is in force an agreement between Her Majesty's Government in the United Kingdom and the Government of that country which makes provision for the flight over Hong Kong of aircraft registered in that country;

Provided that:

- (i) any aircraft may fly unregistered on any flight which:
 - (a) begins and ends in Hong Kong without passing over any other country, and
 - (b) is in accordance with the "B Conditions" set forth in Schedule 2 to this Order.
- (ii) this paragraph shall not apply to any kite or captive balloon.

(2) If an aircraft flies over Hong Kong in contravention of paragraph (1) of this Article in such manner or circumstances that if the aircraft had been registered in Hong Kong an offence against this Order or any regulations made thereunder would have been committed, the like offence shall be deemed to have been committed in respect of that aircraft.

Registration of aircraft in Hong Kong

4.—(1) The Governor shall be the authority for the registration of aircraft in Hong Kong. He may cause a register to be kept and may record therein the particulars specified in paragraph (7) of this Article in either a legible or a non-legible form, so long as the recording is capable of being reproduced in a legible form.

(2) Subject to the provisions of this Article, an aircraft shall not be registered or continue to be registered in Hong Kong if it appears to the Governor that:

- (a) the aircraft is registered outside Hong Kong and that such registration does not cease by operation of law upon the aircraft being registered in Hong Kong; or
- (b) an unqualified person holds any legal or beneficial interest by way of ownership in the aircraft or any share therein; or
- (c) the aircraft could more suitably be registered in some other country or territory; or
- (d) it would be inexpedient in the public interest for the aircraft to be or to continue to be registered in Hong Kong.

(3) The following persons and no others shall be qualified to hold a legal or beneficial interest by way of ownership in an aircraft registered in Hong Kong or a share therein:

- (a) the Crown in right of Her Majesty's Government in the United Kingdom or in right of the Government of Hong Kong;
- (b) British Nationals;
- (c) British protected persons;
- (d) bodies incorporated in or under the law of Hong Kong or in the United Kingdom and having their principal place of business in Hong Kong or the United Kingdom.

(4) If an unqualified person residing or having a place of business in Hong Kong holds a legal or beneficial interest by way of ownership in an aircraft, or a share therein, the Governor, upon being satisfied that the aircraft may otherwise be properly so registered, may register the aircraft in Hong Kong. The person aforesaid shall not cause or permit the aircraft, while it is registered in pursuance of this paragraph, to be used for the purpose of public transport or aerial work.

(5) If an aircraft is chartered by demise to a person qualified as aforesaid the Governor may, whether or not an unqualified person is entitled as owner to a legal or beneficial interest therein, register the aircraft in Hong Kong in the name of the charterer upon being satisfied that the aircraft may otherwise be properly so registered, and subject to the provisions of this Article the aircraft may remain so registered during the continuation of the charter.

(6) Application for the registration of an aircraft in Hong Kong shall be made in writing to the Governor, and shall include or be accompanied by such particulars and evidence relating to the aircraft and the ownership and chartering thereof as he may require to enable him to determine whether the aircraft may properly be registered in Hong Kong and to issue the certificate referred to in paragraph (8) of this Article. In particular, the application shall include the proper description of the aircraft according to column 4 of the “General Classification of Aircraft” set forth in Part A of Schedule 1 to this Order.

(7) Upon receiving an application for the registration of an aircraft in Hong Kong and being satisfied that the aircraft may properly be so registered, the Governor shall register the aircraft, wherever it may be, and shall include in the register the following particulars:

- (a) the number of the certificate;
- (b) the nationality mark of the aircraft, and the registration mark assigned to it by the Governor;
- (c) the name of the constructor of the aircraft and its designation;
- (d) the serial number of the aircraft; and
- (e)
 - (i) the name and address of every person who is entitled as owner to a legal interest in the aircraft or a share therein, or, in the case of an aircraft which is the subject of a charter by demise, the name and address of the charterer by demise; and
 - (ii) in the case of an aircraft registered in pursuance of paragraph (4) or (5) of this Article, an indication that it is so registered.

(8) The Governor shall furnish to the person in whose name the aircraft is registered (hereinafter in this Article referred to as “the registered owner”) a certificate of registration, which shall include the foregoing particulars and the date on which the certificate was issued:

Provided that the Governor shall not be required to furnish a certificate of registration if the registered owner is the holder of an aircraft dealer’s certificate granted under this Order who has made to the Governor and has not withdrawn a statement of his intention that the aircraft is to fly only in accordance with the conditions set forth in Part C of Schedule 1 to this Order, and in that case the aircraft shall fly only in accordance with those conditions.

(9) The Governor may grant to any person qualified as aforesaid an aircraft dealer’s certificate if he is satisfied that he has a place of business in Hong Kong for buying and selling aircraft.

(10) Subject to paragraphs (4) and (5) of this Article, if at any time after an aircraft has been registered in Hong Kong an unqualified person becomes entitled to a legal or beneficial interest by way of ownership in the aircraft or a share therein, the registration of the aircraft shall thereupon become void and the certificate of registration shall forthwith be returned by the registered owner to the Governor.

(11) Any person who is the registered owner of an aircraft registered in Hong Kong shall forthwith inform the Governor in writing of:

- (a) any change in the particulars which were furnished to the Governor upon application being made for the registration of the aircraft;
- (b) the destruction of the aircraft, or its permanent withdrawal from use;
- (c) in the case of an aircraft registered in pursuance of paragraph (5) of this Article, the termination of the demise charter.

(12) Any person who becomes the owner of an aircraft registered in Hong Kong shall within 28 days inform the Governor in writing to that effect.

(13) The Governor may, whenever it appears to him necessary or appropriate to do so for giving effect to this Part of this Order or for bringing up to date or otherwise correcting the particulars entered on the register, amend the register or, if he thinks fit, may cancel the registration of the

aircraft, and shall cancel that registration within two months of being satisfied that there has been a change in the ownership of the aircraft.

(14) Deleted.

(15) In this Article references to an interest in an aircraft do not include references to an interest in an aircraft to which a person is entitled only by virtue of his membership of a flying club and the reference in paragraph (11) of this Article to the registered owner of an aircraft includes in the case of a deceased person, his legal personal representative, and in the case of a body corporate which has been dissolved, its successor.

(16) Nothing in this Article shall require the Governor to cancel the registration of an aircraft if in his opinion it would be inexpedient in the public interest to do so.

(17) The Governor shall transmit to the Civil Aviation Authority particulars of all registrations and of changes in or cancellations of registrations, entered in the register.

Nationality and registration marks

5.—(1) An aircraft (other than an aircraft permitted by or under this Order to fly without being registered) shall not fly unless it bears painted thereon or affixed thereto, in the manner required by the law of the country in which it is registered, the nationality and registration marks required by that law.

(2) The marks to be borne by aircraft registered in Hong Kong shall comply with Part B of Schedule 1 to this Order.

(3) An aircraft shall not bear any marks which purport to indicate:

- (a) that the aircraft is registered in a country in which it is not in fact registered, provided that marks approved by the Governor for the purposes of flights in accordance with the “B Conditions” contained in Schedule 2 to this Order shall be deemed not to purport to indicate that the aircraft is so registered; or
- (b) that the aircraft is a State aircraft of a particular country if it is not in fact such an aircraft, unless the appropriate authority of that country has sanctioned the bearing of such marks.

PART II

AIR OPERATORS' CERTIFICATES

Issue of air operators' certificates

6.—(1) An aircraft registered in Hong Kong shall not fly on any flight for the purpose of public transport, otherwise than under and in accordance with the terms of an air operator's certificate granted to the operator of the aircraft under paragraph (2) of this Article, certifying that the holder of the certificate is competent to secure that aircraft operated by him on such flights as that in question are operated safely.

(2) The Governor may grant to any person applying therefor an air operator's certificate if he is satisfied that that person is competent, having regard in particular to his previous conduct and experience, his equipment, organisation, staffing, maintenance and other arrangements, to secure the safe operation of aircraft of the types specified in the certificate on flights of the description and for the purposes so specified. The certificate may be granted subject to such conditions as the Governor thinks fit and shall, subject to the provisions of Article 62 of this Order, remain in force for the period specified in the certificate.

PART III

AIRWORTHINESS AND EQUIPMENT OF AIRCRAFT

Certificate of airworthiness to be in force

7.—(1) An aircraft shall not fly unless there is in force in respect thereof a certificate of airworthiness duly issued or rendered valid under the law of the country in which the aircraft is registered, and any conditions subject to which the certificate was issued or rendered valid are complied with:

Provided that the foregoing prohibition shall not apply to flights, beginning and ending in Hong Kong without passing over any other country, of:

- (a) a glider, if it is not being used for the public transport of passengers or aerial work other than aerial work which consists of the giving of instruction in flying or the conducting of flying tests in a glider owned or operated by a flying club of which the person giving the instruction or conducting the test and the person receiving the instruction or undergoing the test are both members;
- (b) a balloon, if it is not being used for the public transport of passengers;
- (c) a kite;
- (d) an aircraft flying in accordance with the “A Conditions” or the “B Conditions” set forth in Schedule 2 to this Order; and
- (e) an aircraft flying in accordance with the conditions of a permit to fly issued by the Governor in respect of that aircraft.

(2) In the case of an aircraft registered in Hong Kong the certificate of airworthiness referred to in paragraph (1) of this Article shall be a certificate issued or rendered valid in accordance with the provisions of Article 8 of this Order.

Issue, renewal, etc., of certificates of airworthiness

8.—(1) The Governor shall issue in respect of any aircraft a certificate of airworthiness if he is satisfied that the aircraft is fit to fly having regard to:

- (a) the design, construction, workmanship and materials of the aircraft (including in particular any engines fitted therein), and of any equipment carried in the aircraft which he considers necessary for the airworthiness of the aircraft; and
- (b) the results of flying trials, and such other tests of the aircraft as he may require:

Provided that, if the Governor has issued a certificate of airworthiness in respect of an aircraft which, in his opinion, is a prototype aircraft or a modification of a prototype aircraft, he may dispense with flying trials in the case of any other aircraft if he is satisfied that it conforms to such prototype or modification.

(2) Every certificate of airworthiness shall specify such categories as are, in the opinion of the Governor, appropriate to the aircraft in accordance with Schedule 3 to this Order and the certificate shall be issued subject to the condition that the aircraft shall be flown only for the purposes indicated in the said Schedule in relation to those categories.

(3) The Governor may issue the certificate of airworthiness subject to such other conditions relating to the airworthiness of the aircraft as he thinks fit.

(4) The certificate of airworthiness may designate the performance group to which the aircraft belongs for the purposes of the requirements referred to in Article 29(1) of this Order.

(5) The Governor may, subject to such conditions as he thinks fit, issue a certificate of validation rendering valid for the purposes of this Order a certificate of airworthiness issued in respect of any aircraft under the law of any country other than Hong Kong.

(6) Subject to the provisions of this Article and of Article 62 of this Order, a certificate of airworthiness or validation issued under this Article shall remain in force for such period as may be specified therein, and may be renewed from time to time by the Governor for such further period as he thinks fit.

(7) A certificate of airworthiness or a certificate of validation issued in respect of an aircraft shall cease to be in force:

- (a) if the aircraft, or such of its equipment as is necessary for the airworthiness of the aircraft, is overhauled, repaired or modified, or if any part of the aircraft or of such equipment is removed or is replaced, otherwise than in a manner and with material of a type approved by the Governor either generally or in relation to a class of aircraft or to the particular aircraft;
- (b) until the completion of any inspection of the aircraft or of any such equipment as aforesaid, being an inspection made for the purpose of ascertaining whether the aircraft remains airworthy and:
 - (i) classified as mandatory by the Governor;
 - (ii) required by a maintenance schedule approved by the Governor in relation to that aircraft; or
- (c) until the completion to the satisfaction of the Governor of any modification of the aircraft or of any such equipment as aforesaid, being a modification required by the Governor for the purpose of ensuring that the aircraft remains airworthy.

(8) Nothing in this Order shall oblige the Governor to accept an application for the issue of a certificate of airworthiness or validation or for the variation or renewal of any such certificate when the application is not supported by such reports from such approved persons as the Governor may specify (either generally or in a particular case or class of cases).

Certificate of maintenance review

9.—(1) An aircraft registered in Hong Kong in respect of which a certificate of airworthiness in either the transport or in the aerial work category is in force shall not fly unless:

- (a) the aircraft (including in particular its engines), together with its equipment and radio station, is maintained in accordance with a maintenance schedule approved by the Governor in relation to that aircraft; and
- (b) there is in force a certificate (in this Order referred to as a “certificate of maintenance review”) issued in respect of the aircraft in accordance with the provisions of this Article and such certificate shall certify the date on which the maintenance review was carried out and the date thereafter when the next review is due.

(2) The approved maintenance schedule referred to in paragraph (1) of this Article shall specify the occasions on which a review must be carried out for the purposes of issuing a certificate of maintenance review.

(3) A certificate of maintenance review may be issued for the purposes of this Article only by:

- (a) the holder of an aircraft maintenance engineer’s licence:
 - (i) granted under this Order being a licence which entitles him to issue that certificate;
 - (ii) granted under the law of a country other than Hong Kong and rendered valid under this Order in accordance with the privileges endorsed on the licence; or

- (iii) granted under the law of any country specified in Regulation 13 in Schedule 15 to this Order in accordance with the privileges endorsed on the licence and subject to any conditions which may be prescribed;
- (b) a person whom the Governor has authorised to issue a certificate of maintenance review in a particular case, and in accordance with that authority; or
- (c) a person approved by the Governor as being competent to issue such certificates, and in accordance with that approval:

Provided that, in approving a maintenance schedule, the Governor may direct that certificates of maintenance review relating to that schedule, or to any part thereof specified in its direction, may be issued only by the holder of such a licence as is so specified.

(4) A person referred to in paragraph (3) of this Article shall not issue a certificate of maintenance review unless he has first verified that:

- (a) maintenance has been carried out on the aircraft in accordance with the maintenance schedule approved for that aircraft;
- (b) inspections and modifications required by the Governor as provided in Article 8 of this Order have been completed as certified in the relevant certificate of release to service issued in accordance with Article 11 of this order;
- (c) defects entered in the technical log of the aircraft in accordance with Article 10 of this Order have been rectified or the rectification thereof has been deferred in accordance with procedures approved by the Governor; and
- (d) certificates of release to service have been issued in accordance with Article 11 of this Order;

and for this purpose the operator of the aircraft shall make available to that person such information as is necessary.

(5) A certificate of maintenance review shall be issued in duplicate. One copy of the most recently issued certificate shall be carried in the aircraft when Article 57 of this Order so requires, and the other shall be kept by the operator elsewhere than in the aircraft.

(6) Subject to the provisions of Article 61 of this Order, each certificate of maintenance review shall be preserved by the operator of the aircraft for a period of two years after it has been issued.

(7) For the purpose of this Article a “person” may include a body corporate.

Technical log

10.—(1) A technical log shall be kept in respect of an aircraft registered in Hong Kong being an aircraft in respect of which a certificate of airworthiness in either the transport or in the aerial work category is in force or in respect of any other aircraft when the Governor so requires.

(2) At the end of every flight by an aircraft to which the provisions of this Article apply the commander of the aircraft shall enter:

- (a) the times when the aircraft took off and landed;
- (b) particulars of any defect which is known to him and which affects the airworthiness or safe operation of the aircraft, or if no such defect is known to him, an entry to that effect; and
- (c) such other particulars in respect of the airworthiness or operation of the aircraft as the Governor may require;

in a technical log, or, in the case of an aircraft of which the maximum total weight authorised does not exceed 2,730 kg and which is not operated by a person who is the holder of or is required by Article 6(1) of this Order to hold an air operator’s certificate in such other record as the Governor shall approve and he shall sign and date such entries:

Provided that in the case of a number of consecutive flights each of which begins and ends:

- (i) within the same period of 24 hours;
- (ii) at the same aerodrome, except where each such flight is for the purpose of dropping or projecting any material for agricultural, public health or similar purposes; and
- (iii) with the same person as commander of the aircraft;

the commander of an aircraft may, except where he becomes aware of a defect during an earlier flight, make the entries as aforesaid in a technical log at the end of the last of such consecutive flights.

(3) Upon the rectification of any defect which has been entered in a technical log in accordance with paragraph (2) of this Article a person issuing a certificate of release to service required by Article 11 of this Order in respect of that defect shall enter the certificate in the technical log in such a position as to be readily identifiable with the defect to which it relates.

(4) The technical log referred to in this Article shall be carried in the aircraft when Article 57 of this Order so requires and copies of the entries referred to in this Article shall be kept on the ground:

Provided that, in the case of an aeroplane of which the maximum total weight authorised does not exceed 2,730 kg, or a helicopter, if it is not reasonably practicable for the copy of the technical log to be kept on the ground it may be carried in the aeroplane or helicopter, as the case may be, in a container approved by the Governor for that purpose.

(5) Subject to the provisions of Article 61 of this Order, a technical log or such other approved record required by this Article shall be preserved by the operator of the aircraft to which it relates until a date two years after the aircraft has been destroyed or has been permanently withdrawn from use, or for such shorter period as the Governor may permit in a particular case.

Inspection, overhaul, repair, replacement and modification

11.—(1) Except as provided in paragraph (2) of this Article an aircraft registered in Hong Kong, being an aircraft in respect of which a certificate of airworthiness issued or rendered valid under this Order is in force, shall not fly unless there is in force a certificate (in this Order referred to as a “certificate of release to service”) issued in accordance with this Article if the aircraft or any part of the aircraft or such of its equipment as is necessary for the airworthiness of the aircraft has been overhauled, repaired, replaced, modified, maintained, or has been inspected as provided in Article 8(7)(b) of this Order, as the case may be:

Provided that if a repair or replacement of a part of an aircraft or its equipment is carried out when the aircraft is at such a place that it is not reasonably practicable:

- (a) for the repair or replacement to be carried out in such a manner that a certificate of release to service can be issued under this Article in respect thereof; or
- (b) for such certificate to be issued while the aircraft is at that place;

it may fly to a place at which such certificate can be issued, being the nearest place:

- (i) to which the aircraft can, in the reasonable opinion of the commander thereof, safely fly by a route for which it is properly equipped; and
- (ii) to which it is reasonable to fly having regard to any hazards to the liberty or health of any person on board;

and in such case the commander of the aircraft shall cause written particulars of the flight, and the reasons for making it, to be given to the Governor within ten days thereafter.

(2) Nothing in paragraph (1) of this Article shall require a certificate of release to service to be in force in respect of an aircraft of which the maximum total weight authorised does not exceed 2,730 kg and in respect of which a certificate of airworthiness of the special category is in force, unless the Governor gives a direction to the contrary in a particular case.

(3) Nothing in paragraph (1) of this Article shall prevent an aircraft in respect of which there is in force a certificate of airworthiness in the private or special categories and whose maximum total weight authorised does not exceed 2,730 kg from flying if the only repairs or replacements in respect of which a certificate of release to service is not in force are of such a description as are specified in Regulation 15 in Schedule 15 to this Order and have been carried out personally by the owner or operator of the aircraft being the holder of a pilot's licence granted or rendered valid under this Order. In that event the owner or operator, as the case may be, of the aircraft, shall keep in the aircraft log book kept in respect of the aircraft pursuant to Article 15 of this Order a record which identifies the repair or replacement and shall sign and date the entries and, subject to the provisions of Article 61 of this Order, shall preserve the log book for the period specified in Article 15 of this Order. Any equipment or parts used in carrying out such repairs or replacements shall be of a type approved by the Governor whether generally or in relation to a class of aircraft or one particular aircraft.

(4) Neither:

- (a) equipment provided in compliance with Schedule 5 to this Order (except paragraph (3) thereof); nor
- (b) radio apparatus provided for use in an aircraft or in any survival craft carried in an aircraft, whether or not such apparatus is provided in compliance with this Order or any regulations made thereunder;

shall be installed or placed on board for use in an aircraft registered in Hong Kong after being overhauled, repaired, modified or inspected, unless there is in force in respect thereof at the time when it is installed or placed on board a certificate of release to service issued in accordance with this Article.

(5) A certificate of release to service shall:

- (a) certify that the aircraft or any part thereof or its equipment has been overhauled, repaired, replaced, modified or maintained, as the case may be in a manner and with material of a type approved by the Governor either generally or in relation to a class of aircraft or the particular aircraft and shall identify the overhaul, repair, replacement, modification or maintenance to which the certificate relates and shall include particulars of the work done; or
- (b) certify in relation to any inspection required by the Governor that the aircraft or the part thereof or its equipment, as the case may be, has been inspected in accordance with the requirements of the Governor and that any consequential repair, replacement or modification has been carried out as aforesaid.

(6) A certificate of release to service may be issued for the purposes of this Article only by:

- (a) the holder of an aircraft maintenance engineer's licence:
 - (i) granted under this Order, being a licence which entitles him to issue that certificate;
 - (ii) granted under the law of a country other than Hong Kong and rendered valid under this Order, in accordance with the privileges endorsed on the licence; or
 - (iii) granted under the law of any country specified in Regulation 13 in Schedule 15 to this Order in accordance with the privileges endorsed on the licence and subject to any conditions which may be prescribed;
- (b) the holder of an aircraft maintenance engineer's licence or authorisation as such an engineer granted or issued by or under the law of any Contracting State other than Hong Kong in which the overhaul, repair, replacement, modification or inspection has been carried out, but only in respect of aircraft of which the maximum total weight authorised does not exceed 2,730 kg and in accordance with the privileges endorsed on the licence;
- (c) a person approved by the Governor as being competent to issue such certification, and in accordance with that approval;

- (d) a person whom the Governor has authorised to issue the certificate in a particular case, and in accordance with that authority; or
- (e) in relation only to the adjustment and compensation of direct reading magnetic compasses, the holder of an Airline Transport Pilot's Licence (Aeroplanes) or a Flight Navigator's Licence granted or rendered valid under this Order.

(7) Subject to the provisions of Article 61 of this Order, a certificate of release to service shall be preserved by the operator of the aircraft to which it relates for the period of time for which he is required to preserve the log book relating to the same part of the aircraft or to the same equipment or apparatus as the case may be.

(8) In this Article, the expression "repair" includes in relation to a compass the adjustment and compensation thereof and the expression "repaired" shall be construed accordingly.

(9) For the purpose of this Article "a person" may include a body corporate.

Licensing of maintenance engineers

12.—(1) The Governor shall grant aircraft maintenance engineer's licences, subject to such conditions as he thinks fit, upon his being satisfied that the applicant is a fit person to hold the licence and has furnished such evidence and passed such examinations and tests as the Governor may require of him for the purpose of establishing that he has sufficient knowledge, experience, competence and skill in aeronautical engineering.

(2) An aircraft maintenance engineer's licence shall authorise the holder, subject to such conditions as may be specified in the licence, to issue:

- (a) certificates of a maintenance review in respect of such aircraft as may be so specified;
- (b) certificates of release to service in respect of such overhauls, repairs, replacements, modifications, maintenance and inspections of such aircraft and such equipment as may be so specified; or
- (c) certificates of fitness for flight under "A Conditions" in respect of such aircraft as may be so specified.

(3) A licence shall, subject to the provisions of Article 62 of this Order, remain in force for the period specified therein, not exceeding five years, but may be renewed by the Governor from time to time upon his being satisfied that the applicant is a fit person and is qualified as aforesaid.

(4) The Governor may issue a certificate rendering valid for the purposes of this Order any licence as an aircraft maintenance engineer granted under the law of any country other than Hong Kong. Such certificate may be issued subject to such conditions, and for such period, as the Governor thinks fit.

(5) Upon receiving a licence granted under this Article, the holder shall forthwith sign his name thereon in ink with his ordinary signature.

(6) Without prejudice to any other provision of this Order the Governor may, for the purpose of this Article, either absolutely or subject to such conditions as he thinks fit:

- (a) approve any course of training or instruction;
- (b) authorise a person to conduct such examinations or tests as he may specify;
- (c) approve a person to provide or conduct any course of training or instruction; and
- (d) approve a person as qualified to furnish reports to him and to accept such reports.

Equipment of aircraft

13.—(1) An aircraft shall not fly unless it is so equipped as to comply with the law of the country in which it is registered, and to enable lights and markings to be displayed, and signals to be made in accordance with this Order and any regulations made thereunder.

(2) In the case of any aircraft registered in Hong Kong the equipment required to be provided (in addition to any other equipment required by or under this Order) shall be that specified in such parts of Schedule 5 to this Order as are applicable in the circumstances and shall comply with the provisions of that Schedule. The equipment, except that specified in paragraph (3) of the said Schedule, shall be of a type approved by the Governor either generally or in relation to a class of aircraft or in relation to that aircraft and shall be installed in a manner so approved.

(3) In any particular case the Governor may direct that an aircraft registered in Hong Kong shall carry such additional or special equipment or supplies as he may specify for the purpose of facilitating the navigation of the aircraft, the carrying out of search and rescue operations, or the survival of the persons carried in the aircraft.

(4) The equipment carried in compliance with this Article shall be so installed or stowed and kept stowed, and so maintained and adjusted, as to be readily accessible and capable of being used by the person for whose use it is intended.

(5) The position of equipment provided for emergency use shall be indicated by clear markings in or on the aircraft. In particular in every public transport aircraft registered in Hong Kong there shall be:

- (a) provided individually for each passenger; or
- (b) if the Governor so permits in writing, exhibited in a prominent position in every passenger compartment;

a notice relevant to the aircraft in question containing pictorial:

- (i) instructions on the brace position to be adopted in the event of an emergency landing;
- (ii) instructions on the method of use of the safety belts and safety harnesses as appropriate;
- (iii) information as to where emergency exits are to be found and instructions as to how they are to be used; and
- (iv) information as to where the life-jackets, escape slides, life-rafts and oxygen masks, if required to be provided by paragraph (2) of this Article, are to be found and instructions as to how they are to be used.

(6) All equipment installed or carried in an aircraft, whether or not in compliance with this Article, shall be so installed or stowed and so maintained and adjusted as not to be a source of danger in itself or to impair the airworthiness of the aircraft or the proper functioning of any equipment or services necessary for the safety of the aircraft.

(7) Without prejudice to paragraph (2) of this Article, all navigational equipment (other than radio apparatus) of any of the following types, namely:

- (a) equipment capable of establishing the aircraft's position in relation to its position at some earlier time by computing and applying the resultant of the acceleration and gravitational forces acting upon it; and
- (b) equipment capable of establishing automatically the altitude and relative bearing of selected celestial bodies;

when carried in an aircraft registered in Hong Kong (whether or not in compliance with this Order or any regulations made thereunder) shall be of a type approved by the Governor either generally or in relation to a class of aircraft or in relation to that aircraft and shall be installed in a manner so approved.

(8) This Article shall not apply in relation to radio apparatus except that specified in Schedule 5 to this Order.

Radio equipment of aircraft

14.—(1) An aircraft shall not fly unless it is so equipped with radio and radio navigation equipment as to comply with the law of the country in which the aircraft is registered and to enable communications to be made and the aircraft to be navigated, in accordance with the provisions of this Order including, in particular, Schedule 15 hereto.

(2) Without prejudice to paragraph (1) of this Article, the aircraft shall be equipped with radio and radio navigation equipment in accordance with Schedule 6 to this Order.

(3) In any particular case the Governor may direct that an aircraft registered in Hong Kong shall carry such additional or special radio or radio navigation equipment as he may specify for the purpose of facilitating the navigation of the aircraft, the carrying out of search and rescue operations or the survival of the persons carried in the aircraft.

(4) Subject to such exceptions as may be prescribed the radio and radio navigation equipment provided in compliance with this Article in an aircraft registered in Hong Kong shall always be maintained in serviceable condition.

(5) All radio and radio navigation equipment installed in an aircraft registered in Hong Kong or carried on such an aircraft for use in connection with the aircraft (whether or not in compliance with this Order or any regulations made thereunder) shall be of a type approved by the Governor in relation to the purpose for which it is to be used, and shall be installed in a manner approved by the Governor. Neither the equipment nor the manner in which it is installed shall be modified except with the approval of the Governor.

Aircraft, engine and propeller log books

15.—(1) In addition to any other log books required by or under this Order, the following log books shall be kept in respect of aircraft registered in Hong Kong:

- (a) an aircraft log book;
- (b) a separate log book in respect of each engine fitted in the aircraft; and
- (c) a separate log book in respect of each variable pitch propeller fitted to the aircraft.

The log books shall include the particulars respectively specified in Schedule 7 to this Order and in the case of an aircraft having a maximum total weight authorised not exceeding 2,730 kg shall be of a type approved by the Governor.

- (a) (2) (a) Each entry in the log book, other than such an entry as is referred to in sub-paragraphs 2(d)(ii) or 3(d)(ii) of Schedule 7 to this Order, shall be made as soon as practicable after the occurrence to which it relates, but in no event more than 7 days after the expiration of the certificate of maintenance review (if any) in force in respect of the aircraft at the time of the occurrence;
- (b) Each entry in the log book, being such an entry as is referred to in sub-paragraphs 2(d)(ii) or 3(d)(ii) of Schedule 7 to this Order shall be made upon each occasion that any maintenance, overhaul, repair, replacement, modification or inspection is undertaken on the engine or propeller as the case may be.

(3) Entries in a log book may refer to other documents, which shall be clearly identified, and any other documents so referred to shall be deemed, for the purposes of this Order, to be part of the log book.

(4) It shall be the duty of the operator of every aircraft in respect of which log books are required to be kept as aforesaid to keep them or cause them to be kept in accordance with the foregoing provisions of this Article.

(5) Subject to the provisions of Article 61 of this Order every log book shall be preserved by the operator of the aircraft until a date two years after the aircraft, the engine or the variable pitch propeller, as the case may be, has been destroyed or has been permanently withdrawn from use.

Aircraft weight schedule

16.—(1) Every flying machine and glider in respect of which a certificate of airworthiness issued or rendered valid under this Order is in force shall be weighed, and the position of its centre of gravity determined, at such times and in such manner as the Governor may require or approve in the case of that aircraft.

(2) Upon the aircraft being weighed as aforesaid the operator of the aircraft shall prepare a weight schedule showing:

- (a) either the basic weight of the aircraft, that is to say, the weight of the aircraft empty together with the weight of unusable fuel and unusable oil in the aircraft and of such items of equipment as are indicated in the weight schedule, or such other weight as may be approved by the Governor in the case of that aircraft; and
- (b) either the position of the centre of gravity of the aircraft when the aircraft contains only the items included in the basic weight or such other position of the centre of gravity as may be approved by the Governor in the case of that aircraft.

(3) Subject to the provisions of Article 61 of this Order the weight schedule shall be preserved by the operator of the aircraft until the expiration of a period of 6 months following the next occasion on which the aircraft is weighed for the purposes of this Article.

Access and inspection for airworthiness purposes

17. The Governor may cause such inspections, investigations, tests, experiments and flight trials to be made as he deems necessary for the purposes of this Part of this Order and any person authorised to do so in writing by the Governor may at any reasonable time inspect any part of, or material intended to be incorporated in or used in the manufacture of any part of, an aircraft or its equipment or any documents relating thereto and may for that purpose go upon any aerodrome or enter any aircraft factory.

PART IV

AIRCRAFT CREW AND LICENSING

Composition of crew of aircraft

18.—(1) An aircraft shall not fly unless it carries a flight crew of the number and description required by the law of the country in which it is registered.

(2) An aircraft registered in Hong Kong shall carry a flight crew adequate in number and description to ensure the safety of the aircraft and of at least the number and description specified in the certificate of airworthiness issued or rendered valid under this Order or, if no certificate of airworthiness is required under this Order to be in force, the certificate of airworthiness, if any, last in force under this Order, in respect of that aircraft.

- (a) (3) (a) A flying machine registered in Hong Kong and flying for the purpose of public transport having a maximum total weight authorised exceeding 5,700 kg, shall carry not less than two pilots as members of the flight crew thereof.
- (b) An aeroplane registered in Hong Kong and flying for the purpose of public transport in circumstances where the aircraft commander is required to comply with Instrument Flight

Rules and having a maximum total weight authorised of 5,700 kg, or less and powered by:—

- (i) one or more turbine jets;
- (ii) one or more turbine propeller engines and provided with a means of pressurising the personnel compartments;
- (iii) two or more turbine propeller engines and certificated to carry more than nine passengers;
- (iv) two or more turbine propeller engines and certificated to carry fewer than ten passengers and not provided with a means of pressurising the personnel compartments unless it is equipped with an auto-pilot which has been approved by the Governor for the purposes of this Article and which is serviceable on take-off; or
- (v) two or more piston engines unless it is equipped with an auto-pilot which has been approved by the Governor for the purposes of this Article and which is serviceable on take-off;

shall carry not less than two pilots as members of the flight crew thereof:

Provided that an aeroplane powered by two or more turbine propeller engines and certificated to carry fewer than ten passengers or an aeroplane powered by two or more piston engines and equipped with an appropriate auto-pilot shall not be required to carry two pilots notwithstanding that before take-off the approved auto-pilot is found to be unserviceable if the aeroplane flies in accordance with arrangements approved by the Governor.

(4) An aircraft registered in Hong Kong engaged on a flight for the purpose of public transport shall carry:

- (a) a flight navigator as a member of the flight crew; or
- (b) navigational equipment approved by the Governor and used in accordance with any conditions subject to which that approval may have been given;

if on the route or any diversion therefrom, being a route or diversion planned before take-off, the aircraft is intended to be more than 500 nautical miles from the point of take-off measured along the route to be flown, and to pass over part of an area specified in Schedule 8 to this Order. The flight navigator carried in compliance with this Article shall be carried in addition to any person who is carried in accordance with this Article to perform other duties.

(5) An aircraft registered in Hong Kong which is required by the provisions of Article 14 of this Order to be equipped with radio communication apparatus shall carry a flight radio operator as a member of the flight crew, who, if he is required to operate radiotelegraph apparatus, shall be carried in addition to any other person who is carried in accordance with this Article to perform other duties.

(6) If it appears to him to be expedient to do so in the interests of safety, the Governor may direct any particular operator of any aircraft registered in Hong Kong that the aircraft operated by him or any such aircraft shall not fly in such circumstances as the Governor may specify unless those aircraft carry in addition to the flight crew required to be carried therein by the foregoing provisions of this Article such additional persons as members of the flight crew as he may specify in the direction.

(a) (7) (a) This paragraph applies to any flight for the purpose of public transport by an aircraft registered in Hong Kong:

- (i) on which is carried twenty or more passengers; or
- (ii) which may in accordance with its certificate of airworthiness carry more than thirty-five passengers and on which at least one passenger is carried.

(b) The crew of an aircraft on a flight to which this paragraph applies shall include cabin attendants carried for the purposes of performing in the interests of the safety of

passengers, duties to be assigned by the operator or the commander of the aircraft but who shall not act as members of the flight crew.

- (c) On a flight to which this paragraph applies, there shall be carried not less than one cabin attendant for every fifty, or fraction of fifty passenger seats installed in the aircraft:

Provided that the number of cabin attendants calculated in accordance with this sub-paragraph need not be carried where the Governor has granted written permission to the operator to carry a lesser number on that flight and the operator carries the number specified in that permission and complies with any other terms and conditions subject to which such permission is granted.

(8) If it appears to him to be expedient to do so in the interests of safety, the Governor may direct any particular operator of any aircraft registered in Hong Kong that the aircraft operated by him or any such aircraft shall not fly in such circumstances as the Governor may specify unless those aircraft carry in addition to the cabin attendants required to be carried therein by the foregoing provisions of this Article such additional persons as cabin attendants as he may specify in the direction.

Members of flight crew—requirement of licences

19.—(1) Subject to the provisions of this Article, a person shall not act as a member of the flight crew of an aircraft registered in Hong Kong unless he is the holder of an appropriate licence granted or rendered valid under this Order:

Provided that a person may within Hong Kong without being the holder of such a licence—

- (a) act as a flight radiotelephony operator if—
- (i) he does so as the pilot of a glider not flying for the purpose of public transport or aerial work, or as a person being trained in an aircraft registered in Hong Kong to perform duties as a member of the flight crew of an aircraft; and
 - (ii) he is authorised to operate the radiotelephony station by the holder of the licence granted in respect of that station under any enactment; and
 - (iii) messages are transmitted only for the purposes of instruction, or of the safety or navigation of the aircraft; and
 - (iv) messages are transmitted only on a frequency exceeding 60 MHz assigned by the Governor for use on flights on which a flight radiotelephony operator acts in one of the capacities specified in paragraph (i) of this proviso; and
 - (v) the transmitter is pre-set to one or more of the frequencies so assigned and cannot be adjusted in flight to any other frequency; and
 - (vi) the operation of the transmitter requires the use only of external switches; and
 - (vii) the stability of the frequency radiated is maintained automatically by the transmitter;
- (b) subject to the provisions of Article 20(8) of this Order, act as pilot in command of an aircraft for purpose of becoming qualified for the grant or renewal of a pilot's licence or the inclusion or variation of any rating in a pilot's licence if—
- (i) he is at least 17 years of age; and
 - (ii) he is the holder of a valid medical certificate to the effect that he is fit so to act issued by a person approved by the Governor; and
 - (iii) he complies with any conditions subject to which that medical certificate was issued; and
 - (iv) no other person is carried in the aircraft; and

- (v) the aircraft is not flying for the purpose of public transport or aerial work other than aerial work which consists of the giving of instruction in flying or the conducting of flying tests; and
 - (vi) he so acts in accordance with instructions given by a person holding a pilot's licence granted under this Order being a licence which includes a flying instructor's rating or an assistant flying instructor's rating entitling him to give instruction in flying the type of aircraft being flown;
- (c) subject to the provisions of Article 20(8) of this Order, act as pilot of an aircraft in respect of which the flight crew required to be carried by or under this Order does not exceed one pilot for the purpose of becoming qualified for the grant or renewal of a pilot's licence or the inclusion or variation of any rating in a pilot's licence if—
- (i) the aircraft is not flying for the purpose of public transport or aerial work other than aerial work which consists of the giving of instruction in flying or the conducting of flying tests; and
 - (ii) he so acts in accordance with instructions given by a person holding a pilot's licence granted under this Order being a licence which includes a flying instructor's rating or an assistant flying instructor's rating entitling him to give instruction in flying the type of aircraft being flown; and
 - (iii) the aircraft is fitted with dual controls and he is accompanied in the aircraft by the said instructor who is seated at the other set of controls or the aircraft is fitted with controls designed for and capable of use by two persons and he is accompanied in the aircraft by the said instructor who is seated so as to be able to use the controls;
- (d) subject to the provisions of Article 20(8) of this Order, act as pilot in command of an aircraft at night if—
- (i) he is the holder of an appropriate licence granted or rendered valid under this Order in all respects save that the licence does not include an instrument rating and he has not within the immediately preceding thirteen months carried out as pilot in command not less than five take-offs and landings at a time when the depression of the centre of the sun was not less than 12° below the horizon;
 - (ii) he so acts in accordance with instructions given by a person holding a pilot's licence granted under this Order being a licence which includes a flying instructor's rating or an assistant flying instructor's rating entitling him to give instruction in flying the type of aircraft being flown by night;
 - (iii) no person other than that specified in sub-paragraph (ii) above is carried; and
 - (iv) the aircraft is not flying for the purpose of public transport or aerial work other than aerial work which consists of the giving of instruction in flying or the conducting of flying tests.
- (2) Subject as aforesaid, a person shall not act as a member of the flight crew required by or under this Order to be carried in an aircraft registered in a country other than Hong Kong unless—
- (a) in the case of an aircraft flying for the purpose of public transport or aerial work he is the holder of an appropriate licence granted or rendered valid under the law of the country in which the aircraft is registered; or
 - (b) in the case of any other aircraft, he is the holder of an appropriate licence granted or rendered valid under the law of the country in which the aircraft is registered or under this Order, and the Governor does not in the particular case give a direction to the contrary.
- (3) For the purposes of this Article, a licence granted under the law of a Contracting State other than Hong Kong purporting to authorise the holder thereof to act as a member of the flight crew of an aircraft, not being a licence purporting to authorise him to act as a student pilot only, shall,

unless the Governor in the particular case gives a direction to the contrary, be deemed to be a licence rendered valid under this Order but does not entitle the holder—

- (a) to act as a member of the flight crew of any aircraft flying for the purpose of public transport or aerial work or on any flight in respect of which he receives remuneration for his services as a member of the flight crew; or
- (b) in the case of a pilot's licence, to act on any flight as pilot of any aircraft flying in controlled airspace in circumstances requiring compliance with the Instrument Flight Rules or to give any instruction in flying.

(4) Notwithstanding the provisions of paragraph (1) of this Article, a person may, unless the certificate of airworthiness in force in respect of the aircraft otherwise requires, act as pilot of an aircraft registered in Hong Kong for the purpose of undergoing training or tests for the grant or renewal of a pilot's licence or for the inclusion, renewal or extension of a rating therein without being the holder of an appropriate licence, if the following conditions are complied with:

- (a) no other person shall be carried in the aircraft or in an aircraft being towed thereby except a person carried as a member of the flight crew in compliance with this Order, a person authorised by the Governor to witness the aforesaid training or tests or to conduct the aforesaid tests, or, if the pilot in command of the aircraft is the holder of an appropriate licence, a person carried for the purpose of being trained or tested as a member of the flight crew of an aircraft; and
- (b) the person acting as the pilot of the aircraft without being the holder of an appropriate licence either—
 - (i) within the period of 6 months immediately preceding was serving as a qualified pilot of aircraft in any of Her Majesty's naval, military or air forces, and his physical condition has not, so far as he is aware, so deteriorated during that period as to render him unfit for the licence for which he intends to qualify; or
 - (ii) holds a pilot's, a flight navigator's or a flight engineer's licence granted or rendered valid under this Order and the purpose of the training or test is to enable him to qualify under this Order for the grant of a pilot's licence or for the inclusion of an additional type in the aircraft rating in his licence and he acts under the supervision of a person who is the holder of an appropriate licence.

(5) Notwithstanding the provisions of paragraph (1) of this Article a person may act as a member of the flight crew (otherwise than as a pilot) of an aircraft registered in Hong Kong for the purposes of undergoing training or tests for the grant or renewal of a flight navigator's or a flight engineer's licence or for the inclusion, renewal or extension of a rating thereon, without being the holder of an appropriate licence if he acts under supervision and in the presence of another person who is the holder of the type of licence or rating for which the person undergoing the training or tests is being trained or tested.

(6) Notwithstanding the provisions of paragraph (1) of this Article, a person may act as a member of the flight crew of an aircraft registered in Hong Kong without being the holder of an appropriate licence if, in so doing, he is acting in the course of his duty as a member of any of Her Majesty's naval, military or air forces.

(7) An appropriate licence for the purposes of this Article means a licence which entitles the holder to perform the functions which he undertakes in relation to the aircraft concerned and the flight on which it is engaged.

(8) This Article shall not require a licence to be held by a person by reason of his acting as a member of the flight crew of a glider unless:

- (a) he acts as a flight radio operator, or

- (b) the flight is for the purpose of public transport or aerial work, other than aerial work which consists of the giving of instruction in flying in a glider owned or operated by a flying club of which the person giving and the person receiving instruction are both members.
- (9) Notwithstanding anything in this Article—
 - (a) the holder of a licence granted or rendered valid under this Order, being a licence endorsed to the effect that the holder does not satisfy in full the relevant international standard, shall not act as a member of the flight crew of an aircraft registered in Hong Kong in or over the territory of a Contracting State other than Hong Kong, except in accordance with permission granted by the competent authorities of that State;
 - (b) the holder of a licence granted or rendered valid under the law of a Contracting State other than Hong Kong, being a licence endorsed as aforesaid, shall not act as a member of the flight crew of any aircraft in or over Hong Kong except in accordance with permission granted by the Governor, whether or not the licence is or is deemed to be rendered valid under this Order.

Grant, renewal and effect of Flight Crew Licences

- (a) **20.** (1) (a) The Governor may grant licences, subject to such conditions as he thinks fit, of any of the classes specified in Part A of Schedule 9 to this Order authorising the holder to act as a member of the flight crew of an aircraft registered in Hong Kong, upon his being satisfied that the applicant is a fit person to hold the licence, and is qualified by reason of his knowledge, experience, competence, skill, physical and mental fitness to act in the capacity to which the licence relates, and for that purpose the applicant shall furnish such evidence and undergo such examinations and tests (including in particular medical examinations) and undertake such courses of training as the Governor may require of him.
- (b) A licence of any class shall not be granted to any person who is under the minimum age specified for that class of licence in Part A of the said Schedule.
- (c) A licence granted under this Article shall not be valid unless it bears thereon the ordinary signature of the holder in ink.
- (d) Subject to paragraph (1)(a) of this Article and to the provisions of Article 62 of this Order, a licence shall remain in force for the period indicated in the licence not exceeding the period specified in respect of a licence of that class in the said Schedule, and may be renewed by the Governor from time to time upon his being satisfied that the applicant is a fit person and qualified as aforesaid. If no period is indicated in the licence, it shall remain in force subject as aforesaid, for the lifetime of the holder.

Provided that, until 1st December 1996, the said Part A of Schedule 9 shall be applied as if—

- (i) in the privileges of the Commercial Pilot's Licence (Aeroplanes), proviso (e) to paragraph (2), the proviso to paragraph (3) and paragraph (4) were omitted;
- (ii) the privileges of the Airline Transport Pilot's Licence (Aeroplanes) were amended to read—"the holder of the licence shall be entitled to exercise the privileges of a Commercial Pilot's Licence (Aeroplanes) except that for proviso (d) to paragraph (2) of those privileges, there shall be substituted—
 - (d) he shall not at any time after he attains the age of 60 years fly such an aeroplane for the purpose of public transport if its maximum total weight authorised exceeds 20,000 kg.";
- (iii) in the privileges of the Commercial Pilot's Licence (Helicopters and Gyroplanes), proviso (e) to paragraph (2), the proviso to paragraph (3) and paragraph (4) were omitted; and

- (iv) in the privileges of the Airline Transport Pilot's Licence (Helicopters and Gyroplanes), all the words after "shall not apply" were omitted.

(2) The Governor may include in a licence a rating, subject to such conditions as he thinks fit, of any of the classes specified in Part B of the said Schedule, upon his being satisfied that the applicant is qualified as aforesaid to act in the capacity to which the rating relates, and such rating shall be deemed to form part of the licence.

(3) Subject to any conditions of the licence and to the provisions of this Order, a licence of any class shall entitle the holder to perform the functions specified in respect of that licence in Part A of the said Schedule under the heading "privileges", and a rating of any class shall entitle the holder of the licence in which such rating is included to perform the functions specified in respect of that rating in Part B of the said Schedule.

- (a) (4) (a) Subject to the provisions of sub-paragraph (c) of this paragraph, the holder of a pilot's licence or a flight engineer's licence shall not be entitled to exercise the privileges of an aircraft rating contained in the licence on a flight unless the licence bears a valid certificate of test or a valid certificate of experience, which certificate shall in either case be appropriate to the functions he is to perform on that flight in accordance with Part C of the said Schedule and shall otherwise comply with that Part:

Provided that the holder of a Private Pilot's Licence (Balloons and Airships) or a Commercial Pilot's Licence (Balloons) shall be entitled to exercise the privileges of an aircraft rating contained in the licence on a flight when the licence does not bear such a certificate.

- (b) The holder of a flight navigator's licence shall not be entitled to perform functions on a flight to which Article 18(4) of this Order applies unless the licence bears a valid certificate of experience which certificate shall be appropriate to the functions he is to perform on that flight in accordance with Part C of Schedule 9 and shall otherwise comply with that Part.
- (c) In any case where the Private Pilot's Licence is in such a form that it is not possible to include certificates therein, the holder of such a licence shall not be entitled to exercise the privileges of an aircraft rating contained in the licence on a flight unless the certificate of test or certificate of experience required by sub-paragraph (a) of this paragraph is included in the personal flying log book required to be kept by him under Article 22 of this Order.

(5) A person shall not be entitled to perform the functions to which an instrument rating (aeroplanes), an instrument rating (helicopters), a flying instructor's rating or an assistant flying instructor's rating relates unless his licence bears a valid certificate of test which certificate shall be appropriate to the functions to which the rating relates in accordance with Part C of the said Schedule and shall otherwise comply with that Part.

(6) A person who, on the last occasion when he took a test for the purposes of paragraphs (4) or (5) of this Article, failed that test shall not be entitled to fly in the capacity for which that test would have qualified him had he passed it.

- (a) (7) (a) The holder of a licence, other than a flight radiotelephony operator's licence, granted under this Article shall not be entitled to perform any of the functions to which his licence relates unless it includes a valid medical certificate.
- (b) Every applicant for or holder of such a licence shall upon such occasions as the Governor may require submit himself to medical examination by a person approved by the Governor either generally or in a particular case or class of case who shall make a report to the Governor in such form as the Governor may require.
- (c) Where the medical examination referred to in sub-paragraph (b) of this paragraph has been conducted in Hong Kong, the Governor or any person approved by him as competent to do so may, on the basis thereof, issue a medical certificate subject to such conditions as he thinks fit to the effect that he has assessed the holder of the licence as fit to

perform the functions to which the licence relates. The certificate shall without prejudice to paragraph (8) of this Article, be valid for such period as is therein specified and shall be deemed to form part of the licence.

- (d) Where the medical examination is conducted outside Hong Kong, the person conducting the examination shall, in addition to making a report to the Governor, issue a certificate certifying, if such is, in his opinion, the case, that the holder of the licence is fit to perform the functions to which the licence relates and the said certificate may be deemed by the Governor to be a medical certificate for the purposes of this Article, and if so shall be valid for such period as may be specified therein in writing by the person conducting the examination.
- (a) (8) (a) A person shall not be entitled to act as a member of the flight crew of an aircraft registered in Hong Kong if he knows or suspects that his physical or mental condition renders him temporarily or permanently unfit to perform such functions or to act in such capacity.
- (b) Every holder of a medical certificate issued under Article 19 or 20 of this Order who—
 - (i) suffers any personal injury involving incapacity to undertake his functions as a member of the flight crew; or
 - (ii) suffers any illness involving incapacity to undertake those functions throughout a period of 20 days or more; or
 - (iii) in the case of a woman, has reason to believe that she is pregnant:
 - shall inform the Governor in writing of such injury, illness or pregnancy, as soon as possible in the case of injury or pregnancy, and as soon as the period of 20 days has elapsed in the case of illness. The medical certificate shall be deemed to be suspended upon the occurrence of such injury or the elapse of such period of illness or the confirmation of the pregnancy, and—
 - (aa) in the case of injury or illness the suspension shall cease upon the holder being medically examined under arrangements made by the Governor and pronounced fit to resume his functions as a member of the flight crew or upon the Governor exempting, subject to such conditions as he thinks fit, the holder from the requirement of a medical examination; and
 - (bb) in the case of pregnancy, the suspension may be lifted by the Governor for such period and subject to such conditions as he thinks fit and shall cease upon the holder being medically examined under arrangements made by the Governor after the pregnancy has ended and pronounced fit to resume her functions as a member of the flight crew.

(9) Nothing in this Order shall prohibit the holder of a pilot's licence from acting as pilot of an aircraft having a maximum total weight authorised not exceeding 5,700 kg when, with the permission of the Governor, he is testing any person for the purposes of paragraphs (1), (2), (4) or (5) of this Article, notwithstanding that the type of aircraft in which the test is conducted is not specified in the aircraft rating included in his licence or that the licence or personal flying log book, as the case may be, does not include a valid certificate of test or a valid certificate of experience in respect of the type of aircraft.

(10) Where any provision of Part C of Schedule 9 or Part B of Schedule 11 to this Order permits a test to be conducted in a flight simulator approved by the Governor, that approval may be granted subject to such conditions as the Governor thinks fit.

(11) Without prejudice to any other provision of this Order the Governor may, for the purpose of this Article, either absolutely or subject to such conditions as he thinks fit—

- (a) approve any course of training or instruction;

- (b) authorise a person to conduct such examinations or tests as he may specify;
- (c) approve a person to provide any course of training or instruction; and
- (d) approve a person as qualified to furnish reports to him and to accept such reports.

Validation of licences

21. The Governor may issue a certificate of validation rendering valid for the purposes of this Order any licence as a member of the flight crew of aircraft granted under the law of any country other than Hong Kong. A certificate of validation may be issued subject to such conditions and for such periods as the Governor thinks fit.

Personal flying log book

22.—(1) Every Member of the flight crew of an aircraft registered in Hong Kong and every person who engages in flying for the purpose of qualifying for the grant or renewal of a licence under this Order shall keep a personal flying log book in which the following particulars shall be recorded—

- (a) the name and address of the holder of the log book;
- (b) particulars of the holder's licence (if any) to act as member of the flight crew of an aircraft;
- (c) the name and address of his employer (if any).

(2) Particulars of each flight during which the holder of the log book acted either as a member of the flight crew of an aircraft or for the purpose of qualifying for the grant or renewal of a licence under this Order as the case may be, shall be recorded in the log book at the end of each flight or as soon thereafter as is reasonably practicable, including—

- (a) the date, the places at which the holder embarked on and disembarked from the aircraft and the time spent during the course of a flight when he was acting in either capacity;
- (b) the type and registration mark of the aircraft;
- (c) the capacity in which the holder acted in flight;
- (d) particulars of any special conditions under which the flight was conducted, including night-flying and instrument flying; and
- (e) particulars of any test or examination undertaken whilst in flight.

(3) For the purposes of this Article, a helicopter shall be deemed to be in flight from the moment the helicopter first moves under its own power for the purpose of taking off until the rotors are next stopped.

(4) Particulars of any test or examination undertaken whilst in a flight simulator shall be recorded in the log book, including—

- (a) the date of the test or examination;
- (b) the type of simulator;
- (c) the capacity in which the holder acted; and
- (d) the nature of the test or examination.

Instruction in flying

23.—(1) A person shall not give any instruction in flying to which this Article applies unless—

- (a) he holds a licence, granted or rendered valid under this Order, entitling him to act as pilot in command of the aircraft for the purpose and in the circumstances under which the instruction is to be given; and

- (b) his licence includes a flying instructor's rating or an assistant flying instructor's rating entitling the holder to give the instruction.
- (2) This Article applies to instruction in flying given to any person flying or about to fly a flying machine or glider for the purpose of becoming qualified for—
 - (a) the grant of a pilot's licence;
 - (b) the inclusion or variation of any rating in his licence:

Provided that this Article shall not apply to any instruction in flying given to a person for the purpose of becoming qualified for the inclusion in his licence of an aircraft rating entitling him to act as pilot of a multi-engined aircraft, or of an aircraft of any class appearing in column 4 of the Table in Part A of Schedule 1 to this Order if that person has previously been entitled under the Order, or qualified in any of Her Majesty's naval, military or air forces, to act as pilot of multi-engined aircraft, or of an aircraft of that class as the case may be.

Glider pilot—minimum age

- 24. —A person under the age of 16 years shall not act as pilot in command of a glider.

PART V

OPERATION OF AIRCRAFT

Operations Manual

- 25.—(1) This Article shall apply to public transport aircraft registered in Hong Kong except aircraft whose maximum total weight authorised does not exceed 2,730 kg and which are used for the time being solely for flights not intended to exceed 60 minutes in duration, which are either—
 - (a) flights solely for training persons to perform duties in an aircraft; or
 - (b) flights intended to begin and end at the same aerodrome.
- (a) (2) (a) The operator of every aircraft to which this Article applies shall—
 - (i) make available to each member of his operating staff an operations manual, and
 - (ii) ensure that each copy of the operations manual is kept up to date, and
 - (iii) ensure that on each flight every member of the crew has access to a copy of every part of the operations manual which is relevant to his duties on the flight.
- (b) Each operations manual shall contain all such information and instructions as may be necessary to enable the operating staff to perform their duties as such including in particular information and instructions relating to the matters specified in Part A of Schedule 11 to this Order:

Provided that the operations manual shall not be required to contain any information or instructions available in a flight manual accessible to the persons by whom the information or instructions may be required.

- (a) (3) (a) An aircraft to which this Article applies shall not fly unless, not less than 30 days prior to such flight, the operator of the aircraft has furnished to the Governor a copy of the whole of the operations manual for the time being in effect in respect of the aircraft.
- (b) Any amendments or additions to the operations manual shall be furnished to the Governor by the operator before or immediately after they come into effect:

Provided that, where an amendment or addition relates to the operation of an aircraft to which the operations manual did not previously relate, that aircraft shall not fly for

the purpose of public transport until the amendment or addition has been furnished to the Governor.

- (c) Without prejudice to the foregoing sub-paragraphs the operator shall make such amendments or additions to the operations manual as the Governor may require for the purpose of ensuring the safety of the aircraft or of persons or property carried therein or the safety, efficiency or regularity of air navigation.

(4) For the purposes of this Article, Article 42 and Schedule 11 to this Order, “operating staff” means the servants and agents employed by the operator, whether or not as members of the crew of the aircraft, to ensure that the flights of the aircraft are conducted in a safe manner and includes an operator who himself performs those functions.

(5) If in the course of a flight on which the equipment specified in Scale O in paragraph 5 of Schedule 5 hereto is required to be provided the said equipment becomes unserviceable, the aircraft shall be operated on the remainder of that flight in accordance with any relevant instructions in the operations manual.

Training manual

26.—(1) The operator of every aircraft registered in Hong Kong and flying for the purpose of public transport shall:

- (a) make a training manual available to every person appointed by the operator to give or to supervise the training, experience, practice or periodical tests required under Article 27(2) of this Order; and
- (b) ensure that each copy of that training manual is kept up to date.

(2) Each training manual shall contain all such information and instructions as may be necessary to enable a person appointed by the operator to give or to supervise the training, experience, practice and periodical tests required under Article 27(2) of this Order to perform his duties as such including in particular information and instructions relating to the matters specified in Part C of Schedule 11 to this Order.

- (a) (3) (a) An aircraft to which this Article applies shall not fly unless, not less than 30 days prior to such flight, the operator of the aircraft has furnished to the Governor a copy of the whole of his training manual relating to the crew of that aircraft.
- (b) Any amendments or additions to the training manual shall be furnished to the Governor by the operator before or immediately after they come into effect:

Provided that where an amendment or addition relates to training, experience, practice or periodical tests on an aircraft to which the training manual did not previously relate, that aircraft shall not fly for the purpose of public transport until the amendment or addition has been furnished to the Governor.

- (c) Without prejudice to the foregoing sub-paragraphs the operator shall make such amendments or additions to the training manual as the Governor may require for the purpose of ensuring the safety of the aircraft or of persons or property carried therein or the safety, efficiency or regularity of air navigation.

Public transport—operator’s responsibilities

27.—(1) The operator of an aircraft registered in Hong Kong shall not permit the aircraft to fly for the purpose of public transport without first—

- (a) designating from among the flight crew a pilot to be the commander of the aircraft for the flight; and

- (b) satisfying himself by every reasonable means that the aeronautical radio stations and navigational aids serving the intended route or any planned diversion therefrom are adequate for the safe navigation of the aircraft; and
- (c) satisfying himself by every reasonable means that the aerodromes at which it is intended to take-off or land and any alternate aerodrome at which a landing may be made are suitable for the purpose and in particular are adequately manned and equipped (including such manning and equipment as is specified in Regulation 14 in Schedule 15 to this Order) to ensure the safety of the aircraft and its passengers:

Provided that the operator of the aircraft shall not be required to satisfy himself as to the adequacy of fire-fighting, search, rescue or other services which are required only after the occurrence of an accident.

(2) The operator of an aircraft registered in Hong Kong shall not permit any person to be a member of the crew thereof during any flight for the purpose of public transport (except a flight for the sole purpose of training persons to perform duties in aircraft) unless such person has had the training, experience, practice and periodical tests specified in Part B of Schedule 11 to this Order in respect of the duties which he is to perform and unless the operator has satisfied himself that such person is competent to perform his duties, and in particular to use the equipment provided in the aircraft for that purpose. The operator shall maintain, preserve, produce and furnish information respecting records relating to the foregoing matters in accordance with Part B of the said Schedule 11.

(3) The operator of an aircraft registered in Hong Kong shall not permit any member of the flight crew thereof, during any flight for the purpose of the public transport of passengers, to simulate emergency manoeuvres and procedures which the operator has reason to believe will adversely affect the flight characteristics of the aircraft.

Loading—public transport aircraft and suspended loads

28.—(1) The operator of an aircraft registered in Hong Kong shall not cause or permit it to be loaded for a flight for the purpose of public transport, or any load to be suspended therefrom, except under the supervision of a person whom he has caused to be furnished with written instructions as to the distribution and securing of the load so as to ensure that—

- (a) the load may safely be carried on the flight; and
- (b) any conditions subject to which the certificate of airworthiness in force in respect of the aircraft was issued or rendered valid, being conditions relating to the loading of the aircraft, are complied with.

(2) The instructions shall indicate the weight of the aircraft prepared for service, that is to say the aggregate of the weight of the aircraft (shown in the weight schedule referred to in Article 16 of this Order) and the weight of such additional items in or on the aircraft as the operator thinks fit to include; and the instructions shall indicate the additional items included in the weight of the aircraft prepared for service, and show the position of the centre of gravity of the aircraft at that weight:

Provided that this paragraph shall not apply in relation to a flight if—

- (a) the aircraft's maximum total weight authorised does not exceed 1,150 kg; or
- (b) the aircraft's maximum total weight authorised does not exceed 2,730 kg and the flight is intended not to exceed 60 minutes in duration and is either—
 - (i) a flight solely for training persons to perform duties in an aircraft; or
 - (ii) a flight intended to begin and end at the same aerodrome; or
- (c) the aircraft is a helicopter the maximum total weight authorised of which does not exceed 3,000 kg and the total seating capacity of which does not exceed five persons.

(3) The operator of an aircraft shall not cause or permit it to be loaded in contravention of the instructions referred to in paragraph (1) of this Article.

(4) The person supervising the loading of the aircraft shall, before the commencement of any such flight, prepare and sign a load sheet in duplicate conforming to the requirements specified in Regulation 1 in Schedule 15 to this Order, and shall (unless he is himself the commander of the aircraft) submit the load sheet for examination by the commander of the aircraft who shall sign his name thereon:

Provided that the foregoing requirements of this paragraph shall not apply if—

- (a) the load and the distributing and securing thereof upon the next intended flight are to be unchanged from the previous flight and the commander of the aircraft makes and signs an endorsement to that effect upon the load sheet for the previous flight, indicating the date of the endorsement, the place of departure upon the next intended flight and the next intended place of destination; or
- (b) paragraph (2) of this Article does not apply in relation to the flight.

(5) One copy of the load sheet shall be carried in the aircraft when Article 57 of this Order so requires until the flights to which it relates have been completed and one copy of that load sheet and of the instructions referred to in this Article shall be preserved by the operator until the expiration of a period of six months thereafter and shall not be carried in the aircraft:

Provided that in the case of an aeroplane of which the maximum total weight authorised does not exceed 2,730 kg, or a helicopter, if it is not reasonably practicable for the copy of the load sheet to be kept on the ground it may be carried in the aeroplane or helicopter, as the case may be, in a container approved by the Governor for that purpose.

(6) The operator of an aircraft registered in Hong Kong and flying for the purpose of the public transport of passengers shall not cause or permit baggage to be carried in the passenger compartment of the aircraft unless such baggage can be properly secured and, in the case of an aircraft capable of seating more than 30 passengers, such baggage shall not exceed the capacity of the spaces in the passenger compartment approved by the Governor for the purpose of stowing baggage, unless carried in accordance with the terms of a written permission granted by the Governor which permission may be granted subject to such conditions as the Governor thinks fit.

Public transport—operating conditions

29.—(1) An aircraft registered in Hong Kong shall not fly for the purpose of public transport, except for the sole purpose of training persons to perform duties in aircraft, unless the relevant requirements specified in Regulations 3 to 11 inclusive in Schedule 15 to this Order in respect of its weight and related performance and flight in specified meteorological conditions or at night are complied with.

(2) The assessment of the ability of an aircraft to comply with paragraph (1) of this Article shall be based on the information as to its performance contained in the certificate of airworthiness relating to the aircraft. In the event of the information given therein being insufficient for that purpose such assessment shall be based on the best information available to the commander of the aircraft.

(3) A flying machine registered in Hong Kong when flying over water for the purpose of public transport shall fly, except as may be necessary for the purpose of take-off or landing, at such an altitude as would enable the aircraft—

- (a) if it has one engine only, in the event of the failure of that engine; or
- (b) if it has more than one engine, in the event of the failure of one of those engines, and with the remaining engine or engines operating within the maximum continuous power conditions specified in the certificate of airworthiness relating to the aircraft;

to reach a place at which it can safely land at a height sufficient to enable it to do so.

(4) Without prejudice to the provisions of paragraph (3) of this Article, an aeroplane in respect of which there is in force under this Order a certificate of airworthiness designating the aeroplane as being of performance group X shall not fly over water for the purpose of public transport so as to be more than 60 minutes flying time from the nearest shore, unless the aeroplane has more than two power units. For the purposes of this paragraph, flying time shall be calculated at normal cruising speed with one power unit inoperative.

(5) Without prejudice to the provisions of paragraph (3) of this Article, a helicopter in respect of which there is in force under this Order a certificate of airworthiness designating the helicopter as being of performance group B shall not fly over water for the purpose of public transport so as to be more than 20 seconds flying time from a point from which it can make an autorotative descent to land suitable for an emergency landing unless it is equipped with apparatus approved by the Governor enabling it to land safely on water, but shall not so fly on any flight for more than three minutes except with the permission in writing of the Governor and in accordance with any conditions subject to which that permission may have been given. For the purpose of this paragraph, flying time shall be calculated on the assumption that the helicopter is flying in still air at the speed specified in the certificate of airworthiness in force in respect of the helicopter as the speed for compliance with regulations governing flights over water.

(6) Without prejudice to the provisions of paragraph (3) of this Article, a helicopter in respect of which there is in force under this Order a certificate of airworthiness designating the helicopter as being of performance group A2 shall not fly over water for the purpose of public transport for more than 15 minutes during any flight unless it is equipped with apparatus approved by the Governor enabling it to land safely on water.

(7) Notwithstanding the provisions of paragraph (1) of this Article a helicopter in respect of which there is in force under this Order a Certificate of Airworthiness designating the helicopter as being of performance Group A or Group A (Restricted) may fly for the purpose of public transport in accordance with the weight and related performance requirements prescribed for helicopters designated as being of:—

- (a) performance Group A (Restricted) in the case of a helicopter designated as being of performance Group A if:
 - (i) the maximum total weight authorised of the helicopter is less than 5,700 kg; and
 - (ii) the total number of passengers carried on the helicopter does not exceed 15; or
- (b) performance Group B if:
 - (i) the maximum total weight authorised of the helicopter is less than 2,730 kg; and
 - (ii) the total number of passengers carried does not exceed 9.

Aircraft registered in Hong Kong—Aerodrome operating minima

- (a) **30.** (1) (a) The operator of every aircraft to which Article 25 of this Order applies shall establish and include in the operations manual relating to the aircraft such particulars of aerodrome operating minima as are appropriate to every aerodrome of intended departure or landing and every alternate aerodrome:

Provided that in relation to any flight wherein it is not practicable to include such information in the operations manual the operator of the said aircraft shall, prior to the commencement of the flight, cause to be furnished, in writing, to the commander of the aircraft such particulars of the aerodrome operating minima as are appropriate to every aerodrome of intended departure or landing and every alternate aerodrome and calculated in accordance with the specified method; and the operator shall cause a copy of the said particulars to be retained outside the aircraft for a minimum period of three months.

- (b) The operator of every such aircraft shall include in the operations manual relating to that aircraft such data and instructions as will enable the commander of the aircraft to calculate such aerodrome operating minima as are appropriate to aerodromes the use of which could not reasonably have been foreseen by the operator prior to the commencement of the flight.
- (2) The aerodrome operating minima specified shall not, in respect of any aerodrome, be less favourable than any declared in respect of that aerodrome by the competent authority, unless that authority otherwise permits in writing.
- (3) In establishing aerodrome operating minima for the purposes of this Article the operator of the aircraft shall take into account the following matters—
- (a) the type and performance and handling characteristics of the aircraft and any relevant conditions in its certificate of airworthiness; and
 - (b) the composition of its crew; and
 - (c) the physical characteristics of the relevant aerodrome and its surroundings; and
 - (d) the dimensions of the runways which may be selected for use; and
 - (e) whether or not there are in use at the relevant aerodrome any aids, visual or otherwise to assist aircraft in approach, landing or take-off, being aids which the crew of the aircraft are trained and equipped to use; the nature of any such aids that are in use; and the procedures for approach, landing and take-off which may be adopted according to the existence or absence of such aids:
- and shall establish in relation to each runway which may be selected for use such aerodrome operating minima as are appropriate to each set of circumstances which can reasonably be expected.
- (4) An aircraft to which Article 25 of this Order applies shall not commence a flight at a time when—
- (a) the cloud ceiling or the runway visual range at the aerodrome of departure is less than the relevant minimum specified for take-off; or
 - (b) according to the information available to the commander of the aircraft it would not be able, without contravening paragraph (5) of this Article, to land at the aerodrome of intended destination at the estimated time of arrival there and at any alternate aerodrome at any time at which according to a reasonable estimate the aircraft would arrive there.
- (5) An aircraft to which Article 25 of this Order applies when making a descent to an aerodrome shall not:—
- (a) descend below 1,000 feet above the height of the aerodrome if the relevant runway visual range at the aerodrome is at the time less than the specified minimum for landing; or
 - (b) (i) continue an approach to landing at any aerodrome by flying below the relevant specified decision height, or
 - (ii) descend below the relevant specified minimum descent heightunless from that height the specified visual reference for landing is established and is maintained.
- (6) If, according to the information available, an aircraft would as regards any flight be required by the Rules of the Air and Air Traffic Control to be flown in accordance with the Instrument Flight Rules at the aerodrome of intended landing, the commander of the aircraft shall select prior to take-off an alternate aerodrome unless no aerodrome suitable for that purpose is available.
- (7) In this Article “specified” in relation to aerodrome operating minima means such particulars of aerodrome operating minima as have been specified by the operator in, or are ascertainable by reference to, the operations manual relating to that aircraft, or furnished in writing to the commander of the aircraft by the operator pursuant to the proviso to paragraph (1)(a) of this Article.

Aircraft not registered in Hong Kong— aerodrome operating minima

31.—(1) A public transport aircraft registered in a country other than Hong Kong shall not fly in or over Hong Kong unless the operator thereof shall have furnished to the Governor such particulars as he may from time to time have required relating to the aerodrome operating minima specified by the operator in relation to aerodromes in Hong Kong for the purpose of limiting their use by the aircraft for take-off or landing, including any instructions given by the operator in relation to such aerodrome operating minima. The aircraft shall not fly in or over Hong Kong unless the operator shall have made such amendments or additions to the aerodrome operating minima so specified and any instructions so given as the Governor may require for the purpose of ensuring the safety of the aircraft or the safety, efficiency or regularity of air navigation.

(2) The aircraft shall not take off or land at an aerodrome in Hong Kong in contravention of the specified aerodrome operating minima or the specified instruction.

(3) Without prejudice to the provisions of paragraph (2) of this Article, a public transport aircraft registered in a country other than Hong Kong when making a descent to an aerodrome shall not:—

- (a) descend below 1,000 feet above the height of the aerodrome if the relevant runway visual range at the aerodrome is at the time less than the specified minimum for landing; or
- (b) (i) continue an approach to landing at any aerodrome by flying below the relevant specified decision height, or
(ii) descend below the relevant specified minimum descent height
unless from that height the specified visual reference for landing is established and is maintained.

(4) In this Article “specified” in relation to an aircraft means specified by the operator in, or ascertainable by reference to, the particulars furnished by the operator to the Governor pursuant to paragraph (1) of this Article.

Non-public transport aircraft— aerodrome operating minima

31A.—(1) This Article shall apply to any aircraft which is not a public transport aircraft.

(2) An aircraft to which this Article applies when making a descent at an aerodrome to a runway in respect of which there is a notified instrument approach procedure shall not descend from a height of 1,000 feet or more above the aerodrome to a height of less than 1,000 feet above the aerodrome if the relevant runway visual range for that runway is at the time less than the specified minimum for landing.

(3) An aircraft to which this Article applies when making a descent to a runway in respect of which there is a notified instrument approach procedure shall not:

- (a) continue an approach to landing on such a runway by flying below the relevant specified decision height; or
- (b) descend below the relevant specified minimum descent height;

unless in either case the specified visual reference for landing is established from such height and is maintained.

(4) In this Article “specified” in relation to aerodrome operating minima means such particulars of aerodrome operating minima as have been notified in respect of the aerodrome or if the relevant minima have not been notified such minima as are ascertainable by reference to the notified method for calculating aerodrome operating minima.

Pre-flight action by commander of aircraft

32. The commander of an aircraft registered in Hong Kong shall satisfy himself before the aircraft takes off—

- (a) that the flight can safely be made, taking into account the latest information available as to the route and aerodromes to be used, the weather reports and forecasts available, and any alternative course of action which can be adopted in case the flight cannot be completed as planned;
- (b) that the equipment (including radio apparatus) required by or under this Order to be carried in the circumstances of the intended flight is carried and is in a fit condition for use;
- (c) that the aircraft is in every way fit for the intended flight, and that where a certificate of maintenance review is required by Article 9(1) of this Order to be in force, it is in force and will not cease to be in force during the intended flight;
- (d) that the load carried by the aircraft is of such weight, and is so distributed and secured that it may safely be carried on the intended flight;
- (e) in the case of a flying machine or airship, that sufficient fuel, oil and engine coolant (if required) are carried for the intended flight and that a safe margin has been allowed for contingencies and, in the case of a flight for the purpose of public transport, that the instructions in the operations manual relating to fuel, oil and engine coolant have been complied with;
- (f) in the case of an airship or balloon, that sufficient ballast is carried for the intended flight;
- (g) in the case of a flying machine, that, having regard to the performance of the flying machine in the conditions to be expected on the intended flight, and to any obstructions at the places of departure and intended destination and on the intended route, it is capable of safely taking off, reaching and maintaining a safe height thereafter, and making a safe landing at the place of intended destination;
- (h) that any pre-flight check system established by the operator and set forth in the operations manual or elsewhere has been complied with by each member of the crew of the aircraft.

Pilots to remain at controls

33.—(1) The commander of an aircraft registered in Hong Kong, being a flying machine or glider, shall cause one pilot to remain at the controls at all times while the aircraft is in flight. If the aircraft is required by or under this Order to carry two pilots, the commander shall cause both pilots to remain at the controls during take-off and landing. If the aircraft carries two or more pilots (whether or not it is required to do so) and is engaged on a flight for the purpose of the public transport of passengers the commander shall remain at the controls during take-off and landing.

(2) Each pilot at the controls shall be secured in his seat by either a safety belt with or without one diagonal shoulder strap, or a safety harness except that during take-off and landing a safety harness shall be worn if it is required by Article 13 of this Order to be provided.

Wearing of survival suits by crew

33A. Each member of the crew of an aircraft registered in Hong Kong shall wear a survival suit if such a suit is required by Article 13 of this Order to be carried.

Public transport of passengers—duties of commander

34.—(1) This Article applies to flights for the purpose of the public transport of passengers by aircraft registered in Hong Kong.

- (2) In relation to every flight to which this Article applies the commander of the aircraft shall—
- (a) before the aircraft takes off, take all reasonable steps to ensure that all passengers are made familiar with the position and method of use of emergency exits, safety belts, safety harnesses, and (where required to be carried) oxygen equipment, life jackets and the floor path lighting system and all other devices required by or under this Order and intended for use by passengers individually in case of an emergency occurring to the aircraft;
 - (b)
 - (i) if the aircraft is not a seaplane but is intended in the course of the flight to reach a point more than 30 minutes flying time (while flying in still air at the speed specified in the relevant certificate of airworthiness as the speed for compliance with regulations governing flights over water) from the nearest land, take all reasonable steps to ensure that before take-off, all passengers are given a demonstration of the method of use of the lifejackets required by or under this Order for the use of passengers.
 - (ii) if the aircraft is not a seaplane but is required by Article 18(7) of this Order to carry cabin attendants, take all reasonable steps to ensure that, before the aircraft takes-off on a flight:
 - (aa) which is intended to proceed beyond gliding distance from land, or
 - (bb) on which in the event of any emergency occurring during the take-off or during the landing at the intended destination or any likely alternate destination it is reasonably possible that the aircraft would be forced to land onto water;all passengers are given a demonstration of the method of use of the lifejackets required by or under this Order for the use of passengers:

Provided that where the only requirement to give such a demonstration arises because it is reasonably possible that the aircraft would be forced to land onto water at one or more of the likely alternate destinations the demonstration need not be given until after the decision has been taken to divert to such a destination.
 - (c) if the aircraft is a seaplane, take all reasonable steps to ensure that before the aircraft takes off all passengers are given a demonstration of the method of use of the equipment referred to in the preceding sub-paragraph;
 - (d) before the aircraft takes off, and before it lands, take all reasonable steps to ensure that the crew of the aircraft are properly secured in their seats and that any persons carried in compliance with Article 18(7) of this Order are properly secured in seats which shall be in a passenger compartment and which shall be so situated that those persons can readily assist passengers;
 - (e) before the aircraft takes-off, and before it lands, and whenever by reason of turbulent air or any emergency occurring during the flight he considers the precaution necessary:
 - (i) take all reasonable steps to ensure that all passengers of two years of age or more are properly secured in their seats by safety belts or safety harnesses and that all passengers under the age of two years are properly secured by means of a child restraint device; and
 - (ii) take all reasonable steps to ensure that those items of baggage in the passenger compartment which he reasonably considers ought by virtue of their size, weight or nature to be properly secured are properly secured and, in the case of an aircraft capable of seating more than 30 passengers, that such baggage is either stowed in the passenger compartment stowage spaces approved by the Governor for the purpose of stowing baggage or carried in accordance with the terms of a written permission

granted by the Governor which permission may be granted subject to such conditions as the Governor thinks fit.

- (f) in an emergency, take all reasonable steps to ensure that all passengers are instructed in the emergency action which they should take;
- (g) in the case of aircraft in respect of which a certificate of airworthiness was first issued (whether in Hong Kong or elsewhere) on or after 1st January 1989 except in a case where a pressure greater than 700 millibars is maintained in all passenger and crew compartments throughout the flight, take all reasonable steps to ensure that—
 - (i) before the aircraft reaches flight level 100 the method of use of the oxygen provided in the aircraft in compliance with the requirements of Article 13 of this Order is demonstrated to all passengers;
 - (ii) when flying above flight level 120 all passengers and cabin attendants are recommended to use oxygen; and
 - (iii) during any period when the aircraft is flying above flight level 100 oxygen is used by all the flight crew of the aircraft;
- (h) in the case of aircraft in respect of which a certificate of airworthiness was first issued (whether in Hong Kong or elsewhere) prior to 1st January 1991, except in the case where a pressure greater than 700 millibars is maintained in all passenger and crew compartments throughout the flight, take all reasonable steps to ensure that—
 - (i) before the aircraft reaches flight level 130 the method of use of the oxygen provided in the aircraft in compliance with the requirements of Article 13 of this Order is demonstrated to all passengers;
 - (ii) when flying above flight level 130 all passengers and cabin attendants are recommended to use oxygen; and
 - (iii) during any period when the aircraft is flying above flight level 100 oxygen is used by all the flight crew of the aircraft;

Provided that he need not comply with the provisions of this sub-paragraph (h) if he complies instead with the provisions of sub-paragraph (g) of this Article.

Operation of radio in aircraft

35.—(1) The radio station in an aircraft shall not be operated, whether or not the aircraft is in flight, except in accordance with the conditions of the licence issued in respect of that station under the law of the country in which the aircraft is registered, and by a person duly licensed or otherwise permitted to operate the radio station under that law.

(2) Whenever an aircraft is in flight in such circumstances that it is required by or under this Order to be equipped with radio communications apparatus, a continuous radio watch shall be maintained by a member of the flight crew listening to the signals transmitted upon the frequency notified, or designated by a message received from an appropriate aeronautical radio station, for use by the aircraft:

Provided that—

- (a) the radio watch may be discontinued or continued on another frequency to the extent that a message as aforesaid so permits; and
- (b) the watch may be kept by a device installed in the aircraft if—
 - (i) the appropriate aeronautical radio station has been informed to that effect and has raised no objection; and
 - (ii) that station is notified, or in the case of a station situated in a country other than Hong Kong, otherwise designated as transmitting a signal suitable for that purpose.

(3) Whenever an aircraft is in flight in such circumstances that it is required by or under this Order to be equipped with radio or radio navigation equipment a member of the flight crew shall operate that equipment in such a manner as he may be instructed by the appropriate air traffic control unit or as may be notified in relation to any notified airspace in which the aircraft is flying.

(4) The radio station in an aircraft shall not be operated so as to cause interference which impairs the efficiency of aeronautical telecommunications or navigational services, and in particular emissions shall not be made except as follows:

- (a) emissions of the class and frequency for the time being in use, in accordance with general international aeronautical practice, in the airspace in which the aircraft is flying;
- (b) distress, urgency and safety messages and signals, in accordance with general international aeronautical practice;
- (c) messages and signals relating to the flight of the aircraft, in accordance with general international aeronautical practice;
- (d) such public correspondence messages as may be permitted by or under the aircraft radio station licence referred to in paragraph (1) of this Article.

(5) In every aircraft registered in Hong Kong which is equipped with radio communication apparatus a telecommunication log book shall be kept in which the following entries shall be made:

- (a) the identification of the aircraft radio station;
- (b) the date and time of the beginning and end of every radio watch maintained in the aircraft and of the frequency on which it was maintained;
- (c) the date and time, and particulars of all messages and signals sent or received, including in particular details of any distress signals or distress messages sent or received;
- (d) particulars of any action taken upon the receipt of a distress signal or distress message;
- (e) particulars of any failure or interruption of radio communications and the cause thereof:

Provided that a telecommunication log book shall not be required to be kept in respect of communication by radiotelephony with a radio station on land or on a ship which provides a radio service for aircraft.

(6) The flight radio operator maintaining radio watch shall sign the entries in the telecommunication log book indicating the times at which he began and ended the maintenance of such watch.

(7) The telecommunication log book shall be preserved by the operator of the aircraft until a date 6 months after the date of the last entry therein.

(8) In any flying machine registered in Hong Kong which is engaged on a flight for the purpose of public transport the pilot and the flight engineer (if any) shall not make use of a hand-held microphone (whether for the purpose of radio communication or of intercommunication within the aircraft) whilst the aircraft is flying in controlled airspace below flight level 150 or is taking off or landing.

Minimum navigation performance

36. An aircraft registered in Hong Kong shall not fly in airspace prescribed for the purpose of this Article by Regulation 17 of Schedule 15 of this Order unless—

- (a) it is equipped with navigation systems which enable the aircraft to maintain the prescribed navigation performance capability; and
- (b) the navigation systems required by paragraph (a) hereof are approved by the Governor and installed and maintained in a manner approved by the Governor; and

- (c) the operating procedures for the navigation systems required by paragraph (a) hereof are approved by the Governor; and
- (d) the equipment is operated in accordance with the approved procedures while the aircraft is flying in the said airspace.

Use of flight recording systems and preservation of records

37.—(1) On any flight on which a flight data recorder or a cockpit voice recorder or a combined cockpit voice recorder/flight data recorder is required by sub-paragraph 4(4), (5), (6) or (7) of Schedule 5 to this Order to be carried in an aeroplane, it shall always be in use from the beginning of the take-off run to the end of the landing run.

(2) The operator of the aeroplane shall at all times, subject to the provisions of Article 61 of this Order, preserve:

- (a) the last 25 hours of recording made by any flight data recorder required by or under this Order to be carried in an aeroplane; and
- (b) a record of not less than one representative flight, that is to say, a recording of a flight made within the last 12 months which includes a take-off, climb, cruise, descent, approach to landing and landing, together with a means of identifying the record with the flight to which it relates;

and shall preserve such records for such period as the Governor may in a particular case direct.

(3) On any flight on which a cockpit voice recorder or a flight data recorder or a combined cockpit voice recorder/flight data recorder is required by paragraph 4(14) of Schedule 5 of this Order to be carried in a helicopter, it shall always be in use from the time the rotors first turn for the purpose of taking off until the rotors are next stopped.

(4) The operator of the helicopter shall at all times, subject to Article 61 of this Order, preserve:

- (a) the last 8 hours of recording made by any flight data recorder specified at sub-paragraph (i) or (ii) of Scale SS of paragraph 5 of Schedule 5 to this Order and required by or under this Order to be carried in the helicopter;
- (b) in the case of a combined cockpit voice recorder/flight data recorder specified at sub-paragraph (iii) of the said Scale SS and required by or under this Order to be carried in a helicopter either:
 - (i) the last eight hours of recording; or
 - (ii) the last five hours of recording or the duration of the last flight, whichever is the greater (together hereinafter referred to in this Article as the “required recording”), together with an additional period of recording for either:
 - (aa) the period immediately preceding the required recording; or
 - (bb) such period or periods as the Governor may permit in any particular case or class of cases generally.

(5) The additional recording retained pursuant to sub-paragraphs (b)(ii)(aa) and (bb) of paragraph (4) above shall, together with the required recording, total a period of eight hours and shall be retained in accordance with arrangements approved by the Governor.

(6) An approval granted by the Governor for the purposes of this Article shall be in writing and may be subject to such conditions as the Governor thinks fit.

Towing of gliders

38.—(1) An aircraft in flight shall not tow a glider unless the certificate of airworthiness issued or rendered valid in respect of the towing aircraft under the law of the country in which that aircraft is registered includes an express provision that it may be used for that purpose.

(2) The length of the combination of towing aircraft, tow rope and glider in flight shall not exceed 150 metres.

(3) The commander of an aircraft which is about to tow a glider shall satisfy himself, before the towing aircraft takes off—

- (a) that the tow rope is in good condition and is of adequate strength for the purpose, and that the combination of towing aircraft and glider, having regard to its performance in the conditions to be expected on the intended flight and to any obstructions at the place of departure and on the intended route, is capable of safely taking off, reaching and maintaining a safe height at which to separate the combination and that thereafter the towing aircraft can make a safe landing at the place of intended destination;
- (b) that signals have been agreed and communication established with persons suitably stationed so as to enable the glider to take off safely;
- (c) that emergency signals have been agreed between the commander of the towing aircraft and the commander of the glider, to be used, respectively, by the commander of the towing aircraft to indicate that the tow should immediately be released by the glider, and by the commander of the glider to indicate that the tow cannot be released.

(4) The glider shall be attached to the towing aircraft by means of the tow rope before the aircraft takes off.

Towing, picking up and raising of persons and articles

39.—(1) Subject to the provisions of this Article, an aircraft in flight shall not, by means external to the aircraft, tow any article, other than a glider, or pick up or raise any person, animal or article, unless the certificate of airworthiness issued or rendered valid in respect of that aircraft under the law of the country in which the aircraft is registered includes an express provision that it may be used for that purpose.

(2) An aircraft shall not launch or pick up tow ropes, banners or similar articles other than at an aerodrome.

(3) An aircraft in flight shall not tow any article, other than a glider, at night or when flight visibility is less than one nautical mile.

(4) The length of the combination of towing aircraft, tow rope, and article in tow, shall not exceed 150 metres.

(5) A helicopter shall not fly at any height over a congested area of a city, town or settlement at any time when any person, article or animal is suspended from the helicopter.

(6) A passenger shall not be carried in a helicopter at any time when an article, person or animal is suspended therefrom, other than a passenger who has duties to perform in connection with the article, person or animal or a passenger who has been picked up or raised by means external to the helicopter or a passenger who it is intended shall be lowered to the surface by such means.

(7) Nothing in this Article shall—

- (a) prohibit the towing in a reasonable manner by an aircraft in flight of any radio aerial, any instrument which is being used for experimental purposes, or any signal, apparatus or article required or permitted by or under this Order to be towed or displayed by an aircraft in flight;

- (b) prohibit the picking up or raising of any person, animal or article in an emergency or for the purpose of saving life;
- (c) apply to any aircraft while it is flying in accordance with the “B Conditions” set forth in Schedule 2 to this Order;
- (d) be taken to permit the towing or picking up of a glider otherwise than in accordance with Article 38 of this Order.

Dropping of animals and articles

40.—(1) Articles and animals (whether or not attached to a parachute) shall not be dropped, or permitted to drop, from an aircraft in flight so as to endanger persons or property.

(2) Except under and in accordance with the terms of an aerial application certificate granted under Article 42 of this Order articles and animals (whether or not attached to a parachute) shall not be dropped or permitted to drop, to the surface from an aircraft flying over Hong Kong:

Provided that this paragraph shall not apply to the dropping of articles by, or with the authority of, the commander of the aircraft in any of the following circumstances:

- (a) the dropping of articles for the purpose of saving life;
- (b) the jettisoning, in case of emergency, of fuel or other articles in the aircraft;
- (c) the dropping of ballast in the form of fine sand or water;
- (d) the dropping of articles solely for the purpose of navigating the aircraft in accordance with ordinary practice or with the provisions of this Order;
- (e) the dropping at an aerodrome of tow ropes, banners, or similar articles towed by aircraft;
- (f) the dropping of articles for the purposes of public health or as a measure against weather conditions, surface icing or oil pollution, or for training for the dropping of articles for any such purposes, if the articles are dropped with the permission of the Governor and in accordance with any conditions subject to which that permission may have been given;
- (g) the dropping of wind drift indicators for the purpose of enabling parachute descents to be made if the wind drift indicators are dropped with the permission of the Governor and in accordance with any conditions subject to which that permission may have been given.

(3) For the purposes of this Article dropping includes projecting and lowering.

(4) Nothing in this Article shall prohibit the lowering of any animal or article from a helicopter to the surface, if the certificate of airworthiness issued or rendered valid in respect of the helicopter under the law of the country in which it is registered includes an express provision that it may be used for that purpose.

Dropping of persons

41.—(1) A person shall not drop, be dropped or permitted to drop to the surface or jump from an aircraft flying over Hong Kong except under and in accordance with the terms of a written permission granted by the Governor under this Article.

(2) For the purpose of this Article dropping includes projecting and lowering.

(3) Notwithstanding the grant of a permission under paragraph (1) of this Article, a person shall not drop, be dropped or be permitted to drop from an aircraft in flight so as to endanger persons or property.

(4) An aircraft shall not be used for the purpose of dropping persons unless the certificate of airworthiness issued or rendered valid in respect of that aircraft under the law of the country in which the aircraft is registered includes an express provision that it may be used for that purpose and the

aircraft is operated in accordance with the written permission granted by the Governor under this Article.

(5) Every applicant for and every holder of a permission shall make available to the Governor if requested to do so a parachuting manual and shall make such amendments or additions to such manual as the Governor may require. The holder of a permission shall make available to every employee or person who is engaged or may engage in parachuting activities conducted by him the manual which shall contain all such information and instructions as may be necessary to enable such employees or persons to perform their duties.

(6) Nothing in this Article shall apply to the descent of persons by parachute from an aircraft in an emergency.

(7) Nothing in this Article shall prohibit the lowering of any person in an emergency or for the purpose of saving life.

(8) Nothing in this Article shall prohibit the lowering of any person from a helicopter to the surface, if the certificate of airworthiness issued or rendered valid in respect of the helicopter under the law of the country in which it is registered includes an express provision that it may be used for that purpose.

Issue of aerial application certificates

42.—(1) An aircraft shall not be used for the dropping of articles for the purposes of agriculture, horticulture or forestry or for training for the dropping of articles for any of such purposes, otherwise than under and in accordance with the terms of an aerial application certificate granted to the operator of the aircraft under paragraph (2) of this Article.

(2) The Governor may grant to any person applying therefor an aerial application certificate if he is satisfied that that person is a fit person to hold the certificate and is competent, having regard in particular to his previous conduct and experience, his equipment, organisation, staffing and other arrangements, to secure the safe operation of the aircraft specified in the certificate on flights for the purposes specified in paragraph (1) of this Article. The certificate may be granted subject to such conditions as the Governor thinks fit including, without prejudice to the generality of the foregoing, conditions for ensuring that the aircraft and any article dropped from it do not endanger persons or property in the aircraft or elsewhere, and shall, subject to the provisions of Article 62 of this Order, remain in force for the period specified in the certificate.

(3) Every applicant for and the holder of an aerial application certificate shall make available to the Governor upon application and to every member of his operating staff upon the certificate being granted an aerial application manual which shall contain all such information and instructions as may be necessary to enable the operating staff to perform their duties as such. The holder of a certificate shall make such amendments of or additions to the manual as the Governor may require.

(4) For the purposes of this Article “operating staff” has the meaning ascribed to it in Article 25(4) of this Order.

Carriage of weapons and of munitions of war

43.—(1) An aircraft shall not carry any munition of war unless:

- (a) such munition of war is carried with the written permission of the Governor and in accordance with any conditions relating thereto; and
- (b) the commander or the aircraft is informed in writing by the operator before the flight commences of the type, weight or quantity and location of any such munition of war on board or suspended beneath the aircraft and any conditions of the permission of the Governor.

(2) Notwithstanding paragraph (1) of this Article it shall be unlawful for an aircraft to carry any weapon or munition of war in any compartment or apparatus to which passengers have access.

(3) It shall be unlawful for a person to carry or have in his possession or take or cause to be taken on board an aircraft, to suspend or cause to be suspended beneath an aircraft or to deliver or cause to be delivered for carriage thereon any weapon or munition of war unless—

- (a) the weapon or munition of war:
 - (i) is either part of the baggage of a passenger on the aircraft or consigned as cargo to be carried thereby;
 - (ii) is carried in a part of the aircraft, or in any apparatus attached to the aircraft inaccessible to passengers; and
 - (iii) in case of a firearm, is unloaded;
- (b) particulars of the weapon or munition of war have been furnished by that passenger or by the consignor to the operator before the flight commences; and
- (c) without prejudice to paragraph (1) of this Article the operator consents to the carriage of such weapon or munition of war by the aircraft.

(4) Nothing in this Article shall apply to any weapon or munition of war taken or carried on board an aircraft registered in a country other than Hong Kong, if the weapon or munition of war, as the case may be, may under the law of the country in which the aircraft is registered be lawfully taken or carried on board for the purpose of ensuring the safety of the aircraft or of persons on board.

(5) For the purposes of this Article a “munition of war” means any weapon, ammunition or article containing an explosive or any noxious liquid, gas or other thing which is designed or made for use in warfare or against persons, including parts, whether components or accessories, for such weapon, ammunition or article.

Carriage of dangerous goods

44.—(1) It shall be an offence to contravene or permit the contravention of or fail to comply with any of the regulations set out in Schedule 16 to this Order:

Provided that the Governor may make regulations which supplement, amend or replace the regulations set out in the said Schedule 16, and which prescribe—

- (a) the classification of certain articles and substances as dangerous goods;
- (b) the categories of dangerous goods which an aircraft may not carry;
- (c) the conditions which apply to the loading on, suspension beneath and carriage by an aircraft of dangerous goods;
- (d) the manner in which dangerous goods must be packed, marked, labelled and consigned before being loaded on, suspended beneath or carried by an aircraft;
- (e) any other provisions for securing the safety of aircraft and any apparatus attached thereto, and the safety of persons and property on the surface in relation to the loading on, suspension beneath or carriage by an aircraft of dangerous goods;
- (f) the persons to whom information about the carriage of dangerous goods must be provided;
- (g) the documents relating to the carriage by an aircraft of dangerous goods which must be produced to the Governor or an authorised person on request.

(2) The provisions of paragraph (1) of this Article shall be without prejudice to any other provisions of this Order; and the provisions of paragraph (1) of this Article, of Schedule 16 to this Order and of any regulations supplementing, amending or replacing the regulations set out in the

said Schedule 16 shall be additional to and not in derogation from the provisions of Article 43 of this Order.

Method of carriage of persons

45. A person shall not be in or on any part of an aircraft in flight which is not a part designed for the accommodation of persons and in particular a person shall not be on the wings or undercarriage of an aircraft. A person shall not be in or on any object, other than a glider or flying machine, towed by or attached to an aircraft in flight:

Provided that a person may have temporary access to—

- (a) any part of an aircraft for the purpose of taking action necessary for the safety of the aircraft or of any person, animal or goods therein;
- (b) any part of an aircraft in which cargo or stores are carried, being a part which is designed to enable a person to have access thereto while the aircraft is in flight.

Exits and break-in markings

46.—(1) This Article shall apply to every public transport aircraft registered in Hong Kong.

(2) Whenever an aircraft to which this Article applies is carrying passengers, every exit therefrom and every internal door in the aircraft shall be in working order, and during take-off and landing and during any emergency, every such exit and door shall be kept free of obstruction and shall not be fastened by locking or otherwise so as to prevent, hinder or delay its use by passengers:

Provided that—

- (a) an exit may be obstructed by cargo if it is an exit which, in accordance with arrangements approved by the Governor either generally or in relation to a class of aircraft or a particular aircraft, is not required for use by passengers;
- (b) a door between the flight crew compartment and any adjacent compartment to which passengers have access may be locked or bolted if the commander of the aircraft so determines, for the purpose of preventing access by passengers to the flight crew compartment; and
- (c) nothing in this paragraph shall apply to any internal door which is so placed that it cannot prevent, hinder or delay the exit of passengers from the aircraft in an emergency if it is not in working order.

(3) Every exit from the aircraft shall be marked with the words “Exit” or “Emergency Exit” in capital letters.

- (a) (4) (a) Every exit from the aircraft shall be marked with instructions in English and with diagrams, to indicate the correct method of opening the exit;
- (b) The markings shall be placed on or near the inside surface of the door or other closure of the exit and, if it is openable from the outside of the aircraft, on or near the exterior surface.
- (a) (5) (a) Every aircraft to which this Article applies, being an aircraft of which the maximum total weight authorised exceeds 3,600 kg, shall be marked upon the exterior surface of its fuselage with markings to show the areas (in this paragraph referred to as “break-in areas”) which can, for purposes of rescue in an emergency, be most readily and effectively broken into by persons outside the aircraft.
- (b) The break-in areas shall be rectangular in shape and shall be marked by right-angled corner markings, each arm of which shall be 10 centimetres in length along its outer edge and 2.5 centimetres in width.

- (c) The words “Cut Here in Emergency” shall be marked across the centre of each break-in area in capital letters:

Provided that this paragraph shall not apply to helicopters.

(6) On every flight by an aircraft to which this Article applies, being an aircraft of which the maximum total weight authorised exceeds 5,700 kg, every exit from such an aircraft intended to be used by passengers in an emergency shall be marked upon the exterior of the aircraft by a band not less than 5 centimetres in width outlining the exit.

(7) The markings required by this Article shall—

- (a) be painted, or affixed by other equally permanent means;
- (b) except in the case of the markings required by paragraph (6) of this Article, be red in colour, and in any case in which the colour of the adjacent background is such as to render red markings not readily visible, be outlined in white or some other contrasting colour in such a manner as to render them readily visible;
- (c) in the case of the markings required by paragraph (6) of this Article, be of a colour clearly contrasting with the background on which it appears; and
- (d) be kept at all times clean and unobscured.

(8) If one, but not more than one, exit from an aircraft becomes inoperative at a place where it is not reasonably practicable for it to be repaired or replaced, nothing in this Article shall prevent that aircraft from carrying passengers until it next lands at a place where the exit can be repaired or replaced:

Provided that—

- (a) the number of passengers carried and the position of the seats which they occupy is in accordance with arrangements approved by the Governor either in relation to the particular aircraft or to a class of aircraft; and
- (b) in accordance with arrangements so approved, the exit is fastened by locking or otherwise, the words “Exit” or “Emergency Exit” are covered, and the exit is marked by a red disc at least 23 centimetres in diameter with a horizontal white bar across it bearing the words “No exit” in red letters.

Imperilling safety of aircraft

47. A person shall not recklessly or negligently act in a manner likely to endanger an aircraft, or any person therein.

Imperilling safety of any person or property

48. A person shall not recklessly or negligently cause or permit an aircraft to endanger any person or property.

Drunkenness in aircraft

49.—(1) A person shall not enter any aircraft when drunk, or be drunk in any aircraft.

(2) A person shall not, when acting as a member of the crew of any aircraft or being carried in any aircraft for the purpose of so acting, be under the influence of drink or a drug to such an extent as to impair his capacity so to act.

Smoking in aircraft

50.—(1) Notices indicating when smoking is prohibited shall be exhibited in every aircraft registered in Hong Kong so as to be visible from each passenger seat therein.

(2) A person shall not smoke in any compartment of an aircraft registered in Hong Kong at a time when smoking is prohibited in that compartment by a notice to that effect exhibited by or on behalf of the commander of the aircraft.

Authority of commander of aircraft

51. Every person in an aircraft registered in Hong Kong shall obey all lawful commands which the commander of that aircraft may give for the purpose of securing the safety of the aircraft and of persons or property carried therein, or the safety, efficiency or regularity of air navigation.

Stowaways

52. A person shall not secrete himself for the purpose of being carried in an aircraft without the consent of either the operator or the commander thereof or of any other person entitled to give consent to his being carried in the aircraft.

PART VI

FATIGUE OF CREW

Application and interpretation of Part VI

53.—(1) Articles 54 and 55 of this Order apply in relation to any aircraft registered in Hong Kong which is either:—

- (a) engaged on a flight for the purpose of public transport, or
- (b) operated by an air transport undertaking:

Provided that the said Articles shall not apply in relation to a flight made only for the purpose of instruction in flying given by or on behalf of a flying club or flying school, or a person who is not an air transport undertaking.

(2) In this Part of this Order, the following expressions shall, except where the context otherwise requires, have the meanings hereby respectively assigned to them, that is to say—

- (a) “flight time”, in relation to any person, means all time spent by that person in an aircraft whether or not registered in Hong Kong (other than an aircraft of which the maximum total weight authorised does not exceed 1,600 kg and which is not flying for the purpose of public transport or aerial work) while it is in flight and he is carried therein as a member of the crew thereof;
- (b) “day” means a continuous period of 24 hours beginning at midnight Greenwich Mean Time.

(3) For the purposes of this Part of the Order, a helicopter shall be deemed to be in flight from the moment the helicopter first moves under its own power for the purpose of taking off until the rotors are next stopped.

Fatigue of crew—operator’s responsibilities

54.—(1) The operator of an aircraft to which this Article applies shall not cause or permit that aircraft to make a flight unless:

- (a) he has established a scheme for the regulation of flight times for every person flying in that aircraft as a member of its crew; and
- (b) the scheme is approved by the Governor subject to such conditions as he thinks fit; and
- (c) either—
 - (i) the scheme is incorporated in the operations manual required by Article 25 of this Order, or
 - (ii) in a case where an operations manual is not required by that Article the scheme is incorporated in a document, a copy of which has been made available to every person flying in that aircraft as a member of its crew; and
- (d) he has taken all such steps as are reasonably practicable to ensure that the provisions of the scheme will be complied with in relation to every person flying in that aircraft as a member of its crew.

(2) The operator of an aircraft to which this Article applies shall not cause or permit any person to fly therein as a member of its crew if he knows or has reason to believe that that person is suffering from, or, having regard to the circumstances of the flight to be undertaken, is likely to suffer from, such fatigue while he is so flying as may endanger the safety of the aircraft or of its occupants.

(3) The operator of an aircraft to which this Article applies shall not cause or permit any person to fly therein as a member of its flight crew unless the operator has in his possession an accurate and up-to-date record in respect of that person and in respect of the 28 days immediately preceding the flight showing—

- (a) all his flight times; and
- (b) brief particulars of the nature of the functions performed by him in the course of his flight times.

(4) The record referred to in paragraph (3) of this Article shall, subject to the provisions of Article 61, be preserved by the operator of the aircraft until a date 12 months after the flight referred to in that paragraph.

Fatigue of crew—responsibilities of crew

55.—(1) A person shall not act as a member of the crew of an aircraft to which this Article applies if he knows or suspects that he is suffering from, or, having regard to the circumstances of the flight to be undertaken, is likely to suffer from, such fatigue as may endanger the safety of the aircraft or of its occupants.

(2) A person shall not act as a member of the flight crew of an aircraft to which this Article applies unless he has ensured that the operator of the aircraft is aware of his flight times during the period of 28 days preceding the flight.

Flight times—responsibilities of flight crew

56. A person shall not act as a member of the flight crew of an aircraft registered in Hong Kong if at the beginning of the flight the aggregate of all his previous flight times:—

- (a) during the period of 28 consecutive days expiring at the end of the day on which the flight begins exceeds 100 hours; or
- (b) during the period of 12 months expiring at the end of the previous month exceeds 900 hours.

Provided that this Article shall not apply to a flight made—

- (i) in an aircraft of which the maximum total weight authorised does not exceed 1,600 kg and which is not flying for the purposes of public transport or aerial work; or
- (ii) in an aircraft not flying for the purpose of public transport nor operated by an air transport undertaking, if at the time when the flight begins the aggregate of all the flight times of the aforesaid person since he was last medically examined and found fit by a person approved by the Governor for the purpose of Article 20(7) does not exceed 25 hours.

PART VII

DOCUMENTS AND RECORDS

Documents to be carried

57.—(1) An aircraft shall not fly unless it carries the documents which it is required to carry under the law of the country in which it is registered.

(2) An aircraft registered in Hong Kong shall, when in flight, carry documents in accordance with Schedule 12 to this Order:

Provided that, if the flight is intended to begin and end at the same aerodrome and does not include passage over the territory of any country other than Hong Kong, the documents may be kept at that aerodrome instead of being carried in the aircraft.

Records to be kept

58. The operator of a public transport aircraft registered in Hong Kong shall, in respect of any flight by that aircraft during which it may fly at an altitude of more than 49,000 feet, keep a record in a manner prescribed of the total dose of cosmic radiation to which the aircraft is exposed during the flight together with the names of the members of the crew of the aircraft during the flight.

Production of documents and records

59.—(1) The commander of an aircraft shall, within a reasonable time after being requested to do so by an authorised person, cause to be produced to that person—

- (a) the certificates of registration and airworthiness in force in respect of the aircraft;
- (b) the licences of its flight crew;
- (c) such other documents as the aircraft is required by Article 57 of this Order to carry when in flight.

(2) The operator of an aircraft registered in Hong Kong shall, within a reasonable time after being requested to do so by an authorised person, cause to be produced to that person such of the following documents or records as may have been requested by that person being documents or records which are required, by or under this Order, to be in force or to be carried, preserved or made available:

- (a) the documents referred to in Schedule 12 to this Order as Documents A, B and G;
- (b) the aircraft log book, engine log books and variable pitch propeller log books required under this Order to be kept;
- (c) the weight schedule, if any, required to be preserved under Article 16 of this Order;
- (d) in the case of a public transport aircraft or aerial work aircraft, the documents referred to in Schedule 12 to this Order as Documents D, E, F and H;

- (e) any records of flight times, duty periods and rest periods which he is required by Article 54(4) of this Order to preserve, and such other documents and information in the possession or control of the operator, as the authorised person may require for the purpose of determining whether those records are complete and accurate;
 - (f) any such operations manuals as are required to be made available under Article 25(2)(a)(i) of this Order;
 - (g) the record made by any flight data recorder required to be carried by or under this Order;
 - (h) the record made from any cosmic radiation detection equipment together with the record of the names of the members of the crew of the aircraft which are required to be kept under Article 58 of this Order.
- (a) (3) (a) The holder of a licence granted or rendered valid under this Order shall, within a reasonable time after being requested to do so by an authorised person, cause to be produced to that person his licence, including any certificate of validation. The requirements of this paragraph shall be deemed to have been complied with, except in relation to licences required by Article 57 of this Order to be carried in the aircraft or kept at an aerodrome, if the licence requested is produced within five days after the request has been made at a police station in Hong Kong specified, at the time of the request, by the person to whom the request is made.
- (b) The foregoing provisions of this paragraph shall apply to a medical certificate issued pursuant to Article 19(1)(b)(ii) as they apply to a licence granted or rendered valid under this Order.
- (4) Every person required by Article 22 of this Order to keep a personal flying log book shall cause it to be produced within a reasonable time to an authorised person after being requested to do so by him within two years after the date of the last entry therein.

Power to inspect and copy documents and records

60. An authorised person shall have the power to inspect and copy any certificate, licence, log book, document or record which he has the power pursuant to this Order and any regulations made thereunder to require to be produced to him.

Preservation of documents, etc.

61. A person required by this Order to preserve any document or record by reason of his being the operator of an aircraft shall, if he ceases to be the operator of the aircraft, continue to preserve the document or record as if he had not ceased to be the operator, and in the event of his death the duty to preserve the document or record shall fall upon his personal representative:

Provided that if—

- (a) another person becomes the operator of the aircraft he or his personal representative shall deliver to that person upon demand the certificates of maintenance review and release to service, the log books and the weight schedule and any record made by a flight data recorder and preserved in accordance with Article 37(2) of this Order which are in force or required to be preserved in respect of that aircraft;
- (b) an engine or variable pitch propeller is removed from the aircraft and installed in another aircraft operated by another person he or his personal representative shall deliver to that person upon demand the log book relating to that engine or propeller; or
- (c) any person in respect of whom a record has been kept by him in accordance with Article 54(4) of this Order becomes a member of the flight crew of a public transport aircraft registered in Hong Kong and operated by another person he or his personal representative shall deliver those records to that other person upon demand,

and it shall be the duty of that other person to deal with the document or record delivered to him as if he were the first-mentioned operator.

Revocation, suspension and variation of certificates, licences and other documents

62.—(1) Subject to paragraph (4) of this Article, the Governor may, if he thinks fit, provisionally suspend or vary any certificate, licence, approval, permission, exemption, authorisation or other document issued, granted or having effect under this Order, pending inquiry into or consideration of the case. The Governor may, on sufficient ground being shown to his satisfaction after due inquiry, revoke, suspend or vary any such certificate, licence approval, permission, exemption, authorisation or other document.

(2) The holder or any person having the possession or custody of any certificate, licence, approval, permission, exemption or other document which has been revoked, suspended or varied under this Order shall surrender it to the Governor within a reasonable time after being required to do so by him.

(3) The breach of any condition subject to which any certificate, licence, approval, permission, exemption or other document, other than a licence issued in respect of an aerodrome, has been granted or issued, or which has effect under this Order shall, in the absence of provision to the contrary in the document, render the document invalid during the continuance of the breach.

(4) Notwithstanding paragraph (1) of this Article, a flight manual, performance schedule or other document incorporated by reference in the certificate of airworthiness may be varied on sufficient ground being shown to the satisfaction of the Governor, whether or not after due inquiry.

Offences in relation to documents and records

63.—(1) A person shall not with intent to deceive—

- (a) use any certificate, licence, approval, permission, exemption or other document issued or required by or under this Order which has been forged, altered, revoked or suspended, or to which he is not entitled; or
- (b) lend any certificate, licence, approval, permission, exemption or other document issued or having effect or required by or under this Order to, or allow it to be used by, any other person; or
- (c) make any false representation for the purpose of procuring for himself or any other person the grant, issue, renewal or variation of any such certificate, licence, approval, permission, exemption or other document,

and in this paragraph a reference to a certificate, licence, approval, permission, exemption or other document includes a copy or purported copy thereof.

(2) A person shall not intentionally damage, alter or render illegible any log book or other record required by or under this Order to be maintained or any entry made therein, or knowingly make, or procure or assist in the making of, any false entry in or material omission from any such log book or record or destroy any such log book or record during the period from which it is required under this Order to be preserved.

(3) All entries made in writing in any log book or record referred to in paragraph (2) of this Article shall be made in ink or indelible pencil.

(4) A person shall not knowingly make in a load sheet any entry which is incorrect in any material particular, or any material omission from such a load sheet.

(5) A person shall not purport to issue any certificate for the purposes of this Order or the regulations made thereunder unless he is authorised to do so under this Order.

(6) A person shall not issue any such certificate as aforesaid unless he has satisfied himself that all statements in the certificate are correct.

PART VIII

CONTROL OF AIR TRAFFIC

Rules of the air

64.—(1) The Governor may make rules of the air supplementary to, but not inconsistent with, the Rules of the Air contained in Schedule 14 to this Order.

(2) Subject to the provisions of paragraph (3) of this Article, it shall be an offence to contravene, to permit the contravention of, or to fail to comply with, the Rules of the Air contained in Schedule 14 to this Order.

(3) It shall be lawful for the Rules of the Air to be departed from to the extent necessary—

- (a) for avoiding immediate danger; or
- (b) for complying with the law of any country other than Hong Kong within which the aircraft then is; or
- (c) for complying with Military Flying Regulations (Joint Service Publication 318) or Flying Orders to Contractors (Aviation Publication 67) issued by the Secretary of State in relation to an aircraft of which the commander is acting as such in the course of his duty as a member of Her Majesty's naval, military or air forces.

(4) If any departure from the Rules of the Air is made for the purpose of avoiding immediate danger, the commander of the aircraft shall cause written particulars of the departure, and of the circumstances giving rise to it, to be given within 10 days thereafter to the competent authority of the country in whose territory the departure was made or if the departure was made over the high seas, to the Governor.

(5) Nothing in the Rules of the Air shall exonerate any person from the consequences of any neglect in the use of lights or signals or of the neglect of any precautions required by ordinary aviation practice or by the special circumstances of the case.

Provision of air traffic services

64A.—(1) No person shall provide an air traffic service otherwise than under and in accordance with the terms of an approval granted to him by the Governor, and the Governor shall grant an approval to any person applying therefor if he is satisfied that the person is competent, having regard to his organisation, staffing, equipment, maintenance and other arrangements, to provide a service which is safe for use by aircraft.

(2) The person in charge of an aerodrome (other than a Government aerodrome) in respect of which there is equipment for providing holding aid, let-down aid or approach aid by radio or radar shall:

- (a) inform the Governor in advance of periods during and times at which any such equipment is to be in operation for the purpose of providing such aid as is specified by the said person; and
- (b) during any period and at such times as so notified, cause an air traffic control service to be provided for any aircraft which is flying in, or in the vicinity of, the aerodrome traffic zone whether or not it is flying by visual reference to the surface.

(3) The Governor may direct that there shall be provided in respect of any aerodrome (other than a Government aerodrome) such air traffic control service, aerodrome flight information service or means of two-way radio communication as the Governor considers appropriate in respect thereof. The Governor may specify in his direction the periods during and the times at which such a service

or such means shall be provided and the person in charge of the aerodrome shall cause such a service or such means to be provided in accordance with any such direction.

(4) Obligations to cause an air traffic control service to be provided arising under paragraphs (2) or (3) are without prejudice to each other.

Use of radio call signs at aerodromes

64B. The person in charge of an aerodrome provided with means of two-way radio communication shall not cause or permit any call sign to be used for a purpose other than a purpose for which that call sign has been notified.

Licensing of air traffic controllers, student air traffic controllers and aerodrome flight information service officers

65.—(1) The Governor may grant a licence subject to such conditions as he thinks fit to any person to act as an air traffic controller, as a student air traffic controller or as an aerodrome flight information service officer upon his being satisfied that the applicant is a fit person to hold the licence and is qualified by reason of his knowledge, experience, competence, skill, physical and mental fitness so to act, and for that purpose the applicant shall furnish such evidence and undergo such examinations and tests (including in particular medical examinations) as the Governor may require of him:

Provided that the Governor shall not grant—

- (a) a student air traffic controller's licence or an aerodrome flight information service officer's licence to a person under the age of 18 years; or
- (b) an air traffic controller's licence which includes an Aerodrome Control Rating, an Approach Control Rating or an Area Control Rating, to a person under the age of 20 years; or
- (c) an air traffic controller's licence which includes any other rating, to a person under the age of 21 years.

(2) Every licence to act as an air traffic controller shall include (a) ratings of one or more of the classes set forth in Schedule 10 to this Order specifying the type of air traffic control service which the holder of the licence is competent to provide, (b) a list of the places at which, and (c) the type of radar equipment, if any, with the aid of which he may provide the service. If throughout any period of 90 days the holder of the licence has not at any time provided at a particular place the type of air traffic control service specified in the rating, the rating shall, without prejudice to the Governor's powers under Article 62 of this order, cease to be valid for that place at the end of that period, and upon a rating ceasing to be valid for a place the holder of the licence shall forthwith inform the Governor to that effect and shall forward the licence to the Governor to enable it to be endorsed accordingly.

(3) Every licence to act as a student air traffic controller shall be valid only for the purpose of authorising the holder to provide air traffic control service under the supervision of another person who is present at the time and is the holder of a valid air traffic controller's licence which includes a rating specifying the type of air traffic control service which is being provided by the student air traffic controller and valid at the place in question.

(4) Every licence to act as an aerodrome flight information service officer shall be valid only for the purpose of authorising the holder to provide an aerodrome flight information service at an aerodrome specified in the licence. If, throughout any period of 180 days, the holder of the licence has not at any time provided such a service at a particular aerodrome, the licence shall cease to be valid for that aerodrome at the end of that period.

(5) A licence to act as an air traffic controller, as a student air traffic controller or as an aerodrome flight information service officer shall not be valid unless the holder of the licence has signed his name thereon in ink with his ordinary signature.

(6) Subject to the provisions of Article 62 of this Order, a licence to act as an air traffic controller, as a student air traffic controller or as an aerodrome flight information service officer shall remain in force for the period indicated in the licence and may be renewed by the Governor from time to time, upon his being satisfied that the applicant is a fit person and is qualified as aforesaid. If no period is indicated in the licence, it shall remain in force, subject as aforesaid, for the lifetime of the holder.

(7) Every applicant for and holder of an air traffic controller's licence or a student air traffic controller's licence shall upon such occasions as the Governor may require—

- (a) submit himself to medical examination by a person approved by the Governor either generally or in a particular case who shall make a report to the Governor in such form as the Governor may require; and
- (b) submit himself to such examinations and tests and furnish such evidence as to his knowledge, experience, competence and skill, as the Governor may require, and such examinations and tests may be conducted by the Governor or by a person approved by the Governor.

(8) Every applicant for and holder of an aerodrome flight information service officer's licence shall, upon such occasions as the Governor may require, subject himself to such examinations and tests and furnish such evidence as to his knowledge, experience, competence and skill as the Governor may require, and such examinations and tests may be conducted by the Governor or by a person approved by the Governor.

(9) On the basis of the medical examination referred to in paragraph (7) of this Article, the Governor or any person approved by him as competent to do so may issue a medical certificate subject to such conditions as he thinks fit to the effect that the holder of the licence has been assessed as fit to perform the functions to which the licence relates. The certificate shall, without prejudice to Article 68 of this Order, be valid for such period as is therein specified, and shall be deemed to form part of the licence.

(10) The holder of an air traffic controller's licence or student air traffic controller's licence shall not provide any type of air traffic control service at any such aerodrome or place as is referred to in article 66(1) of this Order unless his licence includes a medical certificate issued and in force under paragraph (9) of this Article.

Prohibition of unlicensed air traffic controllers, student air traffic controllers and aerodrome flight information service officers

66.—(1) A person shall not provide at any place any type of air traffic control service or an aerodrome flight information service or hold himself out, whether by use of a radio call sign or in any other way, as a person who may provide any type of air traffic control service or an aerodrome flight information service unless:

- (a) in the case of an air traffic control service, he is the holder, and complies with the terms of:
 - (i) a valid student air traffic controller's licence granted under this Order and he is supervised in accordance with Article 65(3) of this Order; or
 - (ii) a valid air traffic controller's licence so granted authorising him to provide that type of service at that place; or
 - (iii) a valid air traffic controller's licence so granted which does not authorise him to provide that type of service at that place, but he is supervised by a person who is present at the time and who is the holder of a valid air traffic controller's licence so

granted which authorises him to provide at that place the type of air traffic control service which is being provided; or

- (b) in the case of an aerodrome flight information service, he is the holder and complies with the terms of an aerodrome flight information service officer's licence granted under this Order authorising him to provide such a service at that place:

Provided that a licence shall not be required by any person who acts in the course of his duty as a member of any of Her Majesty's naval, military or air forces or a visiting force.

(2) The holder of an air traffic controller's licence shall not be entitled to perform any of the functions specified in Schedule 10 to this Order in respect of a rating at any place unless:

- (a) his licence includes that rating and the rating is valid for the place at which, and the type of radar equipment, if any, with the aid of which, the functions are performed; or
- (b) he is supervised by a person who is present at the time and who is the holder of a valid air traffic controller's licence granted under this Order which authorises him to provide at that place the type of air traffic control service which is being provided.

(3) A person shall not provide any type of air traffic control service or an aerodrome flight information service unless he identifies himself in such a manner as may be notified.

(4) Nothing in a licence granted under Article 65 of this Order shall permit any person to operate manually any direction-finding equipment for the purpose of providing air traffic control service to an aircraft at a time when he is providing air traffic control service or making signals to that aircraft or to another aircraft.

(5) Nothing in this Article shall prohibit the holder of a valid air traffic controller's licence from providing at any place for which the licence includes a valid rating, information to aircraft in flight in the interests of safety.

Flight Information Service Manual

67. A person shall not provide an aerodrome flight information service at any aerodrome unless:

- (a) the service is provided in accordance with the standards and procedures specified in an aerodrome flight information service manual in respect of that aerodrome;
- (b) the manual is produced to the Governor within a reasonable time after a request for its production is made by the Governor;
- (c) such amendments or additions as the Governor may from time to time require have been made to the manual.

Incapacity of air traffic controllers

68.—(1) Every holder of an air traffic controller's licence granted under Article 65 of this Order who—

- (a) suffers any personal injury or illness involving incapacity to undertake the functions to which his licence relates throughout a period of 20 consecutive days; or
- (b) in the case of a woman, who has reason to believe that she is pregnant;

shall inform the Governor in writing of such injury, illness or pregnancy as soon as possible.

(2) An air traffic controller's licence shall be deemed to be suspended upon the elapse of such period of injury or illness as is referred to in paragraph (1)(a) of this Article. The suspension of the licence shall cease:

- (a) upon the holder being medically examined under arrangements made by the Governor and pronounced fit to resume his functions under the licence; or

(b) upon the Governor exempting the holder from the requirement of a medical examination subject to such condition as the Governor may think fit.

(3) Upon the pregnancy of the holder of an air traffic controller's licence being confirmed, the licence shall be deemed to be suspended and such suspension may be lifted by the Governor subject to such conditions as he thinks fit, and shall cease upon the holder being medically examined under arrangements made by the Governor after the pregnancy has ended and pronounced fit to resume her functions under the licence.

Power to prohibit or restrict flying

(a) **69.** (1) (a) Where the Governor deems it necessary in the public interest to restrict or prohibit flying by reason of—

- (i) the intended gathering or movement of a large number of persons, or
- (ii) the intended holding of an aircraft race or contest or of an exhibition of flying, or
- (iii) national defence or any other reason affecting the public interest,

the Governor may make regulations prohibiting, restricting or imposing conditions on flight—

- (aa) by any aircraft, whether or not registered in Hong Kong, in any airspace over Hong Kong;
- (bb) by aircraft registered in Hong Kong, in any other airspace, being airspace in respect of which the Government of Hong Kong has in pursuance of international arrangements undertaken to provide navigation services for aircraft.

(b) Regulations made under this Article may apply either generally or in relation to any class of aircraft.

(2) If the commander of an aircraft becomes aware that the aircraft is flying in contravention of any regulations which have been made for any of the reasons referred to in paragraph (1)(a)(iii) of this Article he shall unless otherwise instructed pursuant to paragraph (3) of this Article cause the aircraft to leave the area to which the regulations relate by flying to the least possible extent over such area and the aircraft shall not begin to descend while over such an area.

(3) The commander of an aircraft flying either within an area for which regulations have been made for any of the reasons referred to in paragraph (1)(a)(iii) of this Article or within airspace notified as a Danger Area shall forthwith comply with instructions given by radio or by one of the prescribed visual signals by the appropriate air traffic control unit or by, or on behalf of, the person responsible for safety within the relevant airspace.

Balloons, kites, airships, gliders and parascending parachutes

70.—(1) Within Hong Kong—

- (a) a captive balloon or kite shall not be flown at a height of more than 60 metres above the ground level or within 60 metres of any vessel, vehicle or structure;
- (b) a captive balloon shall not be flown within five kilometres of an aerodrome;
- (c) a balloon exceeding two metres in any linear dimension at any stage of its flight, including any basket or other equipment attached to the balloon, shall not be flown in controlled airspace;
- (d) a kite shall not be flown within five kilometres of an aerodrome;
- (e) an airship shall not be moored;

- (f) a glider or parascending parachute shall not be launched by winch and cable or by ground or sea tow to a height of more than 60 metres above ground or sea level;
 - (g) a parascending parachute shall not be launched within five kilometres of an airfield;
- without the permission in writing of the Governor and in accordance with any conditions subject to which that permission may be granted.

(2) A captive balloon when not in flight shall be securely moored, shall not be left unattended and shall be fitted with a device which ensures its automatic deflation if it breaks free of its moorings.

PART IX

AERODROMES, AERONAUTICAL LIGHTS AND DANGEROUS LIGHTS

Aerodromes: public transport of passengers and instruction in flying

71.—(1) An aircraft to which this paragraph applies shall not take-off or land at a place in Hong Kong other than—

- (a) an aerodrome licensed under this Order for the take-off and landing of such aircraft; or
- (b) a government aerodrome notified as available for the take-off and landing of such aircraft, or in respect of which the person in charge of the aerodrome has given his permission for the particular aircraft to take-off or land as the case may be,

and in accordance with any condition subject to which the aerodrome may have been so licensed or notified, or subject to which such permission may have been given.

(2) Paragraph (1) of this Article applies to—

- (a) aeroplanes of which the maximum total weight authorised exceeds 2,730 kg and which are flying—
 - (i) for the purpose of the public transport of passengers; or
 - (ii) for the purpose of instruction in flying given to any person for the purpose of becoming qualified for the grant of a pilot's licence or the inclusion of an aircraft rating or a night rating in a licence; or
 - (iii) for the purpose of carrying out flying tests in respect of the grant of a pilot's licence or the inclusion of an aircraft rating or a night rating in a licence;
- (b) aeroplanes of which the maximum total weight authorised does not exceed 2,730 kg engaged on either—
 - (i) scheduled journeys for the purpose of the public transport of passengers; or
 - (ii) flights for the purpose of the public transport of passengers beginning and ending at the same aerodrome; or
 - (iii) flights for the purpose of—
 - (aa) instruction in flying given to any person for the purpose of becoming qualified for the grant of a pilot's licence or the inclusion of an aircraft rating or a night rating in a licence; or
 - (bb) a flying test in respect of the grant of a pilot's licence or the inclusion of an aircraft rating or a night rating in a licence; or
 - (iv) flights for the purpose of the public transport of passengers at night;
- (c) helicopters and gyroplanes engaged on such flights as are specified in sub-paragraphs (b) (i), (ii) and (iii) above;

- (d) gliders (other than gliders being flown under arrangements made by a flying club and carrying no person other than a member of the club) which are flying for the purpose of the public transport of passengers or for the purpose of instruction in flying.
- (a) (3) (a) The person in charge of any area in Hong Kong intended to be used for the taking-off or landing of helicopters at night other than such a place as is specified in paragraph (1) of this Article shall cause to be in operation, whenever a helicopter flying for the purpose of public transport of passengers is taking-off or landing at that area by night, such lighting as will enable the pilot of the helicopter—
 - (i) in the case of landing, to identify the landing area in flight, to determine the landing direction and to make a safe approach and landing;
 - (ii) in the case of taking-off, to make a safe take-off.
- (b) A helicopter flying for the purpose of the public transport of passengers at night shall not take-off or land at a place to which sub-paragraph (a) of this paragraph applies unless there is in operation such lighting.

Use of Government aerodromes

72. The Governor may cause to be notified subject to such conditions as he thinks fit any Government aerodrome as an aerodrome available for the take-off and landing of aircraft engaged on flights for the purpose of the public transport of passengers or for the purpose of instruction in flying or of any classes of such aircraft.

Licensing of aerodromes

73.—(1) The Governor may grant to any person applying therefor a licence in respect of any aerodrome in Hong Kong if he is satisfied that—

- (a) that person is competent, having regard to his previous conduct and experience, his equipment, organisation, staffing, maintenance and other arrangements, to secure that the aerodrome is safe for use by aircraft; and
- (b) the aerodrome is safe for use by aircraft, having regard in particular to the physical characteristics of the aerodrome and of its surroundings; and
- (c) the aerodrome manual submitted pursuant to paragraph (7) of this Article is adequate.

(2) An aerodrome licence may be granted subject to such conditions as the Governor thinks fit and shall, subject to the provisions of Article 62 of this Order, remain in force for the period specified in the licence.

(3) Without prejudice to the generality of paragraph (2) of this Article, the Governor may grant a licence (in this Order referred to as “a licence for public use”) which shall be subject to the condition that the aerodrome shall at all times when it is available for the take-off or landing of aircraft be so available to all persons on equal terms and conditions.

(4) The holder of an aerodrome licence granted under this Order (in this Article called “an aerodrome licence holder”) shall—

- (a) furnish to any person on request information concerning the terms of the licence; and
- (b) in the case of a licence for public use, cause to be notified the times during which the aerodrome will be available for the take off or landing of aircraft engaged on flights for the purpose of the public transport of passengers or cargo, instruction in flying including the carrying out of flying tests in respect of the grant or renewal of a pilot’s licence or the inclusion or renewal of a rating included in a licence.

(5) An aerodrome licence holder shall not contravene or cause or permit to be contravened any condition of the aerodrome licence at any time in relation to such aircraft engaged on such flights

as are specified in article 71(2) of this Order, but the licence shall not cease to be valid by reason only of such a contravention.

(6) An aerodrome licence holder shall take all reasonable steps to secure that the aerodrome and the airspace within which its visual traffic pattern is normally contained are safe at all times for use by aircraft.

- (a) (7) (a) Upon making an application for an aerodrome licence the applicant shall submit to the Governor an aerodrome manual for that aerodrome.
- (b) Unless previously submitted pursuant to sub-paragraph (a) of this paragraph, every aerodrome licence holder shall forthwith submit to the Governor an aerodrome manual for that aerodrome.

(8) An aerodrome manual required pursuant to this Article shall contain all such information and instructions as may be necessary to enable the aerodrome operating staff to perform their duties as such including, in particular, information and instructions relating to the matters specified in Schedule 4 to this Order.

(9) Every aerodrome licence holder shall:

- (a) furnish to the Governor any amendments or additions to the aerodrome manual before or immediately after they come into effect;
 - (b) without prejudice to the foregoing sub-paragraph, make such amendments or additions to the aerodrome manual as the Governor may require for the purpose of ensuring the safe operation of aircraft at the aerodrome or the safety of air navigation; and
 - (c) maintain the aerodrome manual and make such amendments as may be necessary for the purposes of keeping its contents up to date.
- (a) (10) (a) Every aerodrome licence holder shall make available to each member of the aerodrome operating staff a copy of the aerodrome manual, or a copy of every part of the aerodrome manual which is relevant to his duties; and shall ensure that each copy is kept up to date.
- (b) Every aerodrome licence holder shall take all reasonable steps to secure that each member of the aerodrome operating staff:
 - (i) is aware of the contents of every part of the aerodrome manual which is relevant to his duties as such; and
 - (ii) undertakes his duties as such in conformity with the relevant provisions of the manual.

(11) For the purposes of this Article:

“aerodrome operating staff” means all persons, whether or not the aerodrome licence holder and whether or not employed by the aerodrome licence holder, whose duties are concerned either with ensuring that the aerodrome and airspace within which its visual traffic pattern is normally contained are safe for use by aircraft, or whose duties require them to have access to the aerodrome manoeuvring area or apron.

Aeronautical radio stations

74.—(1) A person shall not cause or permit any aeronautical radio station to be established or used unless its purpose has been approved by the Governor and the equipment thereof is of a type the specification of which is approved by the Governor in relation to the purpose for which it is to be used.

(2) The person in charge of an aeronautical radio station the purpose of which is to provide navigational aid by radio or radar to an aircraft making an approach to land or landing at an

aerodrome shall not cause or permit that aeronautical radio station to provide such navigational aid unless all aeronautical radio stations operated by that person at that aerodrome are:

- (a) installed, modified and maintained in a manner approved by the Governor; and
- (b) flight checked by the Governor or by a person approved by the Governor for that purpose on such occasions as the Governor may require:

Provided that the provisions of this paragraph shall not apply to any aeronautical radio station which is used solely for the purpose of enabling communications to be made by or on behalf of the operator of an aircraft and the commander thereof.

(3) The person in charge of an aeronautical radio station at an aerodrome for which a licence for public use has been granted shall cause to be notified in relation to that aeronautical radio station the type and hours of operation of any service which is available for use by any aircraft, and in approving the purpose for which an aeronautical radio station is to be used at any other aerodrome the Governor may if he thinks fit require the person in charge of the aeronautical radio station to cause such information as aforesaid to be notified.

(4) The provisions of this Article shall not apply in respect of any aeronautical radio station of which the person in charge is the Governor.

Aeronautical radio station records

75.—(1) The person in charge of any aeronautical radio station the purpose of which is to provide navigational aid by radio or radar to an aircraft making an approach to land or landing at an aerodrome shall in respect of all aeronautical radio stations operated by him at that aerodrome:

- (a) keep a written record of functional tests, flight checks and particulars of any overhaul, repair, replacement or modification thereof; and
- (b) preserve the written record for a period of one year or such longer periods as the Governor may in a particular case direct and shall within a reasonable time after being requested to do so by an authorised person produce such record to that person.

(2) The person in charge of an aeronautical radio station which is used for the provision of an air traffic control service by an air traffic control unit shall provide apparatus which is capable of recording the terms of content of any radio message or signal transmitted to any aircraft either alone or in common with other aircraft or received from any aircraft by the air traffic control unit.

(3) The apparatus provided in compliance with paragraph (2) of this Article shall be:

- (a) of a type the specification of which is approved by the Governor in relation to the particular aeronautical radio station; and
- (b) installed, modified and maintained in a manner approved by the Governor; and
- (c) in operation at all times when the aeronautical radio station is in operation for providing an air traffic control service.

(4) The person in charge of an aeronautical radio station shall ensure that each record made by the apparatus provided in compliance with paragraph (2) of this Article includes:

- (a) the identification of the aeronautical radio station; and
- (b) the date or dates on which the record was made; and
- (c) a means of determining the time at which each message or signal was transmitted; and
- (d) the identity of the aircraft to or from which and the radio frequency on which the message or signal was transmitted or received; and
- (e) the time at which the record started and finished.

(5) If at any time the apparatus provided in compliance with paragraph (2) of this Article ceases to be capable of recording the matters required by this Article to be included in the record the person

in charge of the aeronautical station shall ensure that a written record is kept in which the particulars specified in paragraph (4) of this Article are recorded together with a summary of communications exchanged between the aeronautical radio station and aircraft.

(6) The person in charge of the aeronautical radio station shall preserve any record made in compliance with paragraphs (2) and (5) of this Article for a period of 30 days from the date on which the message or signal was recorded or for such longer period as the Governor may in a particular case direct, and shall, within a reasonable time after being requested to do so by an authorised person, produce such record to that person.

(7) A person required by this Article to preserve any record by reason of his being the person in charge of the aeronautical radio station shall, if he ceases to be such person, continue to preserve the record as if he had not ceased to be such person, and in the event of his death the duty to preserve the record shall fall upon his personal representative:

Provided that if another person becomes the person in charge of the aeronautical radio station the previous person in charge or his personal representative shall deliver the record to that other person on demand, and it shall be the duty of that other person to deal with the record delivered to him as if he were that previous person in charge.

(8) The provisions of this Article shall not apply in respect of any aeronautical radio station of which the person in charge is the Governor.

Charges at aerodromes licensed for public use

76.—(1) The Governor may, in relation to any aerodrome in respect of which a licence for public use has been granted, or to such aerodromes generally or to any class thereof, prescribe the charges, or the maximum charges, which may be made for the use of the aerodrome and for any services performed at the aerodrome to or in connection with aircraft, and may further prescribe the conditions to be observed in relation to those charges and the performance of those services.

(2) The licensee of an aerodrome in relation to which the Governor has made any regulations under paragraph (1) of this Article shall not cause or permit any charges to be made in contravention of those regulations and shall cause particulars of the prescribed charges to be kept exhibited at the aerodrome in such a place and manner as to be readily available for the information of any person affected thereby.

(3) The licensee of any aerodrome in respect of which a licence for public use has been granted shall, when required by the Governor, furnish to the Governor such particulars as he may require of the charges established by the licensee for the use of the aerodrome or of any facilities provided at the aerodrome for the safety, efficiency or regularity of air navigation.

Use of aerodromes by aircraft of Contracting States

77. The person in charge of any aerodrome in Hong Kong which is open to public use by aircraft registered in Hong Kong (whether or not the aerodrome is a licensed aerodrome) shall cause the aerodrome, and all air navigation facilities provided thereat, to be available for use by aircraft registered in other Contracting States on the same terms and conditions as for use by aircraft registered in Hong Kong.

Noise and vibration caused by aircraft on aerodromes

78. The conditions under which noise and vibration may be caused by aircraft (including military aircraft) on Government aerodromes, licensed aerodromes or on aerodromes at which the manufacture, repair or maintenance of aircraft is carried out by persons carrying on business as manufacturers or repairers of aircraft shall be as specified in Regulation 12 in Schedule 15 to this Order.

Aeronautical lights

79.—(1) Except with the permission of the Governor and in accordance with any conditions subject to which the permission may be granted, a person shall not establish, maintain or alter the character of;

- (a) an aeronautical beacon within Hong Kong:

Provided that, in the case of an aeronautical beacon which is or may be visible from the waters within an area of a lighthouse authority, the Governor shall not give permission for the purpose of this Article except with the consent of that authority, or

- (b) any aeronautical ground light (other than an aeronautical beacon) at an aerodrome licensed under this Order, or which forms part of the lighting system for use by aircraft taking off from or landing at such an aerodrome.

(2) A person shall not intentionally or negligently damage or interfere with any aeronautical ground light established by or with the permission of the Governor.

Dangerous lights

80.—(1) A person shall not exhibit in Hong Kong any light which—

- (a) by reason of its glare is liable to endanger aircraft taking off from or landing at an aerodrome; or
 (b) by reason of its liability to be mistaken for an aeronautical ground light is liable to endanger aircraft.

(2) If any light which appears to the Governor to be such a light as aforesaid is exhibited the Governor may cause a notice to be served upon the person who is the occupier of the place where the light is exhibited or having charge of the light, directing that person, within a reasonable time to be specified in the notice, to take such steps as may be specified in the notice of extinguishing or screening the light and of preventing for the future the exhibition of any other light which may similarly endanger aircraft.

(3) The notice may be served either personally or by post, or by affixing it in some conspicuous place near to the light to which it relates.

(4) In the case of a light which is or may be visible from any waters within the area of a lighthouse authority, the powers of the Governor under this Article shall not be exercised except with the consent of that authority.

Customs and Excise airports

81.—(1) The Governor may, subject to such conditions as he may think fit, by order designate any aerodrome to be a place for the landing or departure of aircraft for the purpose of the enactments for the time being in force relating to customs and excise.

- (2) The Governor may by order revoke any designation so made.

Aviation Fuel at Aerodromes

82.—(1) A person who has the management of any aviation fuel installation on an aerodrome in Hong Kong shall not cause or permit any fuel to be delivered to that installation or from it to an aircraft unless:—

- (a) when the aviation fuel is delivered into the installation he is satisfied that;
 (i) the installation is capable of storing and dispensing the fuel so as not to render it unfit for use in aircraft; and

- (ii) the installation is marked in a manner appropriate to the grade of fuel stored or if different grades are stored in different parts each part is so marked; and
 - (iii) in the case of delivery into the installation or part thereof from a vehicle or vessel, the fuel has been sampled and is of a grade appropriate to that installation or that part of the installation as the case may be and is fit for use in aircraft;
- (b) when any aviation fuel is dispensed from the installation he is satisfied as the result of sampling that the fuel is fit for use in aircraft:

Provided that this paragraph shall not apply in respect of fuel which has been removed from an aircraft and is intended for use in another aircraft operated by the same operator as the aircraft from which it has been removed.

(2) A person to whom paragraph (1) of this Article applies shall keep a written record in respect of each installation of which he has the management, which record shall include—

- (a) particulars of the grade and quantity of aviation fuel delivered and the date of delivery;
- (b) particulars of all samples taken of the aviation fuel and of the results of tests of those samples;
- (c) particulars of the maintenance and cleaning of the installation;

and he shall preserve the written record for a period of 12 months or such longer period as the Governor may in a particular case direct and shall, within a reasonable time after being requested to do so by an authorised person, produce such record to that person.

- (a) (3) (a) A person shall not cause or permit any aviation fuel to be dispensed for use in an aircraft if he knows or has reason to believe that the aviation fuel is not fit for use in aircraft.
- (b) If it appears to the Governor or an authorised person that any aviation fuel is intended or likely to be delivered in contravention of any provision of this Article, the Governor or that authorised person may direct the person having the management of the installation not to permit aviation fuel to be dispensed from that installation until the direction has been revoked by the Governor or by an authorised person.

(4) For the purpose of this Article—

“aviation fuel” means fuel intended for use in aircraft;

“aviation fuel installation” means any apparatus or container, including a vehicle, designed, manufactured or adapted for the storage of aviation fuel or for the delivery of such fuel to an aircraft.

PART X GENERAL

83. Deleted.

Restriction with respect to aerial photography and survey from aircraft registered outside Hong Kong

84.—(1) An aircraft registered in a Contracting State other than the United Kingdom or Hong Kong, or in a foreign country, shall not fly over Hong Kong for the purpose of aerial photography or aerial survey (whether or not hire or reward is given or promised in respect of the flight or the purpose of the flight) or for the purpose of any other form of aerial work except with the permission of the Governor granted under this Article to the operator or the charterer of the aircraft and in accordance with any conditions to which such permission may be subject.

(2) Without prejudice to the provisions of paragraph (1) of this Article, any breach by a person to whom a permission has been granted under this Article of any condition to which that permission was subject shall constitute a contravention of this Article.

Flights over any foreign country

85.—(1) The operator or commander of an aircraft registered in Hong Kong (or, if the operator's principal place of business or permanent residence is in Hong Kong, any other aircraft) which is being flown over any foreign country shall not allow that aircraft to be used for a purpose which is prejudicial to the security, public order or public health of, or to the safety of air navigation in relation to, that country.

(2) A person does not contravene paragraph (1) of this Article if he neither knew nor suspected that the aircraft was being or was to be used for a purpose referred to in paragraph (1).

(3) The operator or commander of an aircraft registered in Hong Kong (or, if the operator's principal place of business or permanent residence is in Hong Kong, any other aircraft) which is being flown over any foreign country shall comply with any directions given by the appropriate aeronautical authorities of that country whenever—

- (a) the flight has not been duly authorised; or
- (b) there are reasonable grounds for the appropriate aeronautical authorities to believe that the aircraft is being or will be used for a purpose which is prejudicial to the security, public order or public health of, or to the safety of air navigation in relation to, that country;

unless the lives of persons on board or the safety of the aircraft would thereby be endangered.

(4) A person does not contravene paragraph (3) of this Article if he neither knew nor suspected that directions were being given by the appropriate aeronautical authorities.

(5) The requirement in paragraph (3) of this Article is without prejudice to any other requirement to comply with directions of an aeronautical authority.

(6) In this Article 'appropriate aeronautical authorities' includes any person, whether a member of a country's military or civil authorities, authorised under the law of the foreign country to issue directions to aircraft flying over that country.

Mandatory reporting

86.—(1) Subject to the provisions of this Article, every person who—

- (a) is the operator or the commander of a public transport aircraft which is registered in Hong Kong and has a maximum total weight authorised of more than 2,300 kg; or
- (b) carries on the business of manufacturing, repairing or overhauling such an aircraft, or any equipment or part thereof; or
- (c) signs a certificate of maintenance review, or of release to service in respect of such an aircraft, part or equipment; or
- (d) performs a function for which he requires an air traffic controller's licence; or
- (e) is the licensee or manager of a licensed aerodrome,

shall—

- (i) make a report to the Governor of any reportable occurrence of which he knows and which is of such a description as is specified in Regulation 16 in Schedule 15 to this Order. The report shall be made within such time, by such means, and shall contain such information as is so specified and it shall be presented in such form as the Governor may in any particular case approve, and

- (ii) make a report to the Governor, within such time, by such means, and containing such information as the Governor may specify in a notice in writing served upon him, being information which is in his possession or control and which relates to a reportable occurrence which has been reported by him or by another person to the Governor in accordance with this Article.

(2) In this Article “reportable occurrence” means—

- (a) any incident relating to such an aircraft or any defect in or malfunctioning of such an aircraft or any part or equipment of such an aircraft, being an incident, malfunctioning or defect endangering, or which if not corrected would endanger, the aircraft, its occupants, or any other person; and
- (b) any defect in or malfunctioning of any facility on the ground used or intended to be used for purposes of or in connection with the operation of such an aircraft, being a defect or malfunctioning endangering, or which if not corrected would endanger, such an aircraft or its occupants:

Provided that any accident notified to the Governor in pursuance of regulations made under the Hong Kong Civil Aviation (Investigation of Accidents) Regulations 1983, as amended, shall not constitute a reportable occurrence for the purposes of this Article.

(3) Subject to paragraph (1)(ii) of this Article, nothing in this Article shall require a person to report any occurrence which he has reason to believe has been or will be reported by another person to the Governor in accordance with this Article.

(4) A person shall not make any report under this Article if he knows or has reason to believe that the report is false in any particular.

(5) Without prejudice to Article 37(2), (4) and (5) and subject to the provisions of Article 61 of this Order, the operator of an aircraft shall, if he has reason to believe that a report has been or will be made in pursuance of this Article, preserve any data from a flight data recorder or a combined cockpit voice recorder/flight data recorder relevant to the reportable occurrence for fourteen days from the date on which a report of that occurrence is made to the Governor or for such longer period as the Governor may in a particular case direct:

Provided that the record may be erased if the aircraft is outside Hong Kong and it is not reasonably practicable to preserve the record until the aircraft reaches Hong Kong.

Power to prevent aircraft flying

87.—(1) If it appears to the Governor or an authorised person that any aircraft is intended or likely to be flown—

- (a) in such circumstances that any provision of Article 3, 5, 6, 7, 18, 19, 28, 37, 43 or 44 of this Order would be contravened in relation to the flight; or
- (b) in such circumstances that the flight would be in contravention of any other provision of this Order or any regulations made thereunder and be a cause of danger to any person or property whether or not in the aircraft; or
- (c) while in a condition unfit for the flight, whether or not the flight would otherwise be in contravention of any provision of this Order or of any regulation made thereunder,

the Governor or that authorised person may direct the operator or the commander of the aircraft that he is not to permit the aircraft to make the particular flight or any other flight of such description as may be specified in the direction, until the direction has been revoked by the Governor or by an authorised person, and the Governor or that authorised person may take such steps as are necessary to detain the aircraft.

(2) For the purposes of paragraph (1) of this Article the Governor or any authorised person may enter upon and inspect any aircraft.

(3) If it appears to the Governor or an authorised person that any aircraft is intended or likely to be flown in such circumstances that any provision of Article 84 or 85 of this Order or any provision relating to the licensing of air transport in Hong Kong would be contravened in relation to the flight, the Governor or that authorised person may direct the operator or the commander of the aircraft that he is not to permit the aircraft to make the particular flight or any other flight of such description as may be specified in the direction until the direction has been revoked by the Governor or by an authorised person, and the Governor or any authorised person may take such steps as are necessary to detain the aircraft.

(4) For the purposes of paragraph (3) of this Article the Governor or any authorised person may enter upon any aerodrome and may enter upon and inspect any aircraft.

Right of access to aerodromes and other places

88. The Governor and any authorised person shall have the right of access at all reasonable times—

- (a) to any aerodrome, for the purpose of inspecting the aerodrome, or
- (b) to any aerodrome for the purpose of inspecting any aircraft on the aerodrome or any document which he has power to demand under this Order, or for the purpose of detaining any aircraft under the provisions of this Order; and
- (c) to any place where an aircraft has landed, for the purpose of inspecting the aircraft or any document which he has power to demand under this Order and for the purpose of detaining the aircraft under the provisions of this Order:

Provided that access to a Government aerodrome shall only be obtained with the permission of the person in charge of the aerodrome.

Obstruction of persons

89. A person shall not intentionally obstruct or impede any person acting in the exercise of his powers or the performance of his duties under this Order.

Enforcement of directions

90. Any person who without reasonable excuse fails to comply with any direction given to him under any provision of this Order or any regulations made thereunder shall be deemed for the purpose of this Order to have contravened that provision.

Penalties

91.—(1) If any provision of this Order or of any regulations made thereunder is contravened in relation to an aircraft, the operator of that aircraft and the commander thereof shall (without prejudice to the liability of any other person under this Order for that contravention) be deemed for the purposes of the following provisions to have contravened that provision unless he proves that the contravention occurred without his consent or connivance and that he exercised all due diligence to prevent the contravention.

(2) If it is proved that an act or omission of any person which would otherwise have been a contravention by that person of a provision of this Order or of any regulations made thereunder was due to any cause not avoidable by the exercise of reasonable care by that person the act or omission shall be deemed not to be a contravention by that person of that provision.

(3) Where a person is charged with contravening a provision of this Order or of any regulations made thereunder by reason of his having been a member of the flight crew of an aircraft on a flight for the purpose of public transport or aerial work the flight shall be treated (without prejudice to the liability of any other person under this Order) as not having been for that purpose if he proves that he neither knew nor suspected that the flight was for that purpose.

(4) If any person contravenes any provision of this Order, or of any regulations made thereunder, not being a provision referred to in paragraphs (5) or (6) of this Article, he shall be guilty of an offence and liable on summary conviction to a fine not exceeding \$2,500.

(5) If any person contravenes any provision specified in Part A of Schedule 13 to this Order he shall be guilty of an offence and liable on summary conviction to a fine not exceeding \$5,000.

(6) If any person contravenes any provision specified in Part B of the said Schedule he shall be guilty of an offence and liable on summary conviction to a fine not exceeding \$5,000 and on conviction on indictment to a fine or imprisonment for a term not exceeding two years or both.

Extra-territorial effect of the Order

92.—(1) Except where the context otherwise requires, the provisions of this Order,

- (a) in so far as they apply (whether by express reference or otherwise) to aircraft registered in Hong Kong, shall apply to such aircraft wherever they may be;
- (b) in so far as they apply as aforesaid to other aircraft shall apply to such other aircraft when they are within Hong Kong;
- (c) in so far as they prohibit, require or regulate (whether by express reference or otherwise) the doing of anything by persons in, or by any of the crew of, any aircraft registered in Hong Kong, shall apply to such persons and crew, wherever they may be; and
- (d) in so far as they prohibit, require or regulate as aforesaid the doing of anything in relation to any aircraft registered in Hong Kong by other persons shall, where such persons are Commonwealth citizens or British protected persons, apply to them wherever they may be.

(2) Nothing in this Article shall be construed as extending to make any person guilty of an offence in any case in which it is provided by section 3(1) of the British Nationality Act 1948⁽⁸⁾(which limits the criminal liability of certain persons) that that person shall not be guilty of an offence.

Application of Order to British-controlled aircraft not registered in Hong Kong

93. The Governor may direct that such of the provisions of this Order and of any regulations made or having effect thereunder as may be specified in the direction shall have effect as if reference in those provisions to aircraft registered in Hong Kong included references to the aircraft specified in the direction, being an aircraft not so registered but for the time being under the management of a person who, or of persons each of whom, is qualified to hold a legal or beneficial interest by way of ownership in an aircraft registered in Hong Kong.

Application of Order to the Crown and visiting forces etc

94.—(1) Subject to the following provisions of this Article, the provision of this Order shall apply to or in relation to aircraft belonging to or exclusively employed in the service of Her Majesty, as they apply to or in relation to other aircraft and for the purposes of such application the Department or other authority for the time being responsible on behalf of Her Majesty for the management of the aircraft shall be deemed to be the operator of the aircraft and in the case of an aircraft belonging to Her Majesty, to be the owner of the interest of Her Majesty in the aircraft:

⁽⁸⁾ 1948 c. 56.

Provided that nothing in this Article shall render liable to any penalty any Department or other authority responsible on behalf of Her Majesty for the management of any aircraft.

(2) Save as otherwise expressly provided the naval, military and air force authorities and members of any visiting force and any international headquarters and the members thereof and property held or used for the purpose of such a force or headquarters shall be exempt from the provisions of this Order and of any regulations made thereunder to the same extent as if that force or headquarters formed part of the forces of Her Majesty raised in the United Kingdom and for the time being serving in Hong Kong.

(3) Save as otherwise provided by paragraph (4) of this Article, Article 78 of this Order and the Rules of the Air, nothing in this Order shall apply to or in relation to any military aircraft.

(4) Where a military aircraft is flown by a civilian pilot and is not commanded by a person who is acting in the course of his duty as a member of any of Her Majesty's naval, military or air forces or as a member of a visiting force or international headquarters, the following provisions of this Order shall apply on the occasion of that flight, that is to say, Articles 47, 48, 49 and 69 and in addition Article 64 (so far as applicable) shall apply unless the aircraft is flown in compliance with Military Flying Regulations (Joint Service Publication 318) of Flying Orders to contractors (Aviation Publication 67) issued by the Secretary of State.

Exemption from Order

95. The Governor may exempt from any of the provisions of this Order (other than Articles 84 and 96 thereof) or any regulations made thereunder, any aircraft or persons or classes of aircraft or persons, either absolutely or subject to such conditions as he thinks fit.

Appeal to Supreme Court

96.—(1) An appeal shall lie to the High Court of Justice of Hong Kong from any decision of the Governor that a person is not a fit person to hold a licence to act as an aircraft maintenance engineer, member of the flight crew of an aircraft, air traffic controller, student air traffic controller or aerodrome flight information service officer, and if the court is satisfied that on the evidence submitted to the Governor he was wrong in so deciding, the court may reverse the Governor's decision and the Governor shall give effect to the court's determination:

Provided that an appeal shall not lie from a decision of the Governor that a person is not qualified to hold the licence by reason of a deficiency in his knowledge, experience, competence, skill, physical or mental fitness.

(2) The respondent to any appeal under this Article shall be the Attorney General of Hong Kong.

(3) For the purposes of any provision relating to the time within which an appeal may be brought, the Governor's decision shall be deemed to have been taken on the date on which the Governor furnished a statement of his reasons for the decision to the applicant for the licence, or as the case may be, the holder or former holder of it.

Regulations by the Governor: Fees

97.—(1) The Governor may make regulations for prescribing anything which, under the provisions of this Order, is to be prescribed.

(2) The Governor may make regulations amending the Air Navigation (General) Regulations contained in Schedule 15 to this Order.

(3) Without prejudice to the generality of paragraph (1) of this Article, such regulations may prescribe the fees to be charged in connection with the issue, validation, renewal, extension or variation of any certificate, licence or other document (including the issue of a copy thereof), or the

undergoing of any examination, test, inspection or investigation or the grant of any permission or approval, required by, or for the purpose of, this Order or any regulations made thereunder.

(4) Upon an application being made in connection with which any fee is chargeable in accordance with the said provisions the applicant may be required before the application is entertained to pay the whole or to deposit a portion of the fee or fees so chargeable. If, after such payment or deposit has been made, the application is withdrawn by the applicant or otherwise ceases to have effect or is refused by the Governor, the Governor may, subject as hereinafter provided, refund the amount of such payment or deposit. Where the amount paid or deposited is wholly or to any extent attributable to a fee chargeable in respect of an investigation which would have been carried out in connection with the application if it had not been so withdrawn or ceased to have effect or been refused but which has not been carried out by reason only of such withdrawal, cesser or refusal, the Governor may refund the amount so attributable or, in a case where an investigation has been partially completed, so much of that amount as in the opinion of the Governor is reasonable having regard to the stage to which the investigation has progressed at the time of such withdrawal, cesser or refusal:

Provided that, if in any case the amount deposited by the applicant is not sufficient to cover the fee, as ultimately assessed, chargeable in respect of any investigation in so far as the same has been carried out at the time when the application is withdrawn by him or otherwise ceases to have effect or is refused by the Governor the amount representing the balance of such fee shall be payable by the applicant.

In this paragraph the expression “investigation” includes an inspection, examination, calculation or test.

Interpretation

98.—(1) In this Order, unless the context otherwise requires—

“The Act” means the Civil Aviation Act 1949(9);

“Aerial work” means any purpose (other than public transport) for which an aircraft is flown if hire or reward is given or promised in respect of the flight or the purpose of the flight;

“Aerial work aircraft” means an aircraft (other than a public transport aircraft) flying, or intended by the operator to fly, for the purpose of aerial work;

“Aerial work undertaking” means an undertaking whose business includes the performance of aerial work;

“Aerobatic manoeuvres” includes loops, spins, rolls, bunts, stall turns, inverted flying and any other similar manoeuvre;

“Aerodrome” means any area of land or water designed, equipped, set apart or commonly used for affording facilities for the landing and departure of aircraft and includes any area or space, whether on the ground, on the roof of a building or elsewhere, which is designed, equipped or set apart for affording facilities for the landing and departure of aircraft capable of descending or climbing vertically, but shall not include any area the use of which for affording facilities for the landing and departure of aircraft has been abandoned and has not been resumed;

“Aerodrome flight information unit” means a person appointed by the Governor or by any other person maintaining an aerodrome to give information by means of radio signals to aircraft flying or intending to fly within the aerodrome traffic zone of that aerodrome and “aerodrome flight information service” shall be construed accordingly;

“Aerodrome operating minima” in relation to the operation of an aircraft at an aerodrome means the cloud ceiling and runway visual range for take-off, and the decision height or

minimum descent height, runway visual range and visual reference for landing, which are the minima for the operation of that aircraft at that aerodrome;

“Aerodrome traffic zone” means the airspace:

- (a) which is in the vicinity of an aerodrome which is notified for the purposes of Rule 35 of Schedule 14 to this Order; and
- (b) which in relation to such an aerodrome:
 - (i) at which the length of the longest runway is notified as 1,850 metres or less, extends from the surface to a height of 2,000 feet above the level of the aerodrome within the area bounded by the circle centred on the notified mid-point of the longest runway and having a radius of 2 nautical miles:

Provided that where such an aerodrome traffic zone would extend less than 1½ nautical miles beyond the end of any runway at the aerodrome and this proviso is notified as being applicable, sub-paragraph (ii) hereof shall apply as though the length of the longest runway is notified as greater than 1,850 metres;

- (ii) at which the length of the longest runway is notified as greater than 1,850 metres, the airspace extends from the surface to a height of 2,000 feet above the level of the aerodrome within the area bounded by a circle centred on the notified mid-point of the longest runway and having a radius of 2½ nautical miles;

except any part of that airspace which is within the aerodrome traffic zone of another aerodrome which is notified for the purposes of this Order as being the controlling aerodrome;

“Aeronautical beacon” means an aeronautical ground light which is visible either continuously or intermittently to designate a particular point on the surface of the earth;

“Aeronautical ground light” means any light specifically provided as an aid to air navigation, other than a light displayed on an aircraft;

“Aeronautical radio station” means a radio station on the surface, which transmits or receives signals for the purpose of assisting aircraft;

“Air traffic control unit” means a person appointed by the Governor or by any other person maintaining an aerodrome or place to give instructions or advice or both instructions and advice by means of radio signals to aircraft in the interests of safety but does not include a person so appointed solely to give information to aircraft, and “Air traffic control service” shall be construed accordingly;

“Air traffic service” shall include an air traffic control service and flight information service.

“Air transport undertaking” means an undertaking whose business includes the carriage by air of passengers or cargo for hire or reward;

“Approach to landing” means that portion of the flight of the aircraft, when approaching to land, in which it is descending below a height of 1,000 feet above the relevant specified decision height or minimum descent height;

“Appropriate aeronautical radio station” means in relation to an aircraft an aeronautical radio station serving the area in which the aircraft is for the time being;

“Appropriate air traffic control unit” means in relation to an aircraft the air traffic control unit serving the area in which the aircraft is for the time being or the air traffic control unit serving the area in which the aircraft intends to enter and with which unit the aircraft is required to communicate prior to entering that area, as the case may be;

“Authorised person” means any person authorised by the Governor either generally or in relation to a particular case or class of cases, and references to a person authorised by the

Governor include references to the holder for the time being of any office designated by the Governor;

“Beneficial interest” has the same meaning as in section 57 of the Merchant Shipping Act 1894⁽¹⁰⁾;

“British national” means a British citizen, a British Dependent Territories citizen, a British Overseas citizen and a British National (Overseas);

“Cargo” includes mail and animals;

“Certificate of airworthiness” includes any validation thereof and any flight manual, performance schedule or other document, whatever its title, incorporated by reference in that certificate relating to the certificate of airworthiness;

“Certificate of maintenance review” and “certificate of release to service” have the meanings respectively assigned to them by Articles 9(1) and 11(5) of this Order;

“The Civil Aviation Authority” refers to the body corporate constituted in accordance with the provisions of section 2 of the Civil Aviation Act 1982⁽¹¹⁾;

“Class A Airspace”, “Class B Airspace”, “Class C Airspace”, “Class D Airspace”, and “Class E Airspace” means airspace respectively notified as such;

“Cloud ceiling” in relation to an aerodrome means the vertical distance from the elevation of the aerodrome to the lowest part of any cloud visible from the aerodrome which is sufficient to obscure more than one-half of the sky so visible;

“Commander” in relation to an aircraft means the member of the flight crew designated as commander of that aircraft by the operator thereof, or, failing such a person, the person who is for the time being the pilot in command of the aircraft;

“The Commonwealth” means the United Kingdom, the Channel Islands, the Isle of Man, the countries mentioned in Schedule 3 to the British Nationality Act 1981⁽¹²⁾ and all other territories forming part of Her Majesty’s dominions or in which Her Majesty has jurisdiction;

“Competent authority” means in relation to Hong Kong, the Governor, and in relation to any other country the authority responsible under the law of that country for promoting the safety of civil aviation;

“Conditional sale agreement” means an agreement for the sale of goods under which the purchase price or part of it is payable by instalments, and the property in the goods is to remain in the seller (notwithstanding that the buyer is to be in possession of the goods) until such conditions as to the payment of instalments or otherwise as may be specified in the agreement are fulfilled;

“Congested area” in relation to a city, town or settlement, means any area which is substantially used for residential, industrial, commercial or recreational purposes;

“Contracting State” means any State (including the United Kingdom and Hong Kong) which is a party to the Convention on International Civil Aviation signed on behalf of the Government of the United Kingdom at Chicago on the 7th December 1944;

“Controlled airspace” means airspace which has been notified as Class A, Class B, Class C, Class D or Class E airspace;

“Control area” means airspace which has been notified as such and which extends upwards from a notified altitude or flight level;

“Control zone” means airspace which has been notified as such and which extends upwards from the surface;

⁽¹⁰⁾ 1894 c. 60.

⁽¹¹⁾ 1982 c. 16.

⁽¹²⁾ 1981 c. 61.

“Co-pilot” in relation to an aircraft means a pilot who in performing his duties as such is subject to the direction of another pilot carried in the aircraft;

“Country” includes a territory except in paragraph (2) of this Article;

“Crew” has the meaning assigned to it by paragraph (4) of this Article;

“Danger Area” shall mean airspace which has been notified as such within which activities dangerous to the flight or aircraft may take place or exist at such times as may be notified;

“Decision height” in relation to the operation of an aircraft at an aerodrome means the height in a precision approach at which a missed approach must be initiated if the required visual reference to continue that approach has not been established;

“Flight” and “to fly” have the meanings respectively assigned to them by paragraph (3) of this Article;

“Flight crew” in relation to an aircraft means those members of the crew of the aircraft who respectively undertake to act as pilot, flight navigator, flight engineer and flight radio operator of the aircraft;

“Flight level” means one of a series of levels of equal atmospheric pressure, separated by notified intervals and each expressed as the number of hundreds of feet which would be indicated at that level on a pressure altimeter calibrated in accordance with the International Standard Atmosphere and set to 1013.2 millibars;

“Flight recording systems” means a system comprising either a flight data recorder or a cockpit voice recorder or both;

“Flight simulator” means apparatus by means of which flight conditions in an aircraft are simulated on the ground;

“Flight visibility” means the visibility forward from the flight deck of an aircraft in flight;

“Government aerodrome” means any aerodrome in Hong Kong which is under the control of the Governor or is in the occupation of any department of the Government of Hong Kong, or of Her Majesty’s naval, military or air forces, or of any visiting force;

“Governor” means—

- (a) the Governor of Hong Kong;
- (b) the Acting Governor;
- (c) to the extent to which a deputy to the Governor is authorised to perform on behalf of the Governor any functions of the Governor, the Deputy to the Governor;
- (d) in relation to any purpose of this Order, other than the purposes of Article 97 thereof, any person authorised by the Governor for that purpose;

“Hong Kong” includes—

- (a) all waters, whether navigable or not, included in Hong Kong; and
- (b) territorial waters of Hong Kong;

“hire-purchase agreement” means an agreement for the bailment of goods under which the bailee may buy the goods, or under which the property in the goods will or may pass to the bailee;

“Instrument Flight Rules” means Instrument Flight Rules contained in the Rules of the Air;

“Instrument Meteorological Conditions” means weather precluding flight in compliance with the Visual Flight Rules;

“To land” in relation to aircraft includes alighting on the water;

“Legal personal representative” has the same meaning as in section 742 of the Merchant Shipping Act 1894(13);

“Licence” includes any certificate of competency or certificate of validity issued with the licence or required to be held in connection with the licence by the law of the country in which the licence is granted;

“Licence for public use” has the meaning assigned to it by Article 73(3) of this Order;

“Licensed aerodrome” means an aerodrome licensed under this Order;

“Lifejacket” includes any device designed to support a person individually in or on the water;

“Log Book” in the case of an aircraft log book, engine log book, variable pitch propeller log book or personal flying log book, includes a record kept either in a book, or by any other means approved by the Governor in the particular case;

“Maximum total weight authorised” in relation to an aircraft means the maximum total weight of the aircraft and its contents at which the aircraft may take off anywhere in the world, in the most favourable circumstances in accordance with the certificate of airworthiness in force in respect of the aircraft;

“Military aircraft” includes the naval, military or air force aircraft of any country and—

- (a) any aircraft being constructed for the naval, military or air forces of any country under a contract entered into by the Secretary of State; and
- (b) any aircraft in respect of which there is in force a certificate issued by the Secretary of State that the aircraft is to be treated for the purposes of this Order as a military aircraft;

“Minimum descent height” in relation to the operation of an aircraft at an aerodrome means the height in a non-precision approach below which descent may not be made without the required visual reference;

“Nautical mile” means the International Nautical Mile, that is to say, a distance of 1,852 metres;

“Night” means the time between half an hour after sunset and half an hour before sunrise, sunset and sunrise being determined at surface level;

“Non-precision approach” means an instrument approach using non-visual aids for guidance in azimuth or elevation but which is not a precision approach;

“Notified” means shown in any of the following publications for the time being in force and issued in Hong Kong whether before or after the coming into operation of this Order, that is to say “Notams (Notices to Airmen)”, “Aeronautical Information Publications (AIP)”, or such other official publications so issued for the purpose of enabling any of the provisions of this Order to be complied with;

“Operator” has the meaning assigned to it by paragraph (5) of this Article;

“Parascending parachute” means a parachute which is towed by cable in such a manner as to cause it to ascend;

“Passenger” means a person other than a member of the crew;

“Pilot in command” in relation to an aircraft means a person who for the time being is in charge of the piloting of the aircraft without being under the direction of any other pilot in the aircraft;

“Precision approach” means an instrument approach using Instrument Landing System, Microwave Landing System or Precision Approach Radar for guidance in both azimuth and elevation;

“Prescribed” means prescribed by regulations made by the Governor under this Order, and the expression “prescribe” shall be construed accordingly;

“Pressurised aircraft” means an aircraft provided with means of maintaining in any compartment a pressure greater than that of the surrounding atmosphere;

“Public transport” has the meaning assigned to it by paragraph (6) of this Article;

“Public transport aircraft” means an aircraft flying, or intended by the operator of the aircraft to fly, for the purpose of public transport.

“Record” includes, in addition to a record in writing—

- (a) any disc, tape, sound-track or other device in which sounds or signals are embodied so as to be capable (with or without the aid of some other instrument) of being reproduced therefrom;
- (b) any film, tape or other device in which visual images are embodied so as to be capable (as aforesaid) of being reproduced therefrom; and
- (c) any photograph;

and any reference to a copy of a record includes, in the case of a record falling within paragraph (a) only of this definition, a transcript of the sounds or signals embodied therein, in the case of a record falling within paragraph (b) only of this definition, a still reproduction of the images embodied therein, and in the case of a record falling within both those paragraphs; such a transcript together with such a still reproduction;

“Replacement” in relation to any part of an aircraft or its equipment includes the removal and replacement of that part whether or not by the same part, and whether or not any work is done on it, but does not include the removal and replacement of a part which is designed to be removable solely for the purpose of enabling another part to be inspected, repaired, removed or replaced or cargo to be loaded;

“Rules of the Air” means the Rules contained in Schedule 14 to this Order and any supplementary rules made by the Governor under Article 64(1) of this Order;

“Runway visual range” in relation to a runway means the distance in the direction of take-off or landing over which the runway lights or surface marking may be seen from the touchdown zone as calculated by either human observation or instruments in the vicinity of the touchdown zone or where this is not reasonably practicable in the vicinity of the midpoint of the runway; and the distance, if any, communicated to the commander of an aircraft by or on behalf of the person in charge of the aerodrome as being the runway visual range shall be taken to be the runway visual range for the time being;

“Scheduled journey” means one of a series of journeys which are undertaken between the same two places and which together amount to a systematic service;

“Seaplane” includes a flying boat and any other aircraft designed to manoeuvre on water;

“Special VFR flight” means a flight made in Instrument Meteorological Conditions or at night in a control zone or in a control zone notified for the purposes of Rule 22 of the Rules of the Air in respect of which the appropriate air traffic control unit has given permission for the flight to be made in accordance with special instructions by that unit instead of in accordance with the Instrument Flight Rules.

“Specified minimum weather provisions” has the meaning assigned to it by paragraph (7) of this Article;

“Visual Flight Rules” means Visual Flight Rules contained in the Rules of the Air;

“Visual Meteorological Conditions” means weather permitting flight in accordance with the Visual Flight Rules.

(2) In relation to Hong Kong the expression “visiting force” in this Order means any such body, contingent or detachment of the forces of any country as is a visiting force for the purposes of any

of the provisions of the Visiting Forces Act 1952(14), which extend to that territory, in respect of that country, by virtue of any Order in Council made under subsection (2) of section 1 or under section 15 of that Act.

- (3) An aircraft shall be deemed to be in flight—
- (a) in the case of a piloted flying machine from the moment when, after the embarkation of its crew for the purpose of taking off, it first moves under its own power, until the moment when it next comes to rest after landing;
 - (b) in the case of a pilotless flying machine, or a glider, from the moment when it first moves for the purpose of taking off until the moment when it next comes to rest after landing;
 - (c) in the case of an airship or free balloon, from the moment when it first becomes detached from the surface until the moment when it next becomes attached thereto or comes to rest thereon;

and the expressions “a flight” and “to fly” shall be construed accordingly.

(4) Every person employed or engaged in an aircraft in flight on the business of the aircraft shall be deemed to be a member of the crew thereof.

(5) References in this Order to the operator of an aircraft are, for the purpose of the application of any provision of this Order in relation to any particular aircraft, references to the person who at the relevant time has the management of that aircraft, and cognate expressions shall be construed accordingly:

Provided that for the purposes of the application of any provision in Part III of this Order, when by virtue of any charter or other agreement for the hire or loan of an aircraft a person other than an air transport undertaking or an aerial work undertaking has the management of that aircraft for a period not exceeding 14 days, the foregoing provisions of this paragraph shall have effect as if that agreement had not been entered into.

- (a) (6) (a) Subject to the provisions of this paragraph, an aircraft in flight shall for the purposes of this Order be deemed to fly for the purpose of public transport—
- (i) if hire or reward is given or promised for the carriage of passengers or cargo in the aircraft on that flight; or
 - (ii) if any passengers or cargo are carried gratuitously in the aircraft on that flight by an air transport undertaking, not being persons in the employment of the undertaking (including, in the case of a body corporate, its directors), persons with the authority of the Governor either making any inspection or witnessing any training, practice or test for the purposes of this Order, or cargo intended to be used by any such passengers as aforesaid, or by the undertaking; or
 - (iii) for the purposes of Part III of this Order, if hire or reward is given or promised for the right to fly the aircraft on that flight (not being a single seater aircraft of which the maximum total weight authorised does not exceed 910 kilograms and in respect of which a certificate of airworthiness of the Special Category is in force) otherwise than under a hire-purchase or conditional sale agreement.

and the expression “public transport of Passengers” shall be construed accordingly:

Provided that, notwithstanding that an aircraft may be flying for the purpose of public transport by reason of sub-paragraph (a)(iii) of this paragraph, it shall not be deemed to be flying for the purpose of the public transport of passengers unless hire or reward is given for the carriage of those passengers.

Provided that, notwithstanding that an aircraft may be flying for the purpose of public transport for the purposes of Part III of this Order by virtue of sub-paragraph (a)(iii) of this paragraph

if the hire or reward given or promised for the primary purpose of conferring on a particular person the right to fly the glider on that flight is given or promised by a member of a flying club and the glider is owned or operated by that flying club.

(b) Where under a transaction effected by or on behalf of a member of an association of persons on the one hand and the association of persons or any member thereof on the other hand, a person is carried in, or is given the right to fly, an aircraft in such circumstances that hire or reward would be given or promised if the transaction were effected otherwise than aforesaid, hire or reward shall, for the purposes of this Order, be deemed to have been given or promised, notwithstanding any rule of law as to such transactions.

(7) The specified minimum weather provisions shall be as follows—

(a) Outside airspace notified for the purposes of Schedule 8 to this Order:

(i) an aircraft flying above 3,000 feet above mean sea level shall remain at least 1,800 metres horizontally and 1,000 feet vertically away from cloud and in a flight visibility of at least 10 km:

(ii) an aircraft other than a helicopter flying at or below 3,000 feet above mean sea level shall remain at least 1,800 metres horizontally and 1,000 feet vertically away from cloud and in a flight visibility of at least 5 km:

Provided that this sub-paragraph shall be deemed to be complied with if the aircraft is flown at a speed which according to its airspeed indicator is 140 knots or less and remains clear of cloud, in sight of the surface and in a flight visibility of at least 1,800 metres;

(iii) a helicopter flying at or below 3,000 feet above mean sea level shall remain clear of cloud and in sight of the surface or at least 1,800 metres horizontally and 1,000 feet vertically away from cloud and in a flight visibility of at least 5 km;

(b) within airspace notified for the purposes of Schedule 8 to this Order an aircraft shall remain at least 1,800 metres horizontally and 1,000 feet vertically away from cloud and in a flight visibility of at least 10 km:

Provided that in a control zone within such airspace, in the case of a special VFR flight the aircraft shall be flown in accordance with any instructions given by the appropriate air traffic control unit.

(8) The expressions appearing in the “General Classification of Aircraft” set forth in Part A of Schedule 1 to this Order shall have the meanings thereby assigned to them.

(9) The Interpretation Act 1978(15) applies for the purpose of the interpretation of this Order and otherwise in relation thereto as it applies for the purpose of the interpretation of, and in relation to, an Act of Parliament of the United Kingdom, and as if this Order were such an Act of Parliament.

(10) A power to make regulations under this Order shall include the power to make different provisions with respect to different circumstances and with respect to different parts of Hong Kong and to make such incidental and supplementary provisions as are necessary or expedient for carrying out the purposes of the Order.

(a) (11) (a) Any power conferred by this Order to issue, make, serve or grant any instrument shall be construed as including a power exercisable, in the like manner and subject to the like conditions, if any, to vary, revoke, cancel or otherwise terminate the instrument.

(b) In this paragraph “instrument” includes any regulations, direction, instruction, rule or other requirement, any notice and any certificate, licence, approval, permission, exemption, authorisation, log book record or other document.

(12) The Governor may delegate any person or body or the person holding any office designated by him to exercise or perform on his behalf any of his powers or duties under this Order other than the power to make regulations under Article 97 and thereupon, or from the date specified by the Governor, the person so delegated shall have and may exercise such powers and shall perform such duties, other than the power to make regulations under Article 97.

Saving

99.—(1) Subject to the provisions of Articles 73 and 77 of this Order, nothing in this Order or the regulations made thereunder shall confer any right to land in any place as against the owner of the land or other persons interested therein.

(2) Nothing in this Order shall oblige the Governor to accept an application from the holder of any current certificate, licence, approval, permission, exemption or other document, being an application for the renewal of that document, or for the granting of another document in continuation or in substitution for the current document, if the application is made more than 60 days before the current document is due to expire.

Small aircraft

100. The provisions of this Order, other than Articles 48, 70, 98(1), and 98(8), shall not apply to or in relation to—

- (a) any balloon which at any stage of its flight is not more than 2 metres in any linear dimension including any basket or other equipment attached to the balloon;
- (b) any kite weighing not more than 2 kg;
- (c) any other aircraft weighing not more than 7 kg without its fuel;
- (d) any parachute including a parascending parachute.

Approval of persons to furnish reports

101. In relation to any of his functions pursuant to any of the provisions of this Order the Governor may, either absolutely or subject to such conditions as he thinks fit, approve a person as qualified to furnish reports to him and may accept such reports.

N. H. Nicholls
Clerk of the Privy Council

Status: This is the original version (as it was originally made). This item of legislation is currently only available in its original format.

SCHEDULE 1

Article 4(6), 23(2) and 99(8)

PART A

TABLE OF GENERAL CLASSIFICATION OF AIRCRAFT

Column 1	Column 2	Column 3	Column 4
Aircraft	{ Lighter than air aircraft	{ Non-power driven	{ Free balloon { Captive balloon
		{ Power driven	{ Airship
		{ Non-power driven	{ Glider
			{ Kite
			{ Aeroplane (Landplane)
	{ Heavier than air aircraft	{ Power driven (flying machines)	{ Aeroplane (Seaplane)
			{ Aeroplane (Amphibian)
			{ Aeroplane (Self-launching motor glider)
			{ Rotorcraft (Helicopter)
			{ Rotorcraft (Gyroplane)

Article 5(2)

PART B

NATIONALITY AND REGISTRATION MARKS
OF AIRCRAFT REGISTERED IN HONG KONG

1. The nationality mark of the aircraft shall be a group of two capital letters in Roman character assigned by the Governor on the registration of the aircraft. The letters shall be without ornamentation and a hyphen shall be placed between the nationality mark and the registration mark.

2. The nationality and registration marks shall be displayed to the best advantage, taking into consideration the constructional features of the aircraft and shall always be kept clean and visible.

3. The letters constituting each group of marks shall be of equal height and they, and the hyphen, shall all be of the same single colour which shall clearly contrast with the background on which they appear.

4. The nationality and registration marks shall also be inscribed, together with the name and address of the registered owner of the aircraft, on a fireproof metal plate affixed in a prominent position—

- (a) in the case of an aeroplane having an empty weight not exceeding 150 kg either in accordance with paragraph (c) or on the wing;
- (b) in the case of a balloon, on the basket or envelope; or
- (c) in the case of any other aircraft on the fuselage or car, as the case may be.

5. The nationality and registration marks shall be painted on the aircraft or shall be affixed thereto by any other means ensuring a similar degree of permanence in the following manner:

I. Position of marks

(a) *Flying Machines and Gliders*

(i) *Horizontal Surfaces of the Wings or Fuselage (or equivalent structure).*

(aa) On aircraft having a fixed wing surface, the marks shall appear on the lower surface of the wing structure, and shall be on the left half of the lower surface of the wing structure unless they extend across the whole surface of both wings. So far as is possible the marks shall be located equidistant from the leading and trailing edges of the wings. The tops of the letters shall be towards the leading edge of the wing.

(bb) On aircraft having no fixed wing surface and when owing to the structure of the aircraft the greatest height reasonably practicable for the marks on the vertical surface of the fuselage (or equivalent structure) is less than 15 centimetres the marks shall also appear on the lower surface of the fuselage on the line of symmetry and shall be placed with the tops of the letters towards the nose.

(ii) *Vertical Surfaces of the Tail or Fuselage (or equivalent structure):* The marks shall also be on each side of the aircraft either on the fuselage or on the upper halves of the vertical tail surfaces. On aircraft having a fixed wing surface, the marks, if placed on the fuselage (or equivalent structure), shall be between the horizontal tail surfaces and the wing. When on a single vertical tail surface, the marks shall be on both sides. When there is more than one vertical tail surface, the marks shall be on the outer sides of the outboard vertical tail surfaces.

(b) *Airships and Free Balloons*

(i) *Airships:* The marks shall be on each side of the airship. They shall be placed horizontally either on the hull near the maximum cross-section of the airship or on the lower vertical stabiliser.

(ii) *Free Balloons:* The marks shall be in two places diametrically opposite.

(iii) In the case of all airships and free balloons the side marks shall be so placed as to be visible both from the sides and from the ground.

II. Size of Marks

(a) *Flying Machines and Gliders*

(i) *Wings:* The letters constituting each group of marks shall be of equal height. The height of the letters shall be at least 50 centimetres.

(ii) *Fuselage (or equivalent structure) or Vertical Tail Surfaces:* The marks on the fuselage (or equivalent structure) shall not interfere with the visible outlines of the fuselage (or equivalent structure). The marks on the vertical tail surfaces shall be such as to leave a margin of at least 5 centimetres along each side of the vertical tail surface. The letters shall be of equal height. The height of the letters constituting each group of marks shall be at least 30 centimetres. Where marks are required to be carried out on the lower surface of aircraft having no fixed wing surface, the height of the marks shall be at least 50 centimetres:

Status: This is the original version (as it was originally made). This item of legislation is currently only available in its original format.

Provided that where owing to the structure of the aircraft the appropriate height specified in this sub-paragraph (ii) is not reasonably practicable, the height of the marks shall be the greatest height reasonably practicable in the circumstances consistent with compliance with Section III of this Part of this Schedule.

(b) *Airships and Free Balloons*

The letters constituting each group of marks shall be of equal height. The height of the letters shall be at least 50 centimetres.

III. Width and Spacing of Marks

- (a) The width of each letter (except the letter I) and the length of the hyphen between the nationality mark and registration mark shall be two-thirds of the height of a letter.
- (b) The letters and hyphen shall be formed by solid lines and shall be of a colour clearly contrasting with the background on which they appear. The thickness of the lines shall be one-sixth of the height of a letter.
- (c) Each letter shall be separated from the letter which it immediately precedes or follows by a space equal to half the width of a letter. A hyphen shall be regarded as a letter for this purpose.

Article 4(8)

PART C

AIRCRAFT DEALER'S CERTIFICATE—CONDITIONS

- (1) The operator of the aircraft shall be the registered owner of the aircraft, who shall be the holder of an aircraft dealer's certificate granted under this Order.
- (2) The aircraft shall fly only for the purpose of:
 - (a) testing the aircraft; or
 - (b) demonstrating the aircraft with a view to the sale of that aircraft or of other similar aircraft; or
 - (c) proceeding to or from a place at which the aircraft is to be tested or demonstrated as aforesaid, or overhauled, repaired or modified; or
 - (d) delivering the aircraft to a person who has agreed to buy, lease or sell it; or
 - (e) proceeding to or from a place for the purpose of storage.
- (3) Without prejudice to the provisions of Article 32 of this Order the operator of the aircraft shall satisfy himself before the aircraft takes off that the aircraft is in every way fit for the intended flight.
- (4) The aircraft shall fly only within Hong Kong.

SCHEDULE 2

Articles 3(1), 7(1) and 39(7)

A and B Conditions

The A Conditions and B Conditions referred to in Article 3(1), 7(1) and 39(7) of this Order are as follows:

A Conditions

Status: This is the original version (as it was originally made). This item of legislation is currently only available in its original format.

- (1) The aircraft shall be either an aircraft in respect of which a certificate of airworthiness or validation has previously been in force under this Order, or an aircraft identical in design with an aircraft in respect of which such a certificate is or has been in force.
- (2) The aircraft shall fly only for the purpose of enabling it to:
 - (a) qualify for the issue or renewal of a certificate of airworthiness or of the validation thereof or the approval of a modification of the aircraft, after an application has been made for each issue, renewal, validation or approval as the case may be;
 - (b) proceed to or from a place at which any inspection, approval, test or weighing of, or the installation of equipment in, the aircraft is to take place for a purpose referred to in sub-paragraph (a), after such an application has been made, or at which the installation of furnishings in, or the painting of, the aircraft is to be undertaken; or
 - (c) proceed to or from a place at which the aircraft is to be or has been stored.
- (3) The aircraft and its engines shall be certified as fit for flight by the holder of an aircraft maintenance engineer's licence granted under this Order, being a licence which entitles him to issue that certificate or by a person approved by the Governor for the purpose of issuing certificates under this condition, and in accordance with that approval.
- (4) The aircraft shall carry the minimum flight crew specified in any certificate of airworthiness or validation, which has previously been in force under this Order in respect of the aircraft, or is or has previously been in force in respect of any other aircraft of identical design.
- (5) The aircraft shall not carry any persons or cargo except persons performing duties in the aircraft in connection with the flight or persons who are carried in the aircraft to perform duties in connection with a purpose referred to in paragraph (2) of these Conditions.
- (6) The aircraft shall not fly over any congested area of a city, town or settlement except to the extent that it is necessary to do so in order to take off from or land at a Government aerodrome or a licensed aerodrome, in accordance with normal aviation practice.
- (7) Without prejudice to the provisions of Article 18(2) of this Order, the aircraft shall carry such flight crew as may be necessary to ensure the safety of the aircraft.

B Conditions

- (1) The flight shall be made under the supervision of a person approved by the Governor for the purpose of these Conditions, and subject to any additional conditions which may be specified in such approval.
- (2) If it is not registered in Hong Kong or under the law of any country referred to in Article 3 of this Order, the aircraft shall be marked in a manner approved by the Governor for the purpose of these Conditions, and the provisions of Articles 14, 15, 19, 32, 35, 57 and 59 of this Order shall be complied with in relation to the aircraft as if it was registered in Hong Kong so far as such provisions are applicable to the aircraft in the circumstances.
- (3) The aircraft shall fly only for the purpose of:
 - (a) experimenting with or testing the aircraft (including in particular its engines) and its equipment;
 - (b) enabling it to qualify for the issue of a certificate of airworthiness or the validation thereof, or the approval of a modification of the aircraft;
 - (c) proceeding to or from a place at which any experiment, inspection, approval, test or weighing of, or the installation of equipment in, the aircraft is to take place for a purpose referred to in sub-paragraph (a) or (b), or at which the installation of furnishings in, or the painting of, the aircraft is to be undertaken; or

Status: This is the original version (as it was originally made). This item of legislation is currently only available in its original format.

- (d) demonstrating the aircraft with a view to the sale of that aircraft or of other similar aircraft.
- (4) Without prejudice to the provisions of Article 18(2) of this Order, the aircraft shall carry such flight crew as may be necessary to ensure the safety of the aircraft.
- (5) The aircraft shall not carry any cargo, or any persons other than the flight crew except the following:
 - (a) persons employed by the operator who carry out during the flight duties in connection with the purposes specified in paragraph (3) of these Conditions;
 - (b) persons employed by manufacturers of component parts of the aircraft (including its engines) who carry out during the flight duties in connection with the purposes so specified;
 - (c) persons approved by the Governor under Article 101 of this Order as qualified to furnish reports for the purposes of Article 8 of this Order;
 - (d) persons, other than those carried under the preceding provisions of this paragraph, who are carried in the aircraft in order to carry out a technical evaluation of the aircraft or its operation.
- (6) The aircraft shall not fly, except in accordance with procedures which have been approved by the Governor in relation to that flight, over any congested area of a city, town or settlement.

SCHEDULE 3

Article 3

CATEGORIES OF AIRCRAFT

Transport Category (Passenger).

Transport Category (Cargo).

Aerial Work Category.

Private Category.

Special Category.

The purposes for which the aircraft may fly are as follows:

Transport Category (Passenger): Any purpose.

Transport Category (Cargo): Any purpose other than the public transport of passengers.

Aerial Work Category: Any purpose other than public transport.

Private Category: Any purpose other than public transport or aerial work.

Special Category: Any purpose, other than public transport, specified in the certificate of airworthiness but not including the carriage of passengers unless expressly permitted.

SCHEDULE 4

Article 73

AERODROME MANUAL

Information and instructions relating to the following matters shall be included in the aerodrome manual referred to in Article 73 of this Order:

- (i) the name and status of the official in charge of day to day operation of the aerodrome together with the names and status of other senior aerodrome operating staff and instructions as to the order and circumstances in which they may be required to act as the official in charge;
- (ii) the system of aeronautical information service available;
- (iii) procedures for promulgating information concerning the aerodrome's state;
- (iv) procedures for the control of access, vehicles and work in relation to the aerodrome manoeuvring area and apron;
- (v) procedures for complying with Article 86 of this Order and for the removal of disabled aircraft;
- (vi) in the case of an aerodrome which has facilities for fuel storage, procedures for complying with Article 82 of this Order;
- (vii) plans to a scale of 1:2500 depicting the layout of runways, taxiways and aprons, aerodrome markings, aerodrome lighting if such lighting is provided, and the siting of any navigational aids within the runway strip:
Provided that in the case of copies of the manual or extracts thereof provided or made available to a member of the aerodrome operating staff, the plans shall be of a scale reasonably appropriate for the purposes of Article 73(10) of this Order;
- (viii) in respect of an aerodrome in relation to which there is a notified instrument approach procedure, survey information sufficient to provide data for the production of aeronautical charts relating to that aerodrome;
- (ix) description, height and location of obstacles which infringe standard obstacle limitation surfaces, and whether they are lit;
- (x) data for and method of calculation of declared distances and elevations at the beginning and end of each declared distance;
- (xi) method of calculating reduced declared distances and the procedure for their promulgation;
- (xii) details of surfaces and bearing strengths of runways, taxiways and aprons;
- (xiii) the system of the management of air traffic in the airspace associated with the aerodrome, including procedures for the coordination of traffic with adjacent aerodromes, except any such information or procedures already published in any manual of air traffic services;
- (xiv) operational procedures for the routine and special inspection of the aerodrome manoeuvring area and aprons;
- (xv) if operations are permitted during periods of low visibility, procedures for the protection of the runways during such periods;
- (xvi) procedures for the safe integration of all aviation activities undertaken at the aerodrome;
- (xvii) procedures for the control of bird hazards;
- (xviii) procedures for the use and inspection of the aerodrome lighting system, if such a system is provided; and
- (xix) the scale of rescue, first aid and fire service facilities, the aerodrome emergency procedures and procedures to be adopted in the event of temporary depletion of the rescue and fire service facilities.

Status: This is the original version (as it was originally made). This item of legislation is currently only available in its original format.

SCHEDULE 5

Articles 11(4) and 13(2)

AIRCRAFT EQUIPMENT

1. Every aircraft of a description specified in the first column of the Table set forth in paragraph 4 of this Schedule and which is registered in Hong Kong shall be provided, when flying in the circumstances specified in the second column of the said Table, with adequate equipment, and for the purpose of this paragraph the expression 'adequate equipment' shall mean the scales of equipment respectively indicated in that Table:

Provided that, if the aircraft is flying in a combination of such circumstances, the scales of equipment shall not on that account be required to be duplicated.

2. The equipment carried in an aircraft as being necessary for the airworthiness of the aircraft shall be taken into account in determining whether this Schedule is complied with in respect of that aircraft.

3. The following items of equipment shall not be required to be of a type approved by the Governor:

- (a) The equipment referred to in Scale A (ii).
- (b) First aid equipment and handbook, referred to in Scale A.
- (c) Time-pieces, referred to in Scale F.
- (d) Torches, referred to in Scales G, H, K and Z.
- (e) Whistles, referred to in Scale H.
- (f) Sea anchors, referred to in Scales J and K.
- (g) Rocket signals, referred to in Scale J.
- (h) Equipment for mooring, anchoring or manoeuvring aircraft on the water, referred to in Scale J.
- (i) Paddles, referred to in Scale K.
- (j) Food and water, referred to in Scales K, U and V.
- (k) First aid equipment, referred to in Scales K, U and V.
- (l) Stoves, cooking utensils, snow shovels, ice saws, sleeping bags and Arctic suits, referred to in Scale V.
- (m) Megaphones, referred to in Scale Y1 and Y2.

4. Table

<i>Description of Aircraft</i>	<i>Circumstances of Flight</i>	<i>Scale of Equipment Required</i>
(1) Gliders	(a) (a) flying for purposes other than public transport or aerial work: and when flying by night;	A (ii)
	(b) (b) flying for the purpose of public transport or aerial work: and	A, B(i) and (ii), D and F(i)
	(i) when flying by night	C and G

<i>Description of Aircraft</i>	<i>Circumstances of Flight</i>	<i>Scale of Equipment Required</i>
	(ii) when carrying out aerobatic manoeuvres	B (iii)
(2) Aeroplanes	(a) (a) flying for purposes other than public transport; and	A(i) and (ii) and B(i)
	(i) when flying by night	C and D
	(ii) when flying under Instrument Flight Rules	
	(aa) outside controlled airspace	D
	(bb) within controlled airspace	E with E(iv) duplicated and F
	(iii) when carrying out aerobatic manoeuvres	B (iii)
	(b) (b) flying for the purpose of public transport; and	A, B(i) and (ii), D and F(i)
	(i) when flying under Instrument Flight Rules except flights outside controlled airspace by aeroplanes having a maximum total weight authorised not exceeding 1,150 kg.	E with E(iv) duplicated and F
	(ii) when flying by night; and in the case of aeroplanes of which the maximum total weight authorised exceeds 1,150 kg.	C and G, E with E(iv) duplicated and F
	(iii) when flying over water beyond gliding distance from land	H
	(iv) on all flights on which in the event of any emergency occurring during the take-off or during the landing at the intended destination or any likely alternate destination it is reasonably possible that the aeroplane would be forced to land onto water	H
	(v) when flying over water:	H and K

Status: This is the original version (as it was originally made). This item of legislation is currently only available in its original format.

<i>Description of Aircraft</i>	<i>Circumstances of Flight</i>	<i>Scale of Equipment Required</i>
	<p>(aa) in the case of an aeroplane:</p> <p>(aaa) classified in its certificate of airworthiness as being of performance group A, C or X; or</p> <p>(bbb) having no performance group classification in its certificate of airworthiness and of such a weight and performance that with any one of its power units inoperative and the remaining power unit or units operating within the maximum continuous power conditions specified in the certificate of air-worthiness, performance schedule or flight manual relating to the aeroplane issued or rendered valid by the Governor it is capable of a gradient of climb of at least 1 in 200 at an altitude of 5000 ft in the International Standard Atmosphere specified in or ascertainable by reference to</p>	

Status: This is the original version (as it was originally made). This item of legislation is currently only available in its original format.

<i>Description of Aircraft</i>	<i>Circumstances of Flight</i>	<i>Scale of Equipment Required</i>
	the certificate of airworthiness in force in respect of that aircraft, when either more than 400 nautical miles or more than 90 minutes flying time from the nearest aerodrome at which an emergency landing can be made.	
	(bb) in the case of all other aeroplanes, when more than 30 minutes flying time(16) from such an aerodrome.	H and K
	(vi) on all flights which involve manoeuvres on water.	H, J and K
	(vii) when flying at a height of 10,000ft or more above mean sea level:	
	(aa) having a certificate of airworthiness first issued (whether in Hong Kong or elsewhere) before 1 January 1989.	L1 or L2
	(bb) having a certificate of airworthiness first issued (whether in Hong Kong or elsewhere) on or after 1 January 1989.	L2
	(viii) on flights when the weather reports or forecasts available at the aerodrome at the time of departure indicate that conditions favouring ice	M

(16) For the purposes of this Table, flying time shall be calculated on the assumption that the aircraft is flying in still air at the speed specified in the relevant certificate of airworthiness as the speed for compliance with regulations governing flights over water.

Status: This is the original version (as it was originally made). This item of legislation is currently only available in its original format.

<i>Description of Aircraft</i>	<i>Circumstances of Flight</i>	<i>Scale of Equipment Required</i>
	formation are likely to be met.	
	(ix) when carrying out aerobatic manoeuvres.	B(iii)
	(x) on all flights on which the aircraft carries a flight crew of more than one person.	N
	(xi) on all flights for the purpose of the public transport of passengers.	Q and Y2(i), (ii) and (iii)
	(xii) on all flights by a pressurised aircraft.	R2
	(xiii) when flying over substantially uninhabited land areas where, in the event of an emergency landing, tropical conditions are likely to be met.	U
	(xiv) when flying over substantially uninhabited land or other areas where, in the event of any emergency landing, polar conditions are likely to be met.	V
	(vx) when flying at an altitude of more than 49,000 ft.	W
(3) Turbine-jet aero-planes having a maximum total weight authorised exceeding 5,700 kg or pressurised aircraft having a maximum total weight authorised exceeding 11,400 kg.	when flying for the purpose of public transport.	O
(4) Turbine-engined aeroplanes having a maximum total weight authorised exceeding 5,700 kg and piston-engined aeroplanes having a maximum total weight authorised exceeding 27,000 kg		
(a) (a) which are operated by an air transport undertaking under a certificate of	when flying on any flight	P

Status: This is the original version (as it was originally made). This item of legislation is currently only available in its original format.

<i>Description of Aircraft</i>	<i>Circumstances of Flight</i>	<i>Scale of Equipment Required</i>
<p>airworthiness in the Transport Category (Passenger) or the Transport Category (Cargo); or</p>		
<p>(b) (b) in respect of which application has been made and not withdrawn or refused for such a certificate, and which fly under the 'A Conditions' or under a certificate of airworthiness in the Special Category:</p>	<p>when flying on any flight</p>	<p>P</p>
<p>Provided that this paragraph shall not apply to aeroplanes falling within paragraphs (5) or (6) hereof.</p>		
<p>(5) Aeroplanes in respect of which there is in force a certificate of airworthiness in the Transport Category (Passenger) or Transport Category (Cargo) and aeroplanes in respect of which application has been made, and not withdrawn or refused, for such a certificate of airworthiness and which fly under the 'A Conditions' or in respect of which there is in force a certificate of airworthiness in the Special Category:</p>		
<p>(a) (a) which conform to a type first issued with a type certificate (whether in Hong Kong or elsewhere) on or after 1 April 1971 and which have a maximum total weight authorised exceeding 5,700 kg but not exceeding 11,400 kg; or</p>	<p>when flying on any flight</p>	<p>S(i)</p>
<p>(b) (b) which conform to a type</p>	<p>when flying on any flight</p>	<p>S(ii)</p>

Status: This is the original version (as it was originally made). This item of legislation is currently only available in its original format.

<i>Description of Aircraft</i>	<i>Circumstances of Flight</i>	<i>Scale of Equipment Required</i>
<p>first issued with a type certificate (whether in Hong Kong or elsewhere) on or after 1 April 1971 and which have a maximum total weight authorised exceeding 11,400 kg but not exceeding 27,000 kg; or</p> <p>(c) (c) which conform to a type first issued with a type certificate (whether in Hong Kong or elsewhere) on or after 1 April 1971 and which have a maximum total weight authorised exceeding 27,000 kg but not exceeding 230,000 kg; or</p> <p>(d) (d) which conform to a type first issued with a type certificate in Hong Kong on or after 1 January 1970 and which have a maximum total weight authorised exceeding 230,000 kg:</p> <p>Provided that this paragraph shall not apply to aeroplanes falling within paragraph (6) hereof.</p> <p>(6) Aeroplanes in respect of which there is in force a certificate of airworthiness in the Transport Category (Passenger) or Transport Category (Cargo) and aeroplanes in respect of which application has been made, and not withdrawn or refused, for such a certificate of airworthiness and which fly</p>	<p>when flying on any flight</p> <p>when flying on any flight</p>	<p>S(iii)</p> <p>S (iii)</p>

Status: This is the original version (as it was originally made). This item of legislation is currently only available in its original format.

<i>Description of Aircraft</i>	<i>Circumstances of Flight</i>	<i>Scale of Equipment Required</i>
under 'A Conditions' or in respect of which there is in force a certificate of airworthiness in the Special Category:		
(a) (a) for which an individual certificate of airworthiness was first issued (whether in Hong Kong or elsewhere) on or after 1 June 1990 and which have a maximum total weight authorised not exceeding 5,700 kg, are powered by 2 or more turbine engines and are certified to carry more than 9 passengers; or	when flying on any flight	S(iv)
(b) (b) for which an individual certificate of airworthiness was first issued (whether in Hong Kong or elsewhere) on or after 1 June 1990 and which have a maximum total weight authorised exceeding 5,700 kg, but not exceeding 27,000 kg; or	when flying on any flight	S(v)
(c) (c) for which an individual certificate of airworthiness was first issued (whether in Hong Kong or elsewhere) on or after 1 June 1990 and which have a maximum total weight authorised exceeding 27,000 kg	when flying on any flight	S(vi)
(7) Aeroplanes in respect of which there is in force a certificate of airworthiness in the Aerial Work or Private Category and for which an individual certificate of	when flying on any flight	S(vi)

Status: This is the original version (as it was originally made). This item of legislation is currently only available in its original format.

<i>Description of Aircraft</i>	<i>Circumstances of Flight</i>	<i>Scale of Equipment Required</i>
airworthiness was first issued (whether in Hong Kong or elsewhere) on or after 1 June 1990 and which have a maximum total weight authorised exceeding 27,000 kg.		
(8) Aeroplanes:		
(a) (a) which conform to a type first issued with a type certificate (whether in Hong Kong or elsewhere) on or after 1 April 1971 and having a maximum total weight authorised exceeding 27,000 kg and in respect of which there is in force a certificate of airworthiness in the Transport Category (Passenger) or the Transport Category (Cargo); or	when flying on any flight	T
(b) (b) which conform to a type first issued with a type certificate in Hong Kong on or after 1 January 1970 and which have a maximum total weight authorised exceeding 230,000 kg and in respect of which there is in force such a certificate of airworthiness; or	when flying on any flight	T
(c) (c) having a maximum total weight authorised exceeding 27,000 kg which conform to a type first issued with a type certificate on or after 1 April 1971 (or 1 January 1970 in the case of	when flying on any flight	T

<i>Description of Aircraft</i>	<i>Circumstances of Flight</i>	<i>Scale of Equipment Required</i>
<p>an aeroplane having a maximum total weight authorised exceeding 230,000 kg) in respect of which an application has been made, and not withdrawn or refused for such a certificate of airworthiness and which fly under the 'A Conditions' or in respect of which there is in force a certificate of airworthiness in the Special Category.</p>		
<p>(9) Aeroplanes which have a maximum total weight authorised exceeding 15,000 kg or which in accordance with the certificate of airworthiness in force in respect thereof may carry more than 30 passengers.</p>	<p>on all flights for the purpose of public transport.</p>	<p>X</p>
<p>(10) Aeroplanes:</p>		
<p>(a) (a) which are turbo-jets and which have a maximum total weight authorised exceeding 22,700 kg; or</p>	<p>when flying by night for the purpose of the public transport of passengers.</p>	<p>Z(i) and (ii)</p>
<p>(b) (b) having a maximum total weight authorised exceeding 5,700 kg and which conform to a type for which a certificate of airworthiness was first applied for (whether in Hong Kong or elsewhere) after 30 April 1972 but not including any aeroplane which in the opinion of the Governor is identical in all matters affecting the provision of</p>	<p>when flying by night for the purpose of the public transport of passengers</p>	<p>Z(i) and (ii)</p>

Status: This is the original version (as it was originally made). This item of legislation is currently only available in its original format.

<i>Description of Aircraft</i>	<i>Circumstances of Flight</i>	<i>Scale of Equipment Required</i>
emergency evacuation facilities to an aeroplane for which a certificate of airworthiness was first applied for before that date; or		
(c) (c) which in accordance with the certificate of airworthiness in force in respect thereof may carry more than 19 passengers; or	when flying by night for the purpose of the public transport of passengers	Z(i)
(d) (d) having a maximum total weight authorised exceeding 5,700 kg and which conform to a type for which a certificate of airworthiness was first applied for (whether in Hong Kong or elsewhere) after 30 April 1972 but not including any aeroplane which in the opinion of the Governor is identical in all matters affecting the provision of emergency evacuation facilities to an aeroplane for which a certificate of airworthiness was first applied for before that date; or	when flying for the purpose of the public transport of passengers	Z(iii)
(e) (e) which are turbo-jets and which have a maximum total weight authorised exceeding 22,700 kg; or	when flying for the purpose of the public transport of passengers	Z(iii)
(f) (f) first issued with a type certificate (whether in Hong Kong or elsewhere)	when flying for the purpose of the public transport of passengers.	Z(iii)

<i>Description of Aircraft</i>	<i>Circumstances of Flight</i>	<i>Scale of Equipment Required</i>
on or after 1 January 1958 and which in accordance with the certificate of airworthiness in force in respect thereof may carry more than 19 passengers.		
(11) Aeroplanes:		
(a) (a) powered by one or more turbine jets and first issued with a certificate of airworthiness in Hong Kong on or after 1 April 1989;	when flying on any flight	AA
(b) (b) powered by one or more turbine jets and first issued with a certificate of airworthiness in Hong Kong prior to 1 April 1989;	when flying on any flight	AA
(c) (c) powered by one or more turbine propeller engines and having a maximum total weight authorised exceeding 5,700 kg and first issued with a certificate of airworthiness in Hong Kong on or after 1 April 1989.	when flying on any flight	AA
(12) Aeroplanes:		
(a) (a) which conform to a type first issued with a type certificate (whether in Hong Kong or elsewhere) on or after 1 April 1978 and in respect of which there is in force a certificate of airworthiness in the Transport Category (Passenger);	on all flights for the purpose of the public transport of passengers	Y2 (iv)

Status: This is the original version (as it was originally made). This item of legislation is currently only available in its original format.

<i>Description of Aircraft</i>	<i>Circumstances of Flight</i>	<i>Scale of Equipment Required</i>
(b) (b) which conform to a type first issued with a type certificate (whether in Hong Kong or elsewhere) on or after 1 April 1968 and before 1 April 1978 and in respect of which there is in force a certificate of airworthiness in the Transport Category (Passenger);	on all flights for the purpose of the public transport of passengers	Y2 (iv)
(c) (c) which conform to a type first issued with a type certificate (whether in Hong Kong or elsewhere) before 1 April 1968 and in respect of which there is in force a certificate of airworthiness in the Transport Category (Passenger).	on all flights for the purpose of the public transport of passengers	Y2 (iv)
(13) Helicopters and Gyroplanes	(a) (a) flying for purposes other than public transport: and (i) when flying by day under Visual Flight Rules with visual ground reference (ii) when flying by day under Instrument Flight Rules or without visual ground reference (aa) outside controlled airspace (bb) within controlled airspace (iii) when flying by night (aa) with visual ground reference (bb) without visual ground reference	A(i) and (ii) and B(i) D E with E(ii) duplicated E with E(ii) and E(iv) duplicated and F with F(iv) for all weights C, E, G(iii) and G(v)

Status: This is the original version (as it was originally made). This item of legislation is currently only available in its original format.

<i>Description of Aircraft</i>	<i>Circumstances of Flight</i>	<i>Scale of Equipment Required</i>
	(aaa) outside controlled airspace	C, E with E(ii) duplicated, G(iii) and G(v)
	(bbb) within controlled airspace	C, E with both E(ii) and E(iv) duplicated, F with F(iv) for all weights, G(iii) and G(v)
	(b) (b) flying for the purpose of public transport; and	A, B(i) and (ii), F(i) and F(iv) for all weights
	(i) when flying by day under Visual Flight Rules with visual ground reference	D
	(ii) when flying by day under Instrument Flight Rules or without visual ground reference	E with both E(ii) and E(iv) duplicated, F(ii), F(iii) and F(v)
	(iii) when flying by night with visual ground reference	
	(aa) in the case of a helicopter or gyroplane having a maximum total weight authorised not exceeding 2,000 kg	C, E and G
	(bb) in the case of a helicopter or gyroplane having a maximum total weight authorised exceeding 2,000 kg	C, E with E(ii) duplicated and either E(iv) duplicated or a radio altimeter, F(ii), F(iii), F(v) and G
	(iv) when flying by night without visual ground reference	C, E with both E(ii) and E(iv) duplicated, F(ii), F(iii), F(v) and G
	(v) when flying over water	E and H
	(aa) in the case of a helicopter or gyroplane classified in its certificate of airworthiness as being of performance group A2 or B when beyond auto-rotational gliding distance from land	

Status: This is the original version (as it was originally made). This item of legislation is currently only available in its original format.

<i>Description of Aircraft</i>	<i>Circumstances of Flight</i>	<i>Scale of Equipment Required</i>
	suitable for an emergency landing	
	(bb) on all flights on which in the event of any emergency occurring during the take-off or during the landing at the intended destination or any likely alternate destination it is reasonably possible that the helicopter or gyroplane would be forced to land onto water	H
	(cc) in the case of a helicopter or gyroplane classified in its certificate of airworthiness as being of performance group A2 when beyond 10 minutes flying time(17) from land	E, H, K and T
	(dd) for more than a total of 3 minutes in any flight	EE
	(ee) in the case of a helicopter or gyroplane classified in its certificate of airworthiness as being of performance group A2 which is intended to fly beyond 10 minutes flying time from land, on a flight in support of or in connection with the offshore exploitation, or exploration of mineral resources (including gas) when the weather report or	I

(17) For the purposes of this Table, flying time shall be calculated on the assumption that the aircraft is flying in still air at the speed specified in the relevant certificate of airworthiness as the speed for compliance with regulations governing flights over water.

Status: This is the original version (as it was originally made). This item of legislation is currently only available in its original format.

<i>Description of Aircraft</i>	<i>Circumstances of Flight</i>	<i>Scale of Equipment Required</i>
	forecasts available to the commander of the aircraft indicate that the sea temperature will be less than plus 10°C during the flight or when any part of the flight is at night	
	(vi) on all flights which involve manoeuvres on water	H, J and K
	(vii) when flying at a height of 10 000ft or more above mean sea level:	L1 or L2
	(aa) having a certificate of airworthiness first issued (whether in Hong Kong or elsewhere) before 1 January 1989	
	(bb) having a certificate of airworthiness first issued (whether in Hong Kong or elsewhere) on or after 1 January 1989	L2
	(viii) on flights when the weather reports or forecasts available at the aerodrome at the time of departure indicate that conditions favouring ice formation are likely to be met	M
	(ix) on all flights on which the aircraft carries a flight crew of more than one person	N
	(x) on all flights for the purpose of the public transport of passengers	Y2(i), (ii) and (iii)
	(xi) when flying over substantially uninhabited land areas where, in the event of an emergency	U

Status: This is the original version (as it was originally made). This item of legislation is currently only available in its original format.

<i>Description of Aircraft</i>	<i>Circumstances of Flight</i>	<i>Scale of Equipment Required</i>
	landing, tropical conditions are likely to be met	
	(xii) when flying over substantially uninhabited land or other areas where, in the event of any emergency landing, polar conditions are likely to be met	V
(14) Helicopters & Gyroplanes		
(a) (a) having a maximum total weight authorised exceeding 5,700 kg and which conform to a type for which a certificate of airworthiness was first applied for (whether in Hong Kong or elsewhere) after 30 April 1972 but not including any helicopter or gyroplane which in the opinion of the Governor is identical in all matters affecting the provision of emergency evacuation facilities to a helicopter or gyroplane for which a certificate of airworthiness was first applied for before that date; or	when flying by night for the purpose of the public transport of passengers	Z(i) and (ii)
(b) (b) which, in accordance with the certificate of airworthiness in force in respect thereof may carry more than 19 passengers; or	when flying by night for the purpose of the public transport of passengers	Z(i)
(c) (c) which have a certificate of	when flying on any flight	S(vii)

Status: This is the original version (as it was originally made). This item of legislation is currently only available in its original format.

<i>Description of Aircraft</i>	<i>Circumstances of Flight</i>	<i>Scale of Equipment Required</i>
<p>airworthiness issued in the Transport Category (Passenger or Cargo) and which have either a maximum total weight authorised exceeding 2,730 kg or which may carry more than 9 passengers; or</p> <p>(d) (d) which have a certificate of airworthiness issued in the Transport Category (Passenger or Cargo) and helicopters and gyroplanes in respect of which application has been made and not withdrawn or refused for such a certificate of airworthiness and which fly under the “A Conditions” or which have a certificate of airworthiness in the Special Category and</p>		
<p>(i) which have a maximum total weight authorised exceeding 2,730 kg but not exceeding 7,000 kg or which in accordance with the certificate of airworthiness in force in respect thereof may carry more than 9 passengers, or both</p>	when flying on any flight	SS(i) or (iii)
<p>(ii) which have a maximum total weight authorised exceeding 7,000 kg</p>	when flying on any flight	SS(ii) or (iii)

5. The scales of equipment indicated in the foregoing Table shall be as follows:

Scale A

Status: This is the original version (as it was originally made). This item of legislation is currently only available in its original format.

- (i) Spare fuses for all electrical circuits the fuses of which can be replaced in flight, consisting of 10 per cent of the number of each rating or three of each rating, whichever is the greater.
- (ii) Maps, charts, codes and other documents and navigational equipment necessary, in addition to any other equipment required under this Order, for the intended flight of the aircraft including any diversion which may reasonably be expected.
- (iii) First aid equipment of good quality, sufficient in quantity, having regard to the number of persons on board the aircraft, and including the following:
 - Roller bandages, triangular bandages, adhesive plaster, absorbent gauze, cotton wool (or wound dressings in place of the absorbent gauze and cotton wool), burn dressings, safety pins;
 - Haemostatic bandages or tourniquets, scissors;
 - Antiseptic, analgesic and stimulant drugs;
 - Splints, in the case of aeroplanes the maximum total weight authorised of which exceeds 5,700 kg;
 - A handbook on first aid.
- (iv) In the case of a flying machine used for the public transport of passengers in which, while the flying machine is at rest on the ground, the sill of any external door intended for the disembarkation of passengers, whether normally or in an emergency:
 - (a) is more than 1.82 metres from the ground when the undercarriage of the machine is in the normal position for taxiing; or
 - (b) would be more than 1.82 metres from the ground if the undercarriage or any part thereof should collapse, break or fail to function;apparatus readily available for use at each door consisting of a device or devices which will enable passengers to reach the ground safely in an emergency while the flying machine is on the ground, and can be readily fixed in position for use.

Scale AA

An altitude alerting system capable of alerting the pilot upon approaching a preselected altitude in either ascent or descent, by a sequence of visual and aural signals in sufficient time to establish level flight at that preselected altitude, and when deviating above or below that preselected altitude, by a visual and an aural signal:

Provided that if the system becomes unserviceable, the aircraft may fly or continue to fly, until it first lands at a place at which it is reasonably practicable for the system to be repaired or replaced.

Scale B

- (i) (a) If the maximum total weight authorised of the aircraft is 2,730 kg or less, for every pilot's seat and for any seat situated alongside a pilot's seat, a safety belt with one diagonal shoulder strap or a safety harness:
 - Provided that the Governor may permit a safety belt without a diagonal shoulder strap to be fitted if he is satisfied that it is not reasonably practicable to fit a safety belt with one diagonal shoulder strap or a safety harness.
- (b) If the maximum total weight authorised of the aircraft exceeds 2,730 kg, a safety harness for every pilot's seat and for any seat situated alongside a pilot's seat, in place of the safety belt with one diagonal shoulder strap referred to under subparagraph (a):

Status: This is the original version (as it was originally made). This item of legislation is currently only available in its original format.

Provided that the Governor may permit a safety belt with one diagonal shoulder strap to be fitted if he is satisfied that it is not reasonably practicable to fit a safety harness.

- (c) For every seat in use (not being a seat referred to in sub-paragraphs (a), (b), (e) and (f)) a safety belt with or without one diagonal shoulder strap or a safety harness.
- (d) In addition and to be attached to or secured by the equipment required in sub-paragraph (c) above, a child restraint device for every child under the age of 2 years on board.
- (e) On all flights for the public transport of passengers by aircraft, for each seat for use by cabin attendants who are required to be carried under this Order, a safety harness.
- (f) On all flights in aeroplanes the maximum total weight authorised of which does not exceed 5,700 kg which in accordance with the certificate of airworthiness in force thereof is not capable of seating more than 9 passengers (otherwise than in seats referred to under sub-paragraphs (a) and (b)), a safety belt with one diagonal shoulder strap or a safety harness for each seat intended for use by a passenger:

Provided that the provisions of this sub-paragraph shall not apply to aeroplanes in respect of which a certificate of airworthiness was first issued (whether in Hong Kong or elsewhere) before 1 February 1989.

- (ii) If the commander cannot, from his own seat, see all the passengers' seats in the aircraft, a means of indicating to the passengers that seat belts should be fastened.
- (iii) A safety harness for every seat in use:

Provided that in the case of an aircraft carrying out aerobatic manoeuvres consisting only of erect spinning, the Governor may permit a safety belt with one diagonal shoulder strap to be fitted if he is satisfied that such restraint is sufficient for the carrying out of erect spinning in that aircraft and that it is not reasonably practicable to fit a safety harness in that aircraft.

Scale C

- (i) Equipment for displaying the lights required by the Rules of the Air;
- (ii) Electrical equipment, supplied from the main source of supply in the aircraft, to provide sufficient illumination to enable the flight crew properly to carry out their duties during flight;
- (iii) Unless the aircraft is equipped with radio, devices for making the visual signal specified in the Rules of the Air as indicating a request for permission to land.

Scale D

- (i) (a) In the case of a helicopter or gyroplane, a slip indicator;
- (b) In the case of any other flying machine either:
 - (aa) a turn indicator and a slip indicator; or
 - (bb) a gyroscopic bank and pitch indicator and a gyroscopic direction indicator;
- (ii) A sensitive pressure altimeter adjustable for any sea level barometric pressure which the weather report or forecasts available to the commander of the aircraft indicate is likely to be encountered during the intended flight.

Scale E

- (i) (a) In the case of a helicopter or gyroplane, a slip indicator;
- (b) In the case of any other flying machine, a turn indicator and a slip indicator;

Status: This is the original version (as it was originally made). This item of legislation is currently only available in its original format.

- (ii) A gyroscopic bank and pitch indicator;
- (iii) A gyroscopic direction indicator;
- (iv) A sensitive pressure altimeter adjustable for any sea level barometric pressure which the weather report or forecasts available to the commander of the aircraft indicate is likely to be encountered during the intended flight:

Provided that any aircraft may, at the option of the operator, be equipped with an additional gyroscopic bank and pitch indicator in lieu of the turn indicator referred to in (i) of this Scale.

Scale EE

A radio altimeter with an audio voice warning operating below a preset height and a visual warning capable of operating at a height selectable by the pilot.

Scale F

- (i) A timepiece indicating the time in hours, minutes and seconds;
- (ii) A means of indicating whether the power supply to the gyroscopic instrument is adequate;
- (iii) A rate of climb and descent indicator;
- (iv) If the maximum total weight authorised of the aircraft exceeds 5,700 kg a means of indicating outside air temperature;
- (v) If the maximum total weight authorised of the aircraft exceeds 5,700 kg two air speed indicators.

Scale G

- (i) In the case of an aircraft other than a helicopter or gyroplane landing lights consisting of two single filament lamps, or one dual filament lamp with separately energised filaments;
- (ii) An electrical lighting system to provide illumination in every passenger compartment;
- (iii) (a) One electric torch for each member of the crew of the aircraft; or
 - (b) (aa) one electric torch for each member of the flight crew of the aircraft; and
 - (bb) at least one electric torch affixed adjacent to each floor level exit intended for the disembarkation of passengers whether normally or in an emergency, provided that such torches shall;
 - (aaa) be readily accessible for use by the crew of the aircraft at all times; and
 - (bbb) number in total not less than the minimum number of cabin attendants required to be carried with a full passenger complement;
- (iv) In the case of an aircraft other than a helicopter or gyroplane of which the maximum total weight authorised exceeds 5,700 kg, means of observing the existence and build up of ice on the aircraft;
- (v) (a) In the case of a helicopter or gyroplane in respect of which there is in force a certificate of airworthiness designating the helicopter or gyroplane as being of performance group A, either:
 - (aa) two landing lights both of which are adjustable so as to illuminate the ground in front of and below the helicopter or gyroplane and one of which is adjustable so as to illuminate the ground on either side of the helicopter or gyroplane; or
 - (bb) one landing light or, if the maximum total weight authorised of the helicopter or gyroplane exceeds 5,700 kg, one dual filament landing light with separately energised filaments, or two single filament lights, each of which is

Status: This is the original version (as it was originally made). This item of legislation is currently only available in its original format.

adjustable so as to illuminate the ground in front of and below the helicopter or gyroplane, and two parachute flares;

- (b) In the case of a helicopter or gyroplane in respect of which there is in force a certificate of airworthiness designating the helicopter or gyroplane as being of performance group B, either:
 - (aa) one landing light and 2 parachute flares; or
 - (bb) if the maximum total weight authorised of the helicopter or gyroplane exceeds 5,700 kg, either one dual filament landing light with separately energised filaments or 2 single filament landing lights, and 2 parachute flares.

Scale H

For each person on board, a lifejacket equipped with a whistle and waterproof torch:

Provided that lifejackets constructed and carried solely for use by children under three years of age need not be equipped with a whistle.

Scale I

A survival suit for each member of the crew.

Scale J

- (i) Additional flotation equipment, capable of supporting one-fifth of the number of persons on board, and provided in a place of stowage accessible from outside the flying machine;
- (ii) Parachute distress rocket signals capable of making, from the surface of the water, the pyrotechnical signal of distress specified in the Rules of the Air and complying with Part I of Schedule 8 to the Merchant Shipping (Safety) (Life-Saving Appliances) (Ships Built on or after 1 July 1986) Regulations 1991; made under the Merchant Shipping (Safety) Ordinance (Cap 369);
- (iii) A sea anchor and other equipment necessary to facilitate mooring, anchoring or manoeuvring the flying machine on water, appropriate to its size, weight and handling characteristics.

Scale K

- (i) (a) In the case of a flying machine, other than a helicopter or gyroplane carrying 20 or more persons, liferafts sufficient to accommodate all persons on board;
- (b) In the case of a helicopter or gyroplane carrying 20 or more persons, a minimum of 2 liferafts sufficient together to accommodate all persons on board.

Each liferaft shall contain the following equipment:

- (a) means for maintaining buoyancy;
- (b) a sea anchor;
- (c) life-lines, and means of attaching one liferaft to another;
- (d) paddles or other means of propulsion;
- (e) means of protecting the occupants from the elements;
- (f) a waterproof torch;
- (g) marine type pyrotechnical distress signals;
- (h) means of making sea water drinkable, unless the full quantity of fresh water is carried as specified in sub-paragraph (i);
- (i) for each 4 or proportion of 4 persons the liferaft is designed to carry:
 - 100 grammes of glucose toffee tablets;
 - ½ litre of fresh water in durable containers;

Status: This is the original version (as it was originally made). This item of legislation is currently only available in its original format.

Provided that in any case in which it is not reasonably practicable to carry the quantity of water above specified as large a quantity of fresh water as is reasonably practicable in the circumstances may be substituted. In no case however shall the quantity of water carried be less than is sufficient, when added to the amount of fresh water capable of being produced by means of the equipment specified in subparagraph (h) to provide ½ litre of water for each 4 or proportion of 4 persons the liferaft is designed to carry.

(j) first aid equipment;

Items (f) to (j) inclusive shall be contained in a pack.

(ii) The number of survival beacon radio apparatus carried when the aircraft is carrying the number of liferafts specified in column 1 of the following Table shall be not less than the number specified in, or calculated in accordance with column 2.

TABLE

<i>Column 1</i>	<i>Column 2</i>
Not more than 8 liferafts.	2 survival beacon radio apparatus.
For every additional 4 or proportion of 4 liferafts.	1 additional survival beacon radio apparatus.

(iii) In the case of a helicopter or gyroplane, an emergency beacon which is automatically deployed and activated in the event of a crash.

Scale LI

Part 1

(i) In every flying machine which is provided with means for maintaining a pressure greater than 700 millibars throughout the flight in the flight crew compartment and in the compartments in which the passengers are carried:

(a) a supply of oxygen sufficient, in the event of failure to maintain such pressure, occurring in the circumstances specified in columns 1 and 2 of the Table set out in Part II of this Scale, for continuous use, during the periods specified in column 3 of the said Table, by the persons for whom oxygen is to be provided in accordance with column 4 of that Table; and

(b) in addition, in every case where the flying machine flies above flight level 350, a supply of oxygen in a portable container sufficient for the simultaneous first aid treatment of 2 passengers,

together with suitable and sufficient apparatus to enable such persons to use the oxygen.

(ii) In any other flying machine:

(a) a supply of oxygen sufficient for continuous use by all the crew other than the flight crew, and if passengers are carried, by 10% of the number of passengers, for any period exceeding 30 minutes during which the flying machine flies above flight level 100 but not above flight level 130 and the flight crew shall be supplied with oxygen sufficient for continuous use for any period during which the flying machine flies above flight level 100; and

(b) a supply of oxygen sufficient for continuous use by all persons on board for the whole time during which the flying machine flies above flight level 130, together with suitable and sufficient apparatus to enable such persons to use the oxygen.

Status: This is the original version (as it was originally made). This item of legislation is currently only available in its original format.

- (iii) The quantity of oxygen required for the purpose of complying with paragraphs (i) and (ii) of this Part of this Scale shall be computed in accordance with the information and instructions relating thereto specified in the operations manual relating to the aircraft pursuant to Item (vi) of Part A of Schedule 11 to this Order.

Part II

<i>Column 1</i> <i>Vertical displacement of the flying machine in relation to flight levels</i>	<i>Column 2</i> <i>Capability of flying machine to descend (where relevant)</i>	<i>Column 3</i> <i>Period of supply of oxygen</i>	<i>Column 4</i> <i>Persons for whom oxygen is to be provided</i>
Above flight level 100	—	30 minutes or the period specified at A hereunder whichever is the greater	In addition to any passengers for whom oxygen is provided as specified below, all the crew
	{ Flying machine is either flying at or below flight level 150 or is capable of descending and continuing to destination as specified at X hereunder	30 minutes or the period specified at A hereunder whichever is the greater	10 per cent of number of passengers
Above flight level 100 but not above flight level 300	Flying machine is flying above flight level 150 and is not so capable	{ 10 minutes or the period specified at B hereunder whichever is the greater and in addition { 30 minutes or the period specified at C hereunder whichever is the greater	All passengers 10 per cent of number of passengers
Above flight level 300 but not above flight level 350	{ Flying machine is capable of descending and continuing to destination as specified at Y hereunder	30 minutes or the period specified at A hereunder whichever is the greater	15 per cent of number of passengers
	{ Flying machine is not so capable	{ 10 minutes or the period specified at B hereunder	All passengers

Status: This is the original version (as it was originally made). This item of legislation is currently only available in its original format.

<i>Column 1</i>	<i>Column 2</i>	<i>Column 3</i>	<i>Column 4</i>
<i>Vertical displacement of the flying machine in relation to flight levels</i>	<i>Capability of flying machine to descend (where relevant)</i>	<i>Period of supply of oxygen</i>	<i>Persons for whom oxygen is to be provided</i>
		whichever is the greater	
			and in addition
		{ 30 minutes or the period specified at C hereunder whichever is the greater	15 per cent of number of passengers
		{ 10 minutes or the period specified at B hereunder whichever is the greater	All passengers
Above flight level 350	—		and in addition
		{ 30 minutes or the period specified at C hereunder whichever is the greater	15 per cent of number of passengers
A	The whole period during which, after a failure to maintain a pressure greater than 700 millibars in the control compartment and in the compartments in which passengers are carried has occurred, the flying machine flies above flight level 100.		
B	The whole period during which, after a failure to maintain such pressure has occurred, the flying machine flies above flight level 150.		
C	The whole period during which, after a failure to maintain such pressure has occurred, the flying machine flies above flight level 100, but not above flight level 150.		
X	The flying machine is capable, at the time when a failure to maintain such pressure occurs, of descending in accordance with the emergency descent procedure specified in the relevant flight manual and without flying below the minimum altitudes for safe flight specified in the operations manual relating to the aircraft, to flight level 150 within 6 minutes, and of continuing at or below that flight level to its place of intended destination or any other place at which a safe landing can be made.		
Y	The flying machine is capable, at the time when a failure to maintain such pressure occurs, of descending in accordance with the emergency descent procedure specified in the relevant flight manual and without flying below the minimum altitudes for safe flight specified in the operations manual relating to the aircraft, to flight level 150 within 4 minutes, and of continuing at or below that flight level to its place of intended destination or any other place at which a safe landing can be made.		

Scale L2

A supply of oxygen and the associated equipment to meet the requirements set out in Parts I and II of this scale. The duration for the purposes of this scale shall be:

- (i) that calculated in accordance with the operations manual prior to the commencement of the flight, being the period or periods which it is reasonably anticipated that the aircraft

Status: This is the original version (as it was originally made). This item of legislation is currently only available in its original format.

will be flown in the circumstances of the intended flight at a height where the said requirements apply and in calculating the said duration account shall be taken of:

- (a) in the case of pressurised aircraft, the possibility of depressurisation when flying above flight level 100;
 - (b) the possibility of failure of one or more of the aircraft engines;
 - (c) restrictions due to required minimum safe altitude;
 - (d) fuel requirement; and
 - (e) the performance of the aircraft; or
- (ii) the period or periods during which the aircraft is actually flown in the circumstances specified in the said Parts;

whichever is the greater.

Part I

Unpressurised aircraft

- (i) When flying at or below flight level 100:

Nil

- (ii) When flying above flight level 100 but not exceeding flight level 120:

<i>Supply for</i>	<i>Duration</i>
(a) (a) Members of the flight crew	Any period during which the aircraft flies above flight level 100.
(b) (b) Cabin attendants and 10 per cent of passengers	For any continuous period exceeding 30 minutes during which the aircraft flies above flight level 100 but not exceeding flight level 120, the duration shall be the period by which 30 minutes is exceeded.

- (iii) When flying above flight level 120:

<i>Supply for</i>	<i>Duration</i>
(a) (a) Members of the flight crew	Any period during which the aircraft flies above flight level 120.
(b) (b) Cabin attendants and all passengers	Any period during which the aircraft flies above flight level 120.

Part II

Pressurised aircraft

- (i) When flying at or below flight level 100:

Nil

- (ii) When flying above flight level 100 but not exceeding flight level 250:

<i>Supply for</i>	<i>Duration</i>
(a) (a) Members of the flight crew	30 minutes or whenever the cabin pressure altitude exceeds 10,000 ft, whichever is the greater

Status: This is the original version (as it was originally made). This item of legislation is currently only available in its original format.

<i>Supply for</i>	<i>Duration</i>
(b) (b) Cabin attendants and 10 per cent of passengers	(aa) When the aircraft is capable of descending and continuing to its destination as specified at A hereunder, 30 minutes or whenever the cabin pressure altitude exceeds 10,000 ft, whichever is the greater (bb) When the aircraft is not so capable, whenever the cabin pressure altitude is greater than 10,000 ft, but does not exceed 12,000 ft
(c) (c) Cabin attendants and passengers	(aa) When the aircraft is capable of descending and continuing to its destination as specified at A hereunder, no requirement other than that at (ii) (b) (aa) of this part of this scale (bb) When the aircraft is not so capable and the cabin pressure altitude exceeds 12,000 ft, the duration shall be the period when the cabin pressure altitude exceeds 12,000 ft or 10 minutes, whichever is the greater

(iii) When flying above flight level 250:

<i>Supply for</i>	<i>Duration</i>
(a) (a) Members of the flight crew	2 hours or whenever the cabin pressure altitude exceeds 10,000 ft, whichever is the greater
(b) (b) Cabin attendants	Whenever the cabin pressure altitude exceeds 10,000 ft, and a portable supply for 15 minutes
(c) (c) 10 per cent of passengers	Whenever the cabin pressure altitude exceeds 10,000 ft but does not exceed 12,000 ft
(d) (d) 30 per cent of passengers	Whenever the cabin pressure altitude exceeds 12,000 ft but does not exceed 15,000 ft

A The flying machine is capable, at the time when a failure to maintain cabin pressurisation occurs of descending in accordance with the emergency descent procedure specified in the relevant flight manual and without flying below the minimum altitudes for safe flight specified in the operations manual relating to the aircraft, to flight level 120 within 5 minutes and of continuing at or below that flight level to its place of intended destination or any other place at which a safe landing can be made.

Status: This is the original version (as it was originally made). This item of legislation is currently only available in its original format.

<i>Supply for</i>	<i>Duration</i>
(e) (e) All passengers	If the cabin pressure altitude exceeds 15,000 ft, the duration shall be the period when the cabin pressure altitude exceeds 15,000 ft or 10 minutes, whichever is the greater
(f) (f) 2 per cent of passengers or 2 passengers, whichever is the greater, being a supply of first aid oxygen which must be available for simultaneous first aid treatment of 2 per cent or 2 passengers wherever they are seated in the aircraft	Whenever, after decompression, the cabin pressure altitude exceeds 8,000 ft
A	The flying machine is capable, at the time when a failure to maintain cabin pressurisation occurs of descending in accordance with the emergency descent procedure specified in the relevant flight manual and without flying below the minimum altitudes for safe flight specified in the operations manual relating to the aircraft, to flight level 120 within 5 minutes and of continuing at or below that flight level to its place of intended destination or any other place at which a safe landing can be made.

Scale M

Equipment to prevent the impairment through ice formation of the functioning of the controls, means of propulsion, lifting surfaces, windows or equipment of the aircraft so as to endanger the safety of the aircraft.

Scale N

An intercommunication system for use by all members of the flight crew and including microphones, not of a hand-held type, for use by the pilot and flight engineer (if any).

Scale O

A radar set capable of giving warning to the pilot in command of the aircraft and to the co-pilot of the presence of cumulo-nimbus clouds and other potentially hazardous weather conditions: Provided that a flight may commence if the set is unserviceable or continue if the set becomes unserviceable thereafter:

- (a) so as to give the warning only to one pilot, so long as the aircraft is flying only to the place at which it first becomes reasonably practicable for the set to be repaired; or
- (b) when the weather report or forecasts available to the commander of the aircraft indicate that cumulo-nimbus clouds or other potentially hazardous weather conditions, which can be detected by the set when in working order, are unlikely to be encountered on the intended route or any planned diversion therefrom or the commander has satisfied himself that any such weather conditions will be encountered in daylight and can be seen and avoided, and the aircraft is in either case operated throughout the flight in accordance with any relevant instructions given in the operations manual.

Scale P

A flight data recorder which is capable of recording, by reference to a time-scale, the following data:

- (a) indicated airspeed;
- (b) indicated altitude;

Status: This is the original version (as it was originally made). This item of legislation is currently only available in its original format.

- (c) vertical acceleration;
- (d) magnetic heading;
- (e) pitch attitude, if the equipment provided in the aeroplane is of such a nature as to enable this item to be recorded;
- (f) engine power, if the equipment provided in the aeroplane is of such a nature as to enable this item to be recorded;
- (g) flap position;
- (h) roll attitude, if the equipment provided in the aeroplane is of such a nature as to enable this item to be recorded:

Provided that any aeroplane having a maximum total weight authorised not exceeding 11,400 kg may be provided with:

- (i) a flight data recorder capable of recording the data described in sub-paragraphs (a) to (h) of this Scale; or
- (ii) a 4 channel cockpit voice recorder.

In addition, on all flights by turbine-powered aeroplanes having a maximum total weight authorised exceeding 11,400 kg, a 4 channel cockpit voice recorder.

The flight data recorder and cockpit voice recorder referred to above shall be so constructed that the record would be likely to be preserved in the event of an accident to the aeroplane:

Provided that an aeroplane shall not be required to carry the said equipment, if before take-off the equipment is found to be unserviceable and the aircraft flies in accordance with arrangements approved by the Governor.

Scale Q

If the maximum total weight authorised of the aeroplane exceeds 5,700 kg and it was first registered, whether in Hong Kong or elsewhere, on or after 1 June 1965, a door between the flight crew compartment and any adjacent compartment to which passengers have access, which door shall be fitted with a lock or bolt capable of being worked from the flight crew compartment.

Scale R1

- (i) Equipment sufficient to protect the eyes, nose and mouth of the pilot in command of the aircraft from the effects of smoke and noxious gases for a period of not less than 15 minutes;
- (ii) Portable equipment sufficient to protect the eyes, nose and mouth of one other member of the crew of the aircraft from the effects of smoke and noxious gases for a period of not less than 8 minutes; and
- (iii) Equipment sufficient to protect from the effects of smoke and noxious gases the eyes of all members of the flight crew of the aircraft whose eyes are not adequately protected by other equipment.

Scale R2

- (i) (a) In respect of aeroplanes having a maximum total weight authorised exceeding 5,700 kg, equipment sufficient to protect the eyes, nose and mouth of all members of the flight crew required to be carried by virtue of Article 18 of this Order for a period of not less than 15 minutes and, in addition, where the minimum flight crew required as aforesaid is more than one and a cabin attendant is not required to be carried by virtue of Article 18 of this Order, portable equipment sufficient to protect the eyes, nose and mouth of one member of the flight crew for a period of not less than 15 minutes;

Status: This is the original version (as it was originally made). This item of legislation is currently only available in its original format.

- (b) In respect of aeroplanes having a maximum total weight authorised not exceeding 5,700 kg, the equipment specified in (i)(a) of this Scale:

Provided that in the case of such aeroplanes restricted by virtue of the operator's operations manual to flight at or below flight level 250 and capable of descending as specified at A hereunder such equipment shall be sufficient to protect the eyes only.

- (ii) (a) In respect of aeroplanes having a maximum total weight authorised exceeding 5,700 kg, portable equipment to protect the eyes, nose and mouth of all cabin attendants required to be carried by virtue of Article 18 of this Order for a period of not less than 15 minutes;
- (b) In respect of aeroplanes having a maximum total weight authorised not exceeding 5,700 kg, the equipment specified in (ii)(a) of this Scale:

Provided that this requirement shall not apply to such aeroplanes restricted by virtue of the operator's operations manual to flight at or below flight level 250 and capable of descending as specified at A hereunder.

- A The aeroplane is capable of descending in accordance with the emergency descent procedure specified in the relevant flight manual and without flying below the minimum altitudes for safe flight specified in the operations manual relating to the aeroplane, to flight level 100 within 4 minutes and of continuing at or below that flight level to its place of intended destination or any other place at which a safe landing can be made.

Scale S

A flight recording system comprising:

- (i) either a 4 channel cockpit voice recorder or a flight data recorder capable of recording by reference to a time scale the data required to determine the following matters accurately in respect of the aeroplane: the flight path, altitude and the basic lift, thrust and drag forces acting upon it;
- (ii) a 4 channel cockpit voice recorder and a flight data recorder capable of recording by reference to a time scale the data required to determine the following matters accurately in respect of the aeroplane; the information specified in paragraph (i) of this Scale together with use of VHF transmitters;
- (iii) a 4 channel cockpit voice recorder and a flight data recorder capable of recording by reference to a time scale the data required to determine the following matters accurately in respect of the aeroplane: the flight path, attitude, the basic lift, thrust and drag forces acting upon it, the selection of high lift devices (if any) and airbrakes (if any), the position of primary flying control and pitch trim surfaces, outside air temperature, instrument landing system deviations, use of automatic flight control systems, use of VHF transmitters, radio altitude (if any), the level or availability of essential AC electricity supply and cockpit warnings relating to engine fire and engine shut-down, cabin pressurisation, presence of smoke and hydraulic/pneumatic power supply;
- (iv) either a cockpit voice recorder and a flight data recorder or a combined cockpit voice recorder/flight data recorder capable in either case of recording by reference to a time scale the data required to determine the following matters accurately in respect of the aeroplane: the flight path, speed, attitude, engine power, outside air temperature, configuration of lift and drag devices, use of VHF transmitters and use of automatic flight control systems;
- (v) a cockpit voice recorder and a flight data recorder capable of recording by reference to a time scale the data required to determine the following matters accurately in respect of the aeroplane: the flight path, speed, altitude, engine power, outside air temperature,

Status: This is the original version (as it was originally made). This item of legislation is currently only available in its original format.

configuration of lift and drag devices, use of VHF transmitters and use of automatic flight control systems;

- (vi) a cockpit voice recorder and a flight data recorder capable of recording by reference to a time scale the data required to determine the following matters accurately in respect of the aeroplane: the flight path, speed, altitude, engine power, outside air temperature, instrument landing system deviations, marker beacon passage, radio altitude, configuration of the landing gear and lift and drag devices, position of primary flying control and pitch trim surfaces, use of automatic flight control systems, use of VHF transmitters, ground speed/drift angle or latitude/longitude if the navigational equipment provided in the aeroplane is of such a nature as to enable this information to be recorded with reasonable practicability, cockpit warnings relating to engine fire, engine shut-down, cabin pressurisation, presence of smoke, essential AC electricity supply, hydraulic/pneumatic power supply, ground proximity and stalling;
- (vii) in respect of helicopters having a maximum total weight authorised exceeding 2,730 kg or a seating capacity exceeding 9 passengers, a 4 channel cockpit voice recorder which has attached to it an under-water sonar location device.

The cockpit voice recorder or flight data recorder or combined cockpit voice recorder/flight data recorder, as the case may be, shall be so constructed that the record would be likely to be preserved in the event of an accident:

Provided that an aircraft shall not be required to carry the said equipment, if before take-off the equipment is found to be unserviceable and the aircraft flies in accordance with arrangements approved by the Governor.

Scale SS

- (i) A 4 channel cockpit voice recorder capable of recording and retaining the data recorded during at least the last 30 minutes of its operation and a flight data recorder capable of recording and retaining the data recorded during at least the last 8 hours of its operation being the data required to determine by reference to a time scale the following matters accurately in respect of the helicopter or gyroplane:
 - (a) flight path;
 - (b) speed;
 - (c) altitude;
 - (d) engine power;
 - (e) main rotor speed;
 - (f) outside air temperature;
 - (g) position of pilot's primary flight controls;
 - (h) use of VHF transmitters;
 - (j) use of automatic flight controls (if any);
 - (k) use of stability augmentation system (if any);
 - (l) cockpit warnings relating to the master warning system; and
 - (m) selection of hydraulic system and cockpit warnings of failure of essential hydraulic systems.
- (ii) A 4 channel cockpit voice recorder capable of recording and retaining the data recorded during at least the last 30 minutes of its operation and a flight data recorder capable of recording and retaining the data recorded during at least the last 8 hours of its operation being the data required to determine by reference to a time scale the information specified

Status: This is the original version (as it was originally made). This item of legislation is currently only available in its original format.

in paragraph (i) of this Scale together with the following matters accurately in respect of the helicopter or gyroplane:

- (n) landing gear configuration;
 - (p) indicated sling load force if an indicator is provided in the helicopter or gyroplane of such a nature as to enable this information to be recorded with reasonable practicability;
 - (q) radio altitude;
 - (r) instrument landing system deviations;
 - (s) marker beacon passage;
 - (t) ground speed/drift angle or latitude/longitude if the navigational equipment provided in the helicopter or gyroplane is of such a nature as to enable this information to be recorded with reasonable practicability; and
 - (u) main gear box oil temperature and pressure.
- (iii) (a) A combined cockpit voice recorder/flight data recorder which meets the following requirements:
- (aa) in the case of a helicopter or gyroplane which is otherwise required to carry a flight data recorder specified at paragraph (i) of this Scale the flight data recorder shall be capable of recording the data specified therein and retaining it for the duration therein specified;
 - (bb) in the case of a helicopter or gyroplane which is otherwise required to carry a flight data recorder specified at paragraph (ii) of this Scale, the flight data recorder shall be capable of recording the data specified therein and retaining it for the duration therein specified;
 - (cc) the cockpit voice recorder shall be capable of recording and retaining at least the last hour of cockpit voice recording information on not less than three separate channels.
- (b) In any case when a combined cockpit voice recorder/flight data recorder specified at paragraph (iii)(a) of this Scale is required to be carried by or under this Order, the flight data recorder shall be capable of retaining as protected data the data recorded during at least the last 5 hours of its operation or the maximum duration of the flight, whichever is the greater. It shall also be capable of retaining additional data as unprotected data for a period which together with the period for which protected data is required to be retained amounts to a total of 8 hours:

Provided that the flight data recorder need not be capable of retaining the said additional data if additional data is retained which relates to the period immediately preceding the period to which the required protected data relates or for such other period or periods that the Governor may permit pursuant to Article 37 of this Order and the additional data is retained in accordance with arrangements approved by the Governor.

With the exception of flight data which it is expressly stated above may be unprotected, the cockpit voice recorder, flight data recorder or combined cockpit voice recorder and flight data recorder, as the case may be, shall be so constructed and installed that the record (herein referred to as 'protected data') would be likely to be preserved in the event of an accident and each cockpit voice recorder, flight data recorder or combined cockpit voice recorder/flight data recorder required to be carried on the helicopter or gyroplane shall have attached an automatically activated underwater sonar location device or an emergency locator radio transmitter as appropriate:

Status: This is the original version (as it was originally made). This item of legislation is currently only available in its original format.

Provided that a helicopter or gyroplane shall not be required to carry the said equipment if, before take-off, the equipment is found to be unserviceable and the aircraft flies in accordance with arrangements approved by the Governor.

Scale T

An underwater sonar location device except in respect of those helicopters or gyroplanes which have a device attached to a cockpit voice recorder in accordance with Scale S or are required to carry equipment in accordance with Scale SS.

Scale U

- (a) 1 survival beacon radio apparatus;
- (b) marine type pyrotechnical distress signals;
- (c) for each 4 or proportion of 4 persons on board, 100 grammes of glucose toffee tablets;
- (d) for each 4 or proportion of 4 persons on board, ½ litre of fresh water in durable containers;
- (e) first aid equipment.

Scale V

- (a) 1 survival beacon radio apparatus;
- (b) marine type pyrotechnical distress signals;
- (c) for each 4 or proportion of 4 persons on board, 100 grammes of glucose toffee tablets;
- (d) for each 4 or proportion of 4 persons on board, ½ litre of fresh water in durable containers;
- (e) first aid equipment;
- (f) for every 75 or proportion of 75 persons on board, 1 stove suitable for use with aircraft fuel;
- (g) 1 cooking utensil, in which snow or ice can be melted;
- (h) 2 snow shovels;
- (i) 2 ice saws;
- (j) single or multiple sleeping-bags, sufficient for the use of one-third of all persons on board;
- (k) 1 Arctic suit for each member of the crew of the aircraft.

Scale W

Cosmic radiation detection equipment calibrated in millirems per hour and capable of indicating the action and alert levels of radiation dose rate:

Provided that an aircraft shall not be required to carry the said equipment if before take-off the equipment is found to be unserviceable and it is not reasonably practicable to repair or replace it at the aerodrome of departure and the radiation forecast available to the commander of the aircraft indicates that hazardous radiation conditions are unlikely to be encountered by the aircraft on its intended route or any planned diversion therefrom.

Scale X

Equipment capable of giving warning to the pilot of the potentially hazardous proximity of ground or water:

Provided that if the equipment becomes unserviceable, the aircraft may fly or continue to fly until it first lands at a place at which it is reasonably practicable for the equipment to be repaired or replaced.

Scale Y1

Status: This is the original version (as it was originally made). This item of legislation is currently only available in its original format.

- (i) If the aircraft has a total seating capacity of not less than 60 and not exceeding 149 passengers, one portable battery-powered megaphone capable of conveying instructions to all persons in the passenger compartment and readily available for use by a member of the crew.
- (ii) If the aircraft has a total seating capacity exceeding 149 passengers, 2 portable battery-powered megaphones together capable of conveying instructions to all persons in the passenger compartments and readily available for use by a member of the crew.

Scale Y2

- (i) If the aircraft may in accordance with its certificate of airworthiness carry more than 19 and less than 100 passengers, one portable battery-powered megaphone capable of conveying instructions to all persons in the passenger compartment and readily available for use by a member of the crew.
- (ii) If the aircraft may in accordance with its certificate of airworthiness carry more than 99 and less than 200 passengers, 2 portable battery-powered megaphones together capable of conveying instructions to all persons in the passenger compartment and each readily available for use by a member of the crew.
- (iii) If the aircraft may in accordance with its certificate of airworthiness carry more than 199 passengers, 3 portable battery-powered megaphones together capable of conveying instructions to all persons in the passenger compartment and each readily available for use by a member of the crew.
- (iv) If the aircraft may in accordance with its certificate of airworthiness carry more than 19 passengers:
 - (a) a public address system; and
 - (b) an interphone system of communication between members of the flight crew and the cabin attendants.

Scale Z

- (i) An emergency lighting system to provide illumination in the passenger compartment sufficient to facilitate the evacuation of the aircraft notwithstanding the failure of the lighting systems specified in paragraph (ii) of Scale G.
- (ii) An emergency lighting system to provide illumination outside the aircraft sufficient to facilitate the evacuation of the aircraft.
- (iii) An emergency floor path lighting system in the passenger compartment sufficient to facilitate the evacuation of the aircraft notwithstanding the failure of the lighting systems specified in paragraph (ii) of Scale G:

Provided that if the equipment specified in this sub-paragraph (iii) becomes unserviceable the aircraft may fly or continue to fly in accordance with arrangements approved by the Governor.

SCHEDULE 6

Article 14

Radio and Radio Navigation Equipment to be carried in Aircraft

1. Every aircraft shall be provided, when flying in the circumstances specified in the first column of the Table set forth in paragraph 2 of this Schedule, with the scales of equipment respectively indicated in that Table:

Status: This is the original version (as it was originally made). This item of legislation is currently only available in its original format.

Provided that, if the aircraft is flying in a combination of such circumstances, the scales of equipment shall not on that account be required to be duplicated.

2.

Table

Aircraft and Circumstances of Flight	Scale of Equipment Required							
	A	B	C	D	E	F	G	H
(1) All aircraft within Hong Kong:	A				E**	F**		
(a) when flying under Instrument Flight Rules within controlled airspace								
(b) when flying within any airspace in respect of which special rules are prescribed by the Rules of the Air in relation to a								

* Unless the appropriate air traffic control unit otherwise permits in relation to the particular flight and provided that the aircraft complies with any instructions which the air traffic control unit may give in the particular case.

Status: This is the original version (as it was originally made). This item of legislation is currently only available in its original format.

Aircraft and Circumstances of Flight	Scale of Equipment Required							
	A	B	C	D	E	F	G	H
particular aerodrome, so as to require two-way radio communication with that aerodrome								
(b) when (c) making an approach to landing at an aerodrome notified for the purpose of this sub-paragraph.							G**	
(2) All aircraft (other than gliders) within Hong Kong:	A**				E**	F**		
(a) when flying at or above								

* Unless the appropriate air traffic control unit otherwise permits in relation to the particular flight and provided that the aircraft complies with any instructions which the air traffic control unit may give in the particular case.

Status: This is the original version (as it was originally made). This item of legislation is currently only available in its original format.

Aircraft and Circumstances of Flight	Scale of Equipment Required							
	A	B	C	D	E	F	G	H
flight level 245								
(b) when flying within such airspace as may be notified for the purposes of this sub-paragraph, being airspace in respect of which special rules are prescribed by the said Rules					E*			
(c) when flying at or above flight level 100					E*			
(3) All aircraft	A		C	D				H

* Unless the appropriate air traffic control unit otherwise permits in relation to the particular flight and provided that the aircraft complies with any instructions which the air traffic control unit may give in the particular case.

Status: This is the original version (as it was originally made). This item of legislation is currently only available in its original format.

Aircraft and Circumstances of Flight	A	B	C	D	E	F	G	H
registered in Hong Kong, wherever they may be:								
(a) when flying for the purpose of public transport under Instrument Flight Rules:								
(i) while making an approach to landing								
(ii) on all other occasions	A		C				H	
(iii) m(h)-engined aircraft when flying for the purpose of public transport under Visual Flight Rules	A(b)							H

* Unless the appropriate air traffic control unit otherwise permits in relation to the particular flight and provided that the aircraft complies with any instructions which the air traffic control unit may give in the particular case.

Status: This is the original version (as it was originally made). This item of legislation is currently only available in its original format.

Aircraft and Circumstances of Flight	Scale of Equipment Required							
	A	B	C	D	E	F	G	H
<p>(c) single-engine aircraft when flying for the purpose of public transport under Visual Flight Rules:</p> <p style="padding-left: 2em;">(i) over a route on which navigation is effected solely by visual reference to landmarks.</p> <p style="padding-left: 2em;">(ii) on all other occasions.</p> <p>Provided that aircraft which come within paragraphs (3)(b) and (3)(c) above</p>	A	B						

* Unless the appropriate air traffic control unit otherwise permits in relation to the particular flight and provided that the aircraft complies with any instructions which the air traffic control unit may give in the particular case.

Aircraft and Circumstances of Flight	A	B	C	D	E	F	G	H
<p>solely by virtue of the provisions of Article 98(6)(a)(iii) may carry instead of the requirements of the said paragraphs (3)(b) and (3)(c):</p> <p>(aa) over a route on which navigation is not effected solely by visual reference to landmarks</p> <p>(bb) over water, beyond gliding distance from any land</p> <p>when A(d) flying under</p>								

* Unless the appropriate air traffic control unit otherwise permits in relation to the particular flight and provided that the aircraft complies with any instructions which the air traffic control unit may give in the particular case.

Status: This is the original version (as it was originally made). This item of legislation is currently only available in its original format.

Aircraft and Circumstances of Flight	A	B	C	D	E	F	G	H
Instrument Flight Rules within controlled airspace and not required to comply with (3)paragraph (a) above								

* Unless the appropriate air traffic control unit otherwise permits in relation to the particular flight and provided that the aircraft complies with any instructions which the air traffic control unit may give in the particular case.

3. The scales of radio and radio navigation equipment indicated in the foregoing Table shall be as follows:

Scale A

Radio equipment capable of maintaining direct two-way communication with the appropriate aeronautical radio stations.

Scale B

Radio navigation equipment capable of enabling the aircraft to be navigated on the intended route including such equipment as may be prescribed.

Scale C

Radio equipment capable of receiving from the appropriate aeronautical radio stations meteorological broadcasts relevant to the intended flight.

Scale D

Radio navigation equipment capable of receiving signals from one or more aeronautical radio stations on the surface to enable the aircraft to be guided to a point from which a visual landing can be made at the aerodrome at which the aircraft is to land.

Scale E

Secondary surveillance radar equipment.

Scale F

Radio and radio navigation equipment capable of enabling the aircraft to be navigated along the intended route including:

- (i) automatic direction finding equipment;
- (ii) distance measuring equipment; and
- (iii) VHF omni-range equipment.

Scale G

Radio navigation equipment capable of enabling the aircraft to make an approach to landing using the Instrument Landing System.

Scale H

Radio navigation equipment capable of enabling the aircraft to be navigated on the intended route including:

- (a) automatic direction finding equipment;
- (b) distance measuring equipment;
- (c) duplicated VHF omni-range equipment; and
- (d) a 75 MHz marker beacon receiver.

Except that an aircraft may fly notwithstanding that it does not carry the equipment specified in this Scale if it carries alternate radio navigation equipment or navigational equipment approved by the Governor in writing in accordance with the provisions of Article 13(7) of this Order.

Where not more than one item of equipment specified in this Scale is unserviceable when the aircraft is about to begin a flight, the aircraft may nevertheless take off on that flight if:

- (i) it is not reasonably practicable for the repair or replacement of that item to be carried out before the beginning of the flight;
- (ii) the aircraft has not made more than one flight since the item was last serviceable; and
- (iii) the commander of the aircraft has satisfied himself that, taking into account the latest information available as to the route and aerodrome to be used (including any planned diversion) and the weather conditions likely to be encountered, the flight can be made safely and in accordance with any relevant requirements of the appropriate air traffic control unit.

4. In this Schedule—

(1) “automatic direction finding equipment” means radio navigation equipment which automatically indicates the bearing of any radio station transmitting the signals received by such equipment;

(2) “VHF omni-range equipment” means radio navigation equipment capable of giving visual indications of bearings of the aircraft by means of signals received from very high frequency omni-directional radio ranges;

(3) “distance measuring equipment” means radio navigation equipment capable of providing a continuous indication of the aircraft’s distance from the appropriate aeronautical radio stations; and

(4) “secondary surveillance radar equipment” means such type of radio navigation equipment as may be notified as being capable of (a) replying to an interrogation from secondary surveillance radar units on the surface and (b) being operated in accordance with such instructions as may be given to the aircraft by the appropriate air traffic control unit.

SCHEDULE 7

Article 15

AIRCRAFT, ENGINE AND PROPELLER LOG BOOKS

Aircraft Log Book

1. The following entries shall be included in the aircraft log book:

Status: This is the original version (as it was originally made). This item of legislation is currently only available in its original format.

- (a) the name of the constructor, the type of the aircraft, the number assigned to it by the constructor and the date of the construction of the aircraft;
- (b) the nationality and registration marks of the aircraft;
- (c) the name and address of the operator of the aircraft;
- (d) the date of each flight and the duration of the period between take-off and landing, or, if more than one flight was made on that day, the number of flights and the total duration of the periods between take-offs and landings on that day;
- (e) particulars of all maintenance work carried out on the aircraft or its equipment;
- (f) particulars of any defects occurring in the aircraft or in any equipment required to be carried therein by or under this Order, and of the action taken to rectify such defects including a reference to the relevant entries in the technical log required by Article 10(2) and (3) of this Order;
- (g) particulars of any overhauls, repairs, replacements and modifications relating to the aircraft or any such equipment as aforesaid:

Provided that entries shall not be required to be made under sub-paragraphs (e), (f) and (g) in respect of any engine or variable pitch propeller.

Engine Log Book

2. The following entries shall be included in the engine log book:

- (a) the name of the constructor, the type of the engine, the number assigned to it by the constructor and the date of the construction of the engine;
- (b) the nationality and registration marks of each aircraft in which the engine is fitted;
- (c) the name and address of the operator of each such aircraft;
- (d) either:
 - (i) the date of each flight and the duration of the period between take-off and landing or, if more than one flight was made on that day, the number of flights and the total duration of the periods between take-offs and landings on that day; or
 - (ii) the aggregate duration of periods between take-off and landing for all flights made by that aircraft since the immediately preceding occasion that any maintenance, overhaul, repair, replacement, modification or inspection was undertaken on the engine;
- (e) particulars of all maintenance work done on the engine;
- (f) particulars of any defects occurring in the engine, and of the rectification of such defects, including a reference to the relevant entries in the technical log required by Article 10(2) and (3) of this Order;
- (g) particulars of all overhauls, repairs, replacements and modifications relating to the engine or any of its accessories.

Variable Pitch Propeller Log Book

3. The following entries shall be included in the variable pitch propeller log book:

- (a) the name of the constructor, the type of the propeller, the number assigned to it by the constructor and the date of the construction of the propeller;
- (b) the nationality and registration marks of each aircraft, and the type and number of each engine, to which the propeller is fitted;
- (c) the name and address of the operator of each such aircraft;
- (d) either:

Status: This is the original version (as it was originally made). This item of legislation is currently only available in its original format.

- (i) the date of each flight and the duration of the period between take off and landing or, if more than one flight was made on that day, the number of flights and the total duration of the periods between take-offs and landings on that day; or
- (ii) the aggregate duration of periods between take-off and landing for all flights made by that aircraft since the immediately preceding occasion that any maintenance, overhaul, repair, replacement, modification or inspection was undertaken on the propeller;
- (e) particulars of all maintenance work done on the propeller;
- (f) particulars of any defects occurring in the propeller, and of the rectification of such defects, including a reference to the relevant entries in the technical log required by Article 10(2) and (3) of this Order;
- (g) particulars of any overhauls, repairs, replacements and modifications relating to the propeller.

SCHEDULE 8

Article 18(4)

AREAS SPECIFIED IN CONNECTION WITH THE CARRIAGE OF FLIGHT NAVIGATORS AS MEMBERS OF THE FLIGHT CREWS OR APPROVED NAVIGATIONAL EQUIPMENT ON PUBLIC TRANSPORT AIRCRAFT

The following areas are hereby specified for the purposes of Article 18(4) of this Order:

Area A—Arctic

All that area north of latitude 68° north, but excluding any part thereof within the area enclosed by rhumb lines joining successively the following points:

- 68° north latitude 00° east/west longitude
- 73° north latitude 15° east longitude
- 73° north latitude 30° east longitude
- 68° north latitude 45° east longitude
- 68° north latitude 00° east/west longitude

Area B—Antarctic

All that area south of latitude 55° south.

Area C—Sahara

All that area enclosed by rhumb lines joining successively the following points:

- 30° north latitude 05° west longitude
- 24° north latitude 11° west longitude
- 14° north latitude 11° west longitude
- 14° north latitude 28° east longitude
- 24° north latitude 28° east longitude
- 28° north latitude 23° east longitude
- 30° north latitude 15° east longitude
- 30° north latitude 05° west longitude

Area D—(deleted)

Area E—South America

All that area enclosed by rhumb lines joining successively the following points:

Status: This is the original version (as it was originally made). This item of legislation is currently only available in its original format.

04° north latitude 72° west longitude
04° north latitude 60° west longitude
08° south latitude 42° west longitude
18° south latitude 54° west longitude
18° south latitude 60° west longitude
14° south latitude 72° west longitude
05° south latitude 76° west longitude
04° north latitude 72° west longitude

Area F—Pacific Ocean

All that area enclosed by rhumb lines joining successively the following points:

60° north latitude 180° east/west longitude
20° north latitude 128° east longitude
04° north latitude 128° east longitude
04° north latitude 180° east/west longitude
55° south latitude 180° east/west longitude
55° south latitude 82° west longitude
25° south latitude 82° west longitude
60° north latitude 155° west longitude
60° north latitude 180° east/west longitude

Area G—Australia

All that area enclosed by rhumb lines joining successively the following points:

18° south latitude 123° east longitude
30° south latitude 118° east longitude
30° south latitude 135° east longitude
18° south latitude 123° east longitude

Area H—Indian Ocean

All that area enclosed by rhumb lines joining successively the following points:

35° south latitude 110° east longitude
55° south latitude 180° east/west longitude
55° south latitude 10° east longitude
40° south latitude 10° east longitude
25° south latitude 60° east longitude
20° south latitude 60° east longitude
05° south latitude 43° east longitude
10° north latitude 55° east longitude
10° north latitude 73° east longitude
04° north latitude 77° east longitude
04° north latitude 92° east longitude
10° south latitude 100° east longitude

10° south latitude 110° east longitude

35° south latitude 110° east longitude

Area I—North Atlantic Ocean

All that area enclosed by rhumb lines joining successively the following points:

55° north latitude 15° west longitude

68° north latitude 28° west longitude

68° north latitude 60° west longitude

45° north latitude 45° west longitude

40° north latitude 60° west longitude

40° north latitude 19° west longitude

55° north latitude 15° west longitude

Area J—South Atlantic Ocean

All that area enclosed by rhumb lines joining successively the following points:

40° north latitude 60° west longitude

18° north latitude 60° west longitude

05° south latitude 30° west longitude

55° south latitude 55° west longitude

55° south latitude 10° east longitude

40° south latitude 10° east longitude

02° north latitude 05° east longitude

02° north latitude 10° west longitude

15° north latitude 25° west longitude

40° north latitude 19° west longitude

40° north latitude 60° west longitude

Area K—Northern Canada

All that area enclosed by rhumb lines joining successively the following points:

68° north latitude 130° west longitude

55° north latitude 115° west longitude

55° north latitude 70° west longitude

68° north latitude 60° west longitude

68° north latitude 130° west longitude

Area L—Northern Asia

All that area enclosed by rhumb lines joining successively the following points:

68° north latitude 56° east longitude

68° north latitude 160° east longitude

50° north latitude 125° east longitude

50° north latitude 56° east longitude

68° north latitude 56° east longitude

Area M—Southern Asia

Status: This is the original version (as it was originally made). This item of legislation is currently only available in its original format.

All that area enclosed by rhumb lines joining successively the following points:

- 50° north latitude 56° east longitude
- 50° north latitude 125° east longitude
- 40° north latitude 110° east longitude
- 30° north latitude 110° east longitude
- 30° north latitude 80° east longitude
- 35° north latitude 80° east longitude
- 35° north latitude 56° east longitude
- 50° north latitude 56° east longitude

SCHEDULE 9

Article 20

FLIGHT CREW OF AIRCRAFT, LICENCES AND RATINGS

PART A —LICENCES

Minimum Age, Period of Validity, Privileges

1. Aeroplane Pilots

Private Pilot's Licence (Aeroplanes)

Minimum age—17 years

No Maximum Period of Validity

Privileges: The holder of the licence shall be entitled to fly as pilot in command or co-pilot of an aeroplane of any of the types specified or otherwise falling within the aircraft rating included in the licence:

Provided that:

- (a) he shall not fly such an aeroplane for the purpose of public transport or aerial work save as hereinafter provided—
 - (i) he may fly such an aeroplane for the purpose of aerial work which consists of:
 - (aa) the giving of instruction in flying, if his licence includes a flying instructor's rating or an assistant flying instructor's rating; or
 - (bb) the conducting of flying tests for the purposes of this Order, in either case in an aeroplane owned, or operated under arrangements entered into, by a flying club of which the person giving the instruction or conducting the test and the person receiving the instruction or undergoing the test are both members;
 - (ii) he may fly such an aeroplane for the purpose of aerial work which consists of:
 - (aa) towing a glider in flights; or
 - (bb) a flight for the purpose of dropping of persons by parachute,

- in either case in an aeroplane owned, or operated under arrangements entered into by a club of which the holder of the licence and any person carried in the aircraft or in any glider towed by the aircraft are members;
- (b) he shall not receive any remuneration for his services as a pilot, other than remuneration for the giving of such instruction or the conducting of such flying tests as are specified in sub-paragraph (a) (i) of this proviso;
 - (c) he shall not, unless his licence includes an instrument rating (aeroplanes), fly as pilot in command of such an aeroplane—
 - (i) on a flight outside controlled airspace—
 - (aa) when the flight visibility is less than 1½ nautical miles; or
 - (bb) when any passenger is carried and the aeroplane is flying either above 3000 feet above mean sea level in Instrument Meteorological Conditions or at or below 3000 feet above mean sea level in a flight visibility of less than 3 nautical miles;
 - (ii) on a special VFR flight in a control zone in a flight visibility of less than 5 nautical miles except on a route or in an aerodrome traffic zone notified for the purposes of this sub-paragraph;
 - (iii) out of sight of the surface; and
 - (d) he shall not fly as pilot in command of such an aeroplane at night unless—
 - (i) his licence includes a night rating (aeroplanes), and
 - (ii) his licence includes an instrument rating (aeroplanes) or he has within the immediately preceding 13 months carried out as pilot in command not less than 5 take-offs and 5 landings at a time when the depression of the centre of the sun was not less than 12° below the horizon.

Commercial Pilot's Licence (Aeroplanes)

Minimum Age—18 years

Maximum Period of Validity—10 years

Privileges:

(1) The holder of the licence shall be entitled to exercise the privileges of a Private Pilot's Licence (Aeroplanes) which includes a night rating (aeroplanes) and shall be entitled to fly as pilot in command of an aeroplane—

- (a) on a special VFR flight notwithstanding that the flight visibility is less than 1½ nautical miles;
- (b) when the aeroplane is taking off or landing at any place notwithstanding that the flight visibility below cloud is less than 1 nautical mile.

(2) He shall be entitled to fly as pilot in command of an aeroplane of a type specified in Part 1 of the aircraft rating included in the licence when the aeroplane is engaged on a flight for any purpose whatsoever:

Provided that—

- (a) he shall not, unless his licence includes an instrument rating (aeroplanes), fly such an aeroplane on any scheduled journey;
- (b) he shall not fly such an aeroplane at night unless his licence includes an instrument rating (aeroplanes) or he has within the immediately preceding 13 months carried out as pilot in command not less than five take-offs and five landings at a time when the depression of the centre of the sun was not less than 12° below the horizon;

Status: This is the original version (as it was originally made). This item of legislation is currently only available in its original format.

- (c) he shall not, unless his licence includes an instrument rating (aeroplanes), fly any such aeroplane of which the maximum total weight authorised exceeds 2,300 kg on any flight for the purpose of public transport, except a flight beginning and ending at the same aerodrome and not extending beyond 25 nautical miles from that aerodrome;
 - (d) he shall not fly such an aeroplane on a flight for the purpose of public transport unless it is certified for single pilot operation;
 - (e) he shall not fly such an aeroplane on any flight for the purpose of public transport after he attains the age of 60 years unless the aeroplane is fitted with dual controls and carries a second pilot who has not attained the age of 60 years and who holds an appropriate licence under this Order entitling him to act as pilot in command or co-pilot of that aeroplane.
- (3) He shall be entitled to fly as co-pilot of any aeroplane of a type specified in the aircraft rating included in the licence when the aeroplane is engaged on a flight for any purpose whatsoever:
- Provided that he shall not act as co-pilot of any aeroplane whose maximum total weight authorised exceeds 20,000 kg on any flight for the purpose of public transport after he attains the age of 60 years.
- (4) He shall not at any time after he attains the age of 65 years act as pilot in command or co-pilot of any aeroplane on a flight for the purpose of public transport.

Airline Transport Pilot's Licence (Aeroplanes)

Minimum Age—21 years

Maximum Period of Validity—10 years

Privileges: The holder of the licence shall be entitled to exercise the privileges of a Commercial Pilot's Licence (Aeroplanes) except the proviso (d) to paragraph (2) of those privileges shall not apply and the holder of the licence shall not at any time after he attains the age of 60 years act as pilot in command or co-pilot of any aeroplane for the purpose of public transport if its maximum total weight authorised exceeds 20,000 kg.

2. Helicopter and Gyroplane Pilots

Private Pilot's Licence (Helicopters and Gyroplanes)

Minimum Age—17 years

No Maximum Period of Validity

Privileges: The holder of the licence shall be entitled to fly as pilot in command or co-pilot of a helicopter or gyroplane of any of the types specified in the aircraft rating included in the licence:

Provided that—

- (a) he shall not fly such a helicopter or gyroplane for the purpose of public transport or aerial work other than aerial work which consists of—
 - (i) the giving of instruction in flying if his licence includes a flying instructor's rating or an assistant flying instructor's rating;
 - (ii) the conducting of flying tests for the purposes of this Order;
in either case in a helicopter or gyroplane owned, or operated under arrangements entered into, by a flying club of which the person giving the instruction or conducting the test and the person receiving the instruction or undergoing the test are both members;
- (b) he shall not receive any remuneration for his services as a pilot on a flight other than remuneration for the giving of such instruction or the conducting of such flying tests as are specified in paragraph (a) of this proviso;

Status: This is the original version (as it was originally made). This item of legislation is currently only available in its original format.

- (c) he shall not fly as pilot in command of such a gyroplane at night unless his licence includes a night rating (helicopters and gyroplanes) and he has within the immediately preceding 13 months carried out as pilot in command not less than 5 take-offs and 5 landings at a time when the depression of the centre of the sun was not less than 12° below the horizon;
- (d) he shall not fly as pilot in command of such a helicopter at night unless—
 - (i) his licence includes a night rating (helicopters and gyroplanes); and
 - (ii) his licence includes an instrument rating (helicopters) or he has within the immediately preceding 13 months carried out as pilot in command not less than 5 flights, each consisting of a take-off, a transition from hover to forward flight, a climb to at least 500 feet and a landing, at a time when the depression of the centre of the sun was not less than 12° below the horizon;
- (e) he shall not unless his licence includes an instrument rating (helicopters) fly as pilot in command or co-pilot of such a helicopter flying in airspace notified for the purposes of this Schedule:
 - (i) in conditions such that he cannot comply with the specified minimum weather provisions; or
 - (ii) in circumstances which require compliance with Instrument Flight Rules.

Commercial Pilot's Licence (Helicopters and Gyroplanes)

Minimum Age—18 years

Maximum Period of Validity—10 years

Privileges:

(1) The holder of the licence shall be entitled to exercise the privileges of a Private Pilot's Licence (Helicopters and Gyroplanes) which includes a night rating (helicopters and gyroplanes).

(2) He shall be entitled to fly as pilot in command of any helicopter or gyroplane specified in Part 1 of the aircraft rating included in the licence when the helicopter or gyroplane is engaged on a flight for any purpose whatsoever:

Provided that—

- (a) he shall not, unless his licence includes an instrument rating (helicopters), fly such a helicopter on any scheduled journey or on any flight for the purpose of public transport in Instrument Meteorological Conditions;
- (b) he shall not fly such a helicopter or gyroplane on a flight for the purpose of public transport unless it is certificated for single pilot operation;
- (c) he shall not fly such a gyroplane at night unless he has within the immediately preceding 13 months carried out as a pilot in command not less than 5 take-offs and 5 landings at a time when the depression of the centre of the sun was not less than 12° below the horizon;
- (d) he shall not fly such a helicopter at night unless his licence includes an instrument rating (helicopters) or he has within the immediately preceding 13 months carried out as pilot in command not less than 5 flights, each consisting of a take-off, a transition from hover to forward flight, a climb to at least 500 feet and a landing, at a time when the depression of the centre of the sun was not less than 12° below the horizon;
- (e) he shall not fly such a helicopter or gyroplane on any flight for the purpose of public transport after he attains the age of 60 years unless the helicopter or gyroplane is fitted with dual controls and carries a second pilot who has not attained the age of 60 years and who holds an appropriate licence under this Order entitling him to act as pilot in command or co-pilot of that helicopter or gyroplane;

Status: This is the original version (as it was originally made). This item of legislation is currently only available in its original format.

- (f) he shall not unless his licence includes an instrument rating (helicopters) fly as pilot in command or co-pilot of such a helicopter flying in airspace notified for the purposes of this Schedule:
 - (i) in conditions such that he cannot comply with the specified minimum weather provisions; or
 - (ii) in circumstances which require compliance with the Instrument Flight Rules.
- (3) He shall be entitled to fly as co-pilot of any helicopter or gyroplane specified in the aircraft rating included in the licence when the helicopter or gyroplane is engaged on a flight for any purpose whatsoever:

Provided that he shall not act as co-pilot of any helicopter or gyroplane whose maximum total weight authorised exceeds 20,000 kg on any flight for the purpose of public transport after he attains the age of 60 years.
- (4) He shall not at any time after he attains the age of 65 years act as pilot in command or co-pilot of any helicopter or gyroplane on a flight for the purpose of public transport.

Airline Transport Pilot's Licence (Helicopters and Gyroplanes)

Minimum Age—21 years

Maximum Period of Validity—10 years

Privileges: The holder of the licence shall be entitled to exercise the privileges of a Commercial Pilot's Licence (Helicopters and Gyroplanes) except that proviso (b) to paragraph (2) of those privileges shall not apply and the holder of the licence shall not at any time after he attains the age of 60 years act as pilot in command or co-pilot of any helicopter or gyroplane for the purpose of public transport if its maximum total weight authorised exceeds 20,000 kg.

3. Balloon and Airship Pilots

Private Pilot's Licence (Balloons and Airships)

Minimum Age—17 years

No Maximum Period of Validity

Privileges: The holder of the licence shall be entitled to fly as pilot in command of any type of balloon or airship specified in Part 1 of the aircraft rating included in the licence and co-pilot of any type of balloon or airship specified in such aircraft rating:

Provided that—

- (a) he shall not fly such balloon or airship for the purpose of public transport or aerial work, other than aerial work which consists of the giving of instruction in flying or the conducting of flying tests in either case in a balloon or airship owned, or operated under arrangements entered into, by a flying club of which the person giving the instruction or conducting the test and the person receiving the instruction or undergoing the test are both members;
- (b) he shall not receive any remuneration for his services as pilot on a flight other than remuneration for the giving of such instruction or the conducting of such flying tests as are specified in paragraph (a) of this proviso.
- (c) he shall not fly such a balloon unless he has within the immediately preceding 13 months carried out as pilot in command in a free balloon 5 flights each of not less than 5 minutes duration.

Commercial Pilot's Licence (Balloons)

Minimum Age—18 years

Maximum Period of Validity—6 months(18)*

Privileges:

(1) The holder of the licence shall be entitled to exercise the privileges of a Private Pilot's Licence (Balloons and Airships).

(2) He shall be entitled to fly, when the balloon is flying for any purpose whatsoever, as pilot in command or co-pilot of any type of balloon specified in the aircraft rating included in the licence:

Provided that he shall not act as pilot in command on a flight for the purpose of the public transport of passengers unless he has within the immediately preceding 90 days carried out as pilot in command in a free balloon 3 flights each of not less than 5 minutes duration.

Commercial Pilot's Licence (Airships)

Minimum Age—17 years

Maximum Period of Validity—10 years

Privileges:

(1) The holder of the licence shall be entitled to exercise the privileges of a Private Pilot's Licence (Balloons and Airships).

(2) He shall be entitled to fly, when the airship is flying for any purpose whatsoever, as pilot in command of any type of airship specified in Part 1 of the aircraft rating included in the licence and as co-pilot of any type of airship specified in such aircraft rating.

4. Glider Pilots

Private Pilot's Licence (Glider)

Minimum Age—17 years

No Maximum Period of Validity(18)

Privileges: The holder of the licence shall be entitled to fly as pilot in command or co-pilot of a glider of any of the types specified in the aircraft rating included in the licence:

Provided that:

(a) he shall not fly such a glider for the purpose of public transport or aerial work other than aerial work which consists of:

(i) the giving of instruction in gliding if his licence includes a flying instructor's rating or an assistant instructor's rating; or

(ii) the conducting of flying tests for the purposes of this Order;

in either case in a glider owned, or operated under arrangements entered into, by a flying club of which the person giving the instruction or conducting the test and the person receiving the instruction or undergoing the test are both members.

(b) he shall not receive any remuneration for his services as a pilot on a flight other than remuneration for the giving of such instruction or the conducting of such flying tests as are specified in paragraph (a) of this proviso.

Commercial Pilot's Licence (Glider)

Minimum Age—18 years

Maximum Period of Validity—10 years

(18) In respect of the privileges of a Private Pilot's Licence the maximum period of validity shall be as given for that licence.

(18) In respect of the privileges of a Private Pilot's Licence the maximum period of validity shall be as given for that licence.

Status: This is the original version (as it was originally made). This item of legislation is currently only available in its original format.

Privileges: The holder of the licence shall be entitled to fly for any purpose as pilot in command or co-pilot of—

- (a) any glider of which the maximum total weight authorised does not exceed 680 kg;
- (b) any glider of which the maximum total weight authorised exceeds 680 kg and which is of a type specified in the rating included in the licence.

5. Other Flight Crew

Flight Navigator's Licence

Minimum Age—21 years

Maximum Period of Validity—10 years

Privileges: The holder of the licence shall be entitled to act as flight navigator in any aircraft.

Flight Engineer's Licence

Minimum Age—21 years

Maximum Period of Validity—10 years

Privileges: The holder of the licence shall be entitled to act as flight engineer in any type of aircraft specified in the aircraft rating included in the licence.

Flight Radiotelephony Operator's General Licence

Minimum Age—18 years

Maximum Period of Validity—10 years

Privileges: The holder of the licence shall be entitled to operate radiotelephony apparatus in any aircraft.

Flight Radiotelephony Operator's Restricted Licence

Minimum Age—17 years

Maximum Period of Validity—10 years

Privileges: The holder of the licence shall be entitled to operate radiotelephony apparatus in any aircraft if the stability of the frequency radiated by the transmitter is maintained automatically but shall not be entitled to operate the transmitter, or to adjust its frequency, except by the use of external switching devices.

Flight Radiotelegraphy Operator's Licence

Minimum Age—20 years

Maximum Period of Validity—12 months

Privileges: The holder of the licence shall be entitled to operate radiotelegraphy and radiotelephony apparatus in any aircraft.

Flight Radiotelegraphy Operator's Temporary Licence

Minimum Age—18 years

Maximum Period of Validity—12 months

Privileges: The holder of the licence shall be entitled to operate radiotelegraphy and radiotelephony apparatus in any aircraft under the supervision of a person who is the holder of a flight radiotelegraphy operator's licence.

PART B

—RATINGS

1. The following ratings may be included in a pilot's licence granted under Part IV of this Order, and subject to the provisions of this Order and of the licence, the inclusion of a rating in a licence shall have the consequences respectively specified as follows—

Aircraft Ratings: The licence shall entitle the holder to act as pilot of aircraft of the types specified in the aircraft rating and different types of aircraft may be specified in respect of different privileges of a licence.

Instrument Rating (Aeroplanes) shall entitle the holder of the licence to act as pilot in command or co-pilot of an aeroplane flying in airspace notified for the purpose of this Schedule either in conditions such that he cannot comply with the specified minimum weather provisions or in circumstances which require compliance with the Instrument Flight Rules.

Instrument Rating (Helicopters) shall entitle the holder of the licence to act as pilot in command or co-pilot of a helicopter flying in airspace notified for the purpose of this Schedule either in conditions such that he cannot comply with the specified minimum weather provisions or in circumstances which require compliance with the Instrument Flight Rules.

Night Rating (Aeroplanes) shall entitle the holder of a private pilot's licence (aeroplanes) to act as pilot in command of an aeroplane at night.

Night Rating (Helicopters and Gyroplanes) shall entitle the holder of a private pilot's licence (helicopters and gyroplanes) to act as pilot in command of a helicopter or gyroplane at night.

Towing Rating (Flying Machines) shall entitle the holder of the licence to act as pilot of a flying machine while towing a glider in flight for the purposes of public transport or aerial work.

Flying Instructor's Rating shall entitle the holder of the licence to give instruction in flying aircraft of such types as may be specified in the rating for that purpose.

Assistant Flying Instructor's Rating shall entitle the holder of the licence to give instruction in flying aircraft of such types as may be specified in the rating for that purpose:—

Provided that—

- (a) such instruction shall only be given under the supervision of a person present during the take-off and landing at the aerodrome at which the instruction is to begin and end and holding a pilot's licence endorsed with a flying instructor's rating; and
- (b) an assistant flying instructor's rating shall not entitle the holder of the licence to give directions to the person undergoing instruction in respect of the performance by that person of—
 - (i) his first solo flight;
 - (ii) his first solo flight by night;
 - (iii) his first solo cross-country flight otherwise than by night; or
 - (iv) his first solo cross-country flight by night.

2. An aircraft rating included in a flight engineer's licence shall entitle the holder of the licence to act as flight engineer only of aircraft of a type specified in the aircraft rating.

3. For the purposes of this Schedule—

“Solo flight” means a flight on which the pilot of the aircraft is not accompanied by a person holding a pilot's licence granted or rendered valid under this Order.

“Cross-country flight” means any flight during the course of which the aircraft is more than 3 nautical miles from the aerodrome of departure.

Status: This is the original version (as it was originally made). This item of legislation is currently only available in its original format.

PART C

—CERTIFICATE OF TEST OR EXPERIENCE

- (a) (a) A certificate of test or certificate of experience required by Article 20(4) of this Order shall not be appropriate to the functions to be performed on a flight unless it is a certificate appropriate to the description of the flight according to the following Table:

<i>Case</i>	<i>Class of Licence</i>	<i>Description of Flight</i>	<i>Certificate Required</i>
A.	Private Pilot's Licence (Aeroplanes) Private Pilot's Licence (Helicopters and Gyroplanes)	Any flight within the privileges of the licence	Certificate of test or certificate of experience
B.	Commercial Pilot's Licence (Aeroplanes) Commercial Pilot's Licence (Helicopters and Gyroplanes) Commercial Pilot's Licence (Gliders) Commercial Pilot's Licence (Airships) Airline Transport Pilot's Licence (Aeroplanes) Airline Transport Pilot's Licence (Helicopters and Gyroplanes)	Carriage of passengers on a flight in respect of which the holder of the licence receives remuneration	Certificate of test
C.	Commercial Pilot's Licence (Aeroplanes) Commercial Pilot's Licence (Helicopters and Gyroplanes)	For public transport	Certificate of test

Status: This is the original version (as it was originally made). This item of legislation is currently only available in its original format.

<i>Case</i>	<i>Class of Licence</i>	<i>Description of Flight</i>	<i>Certificate Required</i>
	Commercial Pilot's Licence (Gliders)		
	Commercial Pilot's Licence (Airships)		
	Airline Transport Pilot's Licence (Aeroplanes)		
	Airline Transport Pilot's Licence (Helicopters and Gyroplanes)		
D.	Commercial Pilot's Licence (Aeroplanes)	For aerial work	Certificate of test or certificate of experience
	Commercial Pilot's Licence (Helicopters and Gyroplanes)		
	Commercial Pilot's Licence (Gliders)		
	Commercial Pilot's Licence (Airships)		
	Airline Transport Pilot's Licence (Aeroplanes)		
	Airline Transport Pilot's Licence (Helicopters and Gyroplanes)		
E.	Commercial Pilot's Licence (Aeroplanes)	Any flight within the privileges of a Private Pilot's Licence	Certificate of test or certificate of experience
	Commercial Pilot's Licence (Helicopters and Gyroplanes)		

Status: This is the original version (as it was originally made). This item of legislation is currently only available in its original format.

<i>Case</i>	<i>Class of Licence</i>	<i>Description of Flight</i>	<i>Certificate Required</i>
	Commercial Pilot's Licence (Gliders)		
	Commercial Pilot's Licence (Airships)		
	Airline Transport Pilot's Licence (Aeroplanes)		
	Airline Transport Pilot's Licence (Helicopters and Gyroplanes)		
F.	Flight Navigator's Licence	Flights to which Article 18(4) of this Order applies	Certificate of experience
G.	Flight Engineer's Licence	For public transport	Certificate of test
H.	Flight Engineer's Licence	Any flight other than for public transport	Certificate of test or certificate of experience

- (b) For the purposes of this Part of this Schedule references to Cases are references to the cases indicated in the first Column of the Table in paragraph 1(a) of this Part of this Schedule.

Certificate of test

2. A certificate of test required by Article 20(4) or 20(5) of this Order shall be signed by a person authorised by the Governor to sign certificates of this kind and shall certify the following particulars:

- (a) the functions to which the certificate relates;
- (b) that the person signing the certificate is satisfied that on a date specified in the certificate the holder of the licence or personal flying logbook of which the certificate forms part, as the case may be, passed an appropriate test of his ability to perform the functions to which the certificate relates;
- (c) the type of aircraft or flight simulator in or by means of which the test was conducted; and
- (d) the date on which it was signed.

Nature of test

3. The appropriate test referred to in paragraph 2 of this Part of this Schedule shall be:

- (a) in the case of a test which entitles the holder of the licence of which the certificate forms part to act as pilot in command and/or co-pilot of aircraft of the type specified in the certificate, a test of the pilot's competence to fly the aircraft as pilot in command and/or co-pilot and shall where the Governor so specifies in respect of the whole or part of

- a test be conducted in an aircraft in flight or by means of a flight simulator approved by the Governor;
- (b) in the case of a test which entitles the holder of the licence of which the certificate forms part to act as flight engineer of aircraft of the type specified in the certificate, a test of the flight engineer's competence to perform the duties of a flight engineer in the type of aircraft to be used on the flight and shall, where the Governor so specifies in respect of the whole or part of a test, be conducted in an aircraft in flight or by means of a flight simulator approved by the Governor;
 - (c) in the case of a test which entitles the holder of the licence of which the certificate forms part to perform the functions to which an Instrument Rating relates a test of his ability to perform the functions to which the rating relates and shall, where the Governor so specifies in respect of the whole or part of the test, be conducted in an aircraft in flight or by means of a flight simulator approved by the Governor;
 - (d) in the case of a test which entitles the holder of the licence of which the certificate forms part to perform the functions to which a flying instructor's rating or an assistant flying instructor's rating relates, a test of his ability to perform the functions to which the rating relates and shall where the Governor so specifies in respect of the whole or part of the test be conducted in an aircraft in flight.

Period of Validity of Certificate of Test

- (a) (a) A certificate of test required by Article 20(4) of this Order in respect of a Commercial Pilot's Licence (Balloons) shall not be valid in relation to a flight made more than 13 months after the date of the test which it certifies and in respect of any other licence shall not be valid in relation to a flight made more than 13 months in Cases A, B, E and H, or more than 6 months in Cases C, D and G, after the date of the test which it certifies:
 - Provided that in the case of Cases C, D and G two certificates of test shall together be deemed to constitute a valid certificate of test if they certify flying tests conducted on two occasions within the period of 13 months preceding the flight on which the functions are to be performed, such occasions being separated by an interval of not less than 4 months, and if both certificates are appropriate to those functions.
- (b) A certificate of test required by Article 20(5) of this Order shall not be valid in relation to a flight made more than 13 months in the case of an instrument rating (aeroplanes) and an assistant flying instructor's rating or more than 25 months in the case of a flying instructor's rating, after the date of the test which it certifies.

Certificate of experience

5. A certificate of experience required by Article 20(4) of this Order shall be signed by a person authorised by the Governor to sign such a certificate and shall certify the following particulars:

- (a) the functions to which the certificate relates;
- (b) in the case of a pilot or flight engineer, that on the date on which the certificate was signed the holder of the licence or personal flying logbook of which it forms part, as the case may be, produced his personal flying logbook to the person signing the certificate and satisfied him that he had appropriate experience in the capacity to which his licence relates within the appropriate period specified in paragraph 6 of this Part of this Schedule;
- (c) in the case of a flight navigator, that on the date on which the certificate was signed the holder of the licence of which it forms part produced his navigation logs, charts and workings of astronomical observations to the person signing the certificate and satisfied

Status: This is the original version (as it was originally made). This item of legislation is currently only available in its original format.

him that he had appropriate experience in the capacity to which the licence relates within the appropriate period specified in paragraph 6 of this Part of this Schedule;

- (d) in the case of a pilot or flight engineer, the type or types of aircraft in which the experience was gained;
- (e) the date on which it was signed.

Period of experience

6. A certificate of experience shall not be valid unless the experience certified was gained within the period of 13 months preceding the signing of the certificate in the case of Cases A, E, F and H, or 6 months preceding the signing of the certificate in the case of Case D.

Period of Validity of Certificate of Experience

7. A certificate of experience in respect of a Commercial Pilot's Licence (Balloons) shall not be valid more than 13 months after it was signed and in respect of any other licence shall not be valid more than 6 months after it was signed for Case D, nor more than 13 months after it was signed for any other Case.

SCHEDULE 10

Article 66(2)

AIR TRAFFIC CONTROLLERS: RATINGS

1. The holder of a licence which includes ratings of two or more of the classes specified in paragraph 2 of this Schedule shall not at any one time perform the functions specified in respect of more than one of those ratings:

Provided that the functions of any one of the following groups of ratings may be exercised at the same time—

- (a) The aerodrome control rating and the approach control rating;
- (b) The approach control rating and the approach radar control rating; except that the functions of the approach control rating shall not be exercised at the same time as the functions of the approach radar control rating if the service being provided under the latter is a surveillance radar approach terminating at a point less than 2 nautical miles from the point of intersection of the glide path with the runway;
- (c) The area control rating and the area radar control rating.

2. Ratings of the following classes may be included in an air traffic controller's licence (other than a student air traffic controller's licence) granted under Article 65 of this Order and, subject to the provisions of this Order and of the licence, the inclusion of a rating in a licence shall have the consequences respectively specified as follows—

(1) *Aerodrome Control Rating* shall entitle the holder of the licence for which the rating is valid, to provide air traffic control service (but not with any type of radar equipment for which a radar control rating is required under this paragraph) for any aircraft on the manoeuvring area or apron of that aerodrome or which is flying in the vicinity of the aerodrome traffic zone by visual reference to the surface.

(2) *Approach Control Rating* shall entitle the holder of the licence, at any aerodrome for which the rating is valid, to provide air traffic control service (but not with any type of radar equipment for which a radar control rating is required under this paragraph) for any aircraft which is flying in the vicinity of the aerodrome traffic zone whether or not it is flying by visual reference to the surface.

Status: This is the original version (as it was originally made). This item of legislation is currently only available in its original format.

(3) *Approach Radar Control Rating* shall entitle the holder of the licence, at any aerodrome for which the rating is valid, to provide air traffic control service with the aid of any type of surveillance radar equipment for which the rating is valid for any aircraft which is flying within 40 nautical miles of the aerodrome traffic zone whether or not it is flying by visual reference to the surface.

(4) *Precision Approach Radar Control Rating* shall entitle the holder of the licence, at any aerodrome for which the rating is valid, to provide air traffic control service with the aid of any type of precision approach radar equipment for which the rating is valid.

(5) *Area Control Rating* shall entitle the holder of the licence at any place for which the rating is valid to provide an air traffic control service without the aid of any surveillance radar equipment.

(6) *Area Radar Control Rating* shall entitle the holder of the licence, at any place for which the rating is valid, to provide air traffic control service with the aid of any type of surveillance radar equipment for which the rating is valid.

(7) *Area Radar Control (Aerodrome) Rating* shall entitle the holder of the licence, at any aerodrome for which the rating is valid, to provide air traffic control service with the aid of any type of surveillance radar equipment for which the rating is valid.

SCHEDULE 11

PUBLIC TRANSPORT—OPERATIONAL REQUIREMENTS

Article 25

PART A

—OPERATIONS MANUAL

Information and instructions relating to the following matters shall be included in the operations manual referred to in Article 25(2) of this Order:

- (i) the number of the crew to be carried in the aircraft, on each stage of any route to be flown, and the respective capacities in which they are to act, and instructions as to the order and circumstances in which command is to be assumed by members of the crew;
- (ii) the respective duties of each member of the crew and the other members of the operating staff;
- (iii) the scheme referred to in Article 54(1)(c)(i) of this Order;
- (iv) such technical particulars concerning the aircraft, its engines and equipment and concerning the performance of the aircraft as may be necessary to enable the flight crew of the aircraft to perform their respective duties;
- (v) the manner in which the quantities of fuel and oil to be carried by the aircraft are to be computed and records of fuel and oil carried and consumed on each stage of the route to be flown are to be maintained; the instructions shall take account of all circumstances likely to be encountered on the flight including the possibility of failure of one or more of the aircraft engines;
- (vi) the manner in which the quantity, if any, of oxygen equipment to be carried in the aircraft for the purpose of complying with Scales L1 and L2 in Schedule 5 to this Order is to be computed;
- (vii) the check system to be followed by the crew of the aircraft prior to and on take-off, on landing and in an emergency, so as to ensure that the operating procedures contained in the operations manual and in the flight manual or performance schedule forming part of the relevant certificate of airworthiness are complied with;
- (viii) the circumstances in which a radio watch is to be maintained;

Status: This is the original version (as it was originally made). This item of legislation is currently only available in its original format.

- (ix) the circumstances in which oxygen is to be used by the crew of the aircraft, and by passengers;
- (x) communication, navigational aids, aerodromes, local regulations, in-flight procedures, approach and landing procedures and such other information as the operator may deem necessary for the proper conduct of flight operations; the information referred to in this paragraph shall be contained in a route guide, which may be in the form of a separate volume;
- (xi) the reporting in flight to the notified authorities of meteorological observations;
- (xii) the minimum altitudes for safe flight on each stage of the route to be flown and any planned diversion therefrom, such minimum altitudes being not lower than any which may be applicable under the law of Hong Kong or of the countries whose territory is to be flown over;
- (xiii) the particulars referred to in Article 30 of this Order;
- (xiv) emergency flight procedures, including procedures for the instruction of passengers in the position and use of emergency equipment and procedures to be adopted when the commander of the aircraft becomes aware that another aircraft or vessel is in distress and needs assistance;
- (xv) in the case of aircraft intended to fly at an altitude of more than 49,000 feet the procedures for the use of cosmic radiation detection equipment;
- (xvi) the labelling and marking of dangerous goods, the manner in which they must be loaded on an aircraft and the responsibilities of members of the crew in respect of the carriage of dangerous goods:

Provided that in relation to any flight which is not one of a series of flights between the same two places it shall be sufficient if, to the extent that it is not practicable to comply with paragraphs (x) and (xii), the manual contains such information and instructions as will enable the equivalent data to be ascertained before take-off.

Article 27

PART B

—CREW TRAINING AND TESTS

1. The training, experience, practice and periodical tests required under Article 27(2) of this Order in the case of members of the crew of an aircraft engaged on a flight for the purpose of public transport shall be as follows:

(1) *The Crew*

Every member of the crew shall—

- (a) have been tested within the relevant period by or on behalf of the operator as to his knowledge of the use of the emergency and life saving equipment required to be carried in the aircraft on the flight; and
- (b) have practised within the relevant period under the supervision of the operator or of a person appointed by him for the purpose, the carrying out of the duties required of him in case of an emergency occurring to the aircraft, either in an aircraft of the type to be used on the flight or in apparatus approved by the Governor for the purpose and controlled by persons so approved.

(2) *Pilots*

- (a) Every pilot included in the flight crew who is intended by the operator to fly as pilot in circumstances requiring compliance with the Instrument Flight Rules shall within the relevant period have been tested by or on behalf of the operator—

Status: This is the original version (as it was originally made). This item of legislation is currently only available in its original format.

- (i) as to his competence to perform his duties while executing normal manoeuvres and procedures in flight, in an aircraft of the type to be used on the flight including the use of the instruments and equipment provided in the aircraft;
- (ii) as to his competence to perform his duties in instrument flight conditions while executing emergency manoeuvres and procedures in flight, in an aircraft of the type to be used on the flight, including the use of the instruments and equipment provided in the aircraft.

A pilot's ability to carry out normal manoeuvres and procedures shall be tested in the aircraft in flight.

The other tests required by this sub-paragraph may be conducted either in the aircraft in flight, or under the supervision of a person approved by the Governor for the purpose by means of a flight simulator approved by the Governor under Article 20(10) of this Order. The tests specified in sub-paragraph (2)(a)(ii) of this paragraph when conducted in the aircraft in flight shall be carried out either in actual instrument flight conditions or in instrument flight conditions simulated by means approved by the Governor.

- (b) Every pilot included in the flight crew whose licence does not include an instrument rating or who, notwithstanding the inclusion of such a rating in his licence, is not intended by the operator to fly in circumstances requiring compliance with the Instrument Flight Rules, shall within the relevant period have been tested, by or on behalf of the operator, in flight in an aircraft of the type to be used on the flight—
 - (i) as to his competence to act as pilot thereof, while executing normal manoeuvres procedures, and
 - (ii) as to his competence to act as pilot thereof while executing emergency manoeuvres and procedures.
- (c) Every pilot included in the flight crew who is seated at the flying controls during take-off or landing shall within the relevant period—
 - (i) have been tested as to his proficiency using instrument approach-to-land systems of the type in use at the aerodromes of intended landing and any alternative aerodromes, such test being carried out either in flight in instrument flight conditions or in instrument flight conditions simulated by means approved by the Governor or under the supervision of a person approved by the Governor for the purpose by means of a flight simulator approved by the Governor, and
 - (ii) have carried out when seated at the flying controls not less than three take-offs and three landings in aircraft of the type to be used on the flight.

(3) *Flight Engineers*

Every flight engineer included in the flight crew shall within the relevant period have been tested by or on behalf of the operator—

- (a) as to his competence to perform his duties while executing normal procedures in flight, in an aircraft of the type to be used on the flight.
- (b) as to his competence to perform his duties while executing emergency procedures in flight, in an aircraft of the type to be used on the flight.

A flight engineer's ability to carry out normal procedures shall be tested in an aircraft in flight. The other tests required by this sub-paragraph may be conducted either in the aircraft in flight, or under supervision of a person approved by the Governor for the purpose by means of a flight simulator approved by the Governor.

(4) *Flight Navigators and Flight Radio Operators*

Status: This is the original version (as it was originally made). This item of legislation is currently only available in its original format.

Every flight navigator and flight radio operator whose inclusion in the flight crew is required under Article 18(4) and (5) respectively of this Order shall with the relevant period have been tested by or on behalf of the operator as to his competence to perform his duties in conditions corresponding to those likely to be encountered on the flight—

- (a) in the case of a flight navigator, using equipment of the type to be used in the aircraft on the flight for purposes of navigation;
- (b) in the case of a flight radio operator, using radio equipment of the type installed in the aircraft to be used on the flight, and including a test of his ability to carry out emergency procedures.

(5) *Aircraft Commanders*

- (a) The pilot designated as commander of the aircraft for the flight shall within the relevant period have demonstrated to the satisfaction of the operator that he has adequate knowledge of the route to be taken, the aerodromes of take-off and landing, and any alternate aerodromes, including in particular his knowledge of—

- (i) the terrain;
- (ii) the seasonal meteorological conditions;
- (iii) the meteorological communications, and air traffic facilities, services and procedures; and
- (iv) the search and rescue procedures, and the navigational facilities, relevant to the route.

- (b) In determining whether a pilot's knowledge of the matters referred to in sub-paragraph (a) is sufficient to render him competent to perform the duties of aircraft commander on the flight, the operator shall take into account the pilot's flying experience in conjunction with the following—

- (i) the experience of other members of the intended flight crew;
- (ii) the influence of terrain and obstructions on departure and approach procedures at the aerodromes of take-off and intended landing and at alternate aerodromes;
- (iii) the similarity of the instrument approach procedures and let-down aids to those with which the pilot is familiar;
- (iv) the dimensions of runways which may be used in the course of the flight in relation to the performance limits of aircraft of the type to be used on the flight;
- (v) the reliability of meteorological forecasts and the probability of difficult meteorological conditions in the areas to be traversed;
- (vi) the adequacy of the information available regarding the aerodrome of intended landing and any alternate aerodromes;
- (vii) the nature of air traffic control procedures and familiarity of the pilot with such procedures;
- (viii) the influence of terrain on route conditions and the extent of the assistance obtainable en-route from navigational aids and air-to-ground communication facilities; and
- (ix) the extent to which it is possible for the pilot to become familiar with unusual aerodrome procedures and features of the route by means of ground instruction and training devices.

- (6) For the purposes of this paragraph—

“instrument flight conditions” means weather conditions such that the pilot is unable to fly by visual reference to objects outside the aircraft;

“relevant period” means a period which immediately precedes the commencement of the flight, being a period—

Status: This is the original version (as it was originally made). This item of legislation is currently only available in its original format.

- (a) in the case of sub-paragraph (2)(c)(ii) of this paragraph, of 3 months;
- (b) in the case of sub-paragraphs (2)(a)(ii), (2)(b)(ii), (2)(c)(i) and (3)(b) of this paragraph, of 6 months;
- (c) in the case of sub-paragraphs (1), (2)(a)(i), (2)(b)(i), (3)(a), (4) and (5)(a) of this paragraph, of 13 months:

Provided that—

- (i) any pilot of the aircraft to whom the provisions of sub-paragraphs (2)(a)(ii), (2)(b)(ii) or (2)(c)(i) and any flight engineer of the aircraft to whom the provisions of sub-paragraph (3)(b) of this paragraph apply shall for the purposes of the flight be deemed to have complied with such requirement respectively within the relevant period if he has qualified to perform his duties in accordance therewith on two occasions within the period of 13 months immediately preceding the flight, such occasions being separated by an interval of not less than 4 months;
- (ii) the requirements of sub-paragraph (5)(a) shall be deemed to have been complied with within the relevant period by a pilot designated as commander of the aircraft for the flight if, having become qualified so to act on flights between the same places over the same route more than 13 months before commencement of the flight, he has within the period of 13 months immediately preceding the flight flown as pilot of an aircraft between those places over the route.

2.—(1) The records required to be maintained by an operator under Article 27(2) of this Order shall be accurate and up-to-date records so kept as to show, on any date, in relation to each person who has during the period of two years immediately preceding that date flown as a member of the crew of any public transport aircraft operated by that operator—

- (a) the date and particulars of each test required by this Schedule undergone by that person during the said period including the name and qualifications of the examiner;
- (b) the date upon which the person last practised the carrying out of duties referred to in paragraph 1(1)(b) of this Schedule;
- (c) the operator's conclusions based on each such test and practice as to that person's competence to perform his duties;
- (d) the date and particulars of any decision taken by the operator during the said period in pursuance of paragraph 1(5)(a) of this Schedule including particulars of the evidence upon which that decision was based.

(2) The operator shall whenever called upon to do so by any authorised person produce for the inspection of any person so authorised all records referred to in the preceding sub-paragraphs and furnish to any such person all such information as he may require in connection with any such records and produce for his inspection all log books, certificates, papers and other documents, whatsoever which he may reasonably require to see for the purpose of determining whether such records are complete or of verifying the accuracy of their contents.

(3) The operator shall at the request of any person in respect of whom he is required to keep records as aforesaid furnish to that person, or to any operator of aircraft for the purpose of public transport by whom that person may subsequently be employed, particulars of any qualifications in accordance with this Schedule obtained by such person whilst in his service.

Status: This is the original version (as it was originally made). This item of legislation is currently only available in its original format.

PART C

—TRAINING MANUAL

The following information and instructions in relation to the training, experience, practice and periodical tests required under Article 27(2) of this Order shall be included in the training manual referred to in Article 26(2) of this Order—

- (i) the manner in which the training, practice and periodical tests required under Article 27(2) and specified in Part B of Schedule 11 to this Order are to be carried out;
- (ii) (a) the minimum qualifications and experience which the operator requires of persons appointed by him to give or to supervise the said training, practice and periodical tests; and
(b) the type of training, practice and periodical tests which each such person is appointed to give or to supervise; and
(c) the type of aircraft in respect of which each such person is appointed to give or to supervise the said training, practice and periodical tests;
- (iii) the minimum qualifications and experience required of each member of the crew undergoing the said training, practice and periodical tests;
- (iv) the syllabus for, and specimen forms for recording, the said training, practice and periodical tests;
- (v) the manner in which instrument flight conditions and engine failure are to be simulated in the aircraft in flight;
- (vi) the extent to which the said training and testing is permitted in the course of flights for the purpose of public transport;
- (vii) the use to be made in the said training and testing of apparatus approved for the purpose by the Governor.

SCHEDULE 12

Articles 57 and 59

DOCUMENTS TO BE CARRIED BY AIRCRAFT REGISTERED IN HONG KONG

On a flight for the purpose of public transport:

Documents A, B, C, D, E, F, H and, if the flight is international air navigation, Document G.

On a flight for the purpose of aerial work:

Documents A, B, C, E, F and, if the flight is international air navigation, Document G.

On a flight, being international air navigation for a purpose other than public transport of aerial work:

Documents A, B, C and G.

For the purposes of this Schedule:

“A” means the licence in force in respect of the aircraft radio station installed in the aircraft, and the current telecommunication log book required by this Order;

“B” means the certificate of airworthiness in force in respect of the aircraft:

Provided that, with the permission in writing of the Governor, an aircraft to which Article 25 of this Order applies need not carry the flight manual as part of this document if it carries an operations manual which includes—

- (i) the information shown in the Limitations and Emergency Procedures section of the flight manual, and

- (ii) performance instructions which are derived from the material contained in the performance section of the flight manual.
- “C” means the licences of the members of the flight crew of the aircraft;
- “D” means one copy of the load sheet, if any, required by Article 28 of this Order in respect of the flight;
- “E” means one copy of each certificate of maintenance review, if any, in force in respect of the aircraft;
- “F” means the technical log, if any, in which entries are required to be made under Article 10;
- “G” means the certificate of registration in force in respect of the aircraft;
- “H” means the operations manual, if any, required by Article 25(2)(a)(iii) of this Order to be carried out on the flight;
- “International air navigation” means any flight which includes passage over the territory of any country other than Hong Kong.

SCHEDULE 13

Article 91

PART A

—PROVISIONS REFERRED TO IN ARTICLE 91(5)

Article of Order	Subject Matter
3	Aircraft flying unregistered
5	Aircraft flying with false or incorrect markings
9(1)(a)	Flight without appropriate maintenance
9(1)(b)	Flight without a certificate of maintenance review
10	Failure to keep technical log
11	Flight without a certificate of release to service
13	Flight without required equipment
14	Flight without required radio equipment
15	Failure to keep log book
16	Requirement to weigh aircraft and keep weight schedule
18	Crew requirement
19	Requirement for appropriate licence
20(4) and (5)	Requirement for appropriate certificates
20(6)	Prohibition of flight after failure of test
20(7)(a)	Flight without valid medical certificate
20(8)	Flight in unfit condition

Status: This is the original version (as it was originally made). This item of legislation is currently only available in its original format.

Article of Order	Subject Matter
23	Instruction in flying without appropriate licence and rating
25	Operations manual requirement
26	Training manual requirement
27	Operator's responsibilities in connection with crew
28	Requirements for loading aircraft
29	Operational restrictions on aircraft
30	Aerodrome operating minima—aircraft registered in Hong Kong
31	Aerodrome operating minima—foreign registered aircraft
31A	Non-public transport aircraft—aerodrome operating minima
32	Pre-flight action by commander of aircraft
33	Requirement for pilot to remain at controls
34	Duties of commander on flight for public transport of passengers
35	Requirements for radio station in aircraft to be licensed and for operation of same
36	Requirement for minimum navigation performance system
37	Use of flight recorders and preservation of records
38	Towing of gliders
39	Towing, picking-up and raising of persons and articles by aircraft
40 and 41	Dropping of persons, animals and articles from aircraft
42	Requirement for aerial application certificate
45	Carriage of persons in or on any part of an aircraft not designed for that purpose
46	Requirement for exits and break-in markings
50	Prohibition of smoking in aircraft
51	Requirement to obey lawful commands of aircraft commander
52	Prohibition of stowaways
54(3)	Operator's obligation to obtain flight time records of flight crew

Article of Order	Subject Matter
55(2)	Flight crew member's obligation to inform operator of flight times
56	Flight time limitations
64(2)	Breach of Rules of the Air
66 (except (4))	Requirement for licensing of air traffic controllers and aerodrome flight information service officers
67	Requirement for aerodrome information service manual
69	Flight in contravention of restriction of flying regulations
70	Flight by balloons, kites, airships, gliders and parascending parachutes
71	Requirement for licensed aerodrome
73(5)	Contravention of condition of aerodrome licence
74	Use of radio equipment at aerodromes
75	Requirement to keep records at aerodrome
79	Use of aeronautical lights
80(1)	Prohibition of dangerous lights
80(2)	Failure to extinguish or screen dangerous lights
82(1) and (2)	Management of aviation fuel at aerodromes
86 (except (4))	Requirement to report occurrences
89	Obstruction of persons performing duties under Order

PART B

—PROVISIONS REFERRED TO IN ARTICLE 91(6)

Article of Order	Subject Matter
6	Flight for the purpose of public transport without an air operator's certificate
7	Flight without a certificate of airworthiness
43	Prohibition of carriage of weapons and munitions of war
44	Prohibition of carriage of dangerous goods
47	Endangering safety of aircraft
48	Endangering safety of persons or property

Status: This is the original version (as it was originally made). This item of legislation is currently only available in its original format.

Article of Order	Subject Matter
49	Prohibition of drunkenness in aircraft
54(1)	Operator's obligation to regulate flight times of flight crew
54(2)	Operator's obligations not to allow flight by crew in dangerous state of fatigue
55(1)	Crew's obligation not to fly in dangerous state of fatigue
63 (except (3))	Use of false or unauthorised documents and records
82(3)	Use of aviation fuel which is unfit for use in aircraft
84	Restriction of flights for aerial photography and survey by aircraft registered outside the Territory
85	Operator's or commanders' obligations in respect of flights over any foreign country
86(4)	Making false reports
87	Flight in contravention of direction not to fly

SCHEDULE 14

Article 64

RULES OF THE AIR

SECTION I

INTERPRETATION

1. In these Rules, unless the context otherwise requires—

“Air traffic control clearance” means authorisation by an air traffic control unit for an aircraft to proceed under conditions specified by that unit.

“Anti-collision light” means

- (a) in relation to rotorcraft a flashing red light;
- (b) in relation to any other aircraft a flashing red or flashing white lights:

and in either case showing in all directions for the purpose of enabling the aircraft to be more readily detected by the pilots of distant aircraft.

“Apron” means the part of an aerodrome provided for the stationing of aircraft for the embarkation and disembarkation of passengers, the loading and unloading of cargo and parking.

“Ground visibility” means the horizontal visibility at ground level.

“IFR flight” means a flight conducted in accordance with the Instrument Flight Rules in Section VI of these Rules.

“Manoeuvring area” means the part of an aerodrome provided for the take-off and landing of aircraft and the movement of aircraft on the surface, excluding the apron and any part of the aerodrome provided for the maintenance of aircraft.

“Runway” means an area, whether or not paved, which is provided for the take-off or landing run of aircraft.

“VFR Flight” means a flight conducted in accordance with the Visual Flight Rules in Section V of these Rules.

SECTION II

GENERAL

Application of Rules to Aircraft

2. These Rules, in so far as they are applicable in relation to aircraft, shall, subject to the provisions of Rule 29 of these Rules, apply in relation to—

- (a) all aircraft within Hong Kong; and
- (b) all aircraft registered in Hong Kong wherever they may be.

Misuse of Signals and Markings

3.—(1) A signal or marking to which a meaning is given by these Rules, or which is required by these Rules to be used in circumstances or for a purpose therein specified, shall not be used except with that meaning, or for that purpose.

(2) A person in an aircraft or on an aerodrome or at any place at which an aircraft is taking off or landing shall not make any signal which may be confused with a signal specified in the Rules and, except with lawful authority, shall not make any signal which he knows or ought reasonably to know to be a signal in use for signalling to or from any of Her Majesty’s naval, military or air force aircraft.

Reporting hazardous conditions

4. The commander of an aircraft shall, on meeting with hazardous conditions in the course of a flight, or as soon as possible thereafter, send to the appropriate air traffic control unit by the quickest means available information containing such particulars of the hazardous conditions as may be pertinent to the safety of other aircraft.

Low flying

5.—(1) Subject to the provisions of paragraph (2) and (3) of this Rule:

- (a) An aircraft other than a helicopter shall not fly over any congested area of a city, town or settlement below—
 - (i) such height as would enable the aircraft to alight clear of the area and without danger to persons or property on the surface, in the event of failure of a power unit and if such an aircraft is towing a banner such height shall be calculated on the basis that the banner shall not be dropped within the congested area; or
 - (ii) a height of 1500 feet above the highest fixed object within 2000 feet of the aircraft, whichever is the higher.
- (b) A helicopter shall not fly below such height as would enable it to alight without danger to persons or property on the surface, in the event of failure of a power unit.
- (c) Except with the permission in writing of the Governor and in accordance with any conditions therein specified a helicopter should not fly over a congested area of a city,

Status: This is the original version (as it was originally made). This item of legislation is currently only available in its original format.

town or settlement below a height of 1500 feet above the highest fixed object within 2000 feet of the helicopter.

- (d) An aircraft shall not fly—
- (i) over, or within 3000 feet of, any assembly in the open air of more than 1000 persons assembled for the purpose of witnessing or participating in any organised event, except with the permission in writing of the Governor and in accordance with any conditions therein specified and with the consent in writing of the organisers of the event; or
 - (ii) below such height as would enable it to alight clear of the assembly in the event of the failure of a power unit and if such an aircraft is towing a banner such height shall be calculated on the basis that the banner shall not be dropped within 3000 feet of the assembly:

Provided that, where a person is charged with an offence under this Order by reason of a contravention of this sub-paragraph, it shall be a good defence to prove that the flight of the aircraft over, or within 3000 feet of, the assembly was made at a reasonable height and for a reason not connected with the assembly or with the event which was the occasion for the assembly.

- (e) An aircraft shall not fly closer than 500 feet to any person, vessel, vehicle or structure.
- (a) (2) (a) The provisions of paragraphs (1)(a)(ii) and (1)(c) of this Rule shall not apply to an aircraft flying—
- (i) on a route notified for the purposes of this Rule, or
 - (ii) on a special VFR flight as defined in Rule 23 of these Rules in accordance with instructions given for the purposes of that Rule by the appropriate air traffic control unit.
- (b) Paragraphs (1)(d) and (e) of this Rule shall not apply to an aircraft which is being used for police purposes.
- (c) Paragraphs (1)(d) and (e) of this Rule shall not apply to the flight of an aircraft over or within 3000 feet of an assembly of persons gathered for the purpose of witnessing an event which consists wholly or principally of an aircraft race or contest or an exhibition of flying, if the aircraft is taking part in such race, contest or exhibition or is engaged on a flight arranged by, or made with the consent in writing of, the organisers of the event.
- (d) Paragraph (1)(e) of this Rule shall not apply to—
- (i) any aircraft while it is landing or taking off in accordance with normal aviation practice;
 - (ii) any glider while it is hill-soaring;
 - (iii) any aircraft while it is flying in accordance with proviso (f) of Article 40(2) of this Order;
 - (iv) any aircraft while it is flying in accordance with the terms of an aerial application certificate granted to the operator thereof under Article 42 of this Order;
 - (v) any aircraft while it is flying for the purpose of picking up or dropping tow ropes, banners or similar articles at an aerodrome in accordance with article 39(2) or proviso (e) of article 40(2) of this Order.
- (3) Nothing in this Rule shall prohibit an aircraft from flying in such a manner as is necessary for the purpose of saving life.
- (4) Nothing in this Rule shall prohibit any aircraft from flying in accordance with normal aviation practice, for the purpose of taking off from, landing at or practising approaches to landing at, or

checking navigational aids or procedures at, a Government aerodrome or a licensed aerodrome in Hong Kong or at any aerodrome elsewhere:

Provided that the practising of approaches to landing shall be confined to the airspace customarily used by aircraft when landing or taking off in accordance with normal aviation practice at the aerodrome concerned.

- (5) Nothing in this Rule shall apply to any captive balloon or kite.

Simulated instrument flight

- 6) An aircraft shall not be flown in simulated instrument flight conditions unless—
- (a) the aircraft is fitted with dual controls, which are functioning properly;
 - (b) an additional pilot (in this Rule called “a safety pilot”) is carried in a second control seat of the aircraft for the purpose of rendering such assistance as may be necessary to the pilot of the aircraft; and
 - (c) if the safety pilot’s field of vision is not adequate both forward and to each side of the aircraft, a third person, being a competent observer, occupies a position in the aircraft which from his field of vision makes good the deficiencies in that of the safety pilot, and from which he can readily communicate with the safety pilot.

For the purposes of this Rule the expression “simulated instrument flight” means a flight during which mechanical or optical devices are used in order to reduce the field of vision or the range of visibility from the cockpit of the aircraft.

Practice Instrument Approaches

- 7) Within Hong Kong an aircraft shall not carry out instrument approach practice when flying in Visual Meteorological Conditions unless—
- (a) the appropriate air traffic control unit has previously been informed that the flight is to be made for the purpose of instrument approach practice; and
 - (b) if the flight is not being carried out in simulated instrument flight conditions, a competent observer is carried in such a position in the aircraft that he has an adequate field of vision and can readily communicate with the pilot flying the aircraft.

SECTION III

LIGHTS AND OTHER SIGNALS TO BE SHOWN OR MADE BY AIRCRAFT

GENERAL

8.—(1) For the purposes of this Section of these Rules the horizontal plane of light shown in an aircraft means the plane which would be the horizontal plane passing through the source of that light, if the aircraft were in level flight.

(2) Where by reason of the physical construction of an aircraft it is necessary to fit more than one lamp in order to show a light required by this Section of these Rules, the lamps shall be so fitted and constructed that, so far as is reasonably practicable, not more than one such lamp is visible from any one point outside the aircraft.

(3) Where in these Rules a light is required to show through specified angles in the horizontal plane, the lamps giving such light shall be so constructed and fitted that the light is visible from any point in any vertical plane within those angles throughout angles of 90 degrees above and below the horizontal plane, but, so far as is reasonably practicable, through no greater angle, either in the horizontal plane or the vertical plane.

Status: This is the original version (as it was originally made). This item of legislation is currently only available in its original format.

(4) Where in these Rules a light is required to show in all directions, the lamps giving such light shall be so constructed and fitted that, so far as is reasonably practicable, the light is visible from any point in the horizontal plane and on any vertical plane passing through the source of that light.

Display of lights by aircraft

- (a) **9.** (1) (a) By night an aircraft shall display such of the lights specified in these Rules as may be appropriate to the circumstances of the case, and shall not display any other lights which might obscure or otherwise impair the visibility of, or be mistaken for, such lights.
- (b) By day an aircraft fitted with an anti-collision light shall display such a light in flight.
- (2) A flying machine on an aerodrome in Hong Kong shall:
 - (a) display by night either the lights which it would be required to display when flying or the lights specified in Rule 11(2)(c) of these Rules unless it is stationary on the apron or part of the aerodrome provided for the maintenance of aircraft;
 - (b) display when stationary on the apron by day or night with engines running a red anti-collision light, if fitted:

Provided that a helicopter to which Article 25 of the Order applies may, when stationary on an offshore installation, switch off such an anti-collision light in accordance with a procedure contained in the operations manual of the helicopter as a signal to ground personnel that it is safe to approach the helicopter for the purpose of embarkation or disembarkation of passengers or the loading or unloading of cargo.

(3) Notwithstanding the provisions of this section of the Rules the commander of an aircraft may switch off or reduce the intensity of any flashing light fitted to the aircraft if such a light does or is likely to:

- (a) adversely affect the performance of the duties of any member of the flight crew; or
- (b) subject an outside observer to unreasonable dazzle:

Failure of navigation and anti-collision lights

10.—(1) In Hong Kong, in the event of the failure of any light which is required by these Rules to be displayed at night, if the light cannot be immediately repaired or replaced the aircraft shall not depart from the aerodrome and, if in flight, shall land as soon as in the opinion of the commander of the aircraft it can safely do so, unless authorised by the appropriate air traffic control unit to continue its flight.

(2) In Hong Kong, in the event of a failure of an anti-collision light when flying by day, an aircraft may continue to fly by day provided that the light is repaired at the earliest practicable opportunity.

Flying Machines

- 11.**—(1) A flying machine when flying at night shall display light as follows:—
 - (a) in the case of a flying machine registered in Hong Kong having a maximum total weight authorised of more than 5,700 kg or any other flying machine registered in Hong Kong which conforms to a type first issued with a type certificate on or after 1st January 1991 the system of lights in paragraph (2)(b) of this rule;
 - (b) in the case of a flying machine registered in Hong Kong which conforms to a type first issued with a type certificate before 1st January 1991 having a maximum total weight authorised of 5,700 kg or less, any one of the following systems of lights:—
 - (i) that specified in paragraph (2)(a) of this Rule, or that specified in paragraph (2)(b); or
 - (ii) that specified in paragraph (2)(d), excluding sub-paragraph (ii);

(c) in the case of any other flying machines one of the systems of lights specified in paragraph (2) of this Rule.

(2) The systems of lights referred to in paragraph (1) of this Rule are as follows:—

- (a) (i) a steady green light of at least five candela showing to the starboard side through an angle of 100 degrees from dead ahead in the horizontal plane; and
- (ii) a steady red light of at least five candela showing to the port side through an angle of 100 degrees from dead ahead in the horizontal plane; and
- (iii) a steady white light of at least three candela showing through angles of 70 degrees from dead astern to each side in the horizontal plane;
- (b) (i) the lights specified in sub-paragraph (a) of this paragraph; and
- (ii) an anti-collision light;
- (c) the lights specified in sub-paragraph (a) of this paragraph, but all being flashing lights flashing together;
- (d) the lights specified in sub-paragraph (a), but all being flashing lights flashing together in alternation with one or both of the following:
 - (i) a flashing white light of at least twenty candela showing in all directions;
 - (ii) a flashing red light of at least twenty candela showing through angles of 70 degrees from dead astern to each side in the horizontal plane.

(3) If the lamp showing either the red or green light specified in paragraph (2)(a) of this Rule is fitted more than 2 metres from the wing tip, a lamp may, notwithstanding the provisions of Rule 9(1) of these Rules, be fitted at the wing tip to indicate its position showing a steady light of the same colour through the same angle.

Gliders

12. A glider while flying at night shall display either a steady red light of at least five candela showing in all directions, or lights in accordance with Rule 11(2) and (3) of these Rules.

Free Balloons

13. A free balloon while flying at night shall display a steady red light of at least five candela showing in all directions, suspended not less than 5 metres and not more than 10 metres below the basket, or if there is no basket, below the lowest part of the balloon.

Captive balloons and kites

14.—(1) A captive balloon or kite while flying at night at a height exceeding 60 metres above the surface shall display lights as follows:—

- (a) a group of two steady lights consisting of a white light placed 4 metres above a red light, both being of at least five candela and showing in all directions, the white light being placed not less than 5 metres or more than 10 metres below the basket, or if there is no basket, below the lowest part of the balloon or kite;
- (b) on the mooring cable, at intervals of not more than 300 metres measured from the group of lights referred to in sub-paragraph (a) of this paragraph, groups of two lights of the colour and power and in the relative positions specified in that sub-paragraph, and, if the lowest group of lights is obscured by cloud, an additional group below the cloud base; and
- (c) on the surface, a group of three flashing lights arranged in a horizontal plane at the apexes of a triangle, approximately equilateral, each side of which measures at least 25 metres; one side of the triangle shall be approximately at right angles to the horizontal projection

Status: This is the original version (as it was originally made). This item of legislation is currently only available in its original format.

of the cable and shall be delimited by two red lights; the third light shall be a green light so placed that the triangle enclose the object on the surface to which the balloon or kite is moored.

(2) A captive balloon while flying by day at a height exceeding 60 metres above the surface shall have attached to its mooring cable at intervals of not more than 200 metres measured from the basket, or, if there is no basket, from the lowest part of the balloon, tubular streamers not less than 40 centimetres in diameter and 2 metres in length, and marked with alternative bands of red and white 50 centimetres wide.

(3) A kite flown in the circumstances referred to in paragraph (2) of this Rule shall have attached to its mooring cable either:—

- (a) tubular streamers as specified in paragraph (2) of this Rule, or
- (b) at intervals of not more than 100 metres measured from the lowest part of the kite, streamers of not less than 80 centimetres long and 30 centimetres wide at their widest point and marked with alternate bands of red and white 10 centimetres wide.

Airships

15.—(1) Except as provided in paragraph (2) of this Rule, an airship while flying at night shall display the following:—

- (a) a steady white light of at least five candela showing through angles of 110 degrees from dead ahead to each side in the horizontal plane;
- (b) a steady green light of at least five candela showing to the starboard side through an angle of 110 degrees from dead ahead in the horizontal plane;
- (c) a steady red light of at least five candela showing to the port side through an angle of 110 degrees from dead ahead in the horizontal plane;
- (d) a steady white light of at least five candela showing through angles of 70 degrees from dead astern to each side in the horizontal plane; and
- (e) an anti-collision light.

(2) An airship while flying at night shall display, if it is not under command, or has voluntarily stopped its engines, or is being towed, the following steady lights:—

- (a) the white lights referred to in paragraph (1)(a) and (d) of this Rule;
- (b) two red lights, each of at least five candela and showing in all directions suspended below the control car so that one is at least 4 metres above the other and at least 8 metres below the control car; and
- (c) if the airship is making way but not otherwise, the green and red lights referred to in paragraph (1)(b) and (c) of this Rule:

Provided that an airship while picking up its moorings, notwithstanding that this is not under command, shall display only the lights specified in paragraph (1) of this Rule.

(3) An airship, while moored within Hong Kong by night, shall display the following steady lights:

- (a) when moored to a mooring mast, at or near the rear a white light of at least five candela showing in all directions;
- (b) when moored otherwise than to a mooring mast:—
 - (i) a white light of at least five candela showing through angles of 110 degrees from dead ahead to each side in the horizontal plane;
 - (ii) a white light of at least five candela showing through angles of 70 degrees from dead astern to each side in the horizontal plane.

(4) An airship while flying by day, if it is not under command, or has voluntarily stopped its engines, or is being towed, shall display two black balls suspended below the control car so that one is at least 4 metres above the other and at least 8 metres below the control car.

(5) For the purposes of this Rule:—

- (a) an airship shall be deemed not to be under command when it is unable to execute a manoeuvre which it may be required to execute by or under these Rules;
- (b) an airship shall be deemed to be making way when it is not moored and is in motion relative to the air.

SECTION IV

GENERAL FLIGHT RULES

Weather reports and forecasts

16.—(1) Immediately before an aircraft flies the commander of the aircraft shall examine the current reports and forecasts of the weather conditions on the proposed flight path, being reports and forecasts which it is reasonably practicable for him to obtain, in order to determine whether Instrument Meteorological Conditions prevail or are likely to prevail during any part of the flight.

(2) An aircraft which is unable to communicate by radio with an air traffic control unit at the aerodrome of destination shall not begin a flight to an aerodrome within a control zone if the information which it is reasonably practicable for the commander of the aircraft to obtain indicates that it will arrive at that aerodrome when the ground visibility is less than 5 nautical miles or the cloud ceiling is less than 1,500 feet, unless the commander of the aircraft has obtained from an air traffic control unit at that aerodrome permission to enter the aerodrome traffic zone.

Rules for avoiding aerial collisions

17.—(1) General

- (a) Notwithstanding that the flight is being made with air traffic control clearance it shall remain the duty of the commander of an aircraft to take all possible measures to ensure that his aircraft does not collide with any other aircraft.
- (b) An aircraft shall not be flown in such proximity to other aircraft as to create a danger of collision.
- (c) Aircraft shall not fly in formation unless the commanders of the aircraft have agreed to do so.
- (d) An aircraft which is obliged by these Rules to give way to another aircraft shall avoid passing over or under the other aircraft, or crossing ahead of it, unless passing well clear of it.
- (e) An aircraft which has the right-of-way under this Rule shall maintain its course and speed.
- (f) For the purposes of this Rule a glider and a flying machine which is towing it shall be considered to be a single aircraft under the command of the commander of the towing flying machine.

(2) *Converging*

- (a) Subject to the provision of paragraphs (3) and (4) of this Rule, an aircraft in the air shall give way to other converging aircraft as follows:—
 - (i) flying machines shall give way to airships, gliders and balloons;
 - (ii) airships shall give way to gliders and balloons;
 - (iii) gliders shall give way to balloons.

Status: This is the original version (as it was originally made). This item of legislation is currently only available in its original format.

- (b) Subject to the provisions of sub-paragraph (a) of this paragraph, when two aircraft are converging in the air at approximately the same altitude, the aircraft which has the other on its right shall give way:

Provided that mechanically driven aircraft shall give way to aircraft which are towing other aircraft or objects.

(3) *Approaching head-on*

When two aircraft are approaching head-on or approximately so in the air and there is danger of collision, each shall alter its course to the right.

(4) *Overtaking*

An aircraft which is being overtaken in the air shall have the right-of-way and the overtaking aircraft, whether climbing, descending or in horizontal flight, shall keep out of the way of the other aircraft by altering course to the right, and shall not cease to keep out of the way of the other aircraft until that other aircraft has been passed and is clear, notwithstanding any change in the relative positions of the two aircraft:

Provided that a glider overtaking another glider in Hong Kong may alter its course to the right or to the left.

(5) *Flight in the vicinity of an aerodrome*

Without prejudice to the provision of Rule 35, a flying machine, glider or airship while flying in the vicinity of what the commander of the aircraft knows or ought reasonably to know to be an aerodrome or moving on an aerodrome shall unless, in the case of an aerodrome having an air traffic control unit, that unit otherwise authorises:—

- (a) conform to the pattern of traffic formed by other aircraft intending to land at that aerodrome, or keep clear of the airspace in which the pattern is formed; and
- (b) make all turns to the left unless ground signals otherwise indicate.

(6) *Order of landing*

- (a) An aircraft while landing or on final approach to land shall have the right-of-way over other aircraft in flight or on the ground or water;
- (b) In the case of two or more flying machines, gliders or airships approaching any place for the purpose of landing, the aircraft at the lower altitude shall have the right-of-way, but it shall not cut in front of another aircraft which is in the final approach to land or overtake that aircraft:

Provided that—

- (i) when an air traffic control unit has communicated to any aircraft an order of priority for landing, the aircraft shall approach to land in that order; and
- (ii) when the commander of an aircraft is aware that another aircraft is making an emergency landing, he shall give way to that aircraft, and at night, notwithstanding that he may have received permission to land, shall not attempt to land until he has received further permission to do so.

(7) *Landing and take-off*

- (a) A flying machine, glider or airship shall take-off and land in the direction indicated by the ground signals or, if no such signals are displayed, into the wind, unless good aviation practice demands otherwise.
- (b) A flying machine or glider shall not land on a runway at an aerodrome if the runway is not clear of other aircraft unless, in the case of an aerodrome having an air traffic control unit, that unit otherwise authorises.
- (c) Where take-offs and landings are not confined to a runway—

- (i) a flying machine or glider when landing shall leave clear on its left any aircraft which has landed or is already landing or about to take-off; if such a flying machine or glider is about to turn it shall turn to the left after the commander of the aircraft has satisfied himself that such action will not interfere with other traffic movements; and
 - (ii) a flying machine about to take-off shall take up position and manoeuvre in such a way as to leave clear on its left any aircraft which has already taken-off or is about to take-off.
- (d) A flying machine after landing shall move clear of the landing area as soon as it is possible to do so unless in the case of an aerodrome having an air traffic control unit, that unit otherwise authorises.

Aerobatic manoeuvres

- 18.** An aircraft shall not carry out any aerobatic manoeuvre:
- (a) over a congested area of any city, town or settlement; or
 - (b) within controlled airspace except with the consent of the appropriate air traffic control unit.

Right-hand traffic rule

19. An aircraft which is flying within Hong Kong in sight of the ground and following a road, railway, canal or coastline, or any other line of landmarks, shall keep such line of landmarks on its left:

Provided that this rule shall not apply to an aircraft flying within controlled airspace notified for the purposes of Rule 21 of these Rules in accordance with instructions given by the appropriate air traffic control unit.

Notification of arrival and departure

20.—(1) The commander of an aircraft who has caused notice of its intended arrival at any aerodrome to be given to the air traffic control unit or other authority at that aerodrome shall ensure that the air traffic control unit or other authority at that aerodrome is informed as quickly as possible of any change of intended destination and any estimated delay in arrival of 45 minutes or more.

(2) The commander of an aircraft arriving at or departing from an aerodrome in Hong Kong shall take all reasonable steps to ensure upon landing or prior to departure, as the case may be, that notice of that event be given to the person in charge of the aerodrome, or to the air traffic control unit or aerodrome flight information service unit at the aerodrome.

(3) Without prejudice to the provisions of Rule 27 to these Rules, before taking off on any flight from an aerodrome in Hong Kong, being a flight whose intended destination is more than 40 kilometres from the aerodrome of departure, the commander of an aircraft of which the maximum total weight authorised exceeds 5700 kg shall cause a flight plan containing such particulars of the intended flight as may be necessary for search and rescue purposes to be communicated to the air traffic control unit notified for the purpose of this Rule.

Flight in Class A airspace

21. In relation to flights in Visual Meteorological Conditions in Class A airspace, the commander of an aircraft shall comply with Rules 27 and 28 of these Rules as if the flights were IFR flights:

Provided that the commander of the aircraft shall not elect to continue the flight in compliance with the Visual Flight Rules for the purposes of Rule 27(3).

Status: This is the original version (as it was originally made). This item of legislation is currently only available in its original format.

Choice of VFR or IFR

22. Subject to the provisions of Rule 21 of these Rules an aircraft shall always be flown in accordance with the Visual Flight Rules or the Instrument Flight Rules:

Provided that in Hong Kong an aircraft flying at night:

- (a) outside a control zone shall be flown in accordance with the Instrument Flight Rules; or
- (b) in a control zone shall be flown in accordance with the Instrument Flight Rules unless it is on a Special VFR flight.

Speed Limitations

22A.—(1) Subject to paragraph (3) an aircraft shall not fly below flight level 100 at a speed which according to its air speed indicator is more than 250 knots unless it is flying in accordance with the terms of a written permission of the Governor.

(2) The Governor may grant a permission for the purpose of this Rule subject to such conditions as he thinks fit and either generally or in respect of any aircraft or class of aircraft.

(3) Paragraph (1) shall not apply to:

- (a) flight in Class A airspace;
- (b) flight in Class B airspace;
- (c) IFR flight in Class C airspace;
- (d) VFR flight in Class C airspace or VFR flight or IFR flight in class D airspace when authorised by the appropriate air traffic control unit;
- (e) the flight of an aircraft flying in accordance with the “A Conditions” or the “B Conditions” set forth in Schedule 2 to the Ordinance, when authorised by the appropriate air traffic control unit.

SECTION V

VISUAL FLIGHT RULES

23. The Visual Flight Rules shall be as follows:

- (a) Within Class B airspace:
 - (i) an aircraft flying within Class B airspace at or above flight level 100 shall remain clear of cloud and in a flight visibility of at least 8 kilometres;
 - (ii) an aircraft flying within Class B airspace below flight level 100 shall remain clear of cloud and in a flight visibility of at least 5 kilometres;
- (b) Within Class C, Class D or Class E airspace:
 - (i) an aircraft flying within Class C, Class D or Class E airspace at or above flight level 100 shall remain at least 1,500 metres horizontally and 1,000 feet vertically away from cloud and in a flight visibility of at least 8 kilometres;
 - (ii) an aircraft flying within Class C, Class D or Class E airspace below flight level 100 shall remain at least 1,500 metres horizontally and 1,000 feet vertically away from cloud and in a flight visibility of at least 5 kilometres;
- (c) an aircraft flying outside controlled airspace at or above flight level 100 shall remain at least 1,500 metres horizontally and 1,000 feet vertically away from cloud and in a flight visibility of at least 8 kilometres;
- (d) an aircraft flying outside controlled airspace below flight level 100 shall remain at least 1,500 metres horizontally and 1,000 feet vertically away from cloud and in a flight visibility of at least 5 kilometres;

Provided that this sub-paragraph shall be deemed to be complied with if:

- (i) the aircraft is flying at or below 3,000 feet above mean sea level and remains clear of cloud and in sight of the surface and in a flight visibility of at least 5 kilometres;
- (ii) the aircraft, other than a helicopter, is flying at or below 3,000 feet above mean sea level at a speed which according to its air speed indicator is 140 knots or less and remains clear of cloud and in a flight visibility of at least 1,500 metres; or
- (iii) in the case of a helicopter, the helicopter is flying at or below 3,000 feet above mean sea level flying at a speed, which, having regard to the visibility, is reasonable, and remains clear of cloud and in sight of the surface.

For the purposes of this Rule “Special VFR flight” means a flight made in Instrument Meteorological Conditions or at night in a control zone notified for the purposes of Rule 21 of these Rules in respect of which the appropriate air traffic control unit has given permission for the flight to be made in accordance with special instructions given by that unit instead of in accordance with the Instrument Flight Rules.

VFR Plans and air traffic control clearance

23A.—(1) Unless otherwise specified by the appropriate air traffic control unit before an aircraft flies within Class B, Class C or Class D airspace during the notified hours of watch of the appropriate air traffic control unit, the commander of the aircraft shall cause a flight plan to be communicated to the appropriate air traffic control unit and shall obtain an air traffic control clearance to fly within the said airspace.

(2) The flight plan shall contain such particulars of the flight as may be necessary to enable the air traffic control unit to issue a clearance and for search and rescue purposes.

(3) Whilst flying within the said airspace during the notified hours of watch of the appropriate air traffic control unit the commander of the aircraft shall:

- (a) cause a continuous watch to be maintained on the notified radio frequency appropriate to the circumstances; and
- (b) comply with any instructions which the appropriate air traffic control unit may give in a particular case.

SECTION VI

INSTRUMENT FLIGHT RULES

24. The Instrument Flight Rules shall be as follows:

- (a) Within controlled airspace:

In relation to flights within controlled airspace Rules 25, 27 and 28 shall apply.

- (b) Outside controlled airspace:

In relation to flights outside controlled airspace Rules 25 and 26 shall apply.

Minimum height

25. Without prejudice to the provisions of Rule 5, in order to comply with the Instrument Flight Rules an aircraft shall not fly at a height of less than 1,000 feet above the highest obstacle within a distance of 5 nautical miles of the aircraft unless:

- (a) it is necessary for the aircraft to do so in order to land; or
- (b) the aircraft is flying on a route notified for the purpose of this Rule; or
- (c) the aircraft has been otherwise authorised by the competent authority; or

Status: This is the original version (as it was originally made). This item of legislation is currently only available in its original format.

- (d) the aircraft is flying at an altitude not exceeding 3000 feet above mean sea level and remains clear of cloud and in sight of the surface.

Semi-circular Rule

26. In order to comply with the Instrument Flight Rules, an aircraft when in level flight above 3,000 feet above mean sea level or above the appropriate transition altitude, whichever is the higher, shall be flown at a level appropriate to its magnetic track, in accordance with the appropriate Table set forth in this Rule. The level of flight shall be measured by an altimeter set according to the system published by the competent authority in relation to the area over which the aircraft is flying:

Provided that an aircraft may be flown at a level other than the level required by this Rule if it is flying in conformity with instructions given by an air traffic control unit or in accordance with notified en-route holding patterns or in accordance with holding procedures notified in relation to an aerodrome.

For the purposes of this Rule “transition altitude” means the altitude so notified in relation to flight over such area or areas as may be notified.

TABLE I

—Flights at levels at or below 24,500 feet

<i>Magnetic Track</i>	<i>Cruising Level</i>
Less than 180 degrees	Odd thousands of feet
180 degrees but less than 360 degrees	Even thousands of feet

TABLE II

—Flights at levels above 24,500 feet

<i>Magnetic Track</i>	<i>Cruising Level</i>
Less than 180 degrees	25,000 feet.
	27,000 feet.
	29,000 feet or higher levels at intervals of 4,000 feet.
180 degrees but less than 360 degrees	26,000 feet.
	28,000 feet.
	31,000 feet or higher levels at intervals of 4,000 feet.

Flight plan and air traffic control clearance

27.—(1) In order to comply with the Instrument Flight Rules, before an aircraft either takes off from a point within any controlled airspace or otherwise flies within any controlled airspace the commander of the aircraft shall cause a flight plan to be communicated to the appropriate air traffic control unit and shall obtain an air traffic control clearance based on such flight plan.

(2) The flight plan shall contain such particulars of the intended flight as may be necessary to enable the air traffic control unit to issue an air traffic control clearance, or for search and rescue purposes.

(3) The commander of the aircraft shall fly in conformity with—

- (a) the air traffic control clearance issued for the flight, as amended by any further instructions given by an air traffic control unit; and

Status: This is the original version (as it was originally made). This item of legislation is currently only available in its original format.

(b) the holding and instrument approach procedures notified in relation to the aerodrome of destination, unless he is otherwise authorised by the air traffic control unit there:

Provided that he shall not be required to comply with the foregoing provisions of this paragraph if—

- (i) he is able to fly in uninterrupted Visual Meteorological Conditions for so long as he remains in controlled airspace, and
- (ii) he has informed the appropriate air traffic control unit of his intention to continue the flight in compliance with Visual Flight Rules and has requested that unit to cancel his flight plan.

(4) If for the purpose of avoiding immediate danger any departure is made from the provisions of paragraph (3) of this Rule (as is permitted by Article 64(3) of this Order) the commander of the aircraft shall, in addition to causing particulars to be given in accordance with Article 64(4) of this Order, as soon as possible inform the appropriate air traffic control unit of the deviation.

(5) The commander of the aircraft after he has flown in controlled airspace shall, unless he has requested the appropriate air traffic control unit to cancel his flight plan, forthwith inform that unit when the aircraft lands or leaves the controlled airspace.

Position reports

28. In order to comply with the Instrument Flight Rules the commander of an aircraft in IFR flight who flies in or is intending to enter controlled airspace shall report to the appropriate air traffic control unit the time, and the position and level of the aircraft at such reporting points or at such intervals of time as may be notified for this purpose or as may be directed by the air traffic control unit.

SECTION VII

AERODROME TRAFFIC RULES

Application of aerodrome traffic rules

29. The Rules in this Section of these Rules which are expressed to apply to flying machines shall also be observed, so far as is practicable, in relation to all other aircraft.

Visual signals

30. The commander of a flying machine on, or in the pattern of traffic at, an aerodrome shall observe such visual signals as may be displayed at, or directed to him from, the aerodrome by the authority of the person in charge of the aerodrome and shall obey any instructions which may be given to him by means of such signals:

Provided that he shall not be required to obey the signals referred to in Rule 43 of these Rules (Marshalling Signals) if in his opinion it is inadvisable to do so in the interests of safety.

Movement of aircraft on aerodromes

31. An aircraft shall not taxi on the apron or the manoeuvring area of an aerodrome without the permission of the person in charge of the aerodrome or, where the aerodrome has an air traffic control unit for the time being notified as being on watch, without the permission of that unit.

Access to and movement of persons and vehicles on the aerodrome

32.—(1) A person or vehicle shall not go on to any part of an aerodrome (not being a part of the aerodrome which is a public right of way) without the permission of the person in charge of that part

Status: This is the original version (as it was originally made). This item of legislation is currently only available in its original format.

of the aerodrome, and except in accordance with any conditions subject to which that permission may have been granted.

(2) A vehicle or person shall not go on to or move on the manoeuvring area of an aerodrome having an air traffic control unit without the permission of that unit, and except in accordance with any conditions subject to which that permission may have been granted.

(3) Any permission granted for the purposes of this Rule may be granted whether in respect of persons or vehicles generally, or in respect of any particular person or vehicle or any class of person or vehicle.

Right of way on the ground

33.—(1) This Rule shall apply to:

- (a) flying machines; and
- (b) vehicles;

on any part of a land aerodrome provided for the use of aircraft and under the control of the person in charge of the aerodrome.

(2) Notwithstanding any air traffic control clearance it shall remain the duty of the commander of an aircraft to take all possible measures to ensure that his aircraft does not collide with any other aircraft or with any vehicle.

- (a) (3) (a) Flying machines and vehicles shall give way to aircraft which are taking off or landing.
- (b) Vehicles, and flying machines which are not taking off or landing, shall give way to vehicles towing aircraft.
- (c) Vehicles which are not towing aircraft shall give way to aircraft.

(4) Subject to the provisions of paragraph (3) of this Rule and of Rule 17(7)(c) of these Rules, in case of danger of collision between two flying machines:—

- (a) when the two flying machines are approaching head-on or approximately so, each shall alter its course to the right;
- (b) when the two flying machines are on converging courses, the one which has the other on its right shall give way to the other and shall avoid crossing ahead of the other unless passing well clear of it;
- (c) a flying machine which is being overtaken shall have the right-of-way, and the overtaking flying machine shall keep out of the way of the other flying machine by altering its course to the left until that other machine has been passed and is clear, notwithstanding any change in the relative positions of the two flying machines.

(5) Subject to the provisions of paragraph (3)(b) of this Rule a vehicle shall—

- (a) overtake another vehicle so that the other vehicle is on the left of the overtaking vehicle;
- (b) keep to the left when passing another vehicle which is approaching head-on or approximately so.

Launching, picking up and dropping of tow ropes etc.

34.—(1) Tow ropes, banners or similar articles towed by aircraft shall not be launched at an aerodrome except in accordance with arrangements made with an air traffic control unit at the aerodrome or, if there is no such unit, with the person in charge of the aerodrome.

(2) Tow ropes, banners or similar articles towed by aircraft shall not be picked up by or dropped from aircraft at an aerodrome except:—

Status: This is the original version (as it was originally made). This item of legislation is currently only available in its original format.

- (a) in accordance with arrangements with an air traffic control unit at the aerodrome or, if there is no such unit, with the person in charge of the aerodrome; or
- (b) in the area designated by the marking described in Rule 40(7) of these Rules, and the ropes, banners or similar articles shall be picked up and dropped when the aircraft is flying in the direction appropriate for landing.

Flight within aerodrome traffic zones

35.—(1) Paragraphs (2) and (3) of this Rule shall apply only in relation to such of the aerodromes described in Column 1 of the following Table as are notified for the purposes of this Rule and at such times as are specified in Column 2 thereof.

TABLE

<i>Column 1</i>	<i>Column 2</i>
(a) (a) A Government aerodrome	at such times as are notified
(b) (b) An aerodrome having an air traffic control unit or an aerodrome flight information unit	during the notified hours of watch of the air traffic control unit or the aerodrome flight information unit
(c) (c) A licensed aerodrome having a means of two-way radio communication with aircraft	during the notified hours of watch of the air/ground radio

(2) An aircraft shall not fly, take off or land, within the aerodrome traffic zone of an aerodrome to which this paragraph applies unless the commander of the aircraft has obtained the permission of the air traffic control unit at the aerodrome or, where there is no air traffic control unit, has obtained from the aerodrome flight information unit at that aerodrome information to enable the flight within the zone to be conducted with safety or, where there is no air traffic control unit nor aerodrome flight information unit, has obtained information from the air/ground radio station at that aerodrome to enable the flight to be conducted with safety.

(3) The commander of an aircraft flying within the aerodrome traffic zone of an aerodrome to which this paragraph applies shall:

- (a) cause a continuous watch to be maintained on the appropriate radio frequency notified for communications at the aerodrome or, if this is not possible, cause a watch to be kept for such instructions as may be issued by visual means;
- (b) where the aircraft is fitted with means of communication by radio with the ground, communicate his position and height to the air traffic control unit, the aerodrome flight information unit or the air/ground radio station at the aerodrome (as the case may be), on entering the zone and immediately prior to leaving it.

Use of radio navigation aid

36. The commander of an aircraft shall not make use of any radio navigation aid without complying with such restrictions and appropriate procedures as may be notified in relation to that aid unless authorised by the appropriate air traffic control unit:

Provided that he shall not be required to comply with this Rule if he is required to comply with Rule 27 of these Rules.

Status: This is the original version (as it was originally made). This item of legislation is currently only available in its original format.

SECTION VIII

AERODROME SIGNALS AND MARKINGS: VISUAL AND AURAL SIGNALS

General

37.—(1) Whenever any signal specified in this Section of these Rules is given or displayed, or whenever any marking so specified is displayed, by any person in an aircraft, or at an aerodrome, or any other place which is being used by aircraft for landing or take-off, it shall, when given or displayed in Hong Kong, have the meaning assigned to it in this Section.

(2) All dimensions specified in this Section of these Rules shall be subject to a tolerance of 10 per cent, plus or minus.

Signals in the signals area

38.—(1) When any signal specified in the following paragraphs of this Rule is displayed it shall be placed in a signals area, which shall be a square visible in all directions bordered by a white stripe 30 centimetres wide the internal sides measuring 12 metres.

(2) A white landing T, as illustrated in this paragraph,

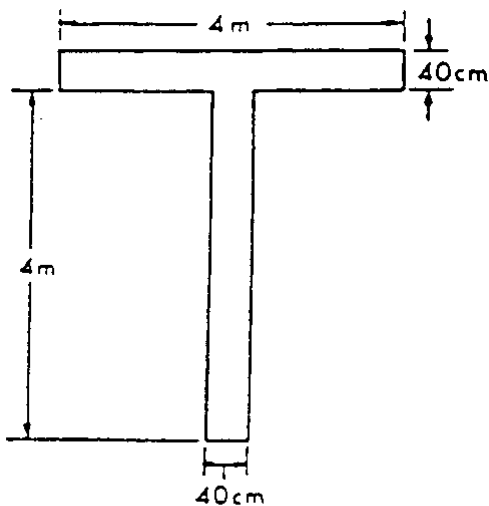

Fig. 1

signifies that aeroplanes and gliders taking off or landing shall do so in a direction parallel with the shaft of the T and towards the cross arm, unless otherwise authorised by the appropriate air traffic control unit.

(3) A white disc 60 centimetres in diameter displayed alongside the cross arm of the T and in line with the shaft of the T, as illustrated in this paragraph,

Status: This is the original version (as it was originally made). This item of legislation is currently only available in its original format.

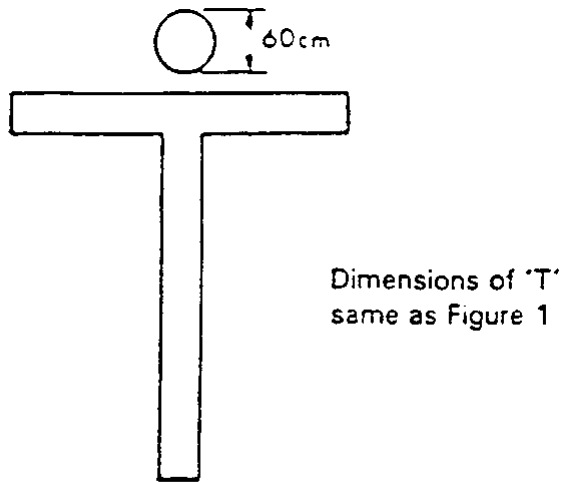

Fig. 2

signifies that the direction of landing and take-off do not necessarily coincide.

(4) A white dumb-bell, as illustrated in this paragraph,

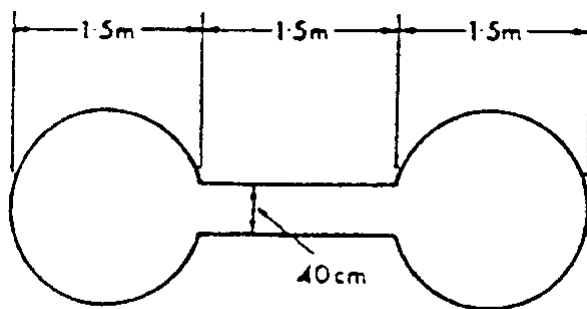

Fig. 3

signifies that movements of aeroplanes and gliders on the ground shall be confined to paved, metallated or similar hard surfaces.

(5) A white dumb-bell as described in (4) above but with a black stripe 60 centimetres wide across each disc at right angles to the shaft of the dumb-bell, as illustrated in this paragraph,

Status: This is the original version (as it was originally made). This item of legislation is currently only available in its original format.

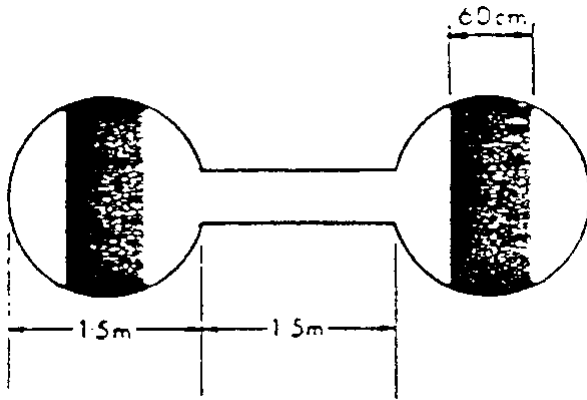

Fig. 4

signifies that aeroplanes and gliders taking off or landing shall do so on a runway but that movement on the ground is not confined to paved, metalled or similar hard surfaces.

(6) A red and yellow striped arrow, as illustrated in this paragraph,

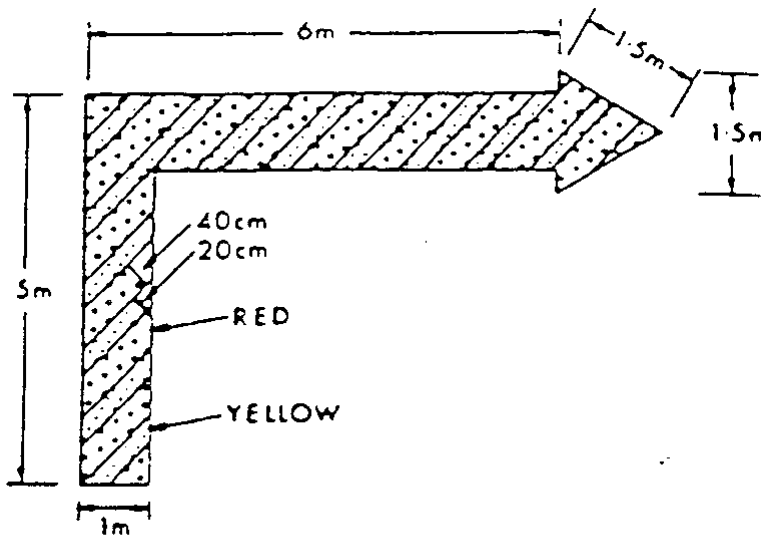

Fig. 5

the shaft of which is at least one metre wide placed along the whole or not less than a total of 11 metres of two adjacent sides of the signals area and pointing in a clockwise direction signifies that a right-hand circuit is in force.

(7) A red panel 3 metres square with a yellow stripe along one diagonal at least 50 centimetres wide, as illustrated in this paragraph,

Status: This is the original version (as it was originally made). This item of legislation is currently only available in its original format.

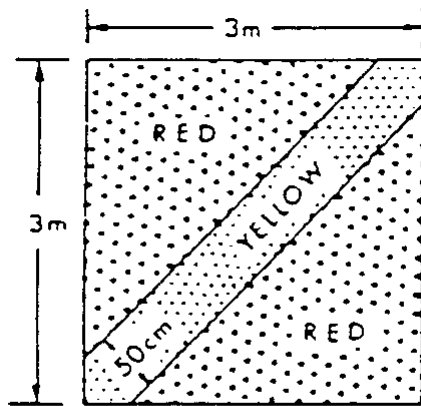
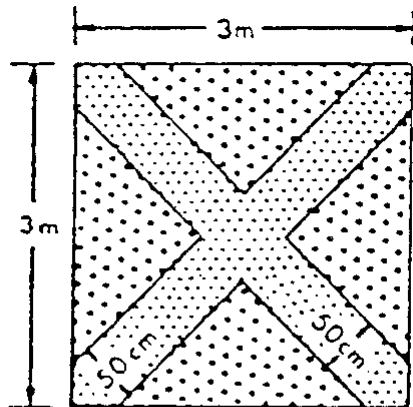

Fig. 6

signifies that the state of the manoeuvring area is poor and pilots must exercise special care when landing.

(8) A red panel 3 metres square with a yellow stripe, at least 50 centimetres wide, along each diagonal, as illustrated in this paragraph,



YELLOW STRIPES ON
RED BACKGROUND

Fig. 7

signifies that the aerodrome is unsafe for the movement of aircraft and that landing on the aerodrome is prohibited.

(9) A white letter H, as illustrated in this paragraph,

Status: This is the original version (as it was originally made). This item of legislation is currently only available in its original format.

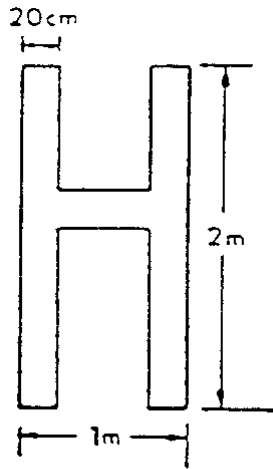

Fig. 8

signifies that helicopters shall take off and land only within the area designated by the marking specified in Rule 40(5) of these Rules.

(10) A red letter L displayed on the dumb-bell specified in paragraphs (4) and (5) of this Rule, as illustrated in this paragraph,

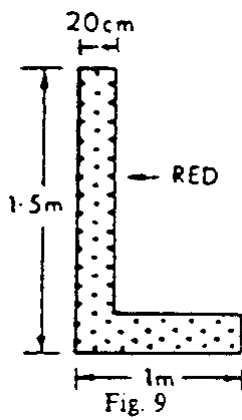

Fig. 9

signifies that light aircraft are permitted to take off and land either on a runway or on the area designated by the marking specified in Rule 40(6) of these Rules.

(11) A white double cross, as illustrated in this paragraph,

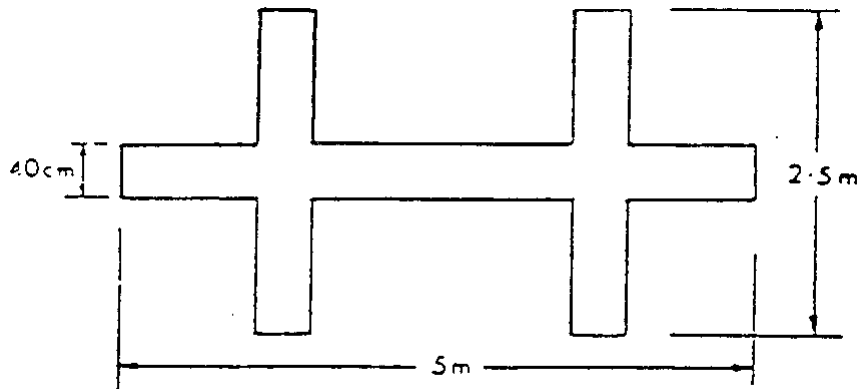

Fig. 10

signifies that glider flying is in progress.

Markings for Paved Runways and Taxiways

39.—(1) Two or more white crosses, as illustrated in this paragraph,

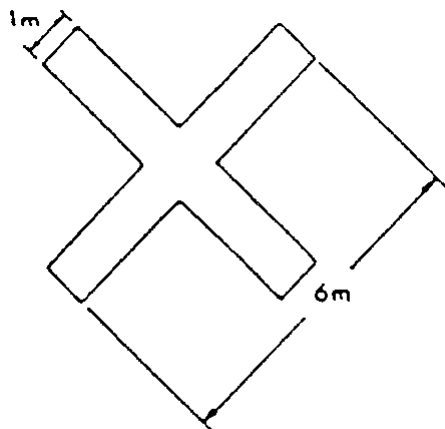

Fig. 11

displayed on a runway or taxiway, with the arms of the crosses at an angle of 45° to the centre line of the runway, at intervals of not more than 300 metres signify that the section of the runway or taxiway marked by them is unfit for the movement of aircraft.

(2) Two white continuous lines or two white broken lines and two continuous lines, as illustrated in this paragraph,

Status: This is the original version (as it was originally made). This item of legislation is currently only available in its original format.

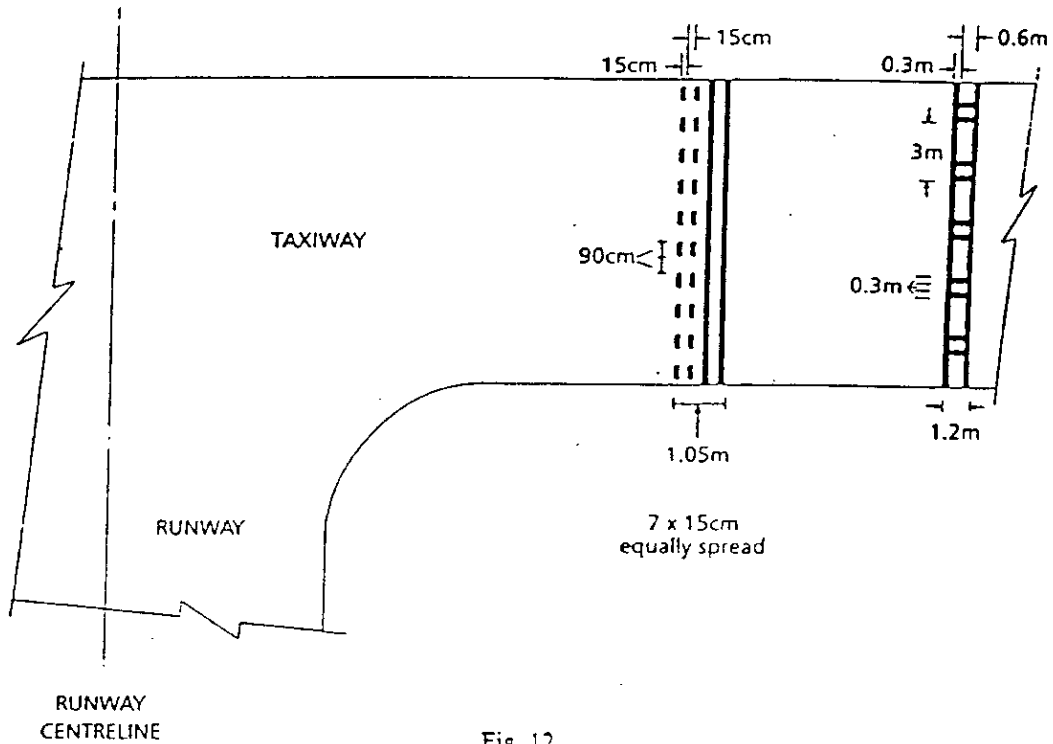

Fig. 12

signify a holding position beyond which no part of an aircraft or vehicle shall project in the direction of the runway without permission from an air traffic control unit.

(3) Orange and white markers, as illustrated in this paragraph,

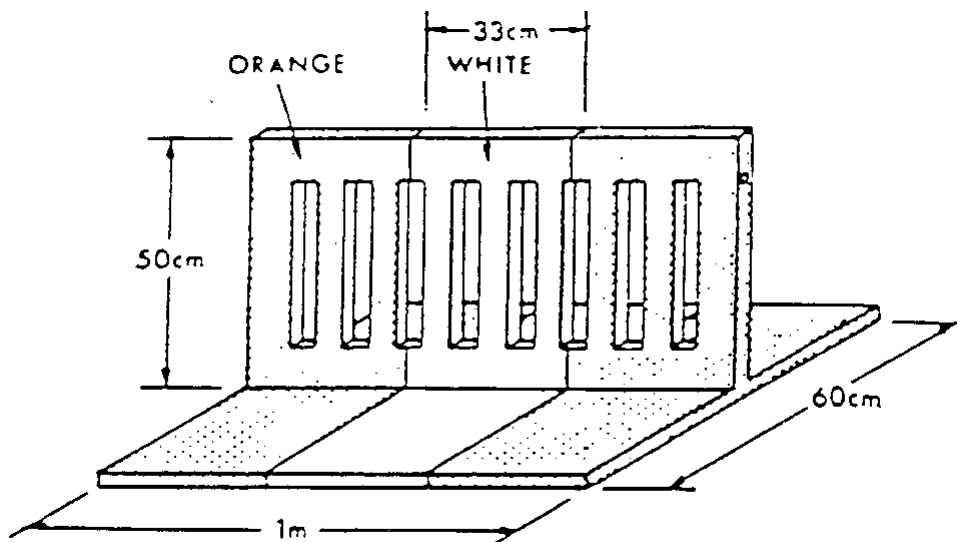

Fig. 13

spaced not more than 15 metres apart, signify the boundary of that part of a paved runway, taxiway or apron which is unfit for the movement of aircraft.

Status: This is the original version (as it was originally made). This item of legislation is currently only available in its original format.

Markings on unpaved manoeuvring areas

40.—(1) Markers with orange and white stripes of an equal width of not less than 50 centimetres, with an orange stripe at each end, as illustrated in this paragraph,

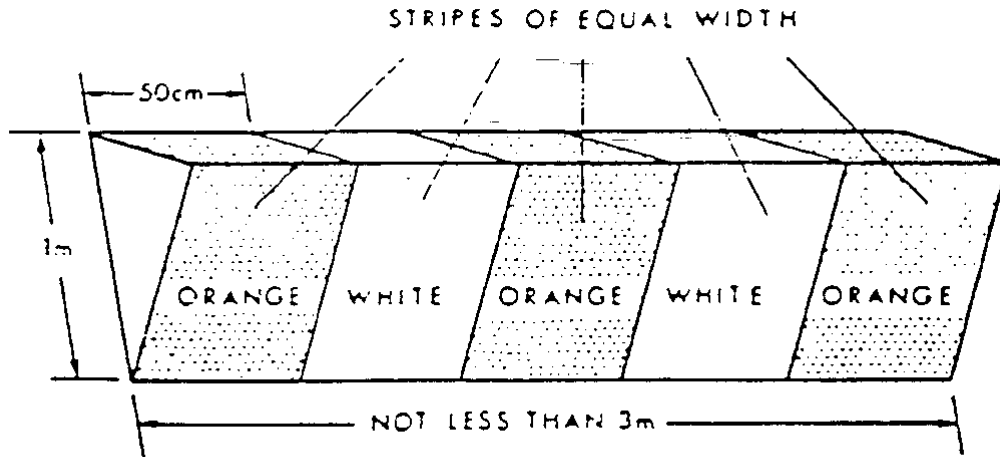

Fig. 14

alternating with flags not less than 60 centimetres square showing equal orange and white triangular areas, indicate the boundary of an area unfit for the movement of aircraft and one or more white crosses as specified in Rule 39(1) of these Rules indicate the said area. The distance between any two successive orange and white flags shall not exceed 90 metres.

(2) Striped markers, as specified in paragraph (1) of this Rule, spaced not more than 45 metres apart, indicate the boundary of an aerodrome.

(3) On structures, markers with orange and white vertical stripes, of an equal width of not less than 50 centimetres, with an orange stripe at each end, as illustrated in this paragraph,

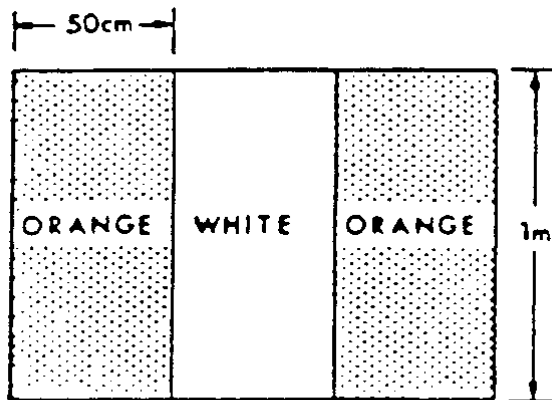

Fig. 15

spaced not more than 45 metres apart, indicate the boundary of an aerodrome. The pattern of the marker shall be visible from inside and outside the aerodrome and the marker shall be affixed not more than 15 centimetres from the top of the structure.

Status: This is the original version (as it was originally made). This item of legislation is currently only available in its original format.

(4) White flat rectangular markers 3 metres long and 1 metre wide at intervals not exceeding 90 metres, flush with the surface of the unpaved runway or stopway, as the case may be, indicate the boundary on an unpaved runway or of a stopway.

(5) A white letter H, as illustrated in this paragraph,

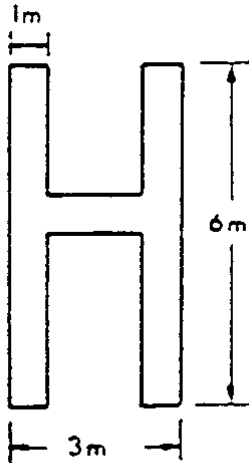

Fig. 16

indicates an area which shall be used only for the taking off and landing of helicopters.

(6) A white letter L, as illustrated in this paragraph,

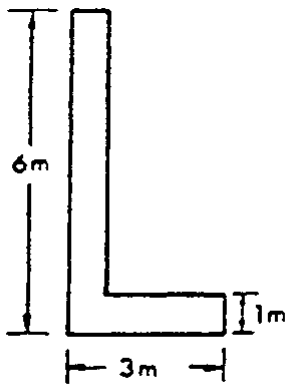

Fig. 17

indicates a part of the manoeuvring area which shall be used only for the taking off and landing of light aircraft.

(7) A yellow cross with two arms 6 metres long by 1 metre wide at right angles, indicates that tow ropes and similar articles towed by aircraft shall only be picked up and dropped in the area in which the cross is placed.

(8) A white double cross, as illustrated in this paragraph,

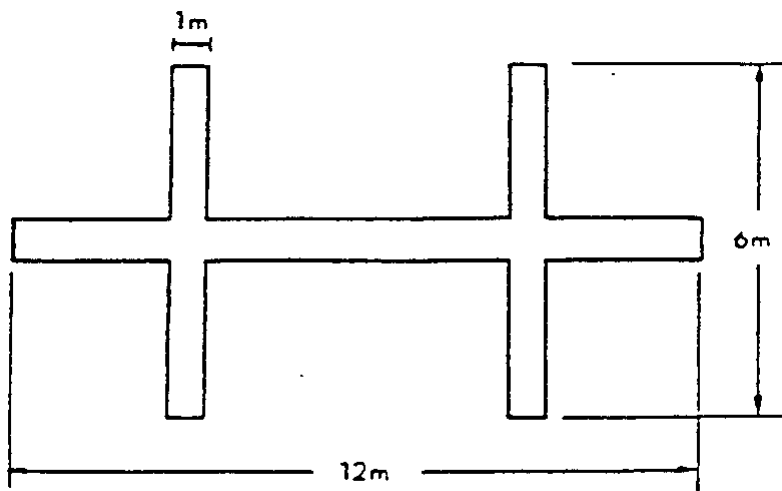

Fig. 18

indicates an area which shall be used only for the taking off and landing of gliders.

(9) A white landing T as specified in Rule 38(2) of these Rules placed at the left hand side of the runway when viewed from the direction of landing indicates the runway to be used, and at an aerodrome with no runway it indicates the direction for take-off and landing.

Signals visible from the ground

41.—(1) A black ball 60 centimetres in diameter suspended from a mast signifies that the directions of take-off and landing are not necessarily the same.

(2) A checkered flag or board, 1.2 metres by 90 centimetres containing twelve equal squares, 4 horizontally and 3 vertically, coloured red and yellow alternately, signifies that aircraft may move on the manoeuvring area and apron only in accordance with the permission of the air traffic control unit at the aerodrome.

(3) Two red balls 60 centimetres in diameter, disposed vertically one above the other, 60 centimetres apart and suspended from a mast, signify that glider flying is in progress at the aerodrome.

(4) Black arabic numerals in two-figure groups and, where parallel runways are provided the letter or letters L (left), LC (left centre), C (centre), RC (right centre) and R (right), placed against a yellow background, indicate the direction for take-off for the runway in use.

(5) A black letter C against a yellow background, as illustrated in this paragraph,

Status: This is the original version (as it was originally made). This item of legislation is currently only available in its original format.

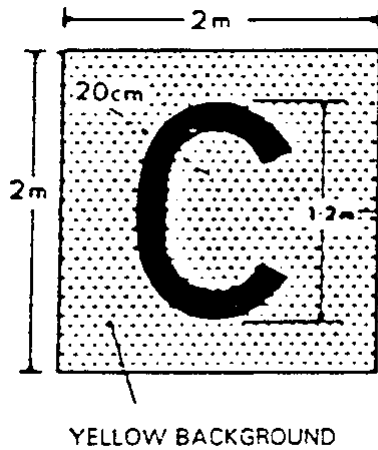

Fig. 19

indicates the position at which a pilot can report to the air traffic control unit or to the person in charge of the aerodrome.

(6) A rectangular green flag of not less than 60 centimetres square flown from a mast indicates that a right hand circuit is in force.

Lights and pyrotechnic signals for control of aerodrome traffic

42. Each signal described in the first column of Table A, when directed from an aerodrome to an aircraft or to a vehicle, or from an aircraft, shall have the meanings respectively appearing in the second, third and fourth columns of that Table opposite the description of the signal.

Table A

Meaning of Lights and Pyrotechnic Signals

Characteristic and colour of light or pyrotechnic	From an aerodrome		
	to an aircraft in flight	to an aircraft or vehicle on the aerodrome	From an aircraft in flight to an aerodrome
(a) Continuous red light	Give way to other aircraft and continue circling.	Stop	—
(b) Red pyrotechnic light, or red flare	Do not land; wait for permission.	—	Immediate assistance is requested.
(c) Red flashes	Do not land; aerodrome not available for landing.	Move clear of landing area.	—
(d) Green flashes	Return to aerodrome; wait for permission to land.	To an aircraft: You may move on the manoeuvring area and apron;	—

Status: This is the original version (as it was originally made). This item of legislation is currently only available in its original format.

Characteristic and colour of light or pyrotechnic	From an aerodrome to an aircraft in flight	to an aircraft or vehicle on the aerodrome	From an aircraft in flight to an aerodrome
(e) Continuous green light	You may land.	To a vehicle: You may move on the manoeuvring area. You may take off (not applicable to a vehicle).	—
(f) Continuous green light, or green flashes, or green pyrotechnic light	—	—	By night: May I land? By day: May I land in direction different from that indicated by landing T?
(g) White flashes	Land at this aerodrome after receiving continuous green light, and then, after receiving green flashes, proceed to the apron.	Return to starting point on the aerodrome.	I am compelled to land.
(h) White pyrotechnic lights	—	—	I am compelled to land.
Switching on and off the navigation lights			
Switching on and off the landing lights			

Marshalling signals (from a marshaller to an aircraft)

43. Each of the signals for the guidance of aircraft manoeuvring on or off the ground, described in the first column of Table B, paragraphs (a) to (x) shall, in Hong Kong have the meanings set forth in the second column of that Table opposite the description of the signal. By day any such signals shall be given by hand or by circular bats and by night by torches or illuminated wands.

Status: This is the original version (as it was originally made). This item of legislation is currently only available in its original format.

Table B—Meaning of marshalling signals (Rule 43)

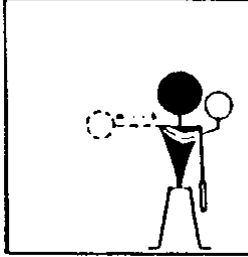
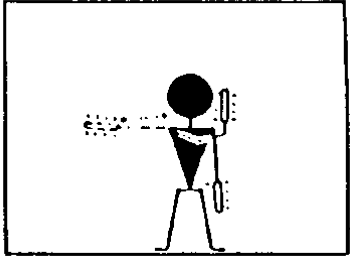
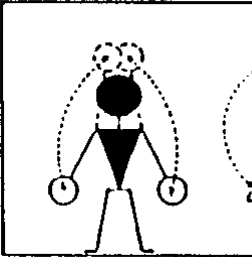
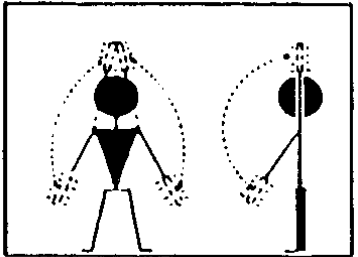
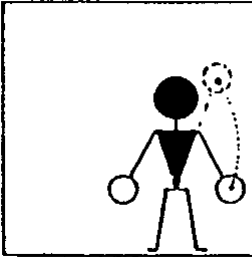
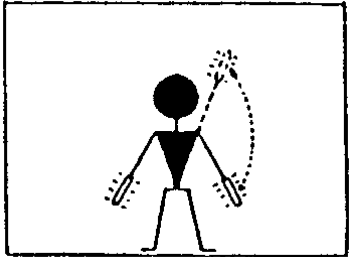
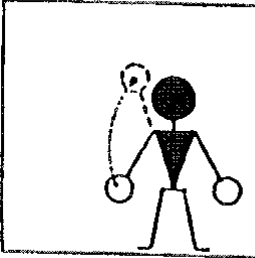
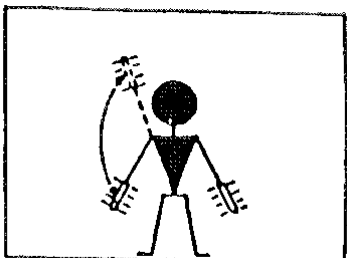
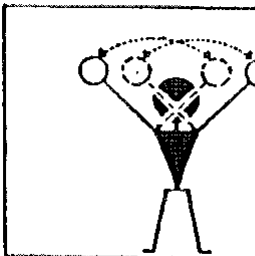
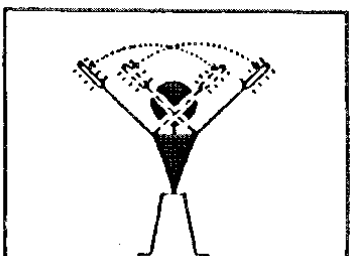
<i>Description of signal</i>	<i>Meaning of signal</i>	<i>In daylight</i>	<i>By night</i>
(a) Right or left arm down, the other arm moved across body and extended to indicate position of the other marshaller.	Proceed under guidance of another marshaller.		
(b) Arms repeatedly moved upward and backward, beckoning onward.	Move ahead.		
(c) Right arm down, left arm repeatedly moved upward and backward. The speed of arm movement indicates the rate of turn.	Open up starboard engine or turn to port.		
(d) Left arm down, the right arm repeatedly moved upward and backward. The speed of arm movement indicates the rate of turn.	Open up port engine or turn to starboard.		
(e) Arms repeatedly crossed above the head. The speed of arm movement indicates the urgency of the stop.	Stop.		

Status: This is the original version (as it was originally made). This item of legislation is currently only available in its original format.

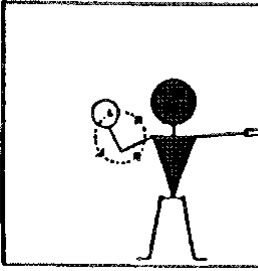
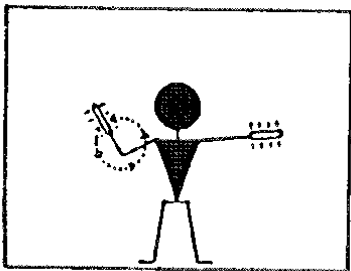
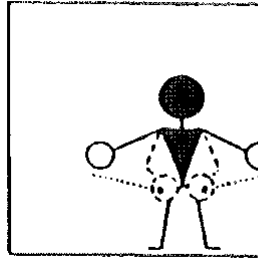
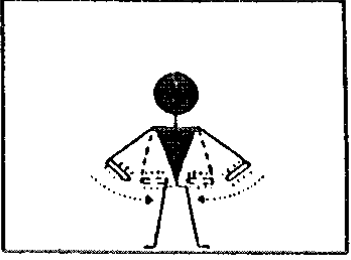
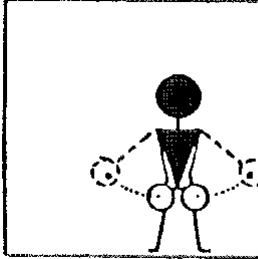
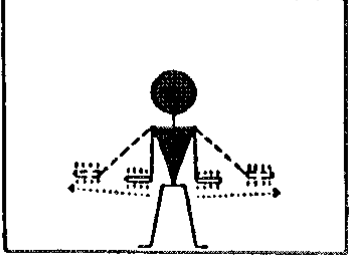
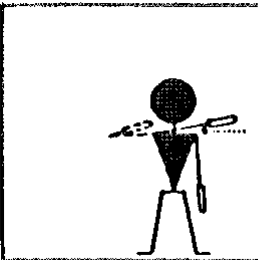
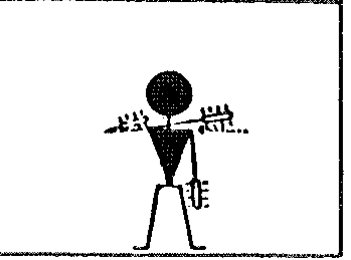
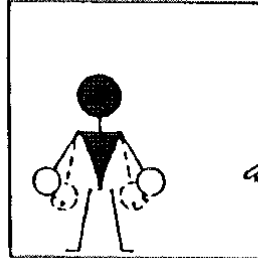
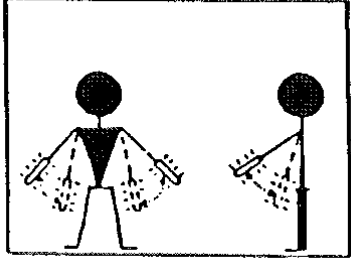
Description of signal	Meaning of signal	In daylight	By night
(f) A circular motion of the right hand at head level, with the left arm pointing to the appropriate engine.	Start engines.		
(g) Arms extended, the palms facing inwards, then swung from the extended position inwards.	Chocks inserted.		
(h) Arms down, the palms facing outwards, then swung outwards.	Chocks away.		
(j) Either arm and hand placed level with the chest, then moved laterally with the palm downwards.	Cut engines.		
(k) Arms placed down, with the palms towards the ground, then moved up and down several times.	Slow down.		

Status: This is the original version (as it was originally made). This item of legislation is currently only available in its original format.

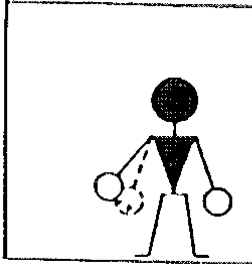
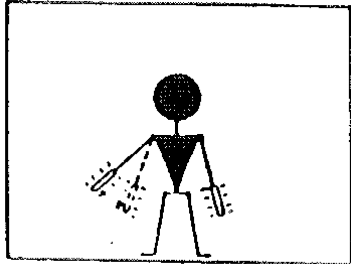
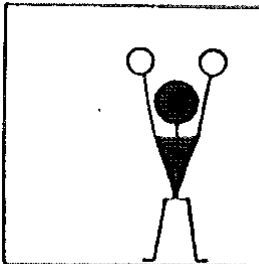
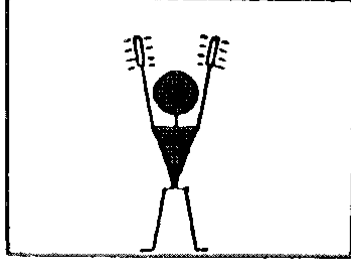
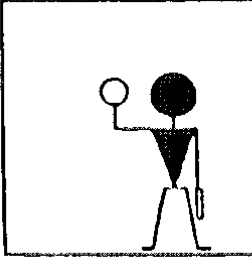
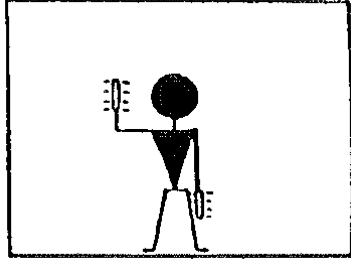
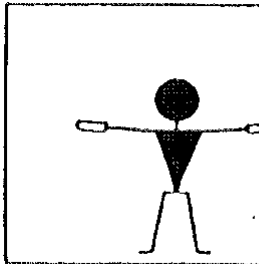
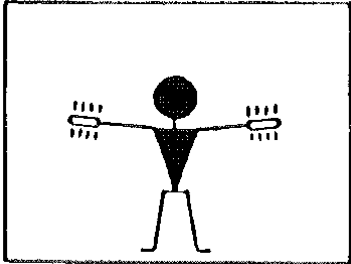
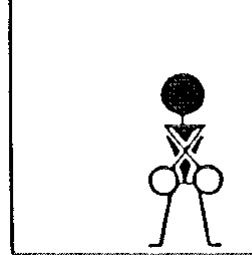
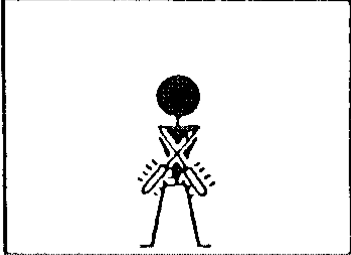
<i>Description of signal</i>	<i>Meaning of signal</i>	<i>In daylight</i>	<i>By night</i>
(l) Arms placed down, with the palms towards the ground, then either the right or left arm moved, up and down indicating that the motors on the left or right side, as the case may be, should be slowed down.	Slow down engines on indicated side.		
(m) Arms placed above the head in a vertical position.	This bay.		
(n) The right arm raised at the elbow, with the arm facing forward.	All clear: marshalling finished.		
(o) Arms placed horizontally sideways.	Hover.		
(p) Arms placed down and crossed in front of the body.	Land.		

Status: This is the original version (as it was originally made). This item of legislation is currently only available in its original format.

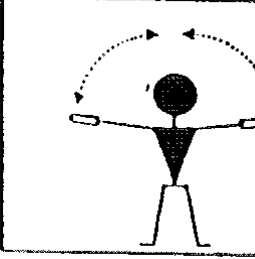
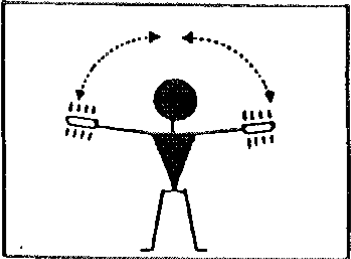
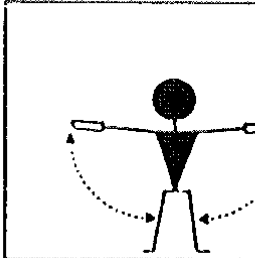
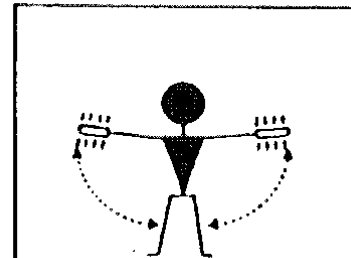
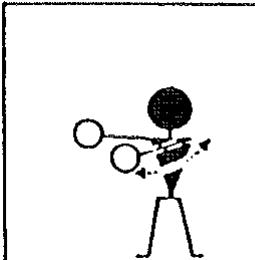
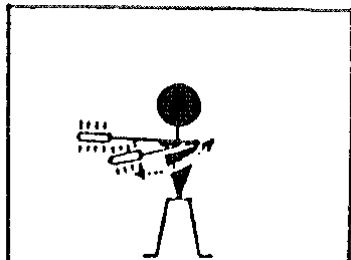
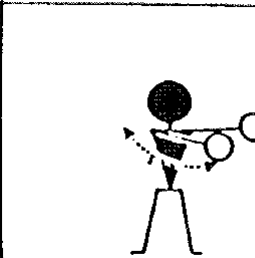
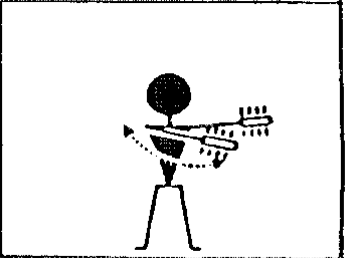
<i>Description of signal</i>	<i>Meaning of signal</i>	<i>In daylight</i>	<i>By night</i>
(q) Arms placed horizontally sideways with the palms up beckoning upwards. The speed of arm movement indicates the rate of ascent.	Move upwards.		
(r) Arms placed horizontally sideways with the palms towards the ground beckoning downwards. The speed of arm movement indicates the rate of descent.	Move downwards.		
(s) Either arm placed horizontally sideways, then the other arm moved in front of the body to that side, in the direction of the movement, indicating that the helicopter should move horizontally to the left or right side, as the case may be; repeated several times.	Move horizontally.		
			

Status: This is the original version (as it was originally made). This item of legislation is currently only available in its original format.

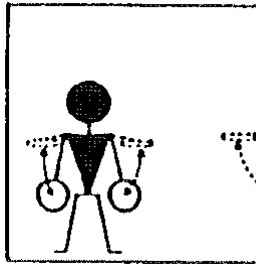
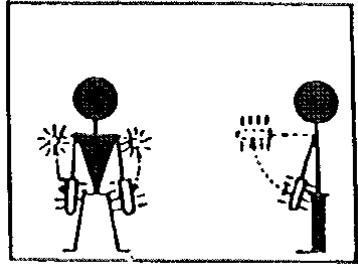
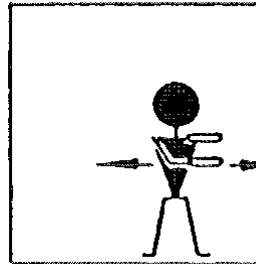
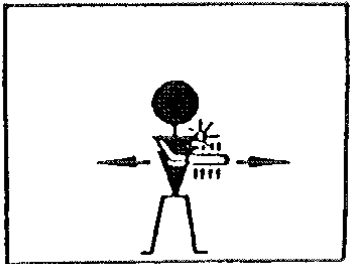
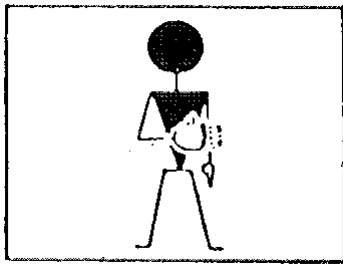
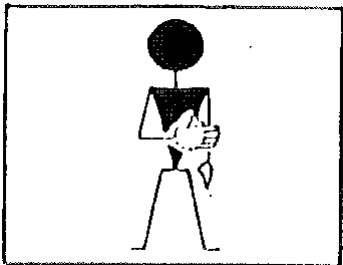
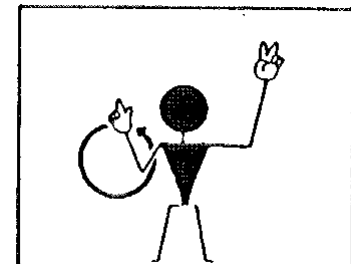
Description of signal	Meaning of signal	In daylight	By night
(t) Arms placed down, the palms facing forward, then repeatedly swept up and down to shoulder level.	Move back.		
(u) Left arm extended horizontally forward, then right arm making a horizontal slicing movement below left arm.	Release load.		
(v) Raise arm, with fist clenched, horizontally in front of body, then extend fingers.	Release brakes.		
Raise arm and hand, with fingers extended, horizontally in front of body, then clench fist.	Engage brakes.		
(w) Left hand overhead with the number of fingers extended, to indicate the number of the engine to be started, and circular motion of right hand at head level.	Start engine(s).		

Status: This is the original version (as it was originally made). This item of legislation is currently only available in its original format.

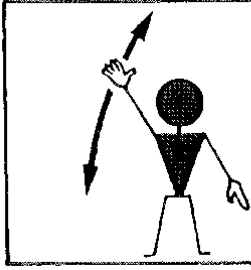
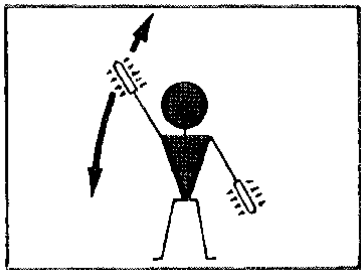
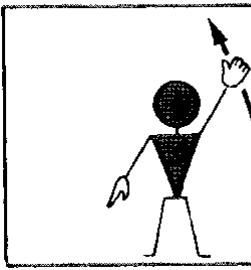
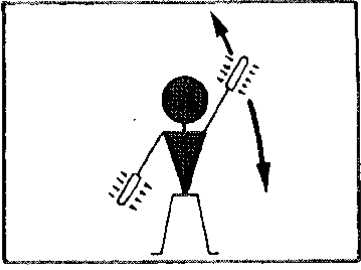
<i>Description of signal</i>	<i>Meaning of signal</i>	<i>In daylight</i>	<i>By night</i>
(x) Point left arm down, move right arm down from overhead, vertical position to horizontal forward position, repeating right arm movement.	Back aircraft's tail to starboard.		
Point right arm down, move left arm down from overhead, vertical position to horizontal forward position, repeating left arm movement.	Back aircraft's tail to port.		

Marshalling signals (from a pilot of an aircraft to a marshaller)

44. The following signals made by a pilot in an aircraft to a marshaller on the ground shall respectively have the following meanings:

<i>Description of Signal</i>	<i>Meaning of Signal</i>
(a) Raise arm and hand with fingers extended horizontally in front of face, then clench fist.	Brakes engaged
(b) Raise arm with fist clenched horizontally in front of face, then extend fingers.	Brakes released
(c) Arms extended palms facing outwards, move hands inwards to cross in front of face.	Insert chocks
(d) Hands crossed in front of face, palms facing outwards, move arms outwards.	Remove chocks
(e) Raise the number of fingers on one hand indicating the number of the engine to be started. For this purpose the aircraft engines shall be numbered in relation to the marshaller facing the aircraft, from his right to his left for example, No. 1 engine shall be the port outer engine, No. 2 engine shall be the port inner engine, No. 3 engine shall be the starboard inner engine, and No. 4 engine shall be the starboard outer engine.	Ready to start engines

Status: This is the original version (as it was originally made). This item of legislation is currently only available in its original format.

Distress, urgency and safety signals

45.—(1) The following signals, given either together or separately before the sending of a message, signify that an aircraft is threatened by grave and imminent danger and requests immediate assistance—

- (a) by radiotelephony—
 - the spoken word “MAYDAY”;
- (b) visual signalling—
 - (i) the signal SOS (. . . --- . . .);
 - (ii) a succession of pyrotechnic lights fired at short intervals each showing a single red light;
 - (iii) a parachute flare showing a red light;
- (c) by sound signalling other than radiotelephony—
 - (i) the signal SOS (. . . --- . . .);
 - (ii) a continuous sounding with any sound apparatus.

(2) The following signals, given either together or separately, before the sending of a message signify that the commander of the aircraft wishes to give notice of difficulties which compel it to land but that he does not require immediate assistance—

- (a) a succession of white pyrotechnic lights;
- (b) the repeated switching on and off of the aircraft landing lights;
- (c) the repeated switching on and off of its navigation lights, in such a manner as to be clearly distinguishable from the flashing navigation lights described in Rule 11 of these Rules.

(3) The following signals, given either together or separately, indicate that the commander of the aircraft has an urgent message to transmit concerning the safety of a ship, aircraft, vehicle or other property or of a person on board or within sight of the aircraft from which the signal is given—

- (a) by radiotelephony—the spoken words “PAN PAN”;
- (b) by visual signalling—the signal XXX (- . . - - . . - - . . -);
- (c) the sound signalling other than radiotelephony—the signal XXX (- . . - - . . - - . . -).

Warning signals to aircraft in flight

In Hong Kong by day or by night, a series of projectiles discharged from the ground at intervals of 10 seconds, each showing, on bursting, red and green lights or stars, shall indicate to the commander of an aircraft that his aircraft is flying in or about to enter an active danger area or an area to which regulations made pursuant to Article 69(1)(a)(iii) of this Order relate and that he is required to take such action as may be necessary to leave the area or change course to avoid the area.

SCHEDULE 15

Article 9(3)(a)(iii), 11(3) and(6)(a)(iii), 14, 27(1)(c), 28(4),29(1), 36, 78 and 86(1)

AIR NAVIGATION (GENERAL) REGULATIONS

Load Sheets

1.—(1) Every load sheet required by Article 28(4) of this Order shall contain the following particulars:

- (a) the nationality and registration mark of the aircraft to which the load sheet relates;
- (b) particulars of the flight to which the load sheet relates;
- (c) the total weight of the aircraft as loaded for that flight;
- (d) the weights of the several items from which the total weight of the aircraft, as so loaded, has been calculated including in particular the weight of the aircraft prepared for service and the respective total weights of the crew (unless included in the weight of the aircraft prepared for service), passengers, baggage and cargo intended to be carried on the flight;
- (e) the manner in which the load is distributed and the resulting position of the centre of gravity of the aircraft which may be given approximately if and to the extent that the relevant certificate of airworthiness so permits,

and shall include a certificate, signed by the person referred in Article 28(1) of this Order as responsible for the loading of the aircraft, that the aircraft has been loaded in accordance with the written instructions furnished to him by the operator of the aircraft pursuant to the said Article 28(1).

- (a) (2) (a) For the purpose of calculating the total weight of the aircraft the respective total weights of the passengers and crew entered in the load sheet shall be computed from the actual weight of each person and for that purpose each person shall be separately weighed; Provided that, in the case of an aircraft of which the maximum total weight authorised exceeds 5,700 kg or which has a total seating capacity authorised by the certificate of airworthiness in force in respect of that aircraft of 12 or more persons, the total weights of the passengers and crew may, subject to the provisions of sub-paragraph (b) of this paragraph and of paragraph (4) of this regulation, be calculated at not less than the appropriate weights shown in Table 1 and the load sheet shall bear a notation to that effect—

Table 1

Males over 12 years of age	75 kg.
Save that on journeys by helicopters in support of or in connection with the exploitation of or exploration for mineral resources (including gas) and—	
(i) between Hong Kong and any vessel or structure located at sea, or	
(ii) between any two such vessels or structures where the last preceding journey from land or the next subsequent journey to land was from or is intended to be, as the case may be, Hong Kong:	
the appropriate weight for male passengers over 12 years shall be	83 kg.
Females over 12 years of age	65 kg.
Children aged 2 years or more, but not over 12 years of age	39 kg.

Status: This is the original version (as it was originally made). This item of legislation is currently only available in its original format.

Infants under 2 years of age 8 kg.

- (b) The actual weight of any immersion suit worn or carried by a passenger or crew member shall be added to the appropriate weight shown in Table 1 in each case.
- (c) For the purposes of this regulation, “sea” includes any estuary or arm of the sea.
- (a) (3) (a) For the purpose of calculating the total weight of the aircraft the respective total weights of the baggage and cargo entered in the load sheet shall be computed from the actual weight of each piece of baggage, cargo or cargo container and for that purpose each piece or container shall be separately weighed;

Provided that, in the case of an aeroplane of which the maximum total weight authorised exceeds 5,700 kg, or which has a total seating capacity of 12 or more persons, the total weight of the baggage may, subject to the provisions of paragraph (4) of this Regulation, be calculated at not less than the weights shown in Table 2 and the load sheet shall bear a notation to that effect;

Table 2

1	2
Cabin baggage per passenger*	Hold baggage per piece
3 kg	16 kg

* Not infants under 2 years of age.

- (a) If Table 2 has been used, subject to the provision of paragraph (4) for determining the weight of hold baggage, it shall also be used, subject as aforesaid, for determining the weight of the cabin baggage.
- (a) (4) (a) If it appears to the person supervising the loading of the aircraft that any passenger or baggage to be carried exceeds the weights set out in Table 1 or Table 2 of this Regulation he shall, if he considers it necessary in the interests of the safety of the aircraft, or if the Governor has so directed in the particular case, require any such person or baggage to be weighed for the purpose of the entry to be made in the load sheet.
- (b) If any person or baggage has been weighed pursuant to sub-paragraph (a) of this paragraph, the weights entered in the load sheet shall take account of the actual weight of that person or baggage, or of the weight determined in accordance with the respective provisions to paragraph (2) or (3), whichever weight shall be the greater.

Weight and Performance: General provisions

2.—(1) The assessment of the ability of an aeroplane to comply with the requirement of Regulations 3 to 8 inclusive and of a helicopter to comply with the requirements of Regulations 9 to 11 inclusive (relating in either case to weight, performance and flights in specified meteorological conditions or at night) shall be based on the specified information as to its performance:

Provided that, in the case of an aeroplane in respect of which there is in force under this Order a certificate of airworthiness which does not include a performance group classification, the assessment may be based on the best information available to the commander of the aircraft, in so far as the relevant information is not specified.

(2) In assessing the ability of an aeroplane to comply with condition (7) in the Annex hereto, conditions (4) and (5) of Regulation 4, and conditions (2)(i)(b) and (2)(ii) of Regulation 8, account may be taken of any reduction of the weight of the aeroplane which may be achieved after the failure of a power unit by such jettisoning of fuel as is feasible and prudent in the circumstances of the

flight and in accordance with the flight manual included in the certificate of airworthiness relating to the aircraft.

(3) In Regulations 2 to 11 inclusive, and in the Annex hereto, unless the context otherwise requires:

“specified” in relation to an aircraft means specified in, or ascertainable by reference to—

- (a) the certificate of airworthiness in force under this Order in respect of that aircraft; or
- (b) the flight manual or performance schedule included in that certificate, or other document, whatever its title, incorporated by reference in that certificate;

“the emergency distance available” means the distance from the point on the surface of the aerodrome at which the aeroplane can commence its take-off run to the nearest point in the direction of take-off at which the aeroplane cannot roll over the surface of the aerodrome and be brought to rest in an emergency without risk of accident;

“the landing distance available” means the distance from the point on the surface of the aerodrome above which the aeroplane can commence its landing, having regard to the obstruction in its approach path, to the nearest point in the direction of landing at which the surface of the aerodrome is incapable of bearing the weight of the aeroplane under normal operating conditions or at which there is an obstacle capable of affecting the safety of the aeroplane;

“the take-off distance available” means either the distance from the point on the surface of the aerodrome at which the aeroplane can commence its take-off run to the nearest obstacle in the direction of take-off projecting above the surface of the aerodrome and capable of affecting the safety of the aeroplane or one and one half times the take-off run available whichever is the less;

“the take-off run available” means the distance from the point on the surface of the aerodrome at which the aeroplane can commence its take-off run to the nearest point in the direction of take-off at which the surface of the aerodrome is incapable of bearing the weight of the aeroplane under normal operating conditions.

(4) For the purposes of Regulations 2 to 8 inclusive, and of the Annex hereto:

- (a) the weight of the aeroplane at the commencement of the take-off run shall be taken to be its gross weight including everything and everyone carried in or on it at the commencement of the take-off run;
- (b) the landing weight of the aeroplane shall be taken to be the weight of the aeroplane at the estimated time of landing allowing for the weight of the fuel and oil expected to be used on the flight to the aerodrome at which it is intended to land or alternate aerodrome, as the case may be;
- (c) where any distance referred to in paragraph (3) of this Regulation has been declared in respect of any aerodrome by the authority responsible for regulating air navigation over the territory of the Contracting State in which the aerodrome is situated and in the case of an aerodrome in Hong Kong notified, that distance shall be deemed to be the relevant distance.

(5) Nothing in Regulations 2 to 11 inclusive shall apply to any aircraft flying solely for the purpose of training persons to perform duties in aircraft.

Weight and Performance of Public Transport Aeroplanes having no Performance Group Classification in their Certificates of Airworthiness

3. With reference to Article 29(1) of this Order an aeroplane registered in Hong Kong in respect of which there is in force under this Order a certificate of airworthiness which does not include a performance group classification shall not fly for the purpose of public transport unless the weight

Status: This is the original version (as it was originally made). This item of legislation is currently only available in its original format.

of the aeroplane at the commencement of the take-off run is such that such of the conditions in the Annex hereto as apply to that aircraft are satisfied.

Weight and Performance of Public Transport Aeroplanes classified as Aeroplanes of Performance Group A in their Certificates of Airworthiness.

4. With reference to Article 29(1) of this Order an aeroplane registered in Hong Kong in respect of which there is in force under this Order a certificate of airworthiness in which the aeroplane is designated as being of performance group A shall not fly for the purpose of public transport unless the weight of the aeroplane at the commencement of the take-off run is such that the following conditions are satisfied:

(1) That weight does not exceed the maximum take-off weight for altitude and temperature specified for the altitude and the air temperature at the aerodrome at which the take-off is to be made.

(2) The take-off run, take-off distance and the emergency distance respectively required for take-off, specified as being appropriate to—

- (a) the weight of the aeroplane at the commencement of the take-off run;
- (b) the altitude at the aerodrome;
- (c) the air temperature at the aerodrome;
- (d) the condition of the surface of the runway from which the take-off will be made;
- (e) the slope of the surface of the aerodrome in the direction of take-off over the take-off run available, the take-off distance available and the emergency distance available, respectively; and
- (f) not more than 50 per cent of the reported wind component opposite to the direction of take-off or not less than 150 per cent of the reported wind component in the direction of take-off,

do not exceed the take-off run, the take-off distance and the emergency distance available, respectively, at the aerodrome at which the take-off is to be made; in ascertaining the emergency distance required, the point at which the pilot is assumed to decide to discontinue the take-off shall not be nearer to the start of the take-off run than the point at which, in ascertaining the take-off run required and the take-off distance required, he is assumed to decide to continue the take-off, in the event of power unit failure.

- (a) (3) (a) The net take-off flight path with one power unit inoperative, specified as being appropriate to:—
 - (i) the weight of the aeroplane at the commencement of the take-off run;
 - (ii) the altitude at the aerodrome;
 - (iii) the air temperature at the aerodrome; and
 - (iv) not more than 50 per cent of the reported wind component opposite to the direction of take-off or not less than 150 per cent of the reported wind component in the direction of take-off,

and plotted from a point 35 feet or 50 feet, as appropriate, above the end of the take-off distance required at the aerodrome at which the take-off is to be made to a height of 1,500 feet above the aerodrome, shows that the aeroplane will clear any obstacle in its path by a vertical interval of at least 35 feet; and if it is intended that the aeroplane shall change its direction of flight by more than 15° the vertical interval shall not be less than 50 feet during the change of direction.

- (b) For the purpose of sub-paragraph (a) hereof an obstacle shall be deemed to be in the path of the aeroplane if the distance from the obstacle to the nearest point on the ground below the intended line of flight of the aeroplane does not exceed—

Status: This is the original version (as it was originally made). This item of legislation is currently only available in its original format.

- (i) a distance of 60 metres plus half the wing span of the aeroplane plus one eighth of the distance from such point to the end of the take-off distance available measured along the intended line of flight of the aeroplane; or
- (ii) 900 metres,

whichever is the less.

- (c) In assessing the ability of the aeroplane to satisfy this condition, it shall not be assumed to make a change of direction of a radius less than the specified radius of steady turn.

(4) The aeroplane will, in the meteorological conditions expected for the flight, in the event of any one power unit becoming inoperative at any point on its route or on any planned diversion therefrom and with the other power unit or units operating within the maximum continuous power conditions specified be capable of continuing the flight, clearing by a vertical interval of at least 2,000 feet obstacles within 10 nautical miles either side of the intended track to an aerodrome at which it can comply with condition (7) in this Regulation relating to an alternate aerodrome and on arrival over such aerodrome the gradient of the specified net flight path with one power unit inoperative shall not be less than zero at 1,500 feet above the aerodrome, and in assessing the ability of the aeroplane to satisfy this condition it shall not be assumed to be capable of flying at an altitude exceeding the specified maximum permissible altitude for power unit restarting:

Provided that where the operator of the aeroplane is satisfied, taking into account the navigation aids which can be made use of by the aeroplane on the route, that the commander of the aeroplane will be able to maintain his intended track on that route within a margin of 5 nautical miles, the foregoing provisions of this paragraph shall have effect as if 5 nautical miles were substituted for 10 nautical miles.

(5) In the case of an aeroplane having three or more power units, it will, in the meteorological conditions expected for the flight, in the event of any two power units becoming inoperative at any point along the route or on any planned diversion therefrom more than 90 minutes flying time in still air at the all power units operating economical cruising speed from the nearest aerodrome at which it can comply with condition (7) in this Regulation, relating to an alternate aerodrome, be capable of continuing the flight with all other power units operating within the specified maximum continuous power conditions, clearing by a vertical interval of at least 2,000 feet obstacles within 10 nautical miles either side of the intended track to such an aerodrome, and on arrival over such an aerodrome the gradient of the specified net flight path with two power units inoperative shall not be less than zero at 1,500 feet above the aerodrome; and in assessing the ability of the aeroplane to satisfy this condition it shall not be assumed to be capable of flying at an altitude exceeding the specified maximum permissible altitude for power unit restarting:

Provided that where the operator of the aeroplane is satisfied taking into account the navigation aids which can be made use of by the aeroplane on the route, that the commander of the aeroplane will be able to maintain his intended track on the route within a margin of five nautical miles, the foregoing provisions of this paragraph shall have effect as if five nautical miles were substituted for 10 nautical miles; or

In the case of an aeroplane having two power units and a maximum total weight authorised which exceeds 5,700 kg, and which is not limited by its certificate of airworthiness to the carriage of less than 20 passengers, it will, in the meteorological conditions expected for the flight, at any point along the route or on any planned diversion therefrom, not be more than 60 minutes flying time at the normal one engine inoperative cruise speed in still air from the nearest aerodrome at which it can comply with condition (7) in this Regulation, relating to an alternate aerodrome, unless it is flying under and in accordance with the terms of any written permission granted by the Governor to the operator under this Regulation; or

In the case of an aeroplane having two power units and a maximum total weight authorised of 5,700 kg or less or in the case of an aeroplane having two power units and a maximum total

Status: This is the original version (as it was originally made). This item of legislation is currently only available in its original format.

weight authorised of more than 5,700 kg, but which is limited by its certificate of airworthiness to the carriage of less than 20 passengers the aeroplane will, in the meteorological conditions expected for the flight, not be more than 90 minutes flying time in still air at the all power units operating economical cruising speed from the nearest aerodrome at which it can comply with condition (7) in this regulation, relating to an alternate aerodrome.

(6) The landing weight of the aeroplane will not exceed the maximum landing weight specified for the altitude and the expected air temperature for the estimated time of landing at the aerodrome at which it is intended to land and at any alternate aerodrome.

(a) (i) In the case of a turbine-jet powered aeroplane, the landing distance required does not exceed at the aerodrome at which it is intended to land or at any alternate aerodrome, as the case may be, the landing distance available on—

(aa) the most suitable runway for a landing in still air conditions; and

(bb) the runway that may be required for landing because of the forecast wind conditions.

(ii) In the case of an aeroplane powered by turbine propeller or piston engines, the landing distances required, respectively specified as being appropriate to aerodromes of destination and alternate aerodromes, do not exceed at the aerodrome at which it is intended to land or at any alternate aerodrome, as the case may be, the landing distance available on—

(aa) the most suitable runway for a landing in still air conditions; and

(bb) the runway that may be required for landing because of the forecast wind conditions:

Provided that if an alternate aerodrome is designated in the flight plan, the specified landing distance required may be that appropriate to an alternate aerodrome when assessing the ability of the aeroplane to satisfy this condition at the aerodrome of destination.

(b) For the purposes of sub-paragraph (a) hereof the landing distance required shall be that specified as being appropriate to—

(i) the landing weight;

(ii) the altitude at the aerodrome;

(iii) the temperature in the specified international standard atmosphere appropriate to the altitude at the aerodrome;

(iv) (aa) a level surface in the case of runways usable in both directions;

(bb) the average slope of the runway in the case of runways usable in only one direction; and

(v) (aa) still air conditions in the case of the most suitable runway for a landing in still air conditions;

(bb) not more than 50 per cent of the forecast wind component opposite to the direction of landing in the case of the runway that may be required for landing because of the forecast wind conditions.

Weight and Performance of Public Transport Aeroplanes classified as Aeroplanes of Performance Group C in their Certificate of Airworthiness

5. With reference to Article 29(1) of this Order an aeroplane registered in Hong Kong in respect of which there is in force under this Order a certificate of airworthiness in which the aeroplane is designated as being of performance group C shall not fly for the purpose of public transport unless

the weight of the aeroplane at the commencement of the take-off run is such that the following conditions are satisfied—

(1) That weight does not exceed the maximum take-off weight specified for the altitude and the air temperature at the aerodrome at which the take-off is to be made.

(2) The take-off run required and the take-off distance required, specified as being appropriate to—

- (a) the weight of the aeroplane at the commencement of the take-off run;
 - (b) the altitude of the aerodrome;
 - (c) the air temperature at the aerodrome;
 - (d) the average slope of the surface of the aerodrome in the direction of take-off over the emergency distance available; and
 - (e) not more than 50 per cent of the reported wind component opposite to the direction of take-off or not less than 150 per cent of the reported wind component in the direction of take-off, do not exceed the take-off run available and the emergency distance available, respectively, at the aerodrome at which the take-off is to be made.
- (a) (3) (a) Subject to condition (4) of this Regulation, the net take-off flight path with all power units operating specified as being appropriate to—
- (i) the weight of the aeroplane at the commencement of the take-off run;
 - (ii) the altitude at the aerodrome;
 - (iii) the air temperature at the aerodrome;
 - (iv) not more than 50 per cent of the reported wind component opposite to the direction of take-off or not less than 150 per cent of the reported wind component in the direction of take-off;

and plotted from a point 50 feet above the end of the take-off distance required at the aerodrome at which the take-off is to be made to a height of 1,500 feet above the aerodrome shows that the aeroplane will clear any obstacle in its path by a vertical interval of not less than 35 feet; and if it is intended that the aeroplane shall change its direction of flight by more than 15° before reaching 1500 feet the vertical interval shall be not less than 50 feet while the aircraft is changing direction.

- (b) For the purpose of sub-paragraph (a) hereof an obstacle shall be deemed to be in the path of the aeroplane if the distance from the obstacle to the nearest point on the ground below the intended line of flight of the aeroplane does not exceed 75 metres.
 - (c) In assessing the ability of the aeroplane to satisfy this condition, it shall not be assumed to make a change of direction of a radius less than the specified radius of steady turn.
- (a) (4) (a) In the case of an aeroplane which is intended to be flown for any period before reaching a height of 1500 feet above the aerodrome from which the take-off is to be made in conditions which will not ensure that any obstacles can be located by means of visual observation, the net take-off flight path with one power unit inoperative specified as being appropriate to the factors contained in sub-paragraphs (i) to (iv) of condition 3(a) in this Regulation and plotted from the point on the net take-off flight path with all power units operating specified as being appropriate to those factors at which in the meteorological conditions expected for the flight the loss of visual reference would occur, shows that the aeroplane will clear by a vertical interval of not less than 35 feet any obstacle in its path; and if it is intended that the aeroplane shall change its direction of flight by more than 15° the vertical interval shall not be less than 50 feet during the change of direction.

Status: This is the original version (as it was originally made). This item of legislation is currently only available in its original format.

- (b) For the purpose of sub-paragraph (a) hereof an obstacle shall be deemed to be in the path of the aeroplane if the distance from the obstacle to the nearest point on the ground below the intended line of flight of the aeroplane does not exceed—
- (i) 75 metres plus one eighth of the distance from such point to the end of the emergency distance available measured along the intended line of flight of the aeroplane; or
 - (ii) 900 metres,
- whichever is the less.

- (c) In assessing the ability of the aerodrome to satisfy this condition it shall not be assumed to make a change of direction of a radius less than the specified radius of steady turn.

(5) The aeroplane at any time after it reaches a height of 1,500 feet above the aerodrome from which the take-off is made will, in the meteorological conditions expected for the flight, in the event of any one power unit becoming inoperative at any point on its route or on any planned diversion therefrom, and with the other power unit or power units operating within the specified maximum continuous power conditions, be capable of continuing the flight at altitudes not less than the relevant minimum altitude for safe flight stated in, or calculated from the information contained in, the operations manual relating to the aeroplane to a point 1,500 feet above an aerodrome at which a safe landing can be made and after arrival at that point be capable of maintaining that height:

Provided that in assessing the ability of the aeroplane to satisfy this condition it shall not be assumed to be capable of flying at any point on its route at an altitude exceeding the performance ceiling, with all power units operating, specified as being appropriate to its estimated weight at that point.

(6) The landing weight of the aeroplane will not exceed the maximum landing weight specified for the altitude and the expected air temperature for the estimated time of landing at the aerodrome at which it is intended to land and at any alternate aerodrome.

(7) Subject to condition (8) of this Regulation, the distance required by the aeroplane to land from a height of 50 feet otherwise than in accordance with specified data for short field landing does not, at the aerodrome at which it is intended to land and at any alternate aerodrome, exceed 70 per cent of the landing distance available on the most suitable runway for a landing in still air conditions, and on the runway that may be required for landing because of the forecast wind conditions; and for the purposes of this condition the distance required to land from a height of 50 feet shall be taken to be that specified as being appropriate to—

- (a) the landing weight;
- (b) the altitude at the aerodrome;
- (c) the temperature in the specified international standard atmosphere appropriate to the altitude at the aerodrome;
- (d)
 - (i) a level surface in the case of runways usable in both directions;
 - (ii) the average slope of the runway in the case of runways usable in only one direction; and
- (e)
 - (i) still air conditions in the case of the most suitable runway for landing in still air conditions;
 - (ii) not more than 50 per cent of the forecast wind component opposite to the direction of landing or not less than 150 per cent of the forecast wind component in the direction of landing in the case of the runway that may be required for landing because of the forecast wind conditions.

(8) As an alternative to condition (7) of this Regulation, the distance required by the aeroplane, with all power units operating and with one power unit inoperative, to land in accordance with specified data for short field landing, does not at the aerodrome of intended destination and at

any alternate aerodrome exceed the landing distance available on the most suitable runway for a landing in still air conditions and on the runway that may be required for landing because of the forecast wind conditions; and for the purpose of this condition the distance required to land from the appropriate heights shall be taken to be that specified as being appropriate to the factors set forth in sub-paragraphs (a) to (e) of condition (7) of this Regulation and the appropriate height shall be—

- (a) for a landing with all power units operating—any height between 30 and 50 feet in Hong Kong and 50 feet elsewhere; and
- (b) for a landing with one power unit inoperative—50 feet in Hong Kong and elsewhere:

Provided that—

- (i) if the specified distance required to land with one power unit inoperative from a height of 50 feet at the aerodrome of intended destination exceeds the landing distance available, it shall be sufficient compliance with sub-paragraph (b) of this condition if an alternate aerodrome which has available the specified landing distance required to land with one power unit inoperative from such a height, is designated in the flight plan;
- (ii) the distance required by the aeroplane to land shall be determined in accordance with condition (7) and not in accordance with this condition if it is intended to land at night, or when the cloud ceiling or ground visibility forecast for the estimated time of landing at the aerodrome of intended destination and at any alternate aerodrome at which it is intended to land in accordance with specified data for short field landing with all power units operating are less than 500 feet and one nautical mile respectively.

Weight and Performance of Public Transport Aeroplanes Classified as Aeroplanes of Performance Group D in their Certificate of Airworthiness

6. With reference to Article 29(1) of this Order an aeroplane registered in Hong Kong in respect of which there is in force under this Order a certificate of airworthiness in which the aeroplane is designated as being of performance group D shall not fly for the purpose of public transport at night or when the cloud ceiling or visibility prevailing at the aerodrome of departure and forecast for the estimated time of landing at the aerodrome at which it is intended to land and at any alternate aerodrome are less than 1,000 feet and one nautical mile respectively and shall not fly for the purpose of public transport at any other time unless the weight of the aeroplane at the commencement of the take-off run is such that the following conditions are satisfied—

(1) That weight does not exceed the maximum take-off weight specified for the altitude and air temperature at the aerodrome at which the take-off is to be made.

(2) The take-off run required and the take-off distance required specified as being appropriate to—

- (a) the weight of the aeroplane at the commencement of the take-off run;
 - (b) the altitude at the aerodrome;
 - (c) the air temperature at the aerodrome;
 - (d) the average slope of the surface of the aerodrome in the direction of take-off over the emergency distance available; and
 - (e) not more than 50 per cent of the reported wind component opposite to the direction of take-off or not less than 150 per cent of the reported wind component in the direction of take-off.
- (a) (3) (a) The net take-off flight path with all power units operating, specified as being appropriate to—

- (i) the weight of the aeroplane at the commencement of the take-off run;

Status: This is the original version (as it was originally made). This item of legislation is currently only available in its original format.

- (ii) the altitude at the aerodrome;
- (iii) the air temperature at the aerodrome; and
- (iv) not more than 50 per cent of the reported wind component opposite to the direction of take-off or not less than 150 per cent of the reported wind component in the direction of take-off, and plotted from a point 50 feet above the end of the take-off distance required at the aerodrome at which the take-off is to be made to the point at which the aeroplane reaches a height of 1000 feet above the aerodrome shows that the aeroplane will clear any obstacle in its path by a vertical interval of not less than 35 feet except that if it is intended that the aeroplane shall change its direction of flight by more than 15° before reaching 1000 feet the vertical interval shall be not less than 50 feet while the aircraft is changing direction.

(b) For the purpose of sub-paragraph (a) hereof an obstacle shall be deemed to be in the path of the aeroplane if the distance from the obstacle to the nearest point on the ground below the intended line of flight of the aeroplane does not exceed 75 metres.

(c) In assessing the ability of the aeroplane to satisfy this condition it shall not be assumed to make a change of direction of a radius less than the specified radius of steady turn.

(4) The aeroplane, at any time after it reaches a height of 1,000 feet above the aerodrome from which take-off is to be made, will, in the meteorological conditions expected for the flight, in the event of any one power unit becoming inoperative at any point on its route or on any planned diversion therefrom, and with the other power unit or power units, if any, operating within the maximum specified continuous power conditions, be capable of continuing the flight at altitudes not less than the relevant minimum altitudes for safe flight stated in, or calculated from the information contained in, the operations manual relating to the aeroplane to a point 1,000 feet above a place at which a safe landing can be made:

Provided that in assessing the ability of the aeroplane to satisfy this condition it shall not be assumed to be capable of flying at any point on its route at an altitude exceeding the performance ceiling with all power units operating specified as being appropriate to its estimated weight at that point.

(5) The landing weight of the aeroplane will not exceed the maximum landing weight specified for the altitude and the expected air temperature for the estimated time of landing at the aerodrome at which it is intended to land and at any alternate aerodrome.

(6) The distance required by the aeroplane to land from a height of 50 feet does not, at the aerodrome at which it is intended to land and at any alternate aerodrome, exceed 70 per cent of the landing distance available on the most suitable runway for a landing in still air conditions, and on the runway that may be required for landing because of the forecast wind conditions; and for the purposes of a runway that may be required for this condition the distance required to land from a height of 50 feet shall be taken to be that specified as being appropriate to—

- (a) the landing weight;
- (b) the altitude at the aerodrome;
- (c) the temperature in the specified international standard atmosphere appropriate to the altitude at the aerodrome;
- (d) (i) a level surface in the case of runways usable in both directions;
- (ii) the average slope of the runway in the case of runways usable in only one direction;
- and
- (e) (i) still air conditions in the case of the most suitable runway for a landing in still air conditions;

Status: This is the original version (as it was originally made). This item of legislation is currently only available in its original format.

- (ii) not more than 50 per cent of the forecast wind component opposite to the direction of landing or not less than 150 per cent of the forecast wind component in the direction of landing in the case of the runway that may be required for landing because of the forecast wind conditions.

Weight and Performance of Public Transport Aeroplanes classified as Aeroplanes of Performance Group E in their Certificates of Airworthiness

7.—(1) With reference to Article 29(1) of this Order an aeroplane registered in Hong Kong in respect of which there is in force under this Order a certificate of airworthiness in which the aeroplane is designated as being of performance group E shall not fly for the purpose of public transport unless the weight of the aeroplane at the commencement of the take-off run is such that the following conditions are satisfied—

- (a) that weight for the altitude and the air temperature at the aerodrome at which the take-off is to be made does not exceed the maximum take-off weight specified as being appropriate to—
 - (i) the weight at which the aeroplane is capable in the en-route configuration and with all power units operating within the specified maximum continuous power conditions of a rate of climb of 700 feet per minute if it has retractable landing gear and of 500 feet per minute if it has fixed landing gear; and
 - (ii) the weight at which the aeroplane is capable, in the en-route configuration and if it is necessary for it to be flown solely by reference to instruments for any period before reaching the minimum altitude for safe flight on the first stage of the route to be flown, stated in, or calculated from the information contained in, the operations manual relating to the aeroplane and, with one power unit inoperative, of a rate of climb of 150 feet per minute.
- (b) The distance required by the aeroplane to attain a height of 50 feet, with all power units operating within the maximum take-off power conditions specified, when multiplied by a factor of 1.33 does not exceed the emergency distance available at the aerodrome at which the take-off is to be made. The distance required by the aeroplane to attain a height of 50 feet shall be that appropriate to—
 - (i) the weight of the aeroplane at the commencement of the take-off run;
 - (ii) the altitude at the aerodrome;
 - (iii) the air temperature at the aerodrome; and
 - (iv) not more than 50 per cent of the reported wind component opposite to the direction of take-off or not less than 150 per cent of the reported wind component in the direction of take-off.
- (c) The aeroplane will, in the meteorological conditions expected for the flight, in the event of any one power unit becoming inoperative at any point on its route or on any planned diversion therefrom, and with the other power unit or power units, if any, operating within the specified maximum continuous power conditions, be capable of continuing the flight at altitudes not less than the relevant minimum altitude for safe flight stated in, or calculated from the information contained in, the operations manual to a point 1000 feet above a place at which a safe landing can be made:

Provided that in assessing the ability of the aeroplane to satisfy this condition it shall not be assumed to be capable of flying at any point on its route or on any planned diversion therefrom at an altitude exceeding that at which it is capable of a rate of climb with all power units operating within the maximum continuous power conditions specified of 150 feet per minute and if it is necessary for it to be flown

Status: This is the original version (as it was originally made). This item of legislation is currently only available in its original format.

solely by reference to instruments, be capable with one power unit inoperative, of a rate of climb of 100 feet per minute.

- (d) The landing weight of the aeroplane for the altitude and the expected air temperature for the estimated time of landing at the aerodrome at which it is intended to land and at any alternate aerodrome will not exceed the maximum landing weight specified—
- (i) at which the aeroplane is capable, in the en-route configuration and with all power units operating within the specified maximum continuous power conditions of a rate of climb of 700 feet per minute if it has retractable landing gear and of 500 feet per minute if it has fixed landing gear; and
 - (ii) at which the aeroplane is capable in the en-route configuration and if it is necessary for it to be flown solely by reference to instruments for any period after leaving the minimum altitude for safe flight on the last stage of the route to be flown, stated in, or calculated from the information contained in, the operations manual relating to the aeroplane and with one power unit inoperative, of a rate of climb of 150 feet per minute.

(2) An aeroplane designated as aforesaid as an aeroplane of performance group E shall not fly for the purpose of public transport at night or when the cloud ceiling or visibility prevailing at the aerodrome of departure and forecast for the estimated time of landing at the aerodrome at which it is intended to land and at any alternate aerodrome are less than 1000 feet and one nautical mile respectively:

Provided that the foregoing prohibition shall not apply if the aeroplane is capable, in the en-route configuration and with one power unit inoperative, of a rate of climb of 150 feet per minute.

Weight and Performance of Public Transport Aeroplanes classified as Aeroplanes of Performance Group X in their Certificates of Airworthiness

8. With reference to Article 29(1) of this Order an aeroplane in respect of which there is in force under this Order a certificate of airworthiness designating the aeroplane as being of performance group X shall not fly for the purpose of public transport unless the weight of the aeroplane at the commencement of the take-off run is such that the following conditions are satisfied:

- (i) (1) (i) That weight does not exceed the maximum take-off weight specified for the altitude at the aerodrome at which the take-off is to be made, or for the altitude and the air temperature at such aerodrome, as the case may be.
- (ii) The minimum effective take-off runway length required specified as being appropriate to—
 - (a) the weight of the aeroplane at the commencement of the take-off run;
 - (b) the altitude at the aerodrome;
 - (c) the air temperature at the time of take-off;
 - (d) the condition of the surface of the runway from which the take-off will be made;
 - (e) the overall slope of the take-off run available; and
 - (f) not more than 50 per cent of the reported wind component opposite to the direction of take-off or not less than 150 per cent of the reported wind component in the direction of take-off,

does not exceed the take-off run available at the aerodrome at which the take-off is to be made.

- (iii) (a) The take-off flight path with one power unit inoperative, specified as being appropriate to—

Status: This is the original version (as it was originally made). This item of legislation is currently only available in its original format.

- (aa) the weight of the aeroplane at the commencement of the take-off run;
- (bb) the altitude at the aerodrome; and
- (cc) not more than 50 per cent of the reported wind component opposite to the direction of take-off or not less than 150 per cent of the reported wind component in the direction of take-off,

and plotted from a point 50 feet above the end of the minimum effective take-off runway length required at the aerodrome at which the take-off is to be made, shows that the aeroplane will thereafter clear any obstacle in its path by a vertical interval of not less than the greater of 50 feet or 35 feet plus one-hundredth of the distance from the point on the ground below the intended line of flight of the aeroplane nearest to the obstacle to the end of the take-off distance available, measured along the intended line of flight of the aeroplane.

- (b) For the purpose of sub-paragraph (a) an obstacle shall be deemed to be in the path of the aeroplane if the distance from the obstacle to the nearest point on the ground below the intended line of flight does not exceed—
 - (aa) a distance of 60 metres plus half the wing span of the aeroplane plus one-eighth of the distance from such point to the end of the take-off distance available measured along the intended line of flight; or
 - (bb) 900 metres,whichever is the less.

- (c) In assessing the ability of the aeroplane to satisfy this condition, insofar as it relates to flight path, it shall not be assumed to make a change of direction of a radius less than the radius of steady turn corresponding to an angle of bank of 15°.

- (i) (a) Subject to sub-paragraph (b), the weight of the aeroplane at any point on the route or any planned diversion therefrom, having regard to the fuel and oil expected to be consumed up to that point, shall be such that the aeroplane with one power unit inoperative and the other power unit or units operating within the maximum continuous power conditions specified, will be capable of a rate of climb of at least $K(V_{so}/100)^2$ feet per minute at an altitude not less than the minimum altitude for safe flight stated in or calculated from the information contained in the operations manual where V_{so} is in knots and K has the value of $797-1060/N$, N being the number of power units installed.
- (b) As an alternative to (a) the aeroplane may be flown at an altitude from which, in the event of failure of one power unit, it is capable of reaching an aerodrome where a landing can be made in accordance with condition (3)(ii) in this Regulation relating to an alternate aerodrome. In that case the weight of the aeroplane shall be such that, with the remaining power unit or units operating within the maximum continuous power conditions specified, it is capable of maintaining a minimum altitude on the route to such aerodrome of 2000 feet above all obstacles within 10 nautical miles on either side of the intended track:

Provided that where the operator of the aeroplane is satisfied, taking into account the navigation aids which can be made use of by the aeroplane on the route that the commander of the aeroplane will be able to maintain his intended track on that route within a margin of 5 nautical miles, the foregoing provisions of this sub-paragraph shall have effect as if 5 nautical miles were substituted therein for 10 nautical miles and

Status: This is the original version (as it was originally made). This item of legislation is currently only available in its original format.

- (aa) the rate of climb, specified for the appropriate weight and altitude, used in calculating the flight path shall be reduced by an amount equal to $K(V_{so}/100)^2$ feet per minute;
 - (bb) the aeroplane shall comply with the climb requirements of condition (2)(i)(a) at 1000 feet above the chosen aerodrome;
 - (cc) account shall be taken of the effect of wind and temperature on the flight path; and
 - (dd) the weight of the aeroplane may be assumed to be progressively reduced by normal consumption of fuel and oil.
- (ii) An aeroplane having four power units shall, if any two power units become inoperative at any point along the route or any planned diversion therefrom, being a point more than 90 minutes flying time (assuming all power units to be operating) from the nearest aerodrome at which a landing can be made in compliance with condition (3)(ii) of this Regulation relating to an alternate aerodrome be capable of continuing the flight at an altitude of not less than 1000 feet above ground level to a point above that aerodrome. In assessing the ability of the aeroplane to satisfy this condition, it shall be assumed that the remaining power units will operate within the specified maximum continuous power conditions, and account shall be taken of the temperature and wind conditions expected for the flight.
- (i) (3) (i) The landing weight of the aeroplane will not exceed the maximum landing weight specified for the altitude at the aerodrome at which it is intended to land and at any alternate aerodrome.
- (ii) The required landing runway lengths respectively specified as being appropriate to the aerodromes of intended destination and the alternate aerodromes do not exceed at the aerodrome at which it is intended to land or at any alternate aerodrome, as the case may be, the landing distance available on—
- (a) the most suitable runway for landing in still air conditions; and
 - (b) the runway that may be required for landing because of the forecast wind conditions, the required landing runway lengths being taken to be those specified as being appropriate to—
 - (aa) the landing weight;
 - (bb) the altitude at the aerodrome;
 - (cc) still air conditions in the case of the most suitable runway for a landing in still air conditions; and
 - (dd) not more than 50 per cent of the forecast wind component opposite to the direction of landing or not less than 150 per cent of the forecast wind component in the direction of landing in the case of the runway that may be required for landing because of the forecast wind conditions.

Weight and Performance of Public Transport Helicopters classified as Helicopters of Performance Group A in their Certificate of Airworthiness

9. With reference to Article 29(1) of this Order a helicopter registered in Hong Kong in respect of which there is in force under the Order a Certificate of Airworthiness in which the helicopter is designated as being of performance Group A shall not fly for the purpose of public transport unless the weight of the helicopter at the commencement of take-off is such that the following conditions are satisfied:

- (1) The weight does not exceed the maximum take-off weight specified for the altitude and the air temperature at the site from which the take-off is to be made.

(2) The landing weight of the helicopter will not exceed the maximum landing weight specified for the altitude and the expected air temperature for the estimated time of landing at the site at which it is intended to land and at any alternate site.

Weight and Performance of Public Transport Helicopters classified as Helicopters of Performance Group A (Restricted) in their Certificate of Airworthiness

10. With reference to Article 29(1), a helicopter registered in Hong Kong in respect of which there is in force under the Order a certificate of airworthiness in which the helicopter is designated as being of performance group A (restricted) shall not fly for the purpose of public transport when the cloud ceiling or visibility prevailing at the departure site and forecast for the estimated time of landing at the site at which it is intended to land and at any alternate site are less than 500 feet and 1000 metres respectively and shall not fly for the purpose of public transport at any other time unless the weight of the helicopter at the commencement of take off is such that the following conditions are satisfied:

(1) The weight does not exceed the maximum take-off weight specified for the altitude and the air temperature at the site from which the take-off is to be made.

(2) The landing weight of the helicopter will not exceed the maximum landing weight specified for the altitude and the expected air temperature for the estimated time of landing at the site at which it is intended to land and at any alternate site.

Weight and Performance of Public Transport Helicopters classified as Helicopters of Performance Group B in their Certificate of Airworthiness

11. With reference to Article 29(1) of this Order a helicopter registered in Hong Kong in respect of which there is in force under this Order a Certificate of Airworthiness in which the helicopter is designated as being of performance Group B shall not fly for the purpose of public transport at night or out of sight of the surface or when the cloud ceiling or visibility prevailing at the departure site and forecast for the estimated time of landing at the site at which it is intended to land are less than 600 feet and 1,000 metres respectively and shall not fly for the purpose of public transport at any other time unless the weight of the helicopter at the commencement of take-off is such that the following conditions are satisfied:

(1) The weight does not exceed the maximum take-off weight specified for the altitude and the air temperature at the site at which the take-off is to be made.

(2) The landing weight of the helicopter will not exceed the maximum landing weight specified for the altitude and the expected air temperature for the estimated time of landing at the site at which it is intended to land and at any alternate site.

Noise and Vibration caused by Aircraft on Aerodromes

12. With reference to Article 78 of this Order, the conditions under which noise and vibration may be caused by aircraft (including military aircraft) on Government aerodromes, licensed aerodromes or on aerodromes at which the manufacture, repair or maintenance of aircraft is carried out by persons carrying on business as manufacturers or repairers of aircraft, shall be as follows, that is to say, that, whether in the course of the manufacture of the aircraft or otherwise—

- (a) the aircraft is taking off or landing; or
- (b) the aircraft is moving on the ground or water; or
- (c) the engines are being operated in the aircraft—
 - (i) for the purpose of ensuring their satisfactory performance;

Status: This is the original version (as it was originally made). This item of legislation is currently only available in its original format.

- (ii) for the purpose of bringing them to a proper temperature in preparation for, or at the end of, a flight; or
- (iii) for the purpose of ensuring that the instruments, accessories or other components of the aircraft are in a satisfactory condition.

Certificates of Maintenance Review and Release to Service issue by Maintenance Engineers licensed by Prescribed Countries

13. With reference to Article 9(3)(a)(iii) and Article 11(6)(a)(iii) of the Order the following country is hereby prescribed—

United Kingdom

Aeroplanes Flying for the Purpose of Public Transport of Passengers—Aerodrome Facilities for Approach to Landing and Landing

14.—(1) This Regulation shall apply to every aeroplane registered in Hong Kong engaging on a flight for the purpose of the public transport of passengers on a scheduled journey and to every aeroplane so registered whose maximum total weight authorised exceeds 5700 kg engaging on such a flight otherwise than on a scheduled journey.

(2) For the purposes of Article 27(1)(c) of this Order, the following manning and equipment are prescribed in relation to aerodromes intended to be used for landing or as an alternate aerodrome by aircraft to which this Regulation applies—

- (a) air traffic control service or aerodrome flight information service, including the reporting to aircraft of the current meteorological conditions at the aerodrome;
- (b) very high frequency radiotelephony;
- (c) at least one of the following radio navigation aids, either at the aerodrome or elsewhere, and in either case for the purpose of assisting the pilot in locating the aerodrome and making an approach to landing there—
 - (i) radio direction finding equipment utilising emissions in the very high frequency bands;
 - (ii) a non-directional radio beacon transmitting signals in the low or medium frequency bands;
 - (iii) very high frequency omni-directional radio range;
 - (iv) radar equipment.

It shall be sufficient if the equipment specified in sub-paragraph (c) is provided, even if for the time being it is not in operation.

(3) An aircraft to which this Regulation applies shall not land or make an approach to landing at any aerodrome unless services and equipment according with paragraph (2) of this Regulation are provided and are in operation at that aerodrome, and can be made use of by that aircraft, and, in the case of the navigation aids specified in sub-paragraph (c), items (i) to (iv), instructions and procedures for the use of the aid are included in the operations manual. A person shall be deemed not to have contravened the provisions of this paragraph if he proves that—

- (a) for the time being use could not be made of the radio navigation aids provided under paragraph (2)(c) whether by reason of those aids not being in operation or of the unserviceability of equipment in the aircraft itself; and
- (b) the approach to landing was made in accordance with instructions and procedures appropriate to that circumstance and included in the operations manual.

(4) An aircraft to which this Regulation applies shall be equipped with the equipment necessary to enable use to be made of at least one of the navigation aids specified in paragraph (2)(c) of this Regulation and in use for landing at the aerodrome. Nothing in this paragraph shall require the duplication of any equipment carried in pursuance of any other provision of this Order of any regulation made thereunder.

Pilot Maintenance—Prescribed Repair or Replacements

15. With reference to Article 11(3) of this Order the following repairs or replacements are hereby prescribed—

(1) Repairs to upholstery and decorative furnishing of the cabin or cockpit interior when repair does not require dismantling of any structure or operating system or interfere with an operating system or affect the structure of the aircraft;

(2) Replacement of seats or seat parts not involving dismantling of any structure or of any operating system.

Mandatory Reporting—Prescribed Reportable Occurrences, Time and Manner of Reporting and Information to be reported

16.—(1) With reference to Article 86(1) of this Order, the following reportable occurrences are hereby prescribed, that is to say those—

- (a) involving damage to an aircraft;
- (b) involving injury to a person;
- (c) involving the impairment during a flight of the capacity of a member of the flight crew of an aircraft to undertake the functions to which his licence relates;
- (d) involving the use in flight of any procedures taken for the purpose of overcoming an emergency;
- (e) involving the failure of an aircraft system or of any equipment of an aircraft;
- (f) arising from the control of an aircraft in flight by its flight crew;
- (g) arising from failure or inadequacy of facilities or services on the ground used or intended to be used for purposes of or in connection with the operation of aircraft;
- (h) arising from the loading or the carriage of passengers, cargo (including mail) or fuel;

and those which are not referred to in sub-paragraphs (a) to (h) of this paragraph of this Regulation but which, in the opinion of a person referred to in sub-paragraphs (a) to (e) of Article 86(1) of this Order, constitute an occurrence endangering, or which if not corrected would endanger, the safety of an aircraft, its occupants or any other person.

(2) For the purposes of this Regulation, an aircraft system includes the flight control, power plant, fuel, hydraulic, pneumatic, pressurisation, electrical, navigation and any other system of the aircraft.

(3) With reference to Article 86(1) of this Order, it is hereby prescribed that a report containing the information referred to in paragraph (4) of this Regulation shall be despatched in writing and by the quickest available means to the Governor within 96 hours of the reportable occurrence coming to the knowledge of the person making the report:

Provided that, if at that time any of the said information is not in the possession of that person, he shall despatch that information to the Governor in writing and by the quickest available means with 96 hours of it coming into his possession.

(4) With reference to Article 86(1) of this Order, a report shall, as far as possible, contain the following information:

- (a) the type, series and registration marks of the aircraft concerned;

Status: This is the original version (as it was originally made). This item of legislation is currently only available in its original format.

- (b) the name of the operator of the aircraft;
- (c) the date of the reportable occurrence;
- (d) if the person making the report has instituted an investigation into the reportable occurrence, whether or not this has been completed;
- (e) a description of the reportable occurrence, including its effects and any other relevant information;
- (f) in the case of a reportable occurrence which occurs during flight—
 - (i) the Greenwich Mean Time of the occurrence;
 - (ii) the last point of departure and the next point of intended landing of the aircraft at that time;
 - (iii) the geographical position of the aircraft at that time;
- (g) in the case of a defect in or malfunctioning of an aircraft or any part or equipment of an aircraft, the name of the manufacturer of the aircraft, part or equipment, as the case may be, and, where appropriate, the part number and modification standard of the part or equipment and its location on the aircraft;
- (h) the signature and name in block capitals of the person making the report, the name of his employer and the capacity in which he acts for that employer;
- (i) in the case of a report made by the commander of an aircraft or a person referred to in subparagraph (c) or (d) of Article 86(1) of this Order the address or telephone number at which communications should be made to him, if different from that of his place of employment.

Minimum Navigation Performance Specifications—Prescribed Airspace and Navigation Performance Capability

17.—(1) With reference to Article 36 of this Order the following navigation performance capability is hereby prescribed, that is to say, a capability to ensure that—

- (a) the standard deviation of lateral errors in the track of the aircraft is not more than 6.3 nautical miles; and
- (b) the proportion of the flight time of the aircraft during which the actual track of the aircraft is 30 nautical miles or more off the track along which it has been given an air traffic control clearance to fly is less than 5.3×10^{-4} ; and
- (c) the proportion of the flight time of the aircraft during which the actual track of the aircraft is between 50 and 70 nautical miles off the track along which it has been given an air traffic control clearance to fly is less than 13×10^{-5} .

(2) For the purposes of Article 36 of this Order the following airspace is hereby prescribed, that is to say, the airspace from flight level 275 to flight level 400 within the area defined by rhumb lines joining successively the following points—

34°10'N 17°48'W	65°00'N 60°00'W
36°30'N 15°00'W	64°00'N 63°00'W
42°00'N 15°00'W	61°00'N 63°00'W
43°00'N 13°00'W	57°00'N 59°00'W
45°00'N 13°00'W	53°00'N 54°00'W
45°00'N 08°00'W	49°00'N 51°00'W
51°00'N 08°00'W	45°00'N 51°00'W

51°00'N 15°00'W	45°00'N 53°00'W
54°00'N 15°00'W	43°36'N 60°00'W
54°34'N 10°00'W	41°52'N 67°00'W
61°00'N 10°00'W	39°00'N 67°00'W
61°00'N 00°00'	38°35'N 68°53'W
82°00'N 00°00'	38°30'N 69°15'W
82°00'N 30°00'E	38°30'N 60°00'W
North Pole	27°00'N 60°00'W
82°00'N 60°00'W	27°00'N 25°00'W
78°00'N 75°00'W	30°00'N 25°00'W
76°00'N 76°00'W	30°00'N 20°00'W
65°00'N 76°45'W	31°39'N 17°25'W

thence by that part of the arc of a circle radius 100 nautical miles centred on 33°04'N 16°21'W to 34°10'N 17°48'W

Regulation 3

ANNEX TO SCHEDULE 15

WEIGHT AND PERFORMANCE OF PUBLIC TRANSPORT AEROPLANES HAVING NO PERFORMANCE GROUP CLASSIFICATION IN THEIR CERTIFICATE OF AIRWORTHINESS

Conditions (1) and (2) apply to all aeroplanes to which Regulation 3 applies;

Conditions (3) to (10) apply to all aeroplanes to which Regulation 3 applies—

(i) of which the specified maximum total weight authorised exceeds 5700 kg, or

(ii) of which the specified maximum total weight authorised does not exceed 5700 kg and which comply with neither condition (1)(a) nor condition (1)(b);

Conditions (11) to (18) inclusive apply to all aeroplanes to which Regulation 3 applies of which the specified maximum total weight authorised does not exceed 5700 kg and which comply with condition (1)(a) or condition (1)(b) or with both those conditions.

All aeroplanes

(1) Either—

(a) the wing loading of the aeroplane does not exceed 20 lb per square foot; or

(b) the stalling speed of the aeroplane in the landing configuration does not exceed 60 knots; or

(c) the aeroplane, with any one of its power units inoperative and the remaining power unit or units operating within the maximum continuous power conditions specified, is capable of a gradient of climb of at least 1 in 200 at an altitude of 5000 feet in the specified international standard atmosphere.

(2) The weight of the aeroplane at the commencement of the take-off run does not exceed the maximum take-off weight, if any, specified for the altitude and the air temperature at the aerodrome at which the take-off is to be made.

Status: This is the original version (as it was originally made). This item of legislation is currently only available in its original format.

Aeroplanes of a specified maximum total weight authorised exceeding 5700 kg and aeroplanes of a specified maximum total weight authorised not exceeding 5700 kg which comply with neither condition (1)(a) nor condition (1)(b).

- (a) (3) (a) The distance required by the aeroplane to attain a height of 50 feet, with all power units operating within the maximum take-off power conditions specified, does not exceed the take-off run available at the aerodrome at which the take-off is to be made.
- (b) The distance required by the aeroplane to attain a height of 50 feet with all power units operating within the maximum take-off power conditions specified, when multiplied by a factor of either 1.33 for aeroplanes having two power units or by a factor of 1.18 for aeroplanes having four power units, does not exceed the emergency distance available at the aerodrome at which the take-off is to be made.
- (c) For the purposes of sub-paragraphs (a) and (b) the distance required by the aeroplane to attain a height of 50 feet shall be that appropriate to—
 - (i) the weight of the aeroplane at the commencement of the take-off run;
 - (ii) the altitude at the aerodrome;
 - (iii) the air temperature at the aerodrome;
 - (iv) the condition of the surface of the runway from which the take-off will be made;
 - (v) the slope of the surface of the aerodrome in the direction of take-off over the take-off run available and the emergency distance available, respectively; and
 - (vi) not more than 50 per cent of the reported wind component opposite to the direction of take-off or not less than 150 per cent of the reported wind component in the direction of take-off.
- (a) (4) (a) The take-off flight path with one power unit inoperative and the remaining power unit or units operating within the maximum take-off power conditions specified, appropriate to—
 - (i) the weight of the aeroplane at the commencement of the take-off run;
 - (ii) the altitude at the aerodrome;
 - (iii) the air temperature at the aerodrome;
 - (iv) not more than 50 per cent of the reported wind component opposite to the direction of take-off or not less than 150 per cent of the reported wind component in the direction of take-off,

and plotted from a point 50 feet above the end of the appropriate factored distance required for take-off under condition (3)(b) of this Annex at the aerodrome at which the take-off is to be made, shows that the aeroplane will clear any obstacle in its path by a vertical interval of at least 35 feet except that if it is intended that an aeroplane shall change its direction by more than 15° the vertical interval shall be not less than 50 feet during the change of direction.

- (b) For the purpose of sub-paragraph (4)(a) an obstacle shall be deemed to be in the path of the aeroplane if the distance from the obstacle to the nearest point on the ground below the intended line of flight does not exceed—
 - (i) a distance of 60 metres plus half the wing span of the aeroplane, plus one-eighth of the distance from such point to the end of the take-off distance available, measured along the intended line of flight; or
 - (ii) 900 metres
 whichever is the less

- (c) In assessing the ability of the aeroplane to satisfy this condition, it shall not be assumed to make a change of direction of a radius less than a radius of steady turn corresponding to an angle of bank of 15°.

(5) The aeroplane will, in the meteorological conditions expected for the flight, in the event of any one power unit becoming inoperative at any point on its route or on any planned diversion therefrom and with the other power unit or units operating within the maximum continuous power conditions specified, be capable of continuing the flight clearing obstacles within 10 nautical miles either side of the intended track by a vertical interval of at least:

- (a) 1,000 feet when the gradient of the flight path is not less than zero; or
- (b) 2,000 feet when the gradient of the flight path is less than zero,

to an aerodrome at which it can comply with condition (9), and on arrival over such aerodrome the flight path shall have a gradient of not less than zero at 1,500 feet above the aerodrome.

For the purpose of this condition the gradient of climb of the aeroplane shall be taken to be one per cent less than that specified.

(6) The aeroplane will, in the meteorological conditions expected for the flight, at any point on its route or on any planned diversion therefrom, be capable of climbing at a gradient of at least 1 in 50, with all power units operating within the maximum continuous power conditions, specified at the following altitudes—

- (a) the minimum altitudes for safe flight on each stage of the route to be flown or of any planned diversion therefrom specified in, or calculated from the information contained in, the operations manual relating to the aeroplane; and
- (b) the minimum altitudes necessary for compliance with conditions (5) and (7), as appropriate.

(7) If, on the route to be flown or any planned diversion therefrom, the aeroplane will be engaged in a flight over water during which at any point it may be more than 90 minutes flying time in still air from the nearest shore, it will in the event of two power units becoming inoperative during such time and with the other power unit or units operating within the maximum continuous power conditions specified be capable of continuing the flight having regard to the meteorological conditions expected for the flight, clearing all obstacles within 10 nautical miles either side of the intended track by a vertical interval of at least 1,000 feet, to an aerodrome at which a safe landing can be made.

(8) The landing weight of the aeroplane will not exceed the maximum landing weight, if any, specified for the altitude and the expected air temperature for the estimated time of landing at the aerodrome at which it is intended to land and at any alternate aerodrome.

(9) The distance required by the aeroplane to land from a height of 50 feet does not, at the aerodrome at which it is intended to land, exceed 60 per cent of the landing distance available on—

- (i) the most suitable runway for a landing in still air conditions; and
- (ii) the runway that may be required for landing because of the forecast wind conditions; provided that if an alternative aerodrome is designated in the flight plan the landing distance required at the aerodrome at which it is intended to land shall not exceed 70 per cent of that available on the runway.

The distance required to land from a height of 50 feet shall be taken to be that appropriate to—

- (a) the landing weight;
- (b) the altitude at the aerodrome;
- (c) the temperature in the specified international standard atmosphere appropriate to the altitude at the aerodrome;
- (d) (i) a level surface in the case of runways usable in both directions;

Status: This is the original version (as it was originally made). This item of legislation is currently only available in its original format.

- (ii) the average slope of the runway in the case of runways usable in only one direction; and
- (e) (i) still air conditions in the case of the most suitable runway for a landing in still air conditions; and
- (ii) not more than 50 per cent of the forecast wind component opposite to the direction of landing or not less than 150 per cent of the forecast wind component in the direction of landing in the case of the runway that may be required for landing because of the forecast wind conditions.

(10) The distance required by the aeroplane to land from a height of 50 feet does not, at any alternate aerodrome, exceed 70 per cent of the landing distance available on—

- (i) the most suitable runway for a landing in still air conditions; and
- (ii) the runway that may be required for landing because of the forecast wind conditions.

For the purpose of these conditions the distance required to land from a height of 50 feet shall be determined in the manner provided in condition (9).

Aeroplanes of a specified maximum total weight authorised not exceeding 5,700 kg and which comply with either condition (1)(a) or condition (1)(b), or with both these conditions.

(11) If the aeroplane is engaged in a flight at night or when the cloud ceiling or visibility prevailing at the aerodrome of departure and forecast for the estimated time of landing at the aerodrome of destination or at any alternate aerodrome are less than 1,000 feet and one nautical mile respectively, it will, with any one of its power units inoperative and the remaining power unit or units operating within the maximum continuous power conditions specified, be capable of climbing at a gradient of at least 1 in 200 at an altitude of 2,500 feet in the specified international standard atmosphere.

- (a) (12) (a) The distance required by the aeroplane to attain a height of 50 feet, with all power units operating within the maximum take-off power conditions specified, does not exceed the take-off run available at the aerodrome at which the take-off is to be made;
- (b) The distance required by the aeroplane to attain a height of 50 feet, with all power units operating within the maximum take-off power conditions specified, when multiplied by a factor of 1.33 does not exceed the emergency distance available at the aerodrome at which the take-off is to be made;
- (c) For the purposes of sub-paragraphs (a) and (b) the distance required by the aeroplane to attain a height of 50 feet shall be that appropriate to—
 - (i) the weight of the aeroplane at the commencement of the take-off run;
 - (ii) the altitude at the aerodrome;
 - (iii) the temperature in the specified international standard atmosphere appropriate to the altitude at the aerodrome or, if greater, the air temperature at the aerodrome less 15° centigrade;
 - (iv) the slope of the surface of the aerodrome in the direction of take-off over the take-off run available and the emergency distance available respectively; and
 - (v) not more than 50 per cent of the reported wind component opposite to the direction of take-off or not less than 150 per cent of the reported wind component in the direction of take-off.

(13) The take-off flight path, with all power units operating within the maximum take-off power conditions specified, appropriate to—

- (i) the weight of the aeroplane at the commencement of the take-off run;
- (ii) the altitude at the aerodrome;

- (iii) the temperature in the specified international standard atmosphere appropriate to the altitude at the aerodrome, or, if greater, the air temperature at the aerodrome less 15° centigrade; and
- (iv) not more than 50 per cent of the reported wind component opposite to the direction of take-off or not less than 150 per cent of the reported wind component in the direction of take-off, and plotted from a point 50 feet above the end of the factored distance required for take-off under condition (12)(b), at the aerodrome at which the take-off is to be made, shows that the aeroplane will clear any obstacle lying within 60 metres plus half the wing span of the aeroplane on either side of its path by a vertical interval of at least 35 feet. In assessing the ability of the aeroplane to satisfy this condition it shall not be assumed to make a change of direction of a radius less than a radius of steady turn corresponding to an angle of bank of 15°.

(14) The aeroplane will, in the meteorological conditions expected for the flight, in the event of any one power unit becoming inoperative at any point on its route or on any planned diversion therefrom and with the other power unit or units, if any, operating within the maximum continuous power conditions specified, be capable of continuing the flight so as to reach a point above a place at which a safe landing can be made at a suitable height for such landing.

(15) The aeroplane will, in the meteorological conditions expected for the flight, at any point on its route or any planned diversion therefrom, be capable of climbing at a gradient of at least 1 in 50, with all power units operating within the maximum continuous power conditions specified at the following altitudes—

- (a) the minimum altitudes for safe flight on each stage of the route to be flown or on any planned diversion therefrom specified in, or calculated from, the information contained in the operations manual relating to the aeroplane; and
- (b) the minimum altitudes necessary for compliance with condition (14).

(16) If on the route to be flown or any planned diversion therefrom the aeroplane will be engaged in a flight over water during which at any point it may be more than 30 minutes flying time in still air from the nearest shore, it will, in the event of one power unit becoming inoperative during such time and with the other power unit or units operating within the maximum continuous power conditions specified, be capable of climbing at a gradient of at least 1 in 200 at an altitude of 5,000 feet in the specified international standard atmosphere.

(17) The landing weight of the aeroplane will not exceed the maximum landing weight, if any, specified for the altitude and the expected air temperature for the estimated time of landing at the aerodrome at which it is intended to land and at any alternate aerodrome.

(18) The distance required by the aeroplane to land from a height of 50 feet does not at the aerodrome at which it is intended to land and at any alternate aerodrome exceed 70 per cent, or, if a visual approach and landing will be possible in the meteorological conditions forecast for the estimated time of landing, 80 per cent of the landing distance available on—

- (i) the most suitable runway for a landing in still air conditions; and
- (ii) the runway that may be required for landing because of the forecast wind conditions.

The distance required to land from a height of 50 feet shall be taken to be that appropriate to—

- (a) the landing weight;
- (b) the altitude at the aerodrome;
- (c) the temperature in the specified international standard atmosphere appropriate to the altitude at the aerodrome;
- (d) (i) a level surface in the case of runways usable in both directions;

Status: This is the original version (as it was originally made). This item of legislation is currently only available in its original format.

- (ii) the average slope of the runway in the case of runways usable in only one direction; and
- (e) (i) still air conditions in the case of the most suitable runway for a landing in still air conditions;
- (ii) not more than 50 per cent of the forecast wind component opposite to the direction of landing or not less than 150 per cent of the forecast wind component in the direction of landing in the case of the runway that may be required for landing because of the forecast wind conditions.

SCHEDULE 16

Article 44

THE AIR NAVIGATION (DANGEROUS GOODS) REGULATIONS

Citation

1. These Regulations may be cited as the Air Navigation (Dangerous Goods) Regulations.

Interpretation

2

- (1) In these Regulations:—

“consignment” means one or more packages of dangerous goods accepted by an operator from one shipper at one time and at one address receipted for in one lot and moving to one consignee at one destination address;

“dangerous goods” means any article or substance which is capable of posing significant risk to health, safety or property when carried by air and which is classified in Part 2 of the Technical Instructions;

“dangerous goods transport document” means a document, not being an air waybill, which is required by Regulation 4 of these Regulations to accompany a consignment of dangerous goods;

“package” means the packaging and the articles and substances contained therein including one or more packages which have been consolidated by one shipper into one container or enclosure for convenience in handling;

“packing” means the art and operation whereby articles and substances are wrapped up, enclosed in containers or otherwise secured, and “packed” shall be construed accordingly;

“Technical Instructions” means the 1995–96 English language edition of the Technical Instructions for the Safe Transport of Dangerous Goods by Air approved and published by decision of the Council of the International Civil Aviation Organisation;

“unit load device” means any type of freight container including any container designed for loading on an aircraft.

- (2) For the avoidance of doubt, any instructions or limitations contained in the Technical Instructions for the carriage of dangerous goods on passenger or cargo aircraft, as therein defined, shall for the purpose of these Regulations be interpreted as applying also to the carriage of such goods beneath passenger or cargo aircraft respectively.

Carriage of dangerous goods

3.—(1) An aircraft shall not carry or have loaded therein or suspended thereunder any dangerous goods, unless such goods are carried, loaded or suspended;

- (a) with the written permission of the Governor and in accordance with any conditions to which such permission may be subject; and
- (b) in accordance with the Technical Instructions and any conditions specified therein.

(2) A person shall not:

- (a) take or cause to be taken on board,
- (b) suspend or cause to be suspended beneath, or
- (c) delivery or cause to be delivered for loading on or suspension beneath

an aircraft any goods which he knows or ought to know or suspect to be goods capable of posing significant risk to health, safety or property when carried by air, unless the provisions of these Regulations are complied with.

(3) These Regulations shall not apply to dangerous goods of a type specified in Chapter 1.1.2(a), 1.1.2(b) and 2.3 of Part 1 and Chapter 1.2 of Part 9 of the Technical Instructions which are carried, loaded or suspended in accordance with the provisions of the aforesaid Chapters 1.1.2(a), 1.1.2(b) and 2.3 of Part 1 and Chapter 1.2 of Part 9 and which are:

- (a) articles and equipment which are required to be carried on an aircraft by or under the Order or are otherwise intended for use on an aircraft for the purpose of the good order of the flight in accordance with normal practice whether or not, in either case, such articles and equipment are required to be carried or intended to be used on that particular flight;
- (b) solely intended for the use of passengers or crew members or for sale to the passengers or crew members of the aircraft during the flight in question;
- (c) to provide during the flight veterinary aid or a humane killer for an animal; or
- (d) to provide during the flight medical aid to a person:

Provided that goods specified in sub-paragraphs (c) and (d) shall only be carried if:

- (i) they are or may be required for use during the flight;
- (ii) they are or may be required for use during a subsequent flight by the same aircraft and it will not be practicable to load the goods on the aircraft in the intervening period before the commencement of that subsequent flight, or
- (iii) they were used or might have been required for use during a previous flight by the same aircraft and it has not been practicable to unload them from the aircraft since that flight.

(4) Save for Regulations 3(1)(a), 7(1) but only to the extent that it refers to the provisions in Chapter 2.1 of Part 5 of the Technical Instructions and 7(2) and 8(3) of these Regulations, these Regulations shall not apply to dangerous goods of the classifications specified in Chapter 2.5 of Part 1 of the Technical Instructions provided that:

- (a) the dangerous goods do not exceed the appropriate quantity limitations specified therein; and
- (b) such other conditions as are specified therein are complied with.

4.—(1) An aircraft shall not carry dangerous goods as cargo unless the shipper of the goods has furnished the operator of the aircraft with a dangerous goods transport document, except that such a document shall not be required in respect of such categories of dangerous goods as may be specified in the Technical Instructions as being goods in respect of which a dangerous goods transport document is not required.

Status: This is the original version (as it was originally made). This item of legislation is currently only available in its original format.

(2) The dangerous goods transport document shall be completed in duplicate by the shipper and shall:

- (a) describe the dangerous goods in accordance with and contain such information as is required by the provisions of Chapter 4.1 of Part 4 of the Technical Instructions;
- (b) contain a signed declaration that the Technical Instructions have been complied with in that the dangerous goods—
 - (i) are fully and accurately described, and
 - (ii) are correctly classified, packed, marked and labelled, and
 - (iii) are in a proper condition for carriage by air.

(3) The shipper of dangerous goods shall furnish the operator of the aircraft with such other documents in respect of dangerous goods as are required by Part 3 and Chapters 4.3 and 4.5 of Part 4 of the Technical Instructions.

(4) The operator of an aircraft shall preserve for not less than six months any dangerous goods transport document or other document in respect of dangerous goods which has been furnished to him in accordance with this Regulation.

Shipper's responsibilities

5. Before consigning any package containing dangerous goods for carriage by air the shipper shall ensure that:

- (a) the goods are not of a category whose carriage by air is prohibited by the provisions of Chapters 2.1 and 2.2 of Part 1 of the Technical Instructions;
- (b) the goods are classified and packed in accordance with Chapter 2.6 of Part 1 and Parts 2, 3 and 8 of the Technical Instructions and the packagings used are in accordance with such provisions of Part 7 of the Technical Instructions as apply to the goods;
- (c) the package is marked and labelled in accordance with such provisions of Chapter 11 of Part 2 and Part 3 as relate to marking and labelling and in accordance with Chapters 2 and 3 of Part 4 of the Technical Instructions;
- (d) the package is in a fit condition for carriage by air;
- (e) the dangerous goods transport document required by Regulation 4 of these Regulations has been completed and that the declaration therein has been signed by him or on his behalf.

Operator's responsibilities

6.—(1) The operator of an aircraft in which any package or unit load device containing dangerous goods is to be carried shall satisfy himself by making an inspection:

- (a) that the package is marked and labelled in accordance with the provisions of these Regulations, such provisions of Chapter 11 of Part 2 and Part 3 as relate to marking and labelling and Chapters 2 and 3 of Part 4 of the Technical Instructions before accepting the package;
- (b) that the package is not leaking or damaged so that the contents may escape—
 - (i) before accepting the package;
 - (ii) before loading or causing the package to be loaded on board the aircraft or before suspending or causing the package to be suspended beneath the aircraft, as the case may be;
 - (iii) upon loading the package from or from beneath the aircraft;

Status: This is the original version (as it was originally made). This item of legislation is currently only available in its original format.

- (c) that the unit load device is free from any evidence of leakage from or damage to any dangerous goods contained therein before loading or causing the unit load device to be loaded on board the aircraft or before suspending or causing the unit load device to be suspended beneath the aircraft, as the case may be.
 - (a) (2) (a) For the purpose of each of the inspections required by paragraph (1)(a) and (1)(b)(i) of this Regulation, an acceptance check list shall be used and the results of that inspection shall be recorded in accordance with the form thereof.
 - (b) The acceptance check list shall be in such form and shall provide for the entry of such details as will enable the relevant inspection to be fully and accurately made by reference to and completion of that list.
 - (c) The operator of an aircraft shall preserve for not less than six months a record of any acceptance check list completed in accordance with this Regulation. The record shall be in a legible or a non-legible form so long as the recording is capable of being reproduced in legible form.
- (3) The operator shall not load or cause to be loaded on an aircraft or suspend or cause to be suspended beneath an aircraft any package or unit load device containing dangerous goods which on inspection is found to be leaking or damaged so that the contents or the dangerous goods therein may escape or be damaged.
- (4) The operator shall unload or cause to be unloaded any package containing dangerous goods which appears to be leaking or damaged on board or beneath an aircraft and shall ensure other cargo or baggage loaded or suspended beneath that aircraft is in a fit state for carriage by air and has not been contaminated.
- (5) The operator shall after unloading inspect for signs of damage or contamination in any part of the aircraft, or any sling or other apparatus which has been used to suspend goods beneath the aircraft, in which:
- (a) a unit load device containing dangerous goods was stowed, or
 - (b) any damaged or leaking package containing dangerous goods was loaded,
- and the operator shall remove or repair any contamination or damage.
- (6) The operator of an aircraft shall not permit it to fly for the purpose of carrying passengers or cargo if he knows or suspects radioactive materials to have leaked in or contaminated the aircraft or any sling or other apparatus attached to the aircraft unless the radiation level resulting from the fixed contamination at any accessible surface and the non-fixed contamination are not more than the values specified in Chapter 3.2 of Part 5 of the Technical Instructions.

Method of loading by operator

7.—(1) The operator shall ensure that any package containing dangerous goods is loaded, stowed and unloaded from or from beneath an aircraft in accordance with the provisions in Chapter 2 of Part 5 of the Technical Instructions which apply to that category of dangerous goods.

(2) An aircraft shall not carry any dangerous goods either in any compartment occupied by passengers or in the flight crew compartment, except in circumstances permitted by the provisions of Chapter 2.1 of Part 5 of the Technical Instructions.

Provisions of information and training programmes by operators and shippers

8.—(1) The operator of an aircraft in which dangerous goods are to be carried shall, before the flight begins, provide the commander of the aircraft with written information specifying the matters required by the provisions of Chapter 4.1 of Part 5 of the Technical Instructions and shall preserve a copy thereof for not less than six months.

Status: This is the original version (as it was originally made). This item of legislation is currently only available in its original format.

(2) The operator of an aircraft in which passengers are to be carried or his agent shall notify them of the categories of dangerous goods which may not be taken on board an aircraft either as checked baggage or accompanying a passenger by the provision of information with each passenger ticket which shall be sufficient in prominence for this purpose and by displaying notices, sufficient in number and prominence for this purpose, at each of the places at an airport where the operator or his agent issues tickets, checks in baggage or maintains areas to assemble passengers to board the aircraft.

(3) The operator of an aircraft and a shipper of dangerous goods by air and, in each case, any agent thereof shall inform any of their respective employees whose duties include a function connected with the carriage of passengers or cargo by air of the provisions of the Technical Instructions and for this purpose shall establish and undertake training programmes, as required by Chapter 1 of Part 6 of the Technical Instructions, which shall be submitted to the Governor for approval on such occasions as the Governor may require and which shall be amended as the Governor may require.

Production of documents and records

9. The operator of an aircraft shall, within a reasonable time after being requested so to do by an authorised person, cause to be produced to that person such of the following documents as may have been requested by that person:

- (a) the written permission referred to in Regulation 3(1) of these Regulations;
- (b) the dangerous goods transport document or other document in respect of any dangerous goods referred to in Regulation 4 of these Regulations;
- (c) the completed acceptance check list in a legible form in respect of any dangerous goods, referred to in Regulation 6(2) of these Regulations;
- (d) a copy of the written information provided to the commander of the aircraft in respect of any dangerous goods, referred to in Regulation 8(1) of these Regulations.

Dropping articles for agricultural, horticultural, forestry or pollution control purposes

10. Subject to the provisions of Regulation 3(1)(a) of these Regulations, nothing in these Regulations shall apply to any aircraft flying in order to drop articles for the purpose of agriculture, horticulture, forestry or pollution control.

The following Table shows, in relation to each Article of this Order, the corresponding Article in the Air Navigation (Overseas Territories) Order 1977, as amended.

TABLE OF COMPARISON

This Order	1977 Order, as amended
1	1
2	2
3	3
4	4
5	5
6	6
7	7
8	8 (as amended in 1978)

Status: This is the original version (as it was originally made). This item of legislation is currently only available in its original format.

This Order	1977 Order, as amended
9	9
10	—
—	10
11	11 (as amended in 1978)
12	12
13	13
14	14
15	15 (as amended in 1978)
16	16
17	17
18	18 (as amended in 1978)
19	19 (as amended in 1978)
20	20 (as amended in 1978)
21	21
22	22
23	23 (as amended in 1978)
24	24
25	25 (as amended in 1978)
26	26
27	27
28	28 (as amended in 1978)
29	29 (as amended in 1978)
30	30
31	31
31A	—
32	32
33	33 (as amended in 1978)
33A	—
34	34
35	35
36	35A(as amended in 1978)
37	36 (as amended in 1978)
38	37
39	38 (as amended in 1978)

Status: This is the original version (as it was originally made). This item of legislation is currently only available in its original format.

This Order	1977 Order, as amended
40	39 (as amended in 1978)
41	—
42	39A(as amended in 1978)
43	40 (as amended in 1978)
44	41
45	42
46	43
47	44
48	45
49	46
50	47
51	48
52	49
53	50
54	51
55	52
56	53
57	54
58	55
59	56
60	—
61	57
62	58
63	59
64	60
64A	—
64B	—
65	61 (as amended in 1978)
66	62 (as amended in 1978)
67	62A(as amended in 1978)
68	63 (as amended in 1978)
69	64
70	65
71	66

Status: This is the original version (as it was originally made). This item of legislation is currently only available in its original format.

This Order	1977 Order, as amended
72	67
73	68
74	69
75	70
76	71
77	72
78	73
79	74
80	75
81	76
82	76A(as amended in 1978)
83	—
—	83
84	78
85	—
86	79
87	80
88	81
89	82
90	83
91	84 (as amended in 1977)
92	85
93	86
94	87
95	88
96	89
—	90
97	91
98	92
99	93 (as amended in 1978)
100	94
101	—

Status: This is the original version (as it was originally made). This item of legislation is currently only available in its original format.

EXPLANATORY NOTE

(This note is not part of the Order)

This Order supersedes the Air Navigation (Overseas Territories) Order 1977 (S.I. 1977/422), as amended (S.I. 1977/820, and S.I. 1978/1520), and is based closely on the Air Navigation (Overseas Territories) Order 1989 (S.I. 1989/2395), as amended.

The Table of Comparison specifies the corresponding Article numbers of the Air Navigation (Overseas Territories) Order 1977, as amended.

Apart from minor and drafting amendments, this order and its Schedules differ from the 1977 Order in the following respects (References to Articles in this Note are to this Order unless otherwise stated):

The Order

(1) Specific provision for gliders to fly unregistered is deleted and gliders being used for flying instruction do not need to have a certificate of airworthiness in force. (Articles 3(1) and 7(2)(a)).

(2) The Governor may now keep the register of aircraft in Hong Kong on computer provided that the particulars so recorded can be reproduced in a legible form (Article 4(1)). There is no longer any provision for temporary transfer to or from the Hong Kong register.

(3) A certificate of airworthiness now becomes invalid if an inspection required by the maintenance schedule approved by the Governor in respect of the aircraft has not been carried out. (Article 8(7)). In addition the Governor is not obliged to accept any application in respect of an airworthiness certificate without supporting reports (Article 8(8)).

(4) Certificates of maintenance are replaced by certificates of maintenance review which must certify not only that an aircraft has been maintained in accordance with the maintenance schedule approved by the Governor in respect of the aircraft but also that the aircraft has been inspected and modified as required by the Governor, that defects entered in the technical log of the aircraft have been rectified or deferred in accordance with procedures approved by the Governor and that certificates of release to service have been issued in respect of the overhaul, repair, replacement, modification, maintenance or inspection of the aircraft. Every aircraft registered in Hong Kong which has a certificate of airworthiness in the transport or aerial work category, whether or not it is in fact flying for purposes of public transport or aerial work, is now prohibited from flying unless it has been maintained in accordance with a maintenance schedule approved by the Governor and it has a valid certificate of maintenance review. An aircraft is no longer permitted to fly solely for training purposes if the radio station has not been maintained in accordance with the approved maintenance schedule or if there is no certificate of maintenance review in force in respect of the radio station. (Article 9).

(5) A technical log must now be kept for any aircraft registered in Hong Kong which has a certificate of airworthiness in the public transport or aerial work category, whether or not it is in fact flying for the purpose of public transport or aerial work. The commander of the aircraft need not now include in the details recorded in the technical log particulars of any defect which does not affect the airworthiness or safe operation of the aircraft, but he must include any other particulars which the Governor may require in respect of the airworthiness or operation of the aircraft. In the case of an aircraft whose maximum total weight authorised does not exceed 2,730 kg and which is not operated by a person who holds or is required to hold an air operator's certificate, the details

may, instead of being entered in the technical log, be entered in some other record approved by the Governor. (Article 10).

(6) Certificates of compliance are replaced by certificates of release to service which must be issued not only when a part of an aircraft or its equipment has been inspected, overhauled, repaired, replaced or modified but also when the aircraft has been maintained. The dispensation of owners and operators of small aircraft doing prescribed repairs is now confined to aircraft in the private and special categories. (Article 11).

(7) The privileges attaching to an aircraft maintenance engineer's licence are no longer specified in the Order but are specified in the licence itself. The maximum period of validity of such a licence is extended to 5 years. For the avoidance of doubt it is expressly provided that the Governor may approve courses of training or instruction, persons to provide such courses, persons as qualified to furnish reports to him and the Governor may authorise persons to conduct examinations and tests specified by him in relation to the function of the Governor in licencing aircraft maintainance engineers. (Article 12.)

(8) Individual safety leaflets containing pictorial information and instructions are now required to be provided for each passenger on a public transport aircraft registered in Hong Kong unless the Governor has given written permission for a notice or notices to be exhibited in each passenger compartment. (Article 13(5)).

(9) Aeroplanes of 5,700 kg or less flying for the purpose of public transport under Instrument Flight Rules must carry two qualified pilots if they are multi-engined or powered by turbine jet or powered by one or more turbine propeller engines and pressurised. Unpressurised turbo prop aircraft which may only carry fewer than ten passengers and piston engined aircraft may carry only one pilot provided that the aircraft is fitted with an approved auto-pilot. (Article 18(3)).

(10) Cabin attendants must be carried by any aircraft flying for the purpose of public transport on which at least twenty passengers are actually carried or which is capable of carrying at least thirty five passengers and actually carries at least one passenger. The number of cabin attendants required varies with the number of passenger seats installed in the aircraft although a lesser number of attendants may be carried with the permission of the Governor. (Article 18(7)).

(11) The holder of a pilot's licence issued outside Hong Kong is no longer entitled either to act by virtue of the privileges of that licence as a pilot of an aircraft registered in Hong Kong and flying in Hong Kong's controlled airspace in circumstances requiring compliance with the Instrument Flight Rules or to give any instruction in flying. (Article 19(3)).

(12) Senior Commercial Pilot's licences are no longer issued.

(13) For the avoidance of doubt it is expressly provided that the Governor may approve courses of training or instruction, persons to provide such courses, and persons as qualified to furnish reports to him and the Governor may also authorise persons to conduct examinations and tests specified by him in relation to the functions of the Governor in licensing flight crews. (Article 20(11)).

(14) The holder of a personal flying log book is now required to record particulars of a flight at the end of a flight or as soon as practicable thereafter and the particulars to be recorded now include the date and places of embarkation on and disembarkation from an aircraft and the times during which he acted either as a member of the flight crew thereof or for the purpose of qualifying for the grant or renewal of a licence. For the purposes of the holder of a personal flying log book recording particulars therein and for the purposes of recording the flight times during which a person acted as a member of the flight crew of a helicopter, a helicopter is now deemed to be in flight from the moment it first moves under its own power for the purpose of taking off until the rotors are next stopped. (Articles 22 and 53(3)).

(15) The operator of an aircraft flying for the purpose of public transport must ensure that cabin baggage can be properly secured and if the aircraft is capable of seating more than 30 passengers the baggage carried in the cabin must not exceed the capacity of the stowage spaces approved by

Status: This is the original version (as it was originally made). This item of legislation is currently only available in its original format.

the Governor. The commander of an aircraft must take all reasonable steps to ensure that cabin baggage is properly secured and in the case of an aircraft flying for the purpose of public transport and capable of seating more than 30 passengers, that such baggage is stowed in approved stowage spaces unless carried in accordance with the specific written permission of the Governor. (Articles 28(6) and 34(2)(e)).

(16) Commanders of aircraft whether registered in Hong Kong or elsewhere are now required to confirm that they have the appropriate runway visual range at the time at which they descend below 1,000 feet above the height of the aerodrome at which they intend to land and to establish and maintain the appropriate visual reference once they are below the appropriate decision height or minimum descent height. Decision height is now defined in terms of a precision approach, which is itself now defined. Minimum descent height is defined in terms of a non-precision approach which is also now defined. A revised definition of runway visual range allows for it to be calculated by either human observation or instructions and from the touchdown zone or the midpoint of the runway. (Articles 30, 31 and 98(1)).

(17) The crew of helicopters flying over water in connection with the offshore exploitation or exploration of mineral resources in specified circumstances are required to wear a survival suit. (Article 33A and Schedule 5, paragraphs 4 and 5).

(18) Lifejacket demonstrations are required before take-off on all public transport flights which either fly beyond gliding distance from land and are required to carry a cabin attendant or are intended to fly beyond 30 minutes flying time from land. In addition, a lifejacket demonstration is required if, in the event of any emergency occurring during take-off or landing, it is reasonably possible that the aircraft would be forced to land onto water. The required demonstrations need not be practical and may comprise an audio-visual presentation in the aircraft or prior to boarding. Where the requirements to carry out such demonstrations arise, a lifejacket must be carried for each person on board the aircraft.

All passengers aged two years or more must have their own seat. All passengers aged less than two years must be provided with a child restraint device. In addition to taking all reasonable measures to ensure that all passengers are familiar with the position and method of use of emergency exits, safety belts, safety harnesses, oxygen equipment and lifejackets, the commander must take the same measures in respect of the floor path lighting system. (Article 34(2)).

New requirements are introduced for the carriage of oxygen aboard aircraft on public transport flights. The main features of the new requirements are that all pressurised aircraft operating above flight level 250 must carry a minimum of two hours' supply of oxygen for flight crew and ten minutes for each passenger cabin occupant. In addition, dedicated first aid oxygen is to be carried together with portable breathing equipment for cabin attendants. Except for changes to altitude bands, the requirements for pressurised aircraft operating below flight level 250 and for unpressurised aircraft are similar to the previous requirements. The new requirements apply only to new aircraft, as specified in the Order, although older aircraft may elect to comply with either the existing or the new requirements. The one change which affects all public transport aircraft is that all flight crew are required to use supplemental oxygen when flying above 10,000 feet for any period whatsoever. Aircraft commanders are also now required to take all reasonable steps to ensure that all passengers and baggage are properly secured in the event that the aircraft encounters turbulence or any emergency. (Article 34 and Schedules 5 and 6).

(19) A member of the flight crew of an aircraft may now be required to operate radio or radio navigation equipment with which the aircraft is required to be equipped by either the appropriate air traffic control unit or when flying in notified airspace. (Article 35(3)).

(20) Aircraft registered in Hong Kong are now required to be equipped with radio navigation equipment if flying in controlled airspace. Aircraft not registered in Hong Kong may only use such equipment if it conforms with the law of the state of registry. (Schedule 6).

(21) A helicopter on any flight will be required to be equipped with a 4-channel cockpit voice recorder to which is attached an under-water sonar location device if the certificate or airworthiness is issued in the transport category and the helicopter either has a maximum total weight authorised exceeding 2,730 kg or the capacity to carry more than nine passengers. (Schedule 5).

On flights by such helicopters the cockpit voice recorder is required always to be in use from the time the rotors first turn for the purpose of taking off until the rotors are next stopped. (Article 37(3)).

(22) The commander of an aircraft about to tow a glider is now additionally required to satisfy himself before the towing aircraft takes off that it is capable of reaching and maintaining a safe height at which to separate the towing aircraft and glider. (Article 38(3)).

(23) The launching and picking up of tow ropes, banners or similar articles is now prohibited except at an aerodrome. (Article 39(2)).

(24) A passenger may be carried in a helicopter which is carrying a suspended load provided that the passenger is a person who has been raised from the surface or who it is intended shall be lowered to the surface. (Article 39(6)).

(25) Parachuting from an aircraft flying over Hong Kong is now allowed with the written permission of the Governor. An aircraft may now only be used for such purposes if the certificate of airworthiness includes an express provision that the aircraft may be used for that purpose and in accordance with the provisions thereof. Every applicant for and holder of such a permission is required to make available to the Governor a parachuting manual if requested to do so and is required to make such amendment or addition to the manual as the Governor may require. (Article 41).

(26) An aircraft may now carry a munition of war with the written permission of the Governor if the operator of the aircraft has previously informed the commander in writing of the conditions of such permission and the details of the type, weight, quantity and location of the munition of war. A person may now have in his possession or cause to be taken on board an aircraft a weapon or munition of war if he has furnished the operator with particulars before the flight commences and the operator consents to the carriage of such weapon or munition of war which must be consigned as cargo or be part of a passenger's baggage and stowed in a place inaccessible to passengers and, in the case of a firearm, be unloaded. Foreign registered aircraft may if permitted by the law of the state in which they are registered carry weapons or munitions of war for the purpose of ensuring the safety of the aircraft or of persons on board. (Article 43).

(27) Schedule 16 to the Order contains regulations prescribing the classification of articles and substances as dangerous goods and the conditions which apply to the carriage of such goods by aircraft including the manner in which they must be packed, marked, labelled and consigned and loaded. The regulations also prescribe the documents which must be produced to the Governor or an authorised person and the persons to whom information about the carriage of dangerous goods must be provided. It shall be an offence to contravene or permit the contravention of the regulations. The Governor may supplement, amend or replace the regulations in Schedule 16. (Article 44).

(28) Every exit from a public transport aircraft (except helicopters) registered in Hong Kong must be marked as either an Exit or Emergency Exit in capital letters. (Article 46(3)).

(29) The Governor and authorised persons are given the power to inspect and copy specified documents. (Article 60).

(30) A person who has ceased to be the operator of an aircraft is no longer required to preserve certain documents relating to the aircraft or its engines if another person who has become the operator of the aircraft or the aircraft in which the engines are installed demands delivery of those documents even though the aircraft ceases to remain registered in Hong Kong. (Article 61).

Status: This is the original version (as it was originally made). This item of legislation is currently only available in its original format.

(31) Air Traffic Control services are now to be provided only with the permission of the Governor. For the avoidance of doubt it is expressly provided that the Governor may approve persons to conduct examinations and tests on applicants for and the holders of an air traffic controller's licence, a student air traffic controller's licence or an aerodrome flight information service officer's licence. (Articles 64A and 65).

The Governor may now require an applicant for or holder of air traffic controller's licence, a student air traffic controller's licence or an aerodrome flight information service officer's licence to subject himself to examinations and tests and to furnish evidence as to his knowledge, experience, competence and skill. (Article 65(7) and (8)).

(32) If the commander of an aircraft becomes aware that he is within restricted airspace he must, unless otherwise instructed, leave that airspace by the shortest route. In addition to complying with instructions or prescribed visual signals whilst within such restricted airspace he must now in addition comply with such instructions and signals when within a Danger Area which is now defined as being airspace which has been notified as such. (Articles 69 and 98).

(33) The launching by winch and cable or by ground tow of gliders or parascending parachutes to a height of more than 60 metres is prohibited except with the permission of the Governor and in accordance with any conditions imposed.

(34) Helicopters and gyroplanes engaged on flights for the purpose of the public transport of passengers which begin and end at the same aerodrome are no longer required to take off from and land at a Government aerodrome or a licensed aerodrome. In addition, the requirement that all aeroplanes flying for the purpose of instruction in flying shall take off or land at a licensed aerodrome or a Government aerodrome, is amended so that it now only applies to instruction in flying given for the purpose of becoming qualified for the grant of a pilot's licence, the inclusion of an aircraft rating or a night rating in a licence, or for the purpose of carrying out flying tests in respect of such a purpose. (Article 71).

(35) Contravention of an aerodrome licence or of a condition of such a licence is now an offence only if the contravention relates to an aircraft engaged on a flight for which it is required to take off or land from a licensed aerodrome. (Article 73(5)).

(36) The provisions of Articles 74 and 75 are no longer restricted to licensed aerodromes from which aircraft of which the maximum total weight authorised exceeds 2,730 kg operate on flights for the public transport of passengers.

The Governor is now required to approve the purpose of any aeronautical radio station before it is established or used and its equipment must be of a type of which the specification has been approved by the Governor for the purpose for which it is to be used.

The person in charge of an aeronautical radio station the purpose of which is to provide radio or radar navigational aid to aircraft making an approach to land at an aerodrome must now have all aeronautical radio stations operated by him at that aerodrome installed, modified, maintained and flight checked by the Governor or by a person approved by the Governor before he may provide such navigational aid. He must also notify the type and hours of operation of any service available for use by aircraft if the aeronautical radio station is at an aerodrome for which a licence for public use has been granted, or in the case of an aeronautical radio station at any other aerodrome, if he is required to do so by the Governor in approving the purposes for which the aeronautical radio station is to be used.

Instead of the aerodrome licensee the person in charge of an aeronautical radio station approved by the Governor is now required to keep written records and recording apparatus which must record specified particulars at all times when the aeronautical radio station is in operation for providing an air traffic control service. (Articles 74 and 75).

(37) New definitions of the expressions "aeronautical beacon" and "aeronautical ground light" replace the definition of "aeronautical light" (Article 98). The permission of the Governor is now

only required for establishing, maintaining or altering the character of an aeronautical beacon within Hong Kong or an aeronautical ground light which is at a licensed aerodrome or which forms part of the lighting system for use by aircraft taking off from or landing at such an aerodrome. (Article 79).

(38) Aircraft registered other than in Hong Kong and the United Kingdom are restricted from flying over Hong Kong for the purpose of any form of aerial work except with the permission of the Governor and in accordance with any conditions to which such permission may be subject. (Article 84).

(39) Certain requirements as to the purposes for which an aircraft is being used and as to compliance with the direction of a foreign country's aeronautical authorities are imposed on the operator or commander of aircraft flying over any foreign country as provided for in the Protocol relating to an amendment (article 3 bis) to the Convention on Civil Aviation of 7th December 1944 (the Chicago Convention) (Cmd. 8742) which was approved at Montreal on 10th May 1984 (Cmd. 9275). A person is liable for a contravention on summary conviction to a fine and on conviction on indictment to an unlimited fine or imprisonment for a term not exceeding two years or both. (Article 85 and Schedule 13).

(40) The criminal offences created by the Order are re-classified to make only the most serious offences triable on indictment, and the maximum penalties for contravention of the provisions of the Order are increased.

Public transport flights without an air operator's certificate and flights without a certificate of airworthiness are now subject to a maximum penalty of a fine on summary conviction or to an unlimited fine or to imprisonment for a term not exceeding two years or both on conviction on indictment. (Article 91 and Schedule 13).

(41) The aerodrome traffic zone of an aerodrome on land is now defined in relation to the mid point of the longest runway at the aerodrome. The size of the aerodrome traffic zone depends on the length of that runway, and the runway end clearance provided for that and the other runways at the aerodrome. (Article 98).

(42) Definitions of airspace according to ICAO classifications are now included. (Article 98).

(43) There is a new definition of "flight recording system" which comprises flight data recorders and cockpit voice recorders. (Article 98).

(44) Specified minimum weather conditions are now included. (Article 98(7)).

The Schedules

(45) The detailed requirements for the display of nationality and registration marks on aircraft are amended. (Schedule 1, Part B).

(46) The required contents of an Aerodrome Manual (to be accepted as adequate before a licence is issued under Article 73 are described (Schedule 4). The privileges attached to an aircraft maintenance engineer's licence have been removed from the Order and are now attached to the licence itself.

(47) All aircraft within Hong Kong when flying under Instrument Flight Rules in controlled airspace are required to be provided with secondary surveillance radar equipment unless the appropriate air traffic control unit otherwise permits in relation to a particular flight and provided the aircraft complies with any instructions given by the air traffic control unit in a particular case. (Schedule 6, paragraph 2(1)).

(48) All aircraft, other than gliders, are now required to be provided with secondary surveillance radar when flying above Flight Level 100, unless the appropriate air traffic control unit otherwise permits in relation to a particular flight and provided the aircraft complies with any instructions given by the air traffic control unit in a particular case. (Schedule 6, paragraph (2)).

Status: This is the original version (as it was originally made). This item of legislation is currently only available in its original format.

(49) Additional smoke protection equipment is required for the crew of aircraft flying for the purpose of public transport. Additional oxygen must be provided for all portable breathing equipment carried on board, such equipment must be carried for all required cabin attendants and additional equipment must be carried in certain circumstances. (Schedule 5, paragraphs 4 and 5).

(50) The areas specified in connection with the carriage of Flight Navigators have been revised. (Schedule 8).

(51) The holder of a Private Pilot's Licence (Aeroplanes) may not fly on a flight outside controlled airspace when the flight visibility is less than 1½ nautical miles or out of sight of the surface unless he holds an instrument meteorological conditions rating. (Schedule 9, part A).

(52) The holder of a Private Pilot's Licence (Aeroplanes) which includes an instrument meteorological conditions rating (aeroplanes) may not fly as pilot in command of an aeroplane when it is taking off or landing at any place if the flight visibility below cloud is less than one nautical mile (Schedule 9, Part B). A consequential amendment has been made to the privileges of a holder of a Commercial Pilot's Licence (Aeroplanes). (Schedule 9, Part A).

(53) The privileges of the Commercial and Airline Transport Pilot's Licences (Aeroplanes) and (Helicopters and Gyroplanes) are restricted so that after he has reached 60 the holder of a licence may only fly an aircraft which weights 20,000 kg or less if it is fitted with dual controls and he is accompanied by a second appropriately licensed pilot who has not yet attained the age of 60. After he has reached 65 the holder of a licence is not permitted to fly any aircraft flying for the purpose of public transport. (Schedule 9, Part A).

(54) The holder of a Commercial Pilot's Licence (Airships) is required to have a valid Certificate of Test or a valid Certificate of Experience before exercising the privileges of the licence. The period of validity of the Commercial Pilot's Licence (Airships) is extended from six months to ten years. (Schedule 9, Parts A and C).

(55) For the avoidance of doubt Case E of the Table in Part C of Schedule 9 has been amended to make it clear that a certificate of test or certificate of experience is appropriate for any flight within the privileges of a Private Pilot's Licence including aerial work consisting of the giving of instruction in flying or the conducting of flying tests in either case in an aeroplane owned, or operated under arrangements entered into, by a flying club. (Schedule 9, Part C).

(56) The privileges of the Private Pilot's Licence (Aeroplanes) no longer permit receipt of any remuneration whatsoever for services as a pilot. They do however include the conduct of aerial work flights which consist of flying training and testing, glider towing and parachute dropping where these activities are carried out under the auspices of a club.

In order to fly as pilot in command at night, with or without passengers, the holder of a Private Pilot's Licence (Aeroplanes), a Basic Commercial Pilot's Licence (Aeroplanes) or a Private Pilot's Licence (Helicopters and Gyroplanes) must have a Night Rating included in the licence and the holder of a Commercial Pilot's Licence (Aeroplanes) or a Commercial Pilot's Licence (Helicopters and Gyroplanes) requires to have an Instrument Rating included in the licence or to have had specified experience within the previous 13 months. (Schedule 9, Part A, paragraph 1 and Part B, paragraph 1).

(57) The operator of a public transport aircraft who is required to produce an operations manual in respect of that aircraft shall include therein information and instructions relating to the labelling and marking of dangerous goods, the manner in which they must be loaded in an aircraft and the responsibilities of members of the crew in respect of the carriage of dangerous goods. (Schedule 11, Part A).

(58) With the written permission of the Governor, a flight manual need not be carried as part of the certificate of airworthiness if an operations manual is carried which includes specified information extracted from the flight manual. (Schedule 12).

(59) Schedule 14, which sets out the Rules of the Air has been amended in the following major respects:

- (a) in Rule 1, the definition of anti-collision light is amended to require rotorcraft to carry a flashing red light and to permit other aircraft to carry either a flashing red or a flashing white light;
- (b) Rules 5 and 34 set out new regulations concerning the picking up and dropping of tow ropes, banners or similar articles at aerodromes;
- (c) in Rule 5 it is provided that when calculating the ability of an aircraft to alight clear of a congested area or an assembly in the open air of more than 1,000 persons, if the aircraft is towing a banner, the calculation must be done on the basis that the banner will not be jettisoned whilst over the congested area or within 3,000 feet of such an assembly;
- (d) Rule 9 is amended to require aircraft fitted with an anti-collision light to display such a light in flight by day, to require an aircraft to display specified lights at night whilst on the ground unless it is stationary in a specified part of an aerodrome, to require an aircraft to display an anti-collision light when stationary on the apron of an aerodrome with its engines running and to permit any flashing light to be switched off or reduced in intensity if it may adversely affect members of the flight crew or outside observers;
- (e) Rule 10 is amended to permit an aircraft to continue to fly by day when its anti-collision light has failed subject to a specified condition;
- (f) Rule 11 is amended to impose the requirements previously applying to aircraft having a maximum total weight authorised of more than 5,700 kg also on any other flying machine of a type first certified on or after 1st January 1991;
- (g) Rule 15 is amended to require an airship to display an anti-collision light while flying at night; collision avoidance rules applicable to all aerodromes are transferred from Rule 35 to Rule 17;
- (h) Rule 19 is amended so that it no longer applies to an aircraft flying within airspace notified for the purposes of Rule 21 and in accordance with instructions given by the appropriate air traffic control unit;
- (i) the requirement of Rule 30 that the commander of a flying machine shall observe visual signals from an aerodrome now applies when he is flying in the pattern of traffic at the aerodrome instead of when he is flying in the aerodrome traffic zone;
- (j) Rule 32(1) has been amended to cover any part of an aerodrome which is not a public right of way;
- (k) Rule 35(2) and (3) which requires the commander of an aircraft to obtain permission before flying, taking off or landing in the traffic zone of an aerodrome specified in the Rule and to maintain communications with the ground while flying in such a zone, will now only apply to aircraft in the air traffic zone of an aerodrome notified for the purposes of the Rule and, at notified Government aerodromes, only during such times as are notified; only Government aerodromes, aerodromes with an air traffic control unit or an aerodrome flight information unit and licensed aerodromes with a means of two-way radio communication may be notified; the commander is now required to obtain permission only if there is an air traffic control unit at the aerodrome, in other cases, he must obtain information from the aerodrome flight information unit or from the radio station to enable the flight to be conducted with safety;
- (l) Rule 36 has been extended to cover aids provided by satellite as well as those in Hong Kong;
- (m) Rule 46 is amended to adopt the signals required by the relevant standard laid down by the International Civil Aviation Organisation and to extend the application of visual signals to

Status: This is the original version (as it was originally made). This item of legislation is currently only available in its original format.

include Danger Areas; the reference to signals requiring an aircraft to land following an authorised penetration of a Restricted or Prohibited Area is deleted.

(60) Schedule 15 which sets out the Air Navigation (General) Regulations has been amended and a notional male passenger weight of 83 kg is introduced for helicopters based in Hong Kong involved in support of or in connection with the offshore exploitation of or exploration for mineral resources (including gas)(Regulation 1(2)). The maximum semi-width of the obstacle clearance area after take-off is reduced from 1,500 to 900 metres (Regulations 4(3)(b)(ii), 5(4)(b)(ii) and 8(i)(iii)(b)(ii) and Annex (4)(b)(ii)). Any twin-engined public transport aeroplane in performance Group A of more than 5,700 kg certificated to carry 20 or more passengers, shall at no time during a flight be more than 60 minutes flying time at its one engine inoperative cruise speed from the nearest suitable alternate aerodrome, unless it is flying in accordance with the terms of a written permission from the Governor and any twin engined public transport aircraft in performance Group A of less than 5,700 kg or certificated to carry less than 20 passengers shall at no time during a flight be more than 90 minutes flying time at its one engine inoperative cruise speed from the nearest suitable alternate aerodrome (Regulation 4(5)).

It is made clear that the proviso to Regulation 4(7)(a) Schedule 15 applies only to subparagraph (ii) of that Regulation so that the landing distance required must not exceed the distance available on the runway most suitable for landing in still air conditions at both the aerodrome of destination and any alternative aerodrome.

(61) Helicopters flying for the purpose of public transport must comply with the specified weight and performance requirements. (Schedule 15, Regulations 9 to 11). A helicopter designated as being in performance Group A (Restricted) if its weight is less than 5,700 kg and the number of passengers carried does not exceed 15 and a helicopter designated as being in performance Group A or A (Restricted) may comply with the requirements for a helicopter designated as being in performance Group B if its weight is less than 2,730 kg and the number of passengers carried does not exceed 9. (Article 29(7)).

(62) Schedule 15 has been further amended to remove the provisions relating to radio navigational equipment; instead, simplified requirements are contained in Schedule 5.