Changes to legislation: There are outstanding changes not yet made to Commission Delegated Regulation (EU) No 626/2011. Any changes that have already been made to the legislation appear in the content and are referenced with annotations. (See end of Document for details) [View outstanding changes](#)

Commission Delegated Regulation (EU) No 626/2011 of 4 May 2011
supplementing Directive 2010/30/EU of the European Parliament
and of the Council with regard to energy labelling of air conditioners

Changes to legislation: There are outstanding changes not yet made to Commission Delegated Regulation (EU) No 626/2011. Any changes that have already been made to the legislation appear in the content and are referenced with annotations. (See end of Document for details) [View outstanding changes](#)

ANNEX III U.K.

The label

1. LABEL OF AIR CONDITIONERS, EXCEPT SINGLE DUCT AND DOUBLE DUCT AIR CONDITIONERS U.K.
- 1.1. **Reversible air conditioners classified in energy efficiency classes A to G** U.K.

Changes to legislation: There are outstanding changes not yet made to Commission Delegated Regulation (EU) No 626/2011. Any changes that have already been made to the legislation appear in the content and are referenced with annotations. (See end of Document for details) View outstanding changes

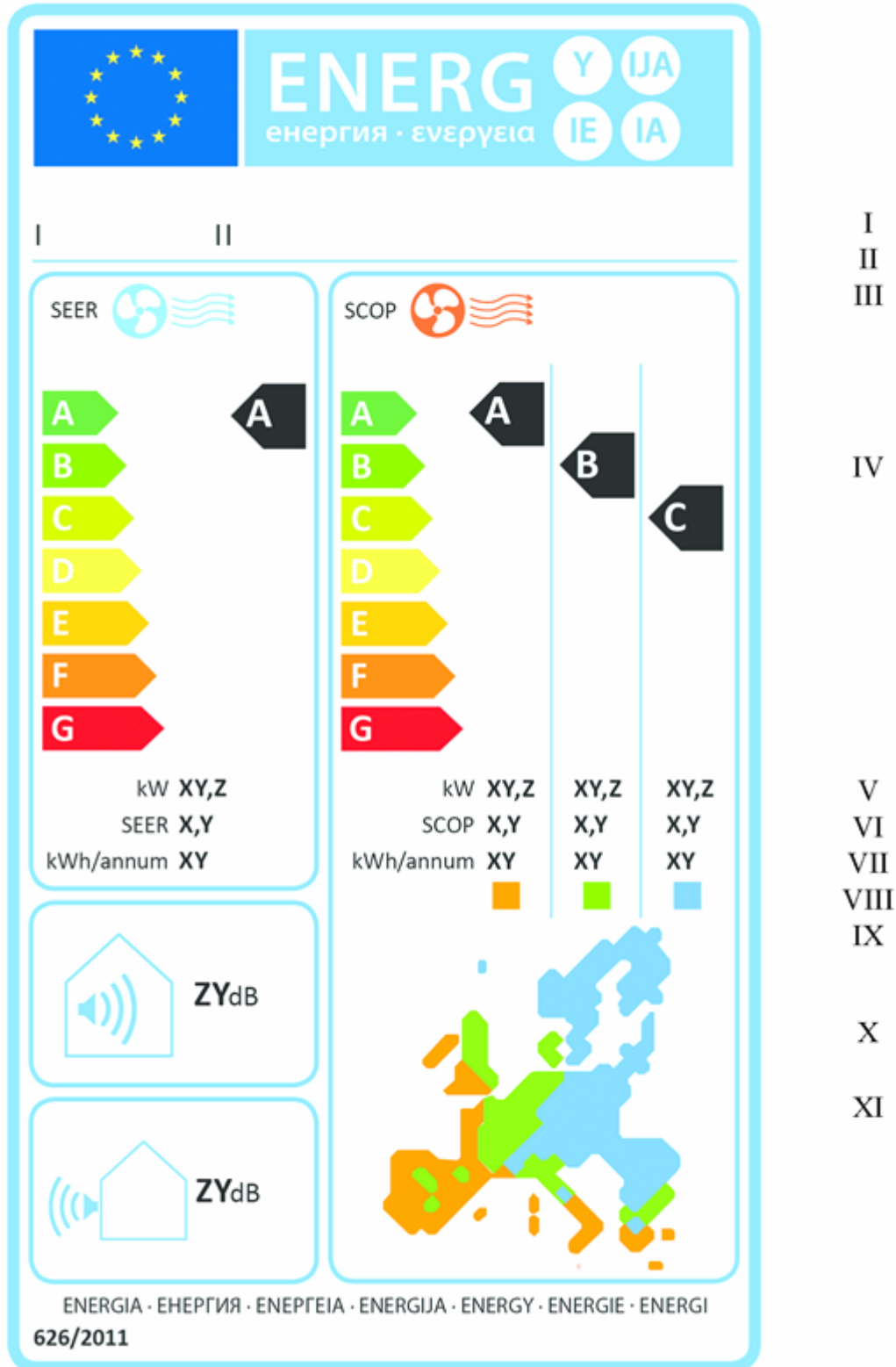

(a) The following information shall be included in the label: U.K.

Changes to legislation: There are outstanding changes not yet made to Commission Delegated Regulation (EU) No 626/2011. Any changes that have already been made to the legislation appear in the content and are referenced with annotations. (See end of Document for details) [View outstanding changes](#)

- I. supplier's name or trade mark;
- II. supplier's model identifier;
- III. text 'SEER' and 'SCOP' for cooling and heating, with a blue fan and air wave indication for SEER and red fan and air wave indication for SCOP;
- IV. the energy efficiency; the head of the arrow containing the energy efficiency class of the appliance shall be placed at the same height as the head of the arrow of the relevant energy efficiency class. Energy efficiency must be indicated for cooling and heating. For heating, energy efficiency for Average heating season is mandatory. Indication of efficiency for Warmer and Colder seasons is optional;
- V. for cooling mode: *design load* in kW, rounded up to one decimal;
- VI. for heating mode: *design load* in kW, for up to 3 heating seasons rounded up to one decimal. Values for heating seasons for which the *design load* is not provided shall be indicated as 'X';
- VII. for cooling mode: seasonal energy efficiency ratio (SEER value), rounded up to one decimal;
- VIII. for heating mode: seasonal coefficient of performance (SCOP value), for up to 3 heating seasons rounded up to one decimal. Values for heating seasons for which SCOP is not provided shall be indicated as 'X';
- IX. annual energy consumption in kWh per year, for cooling and heating, rounded up to the nearest integer. Values for climate profiles for which annual energy consumption is not provided shall be indicated as 'X';
- X. sound power levels for indoor and outdoor units expressed in dB(A) re1 pW, rounded to the nearest integer;
- XI. European map with a display of three indicative heating seasons and corresponding colour squares.

All the requested values shall be determined in accordance with Annex VII.

- (b) The design of the label shall be in accordance with point 1.5. By way of derogation, where a model has been granted an 'EU eco-label' under Regulation (EC) No 66/2010 of the European Parliament and of the Council⁽¹⁾, a copy of the EU eco-label may be added.

1.2. **Reversible air conditioners classified in energy efficiency classes A+ to F** U.K.

Changes to legislation: There are outstanding changes not yet made to Commission Delegated Regulation (EU) No 626/2011. Any changes that have already been made to the legislation appear in the content and are referenced with annotations. (See end of Document for details) View outstanding changes

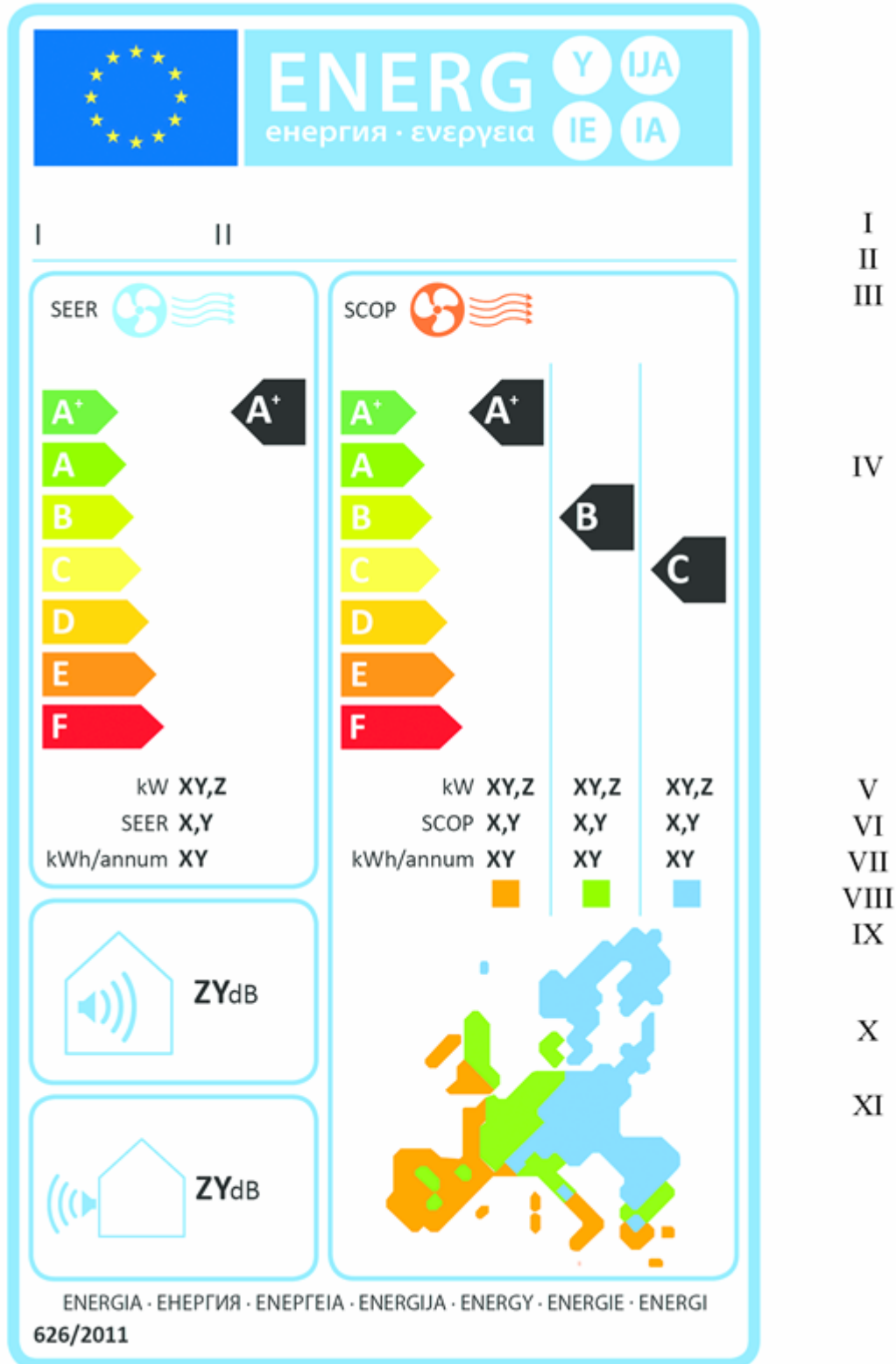

(a) The information listed in point 1.1 shall be included in the label.

Changes to legislation: There are outstanding changes not yet made to Commission Delegated Regulation (EU) No 626/2011. Any changes that have already been made to the legislation appear in the content and are referenced with annotations. (See end of Document for details) [View outstanding changes](#)

(b) The design aspects of the label shall be in accordance with point 1.5.

1.3. **Reversible air conditioners classified in energy efficiency classes A++ to E** 

Changes to legislation: There are outstanding changes not yet made to Commission Delegated Regulation (EU) No 626/2011. Any changes that have already been made to the legislation appear in the content and are referenced with annotations. (See end of Document for details) View outstanding changes

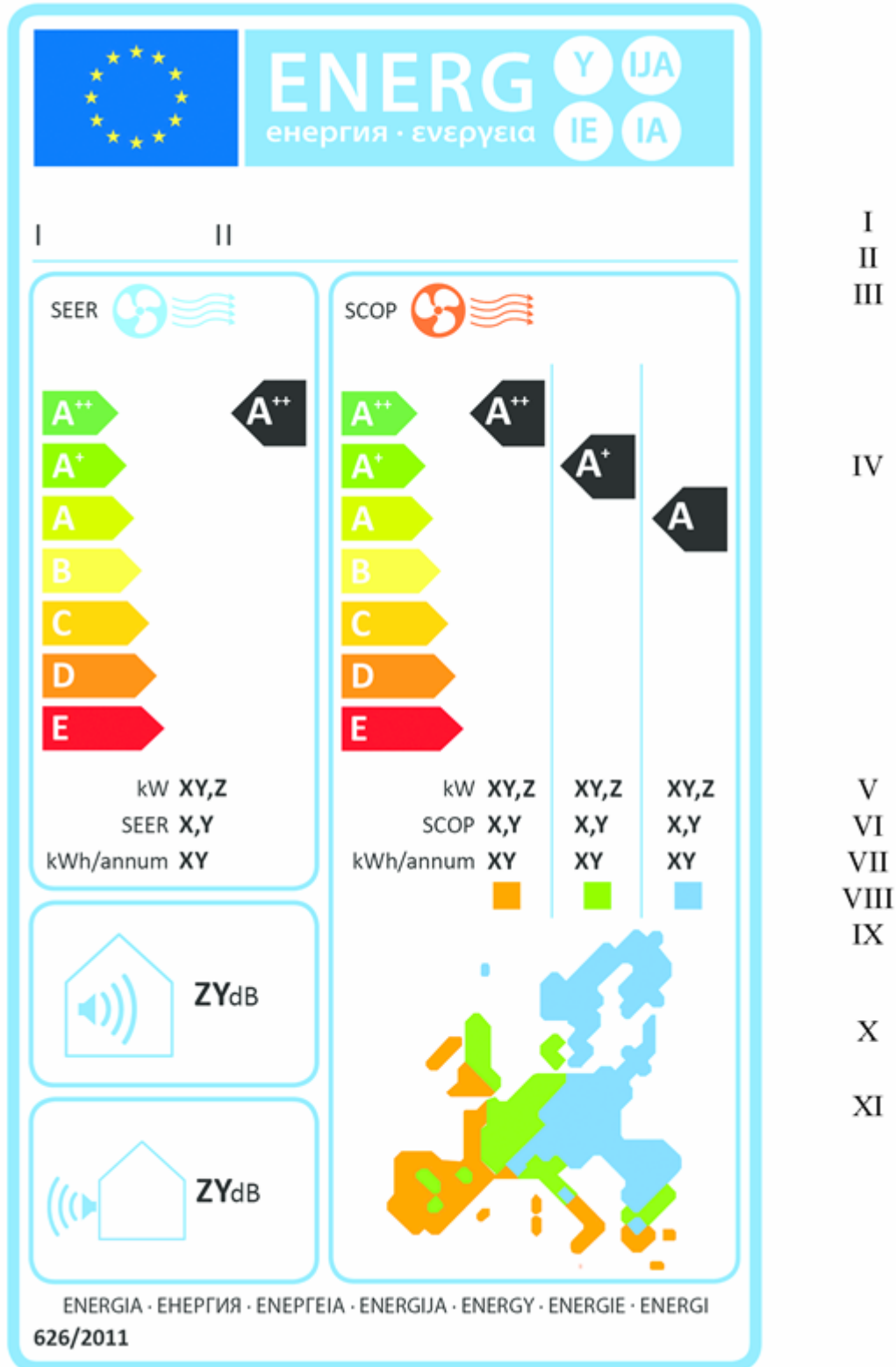

(a) The information listed in point 1.1 shall be included in the label.

Changes to legislation: There are outstanding changes not yet made to Commission Delegated Regulation (EU) No 626/2011. Any changes that have already been made to the legislation appear in the content and are referenced with annotations. (See end of Document for details) [View outstanding changes](#)

- (b) The design aspects of the label shall be in accordance with point 1.5.
- 1.4. **Reversible air conditioners classified in energy efficiency classes A+++ to D U.K.**

Changes to legislation: There are outstanding changes not yet made to Commission Delegated Regulation (EU) No 626/2011. Any changes that have already been made to the legislation appear in the content and are referenced with annotations. (See end of Document for details) View outstanding changes

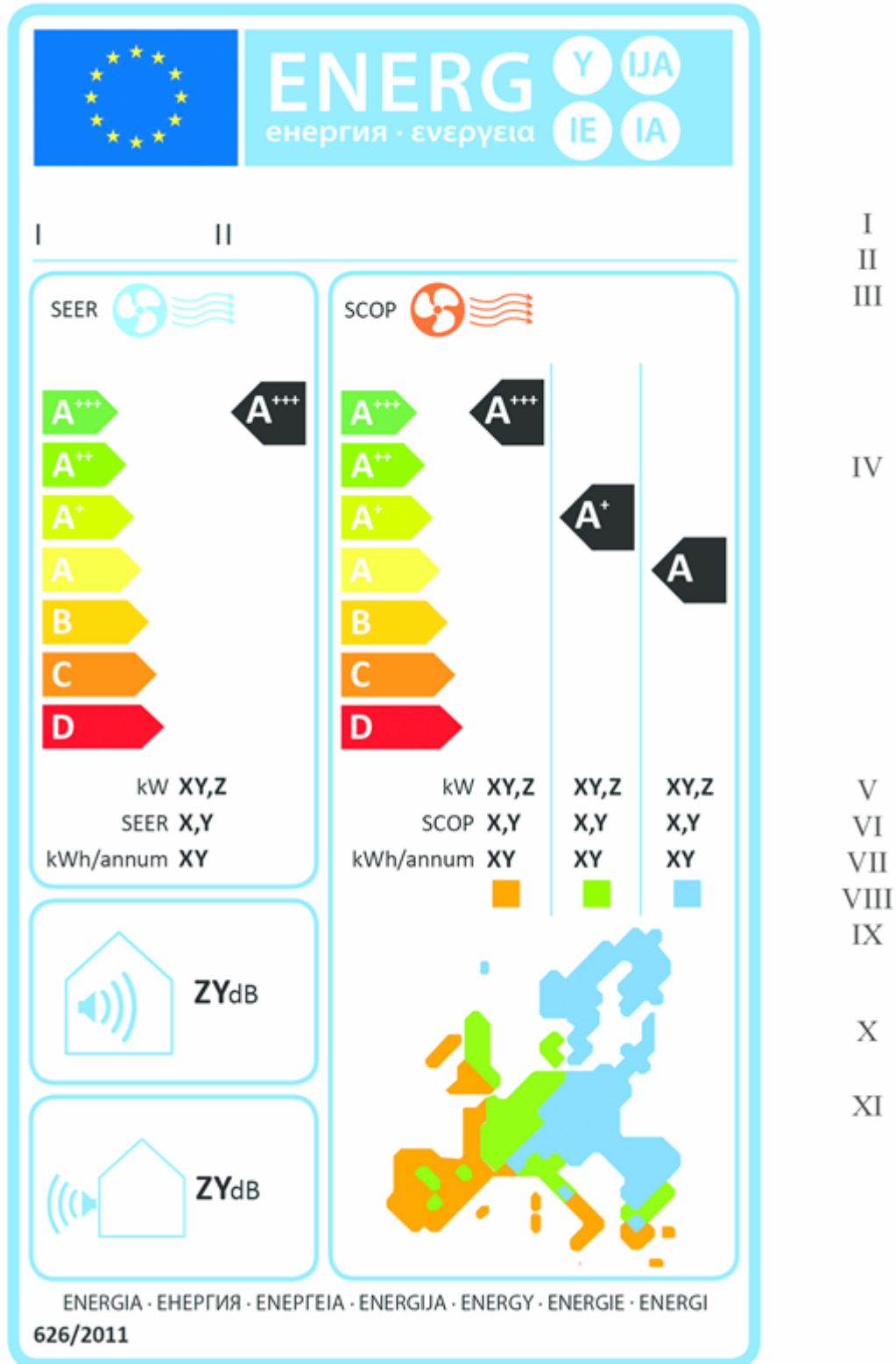

(a) The information listed in point 1.1 shall be included in the label.

Changes to legislation: There are outstanding changes not yet made to Commission Delegated Regulation (EU) No 626/2011. Any changes that have already been made to the legislation appear in the content and are referenced with annotations. (See end of Document for details) [View outstanding changes](#)

(b) The design aspects of the label shall be in accordance with point 1.5.

1.5. **Label design** **U.K.**

ANNEX III

Document Generated: 2023-09-17

Changes to legislation: There are outstanding changes not yet made to Commission Delegated Regulation (EU) No 626/2011. Any changes that have already been made to the legislation appear in the content and are referenced with annotations. (See end of Document for details) View outstanding changes

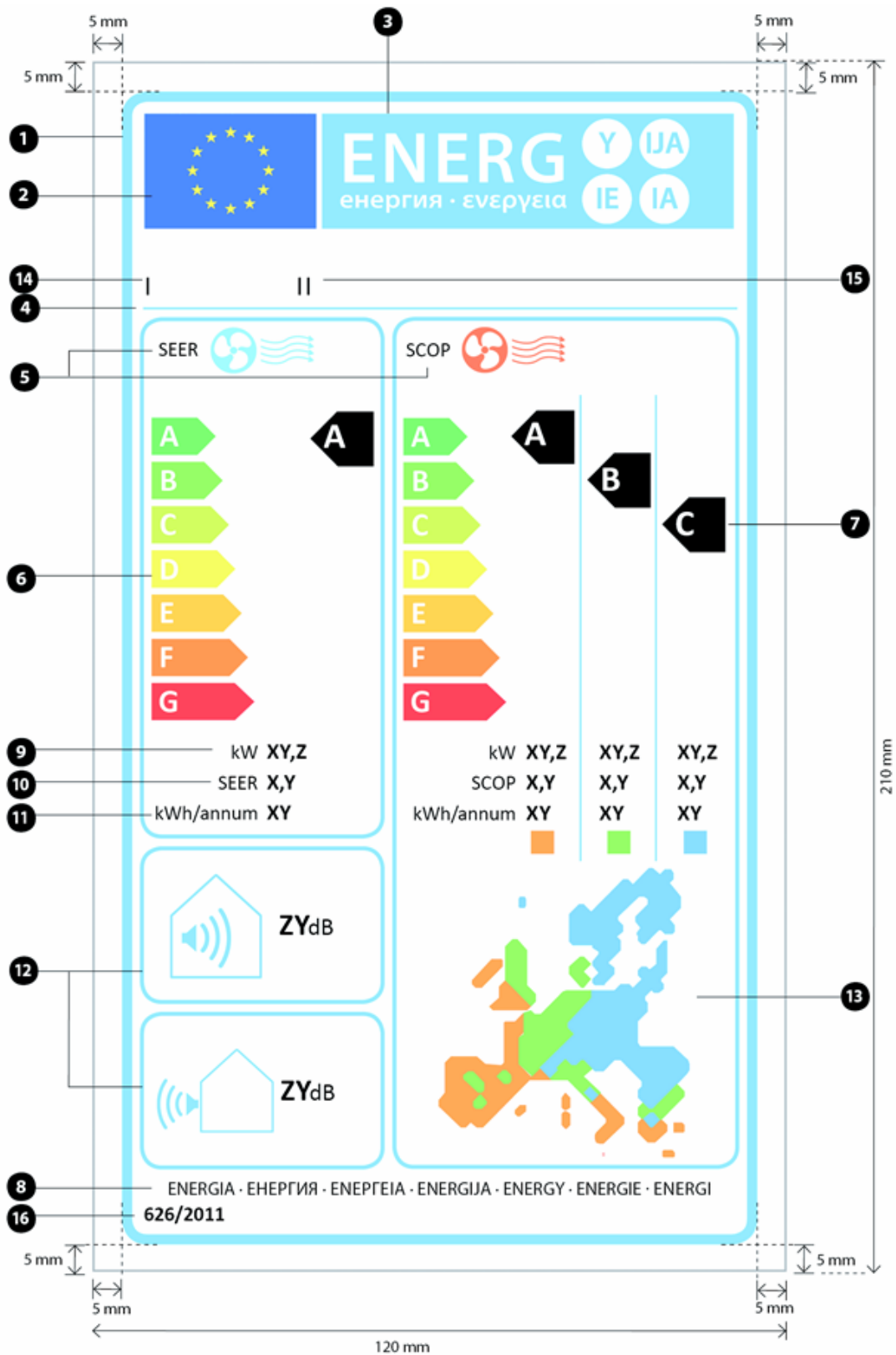

Whereby:

Changes to legislation: There are outstanding changes not yet made to Commission Delegated Regulation (EU) No 626/2011. Any changes that have already been made to the legislation appear in the content and are referenced with annotations. (See end of Document for details) View outstanding changes

- (i) The label shall be at least 120 mm wide and 210 mm high. Where the label is printed in a larger format, its content shall nevertheless remain proportionate to the specifications above.
- (ii) The background shall be white.
- (iii) Colours are coded as CMYK — cyan, magenta, yellow and black, following this example: 00-70-X-00: 0 % cyan, 70 % magenta, 100 % yellow, 0 % black.
- (iv) The label shall fulfil all of the following requirements (numbers refer to the figure above):
 - 1 **EU label border:** stroke 5 pt – colour: cyan 100 % – round corners: 3,5 mm.
 - 2 **EU logo:** Colours: X-80-00-00 and 00-00-X-00.
 - 3 **Energy label:** Colour: X-00-00-00.
Pictogram as depicted: EU logo + energy label:
width: 102 mm, height: 20 mm.
 - 4 **Sub-logos border:** 1 pt – colour: cyan 100 % – length: 103,6 mm.
 - 5 **SEER and SCOP indication:**
Border: 2 pt – colour: cyan 100 % – round corners: 3,5 mm.
Text: Calibri regular 10 pt, capitals, 100 % black.
 - 6 **A-G scale:**
 - **Arrow:** height: 7 mm, gap: 1 mm – colours:
Highest class: X-00-X-00
Second class: 70-00-X-00,
Third class: 30-00-X-00,
Fourth class: 00-00-X-00,
Fifth class: 00-30-X-00,
Sixth class: 00-70-X-00,
Last class(es): 00-X-X-00.
 - **Text:** Calibri bold 16 pt, capitals, white.
 - 7 **Energy efficiency class(es):**
 - **Arrow:** width: 11 mm, height: 10 mm, 100 % black;
 - **Text:** Calibri bold 18 pt, capitals, white.
 - 8 **Energy**
 - **Text:** Calibri regular 9 pt, capitals, 100 % black.
 - 9 **Rated capacity for cooling and heating in kW:**
 - **Text ‘kW’:** Calibri regular 10 pt, 100 % black.
 - **Value ‘XY,Z’:** Calibri bold 11 pt, 100 % black.
 - 10 **SCOP and SEER values, rounded up to one decimal:**
 - **Text ‘SEER’/‘SCOP’:** Calibri regular 10 pt, capitals, 100 % black.
 - **Value ‘X,Y’:** Calibri bold 11 pt, 100 % black.
 - 11 **Annual energy consumption in kWh/annum:**

Changes to legislation: There are outstanding changes not yet made to Commission Delegated Regulation (EU) No 626/2011. Any changes that have already been made to the legislation appear in the content and are referenced with annotations. (See end of Document for details) View outstanding changes

- **Text ‘kWh/annum’:** Calibri regular 10 pt, 100 % black.
- **Value ‘XY’:** Calibri bold 11 pt, 100 % black.

12 **Noise emissions:**

- **Border:** 2 pt – colour: cyan 100 % – round corners: 3,5 mm.

— Value:	Calibri bold 15 pt, 100 % black;
	Calibri regular 12 pt, 100 % black.

13 **European map and colour squares:**

- **Colours:**
 - Orange: 00-46-46-00.
 - Green: 59-00-47-00.
 - Blue: 54-08-00-00.

14 **Supplier’s name or trademark.**

15 **Supplier’s model identifier:**

The suppliers’ name or trade mark and model identifier should fit in a space of 102 × 13 mm.

16 **Reference period:**

- **Text:** Calibri bold 10 pt.

2. LABEL OF AIR CONDITIONERS, EXCEPT SINGLE DUCT AND DOUBLE DUCT AIR CONDITIONERS **U.K.**

2.1. **Cooling-only air conditioners classified in energy efficiency classes A to G** **U.K.**

Changes to legislation: There are outstanding changes not yet made to Commission Delegated Regulation (EU) No 626/2011. Any changes that have already been made to the legislation appear in the content and are referenced with annotations. (See end of Document for details) View outstanding changes

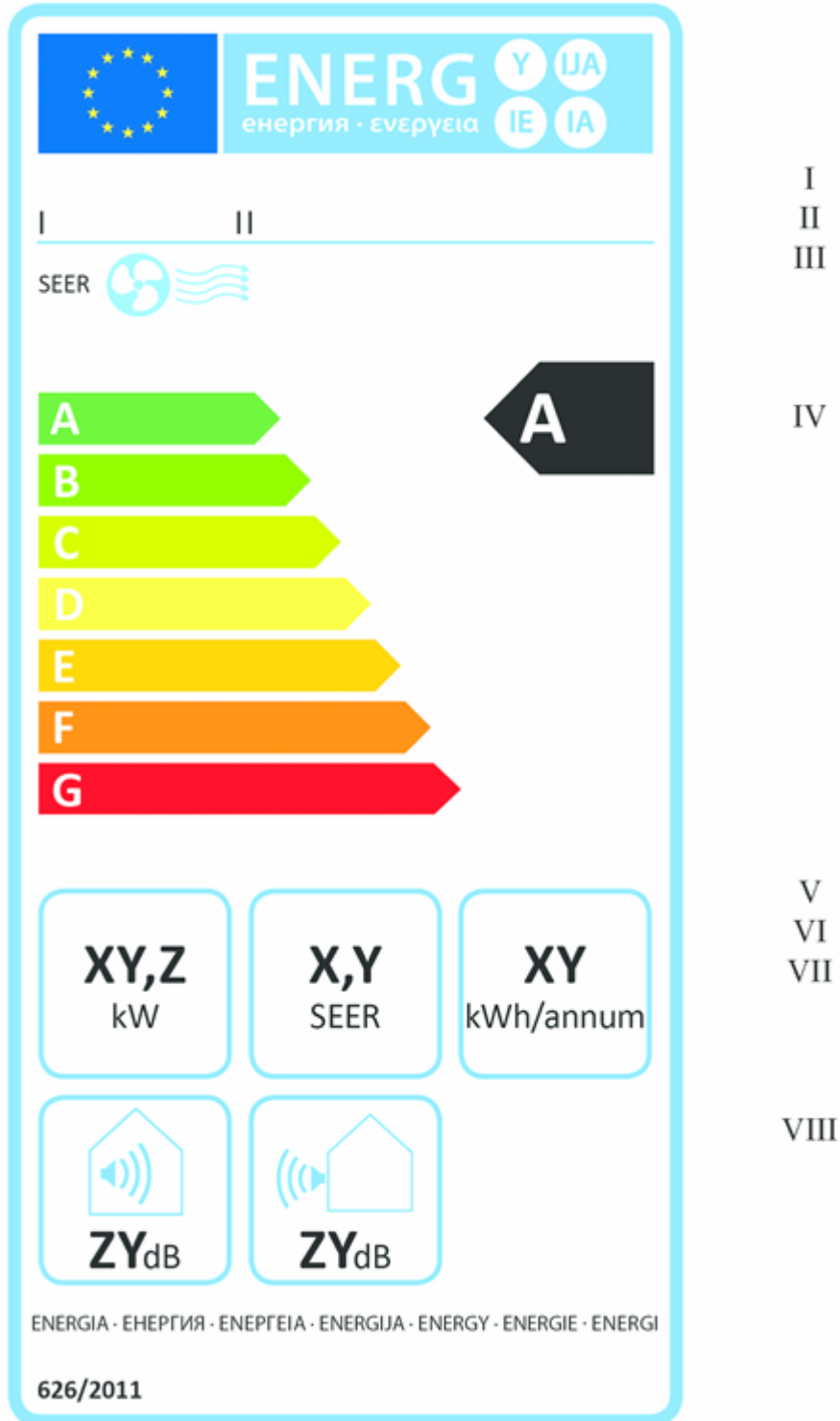

- (a) The following information shall be included in the label: **U.K.**
- I. supplier's name or trade mark;

Changes to legislation: There are outstanding changes not yet made to Commission Delegated Regulation (EU) No 626/2011. Any changes that have already been made to the legislation appear in the content and are referenced with annotations. (See end of Document for details) [View outstanding changes](#)

- II. supplier's model identifier;
- III. text 'SEER', with a blue fan and air wave indication;
- IV. the energy efficiency; the head of the arrow containing the energy efficiency class of the appliance shall be placed at the same height as the head of the arrow of the relevant energy efficiency class;
- V. design load for cooling in kW, rounded up to one decimal;
- VI. seasonal energy efficiency ratio (SEER value), rounded up to one decimal;
- VII. annual energy consumption in kWh per year, rounded up to the nearest integer;
- VIII. sound power levels for indoor and outdoor units expressed in dB(A) re1 pW, rounded to the nearest integer.

All the requested values shall be determined in accordance with Annex VII.

- (b) The design of the label shall be in accordance with point 2.5. By way of derogation, where a model has been granted an 'EU eco-label' under Regulation (EC) No 66/2010, a copy of the EU eco-label may be added.

2.2. **Cooling-only air conditioners classified in energy efficiency classes A+ to F** **U.K.**

Changes to legislation: There are outstanding changes not yet made to Commission Delegated Regulation (EU) No 626/2011. Any changes that have already been made to the legislation appear in the content and are referenced with annotations. (See end of Document for details) View outstanding changes

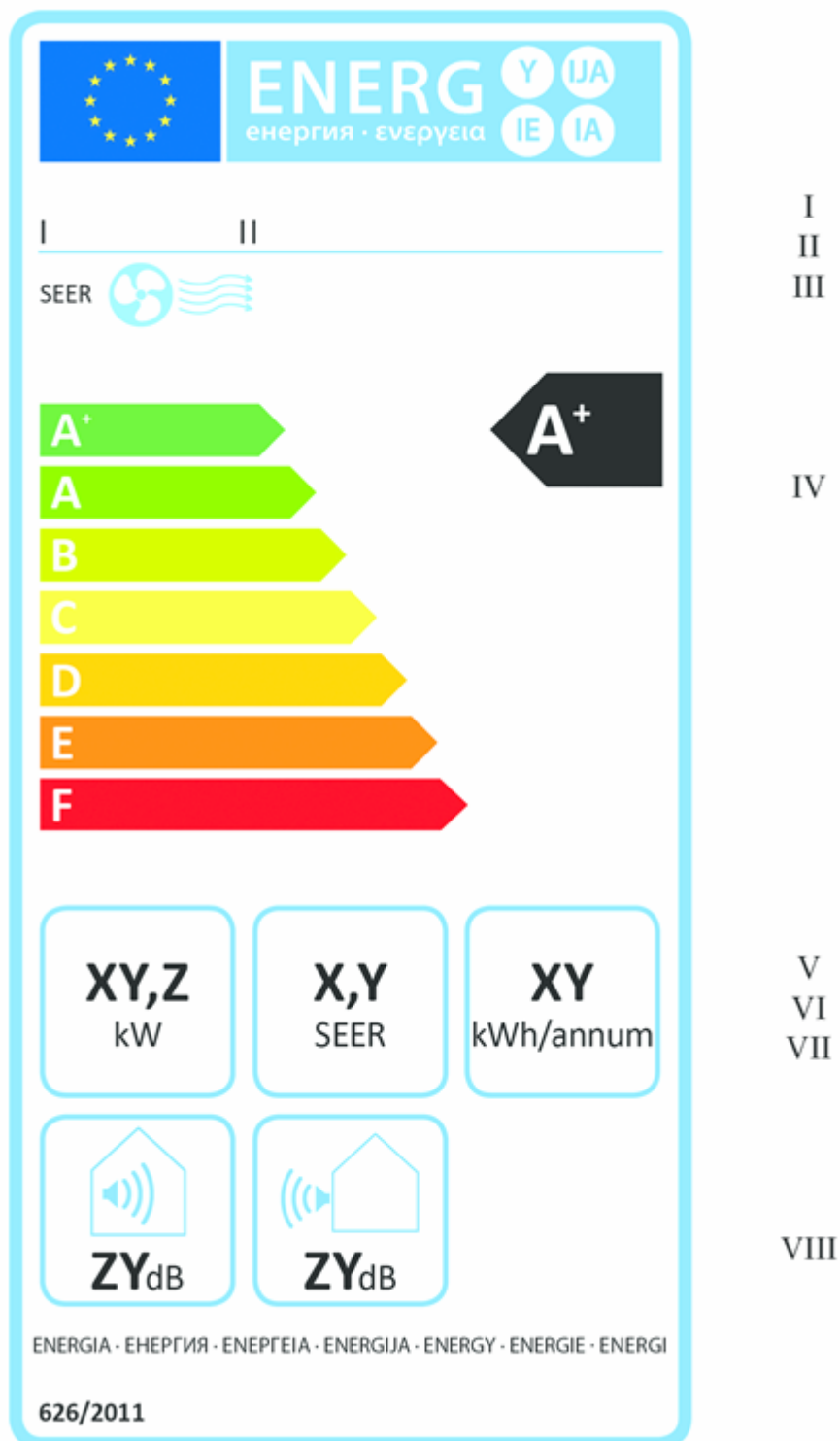

- (a) The information listed in point 2.1 shall be included in the label.
- (b) The design aspects of the label shall be in accordance with point 2.5.

Changes to legislation: There are outstanding changes not yet made to Commission Delegated Regulation (EU) No 626/2011. Any changes that have already been made to the legislation appear in the content and are referenced with annotations. (See end of Document for details) View outstanding changes

2.3. Cooling-only air conditioners classified in energy efficiency classes A++ to E **U.K.**

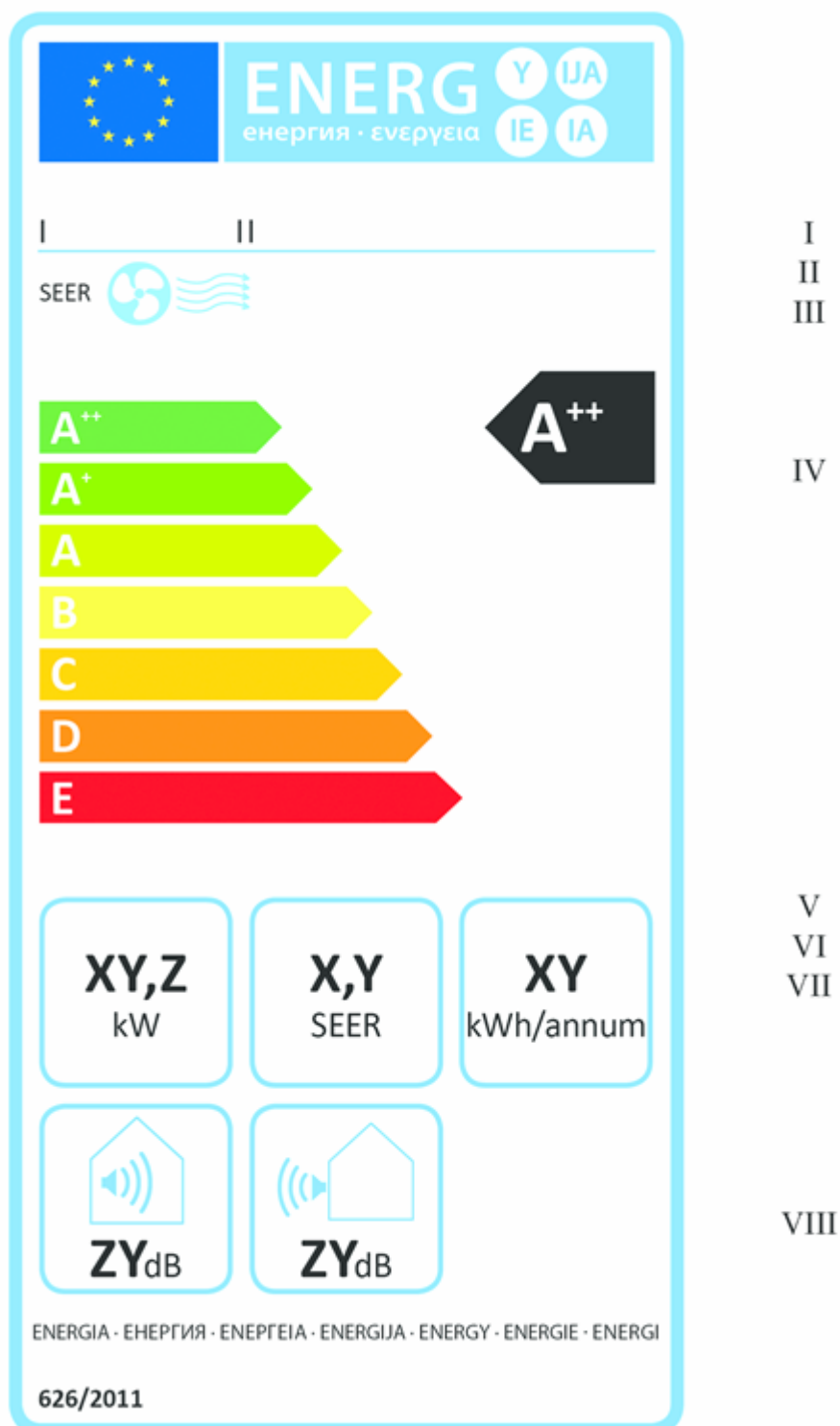

Changes to legislation: There are outstanding changes not yet made to Commission Delegated Regulation (EU) No 626/2011. Any changes that have already been made to the legislation appear in the content and are referenced with annotations. (See end of Document for details) [View outstanding changes](#)

- (a) The information listed in point 2.1 shall be included in the label.
 - (b) The design aspects of the label shall be in accordance with point 2.5.
- 2.4. **Cooling-only air conditioners classified in energy efficiency classes A+++ to D U.K.**

Changes to legislation: There are outstanding changes not yet made to Commission Delegated Regulation (EU) No 626/2011. Any changes that have already been made to the legislation appear in the content and are referenced with annotations. (See end of Document for details) View outstanding changes

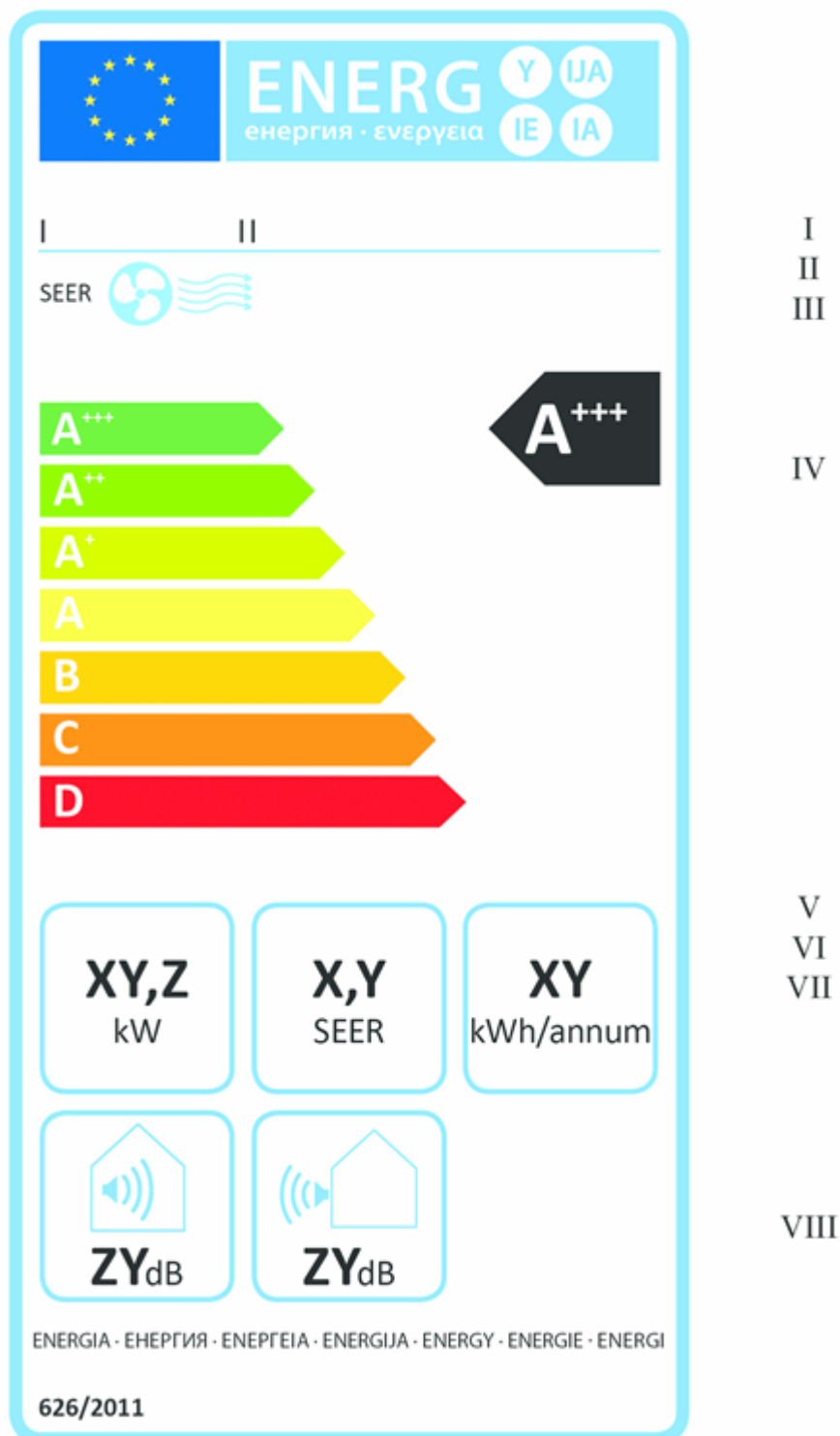

- (a) The information listed in point 2.1 shall be included in the label.
- (b) The design aspects of the label shall be in accordance with point 2.5.

Changes to legislation: There are outstanding changes not yet made to Commission Delegated Regulation (EU) No 626/2011. Any changes that have already been made to the legislation appear in the content and are referenced with annotations. (See end of Document for details) [View outstanding changes](#)

2.5. Label design **U.K.**

Changes to legislation: There are outstanding changes not yet made to Commission Delegated Regulation (EU) No 626/2011. Any changes that have already been made to the legislation appear in the content and are referenced with annotations. (See end of Document for details) View outstanding changes

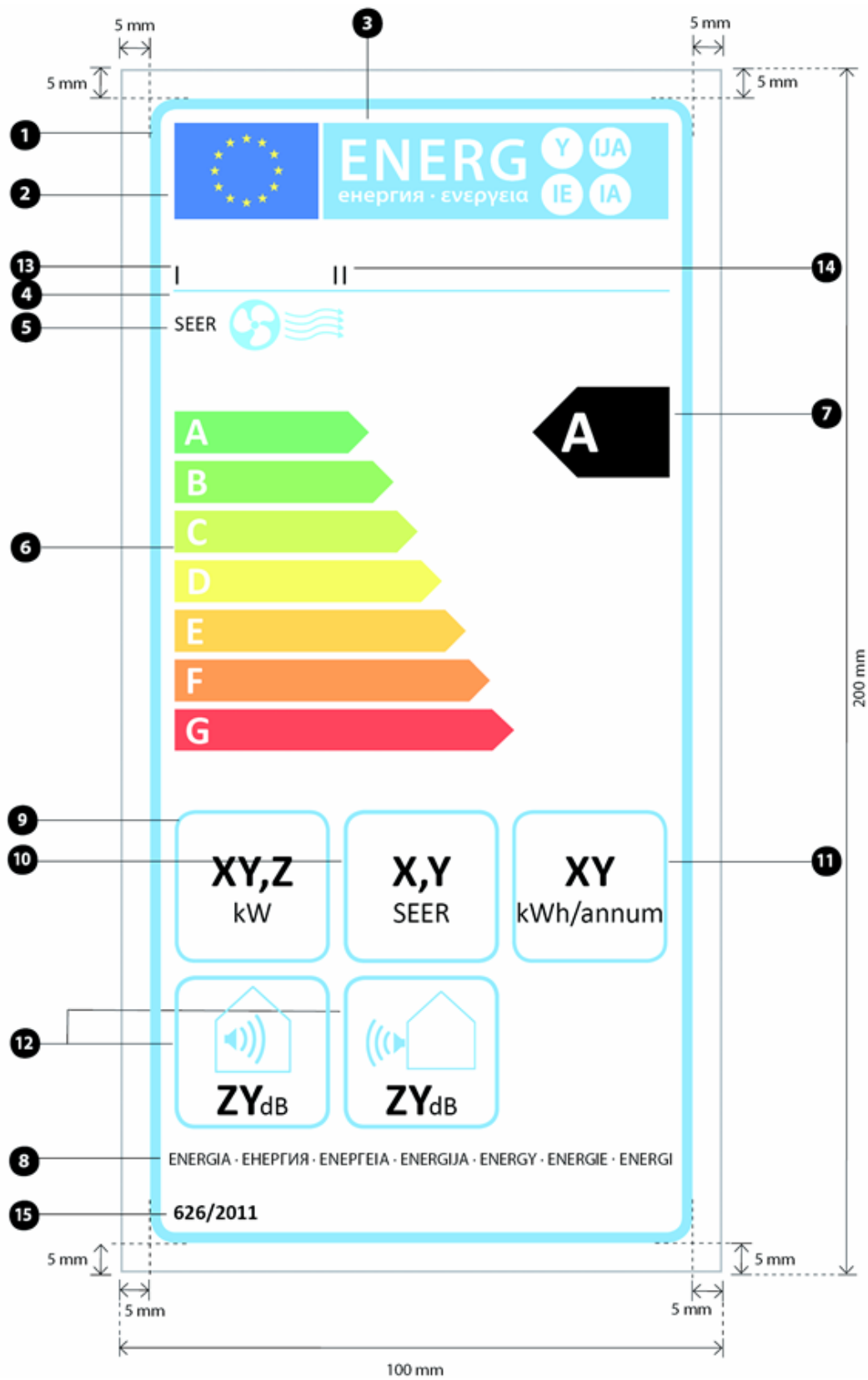

Changes to legislation: There are outstanding changes not yet made to Commission Delegated Regulation (EU) No 626/2011. Any changes that have already been made to the legislation appear in the content and are referenced with annotations. (See end of Document for details) View outstanding changes

Whereby:

- (i) The label shall be at least 100 mm wide and 200 mm high. Where the label is printed in a larger format, its content shall nevertheless remain proportionate to the specifications above.
- (ii) The background shall be white.
- (iii) Colours are coded as CMYK — cyan, magenta, yellow and black, following this example: 00-70-X-00: 0 % cyan, 70 % magenta, 100 % yellow, 0 % black.
- (iv) The label shall fulfil all of the following requirements (numbers refer to the figure above):
 - 1 **EU label border:** stroke: 5 pt – colour: cyan 100 % – round corners: 3,5 mm.
 - 2 **EU logo:** Colours: X-80-00-00 and 00-00-X-00.
 - 3 **Energy label:**
Colour: X-00-00-00.
Pictogram as depicted: EU logo + energy label: width: 93 mm, height: 18 mm.
 - 4 **Sub-logos border:** 1 pt – colour: cyan 100 % – length: 93,7 mm.
 - 5 **SEER indication:**
Text: Calibri regular 10 pt, capitals, 100 % black.
 - 6 **A-G scale:**
 - **Arrow:** height: 7 mm, gap: 1,3 mm – colours:
Highest class: X-00-X-00,
Second class: 70-00-X-00,
Third class: 30-00-X-00,
Fourth class: 00-00-X-00,
Fifth class: 00-30-X-00,
Sixth class: 00-70-X-00,
Last class(es): 00-X-X-00.
 - **Text:** Calibri bold 18 pt, capitals, white.
 - 7 **Energy efficiency class:**
 - **Arrow:** Width: 23 mm, height: 15 mm, 100 % black;
 - **Text:** Calibri bold 29 pt, capitals, white.
 - 8 **Energy:**
 - **Text:** Calibri regular 8 pt, capitals, 100 % black.
 - 9 **Rated capacity in kW:**
 - Text ‘kW’:** Calibri regular 14 pt, 100 % black.
 - Value ‘XY,Z’:** Calibri bold 22 pt, 100 % black.
 - 10 **SEER value rounded up to one decimal:**
 - **Border:** 3 pt – colour: cyan 100 % – round corners: 3,5 mm.
 - **Text ‘SEER’:** Calibri regular 14 pt, capitals, 100 % black.

Changes to legislation: There are outstanding changes not yet made to Commission Delegated Regulation (EU) No 626/2011. Any changes that have already been made to the legislation appear in the content and are referenced with annotations. (See end of Document for details) View outstanding changes

- **Value ‘X,Y’:** Calibri bold 22 pt, 100 % black.
 - 11 **Annual energy consumption in kWh/annum:**
 - **Text ‘kWh/annum’:** Calibri regular 14 pt, 100 % black.
 - **Value ‘XY’:** Calibri bold 22 pt, 100 % black.
 - 12 **Noise emissions:**
 - **Border:** 2 pt – colour: cyan 100 % – round corners: 3,5 mm.
 - **Value:** Calibri bold 22 pt, 100 % black.
 - **Text:** Calibri regular 14 pt, 100 % black.
 - 13 **Supplier’s name or trademark.**
 - 14 **Supplier’s model identifier:**

The suppliers’ name or trade mark and model identifier should fit in a space of 90 × 15 mm.
 - 15 **Reference period:**
 - **Text:** Calibri bold 10 pt.
3. LABEL OF AIR CONDITIONERS, EXCEPT SINGLE DUCT AND DOUBLE DUCT AIR CONDITIONERS **U.K.**
- 3.1. **Heating-only air conditioners classified in energy efficiency classes A to G** **U.K.**

Changes to legislation: There are outstanding changes not yet made to Commission Delegated Regulation (EU) No 626/2011. Any changes that have already been made to the legislation appear in the content and are referenced with annotations. (See end of Document for details) View outstanding changes

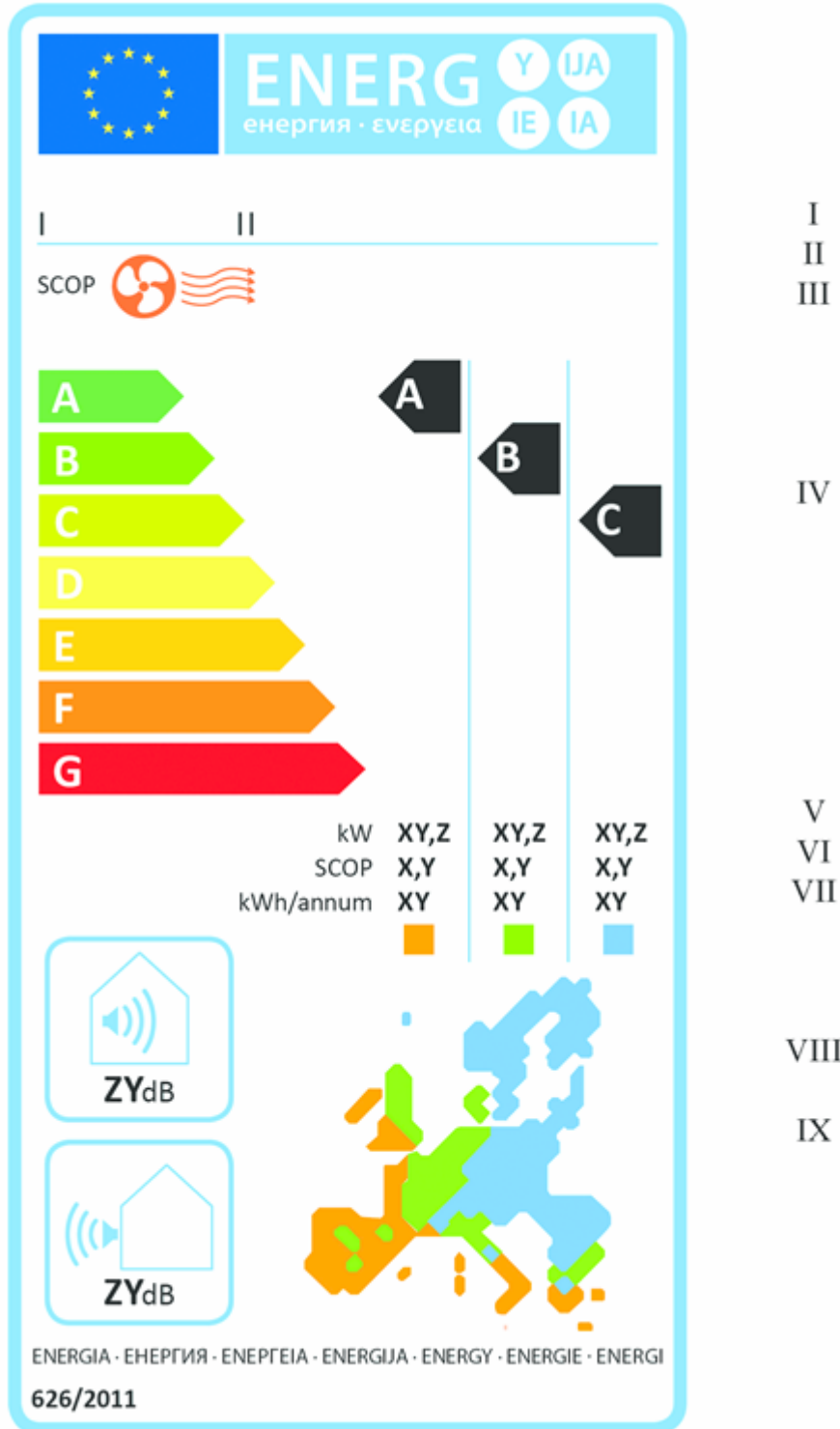

- (a) The following information shall be included in the label: U.K.
- I. supplier's name or trade mark;

Changes to legislation: There are outstanding changes not yet made to Commission Delegated Regulation (EU) No 626/2011. Any changes that have already been made to the legislation appear in the content and are referenced with annotations. (See end of Document for details) [View outstanding changes](#)

- II. supplier's model identifier;
- III. text 'SCOP', with red fan and air wave indication;
- IV. the energy efficiency; the head of the arrow containing the energy efficiency class of the appliance shall be placed at the same height as the head of the arrow of the relevant energy efficiency class. Energy efficiency for Average heating season is mandatory. Indication of efficiency for Warmer and Colder climates is optional;
- V. design load for heating in kW, for up to 3 heating seasons rounded up to one decimal. Values for heating seasons for which design load is not provided shall be indicated as 'X';
- VI. seasonal coefficient of performance (SCOP) for up to 3 heating seasons rounded up to one decimal. Values for heating seasons for which SCOP is not provided shall be indicated as 'X';
- VII. annual energy consumption in kWh per year, rounded up to the nearest integer. Values for heating seasons for which annual energy consumption is not provided shall be indicated as 'X';
- VIII. sound power levels for indoor and outdoor units expressed in dB(A) re1 pW, rounded to the nearest integer;
- IX. European map with a display of three indicative heating seasons and corresponding colour squares.

All the requested values shall be determined in accordance with Annex VII.

- (b) The design of the label shall be in accordance with point 3.5. By way of derogation, where a model has been granted an 'EU eco-label' under Regulation (EC) No 66/2010, a copy of the EU eco-label may be added.

3.2. **Heating-only air conditioners classified in energy efficiency classes A+ to F** U.K.

Changes to legislation: There are outstanding changes not yet made to Commission Delegated Regulation (EU) No 626/2011. Any changes that have already been made to the legislation appear in the content and are referenced with annotations. (See end of Document for details) View outstanding changes

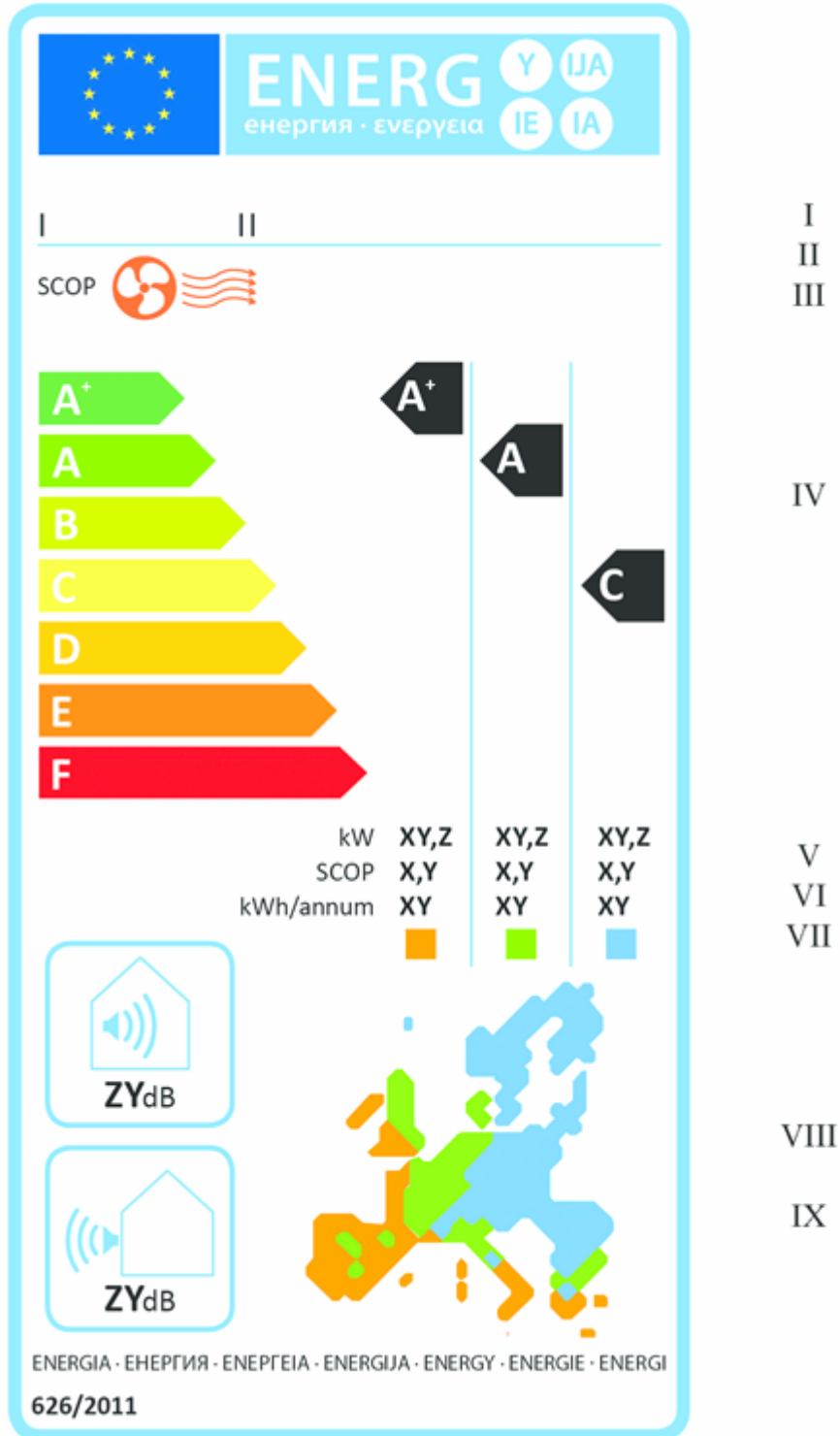

- (a) The information listed in point 3.1 shall be included in the label.
- (b) The design aspects of the label shall be in accordance with point 3.5.

Changes to legislation: There are outstanding changes not yet made to Commission Delegated Regulation (EU) No 626/2011. Any changes that have already been made to the legislation appear in the content and are referenced with annotations. (See end of Document for details) View outstanding changes

3.3. Heating-only air conditioners classified in energy efficiency classes A++ to E U.K.

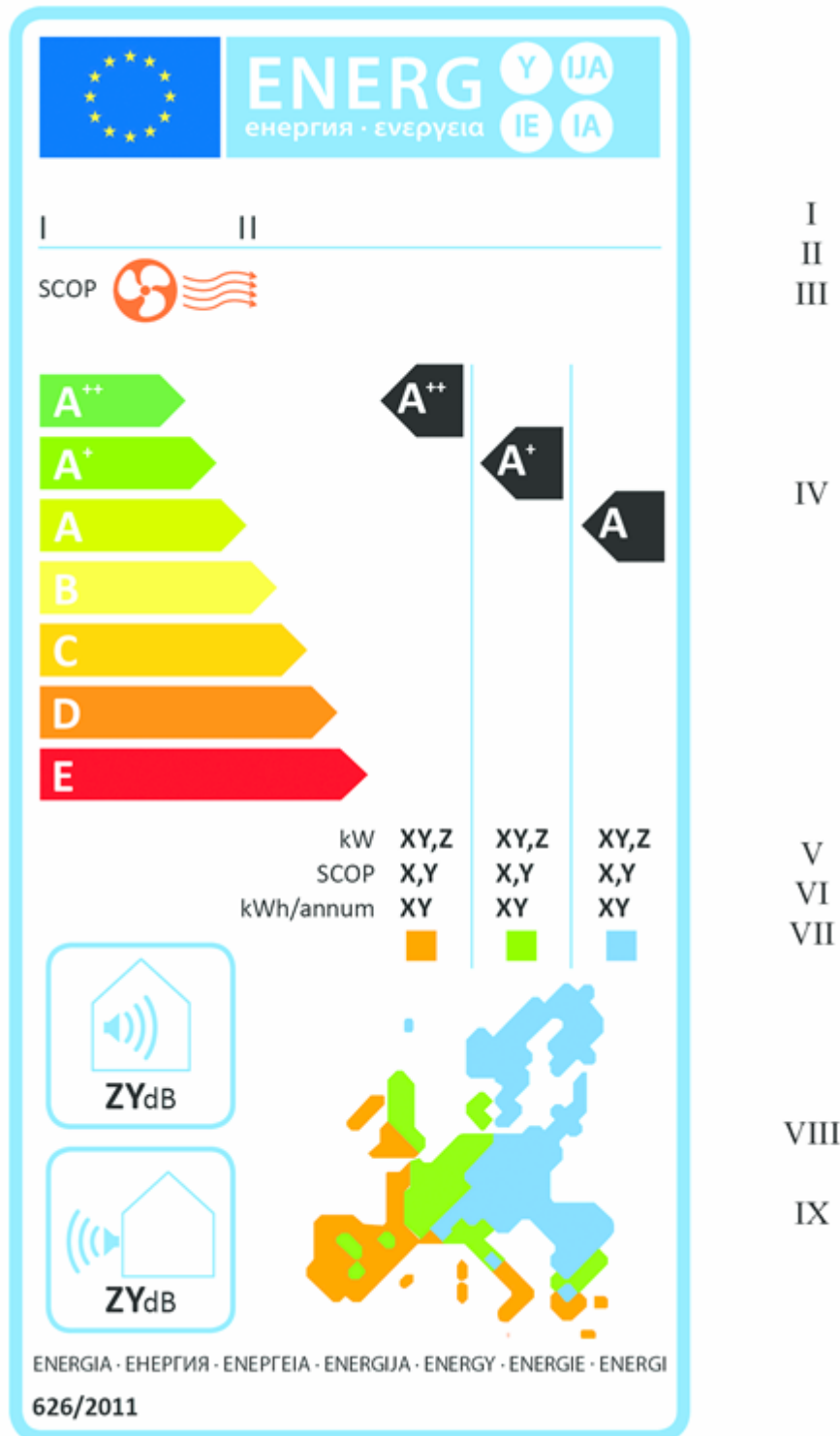

I
II
III
IV
V
VI
VII
VIII
IX

Changes to legislation: There are outstanding changes not yet made to Commission Delegated Regulation (EU) No 626/2011. Any changes that have already been made to the legislation appear in the content and are referenced with annotations. (See end of Document for details) [View outstanding changes](#)

- (a) The information listed in point 3.1 shall be included in the label.
 - (b) The design aspects of the label shall be in accordance with point 3.5.
- 3.4. **Heating-only air conditioners classified in energy efficiency classes A+++ to D U.K.**

Changes to legislation: There are outstanding changes not yet made to Commission Delegated Regulation (EU) No 626/2011. Any changes that have already been made to the legislation appear in the content and are referenced with annotations. (See end of Document for details) View outstanding changes

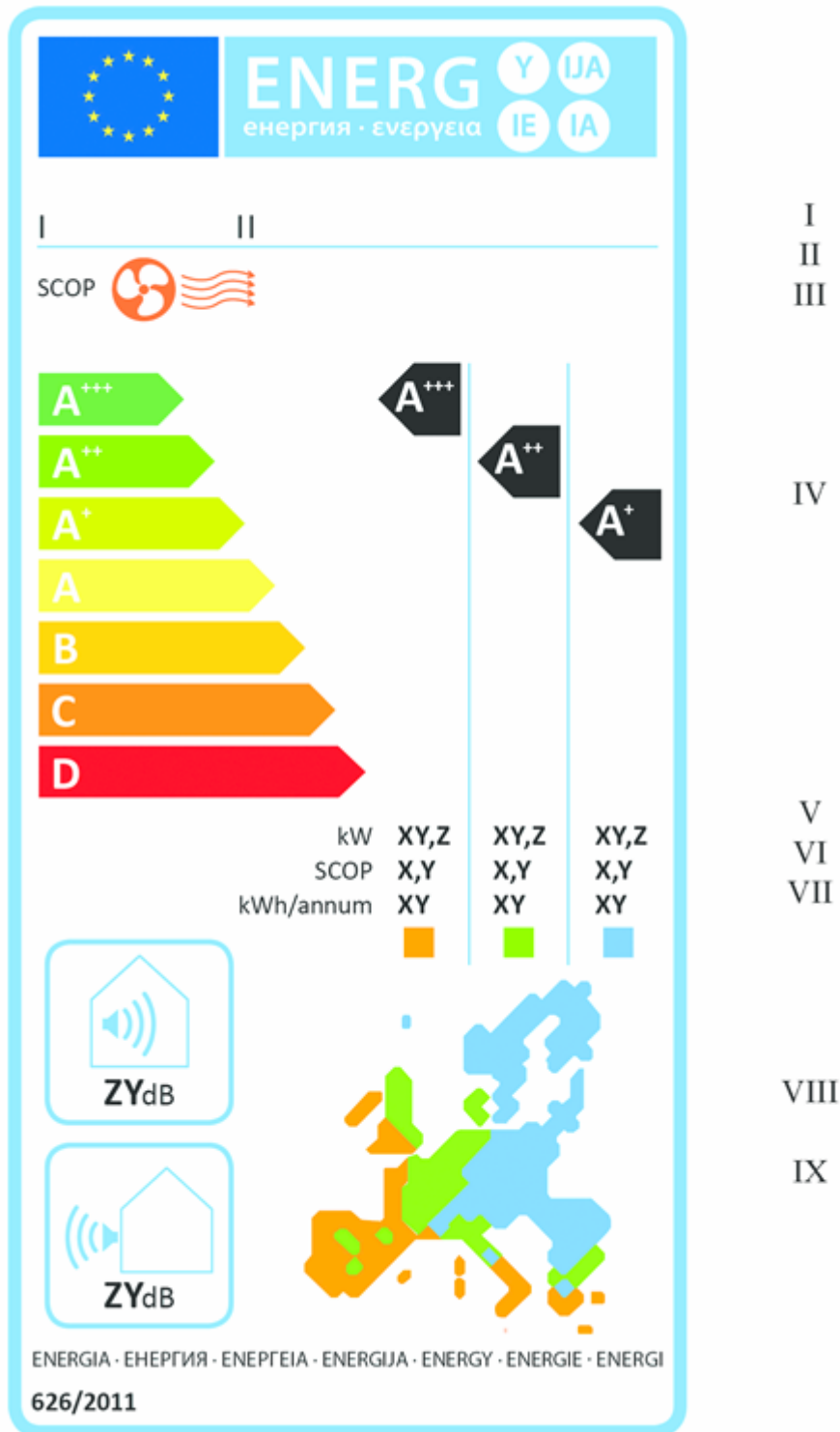

- (a) The information listed in point 3.1 shall be included in the label.
- (b) The design aspects of the label shall be in accordance with point 3.5.

Changes to legislation: There are outstanding changes not yet made to Commission Delegated Regulation (EU) No 626/2011. Any changes that have already been made to the legislation appear in the content and are referenced with annotations. (See end of Document for details) [View outstanding changes](#)

3.5. Label design **U.K.**

Changes to legislation: There are outstanding changes not yet made to Commission Delegated Regulation (EU) No 626/2011. Any changes that have already been made to the legislation appear in the content and are referenced with annotations. (See end of Document for details) View outstanding changes

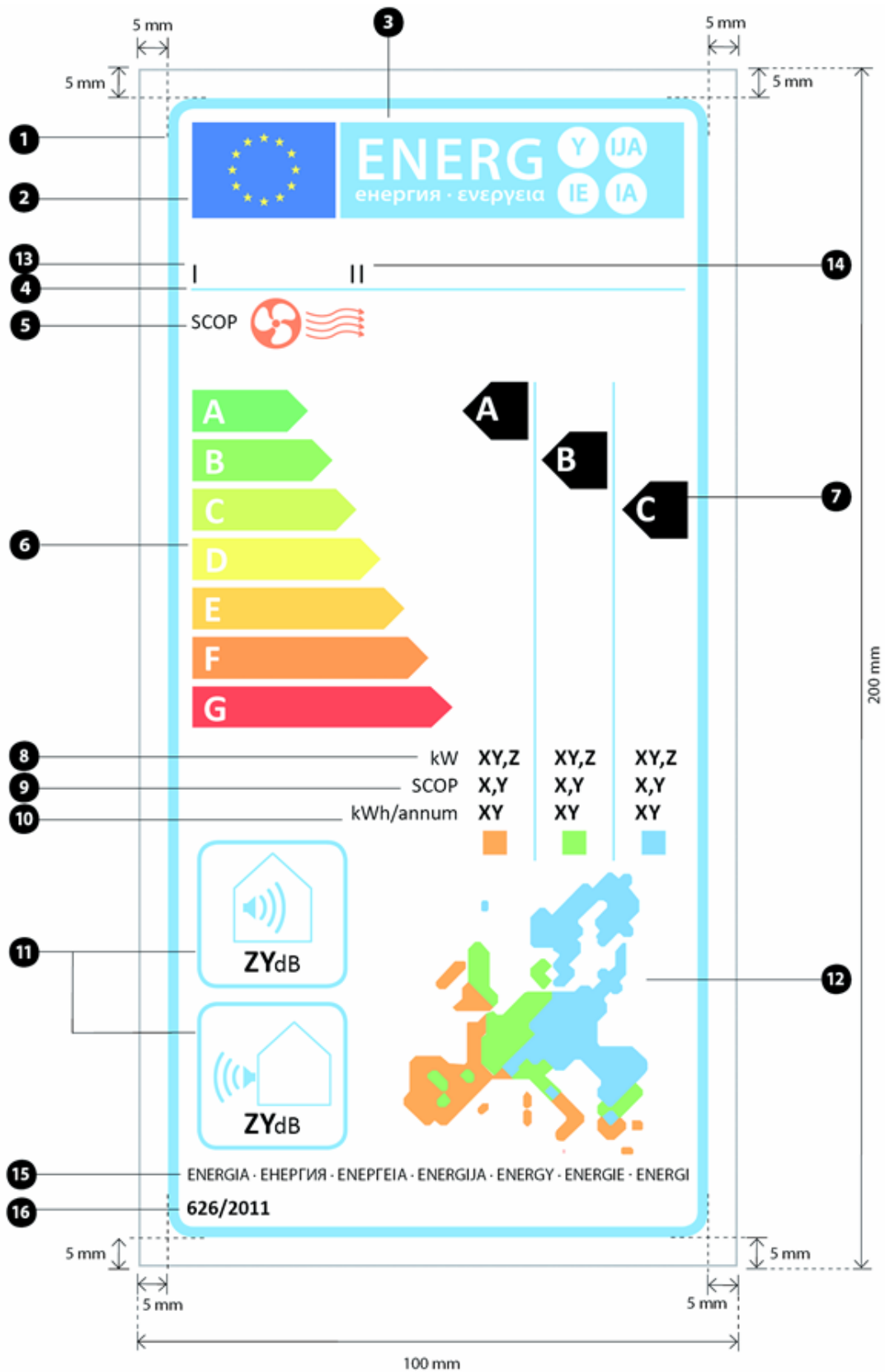

Changes to legislation: There are outstanding changes not yet made to Commission Delegated Regulation (EU) No 626/2011. Any changes that have already been made to the legislation appear in the content and are referenced with annotations. (See end of Document for details) View outstanding changes

Whereby:

- (i) The label shall be at least 100 mm wide and 200 mm high. Where the label is printed in a larger format, its content shall nevertheless remain proportionate to the specifications above.
- (ii) The background shall be white.
- (iii) Colours shall be CMYK — cyan, magenta, yellow and black, following this example: 00-70-X-00: 0 % cyan, 70 % magenta, 100 % yellow, 0 % black.
- (iv) The label shall fulfil all of the following requirements (numbers refer to the figure above):
 - 1 **EU label border:** stroke: 5 pt – colour: cyan 100 % – round corners: 3,5 mm.
 - 2 **EU logo:** Colours: X-80-00-00 and 00-00-X-00.
 - 3 **Energy label:** Colour: X-00-00-00.
Pictogram as depicted: EU logo + energy label: width: 93 mm, height: 18 mm.
 - 4 **Sub-logos border:** 1 pt – colour: cyan 100 % – length: 93,7 mm.
 - 5 **SCOP indication:**
Text: Calibri regular 10 pt, capitals, 100 % black.
 - 6 **A-G scale:**
 - **Arrow:** height: 7 mm, gap: 1,3 mm – **colours:**
Highest class: X-00-X-00,
Second class: 70-00-X-00,
Third class: 30-00-X-00,
Fourth class: 00-00-X-00,
Fifth class: 00-30-X-00,
Sixth class: 00-70-X-00,
Last class(es): 00-X-X-00.
 - **Text:** Calibri bold 18 pt, capitals, white.
 - 7 **Energy efficiency class(es):**
 - **Arrow:** width: 11 mm, height: 10 mm, 100 % black;
 - **Text:** Calibri bold 18 pt, capitals, white.
 - 8 **Rated capacity in kW:**
 - **Text ‘kW’:** Calibri regular 10 pt, 100 % black.
 - **Value ‘XY,Z’:** Calibri bold 11 pt, 100 % black.
 - 9 **SCOP values, rounded up to one decimal:**
 - **Text ‘SCOP’:** Calibri regular 10 pt, capitals, 100 % black.
 - **Value ‘X,Y’:** Calibri bold 11 pt, 100 % black.
 - 10 **Annual energy consumption in kWh/annum:**
 - **Text ‘kWh/annum’:** Calibri regular 10 pt, 100 % black.
 - **Value ‘XY’:** Calibri bold 11 pt, 100 % black.

Changes to legislation: There are outstanding changes not yet made to Commission Delegated Regulation (EU) No 626/2011. Any changes that have already been made to the legislation appear in the content and are referenced with annotations. (See end of Document for details) [View outstanding changes](#)

11 **Noise emissions:**

- **Border:** 2 pt – colour: cyan 100 % – round corners: 3,5 mm.
- **Value:** Calibri bold 15 pt, 100 % black.
- **Text:** Calibri regular 12 pt, 100 % black.

12 **European map and colour squares:**

Colours:

Orange: 00-46-46-00.

Green: 59-00-47-00.

Blue: 54-08-00-00.

13 **Supplier's name or trademark.**

14 **Supplier's model identifier:**

The suppliers' name or trade mark and model identifier should fit in a space of 90 × 15 mm.

15 **Energy:**

- **Text:** Calibri regular 8 pt, capitals, 100 % black.

16 **Reference period:**

- **Text:** Calibri bold 10, pt.

4. LABEL OF DOUBLE DUCT AIR CONDITIONERS **U.K.**

4.1. **Reversible double duct air conditioners classified in energy efficiency classes A+++ to D** **U.K.**

Changes to legislation: There are outstanding changes not yet made to Commission Delegated Regulation (EU) No 626/2011. Any changes that have already been made to the legislation appear in the content and are referenced with annotations. (See end of Document for details) View outstanding changes

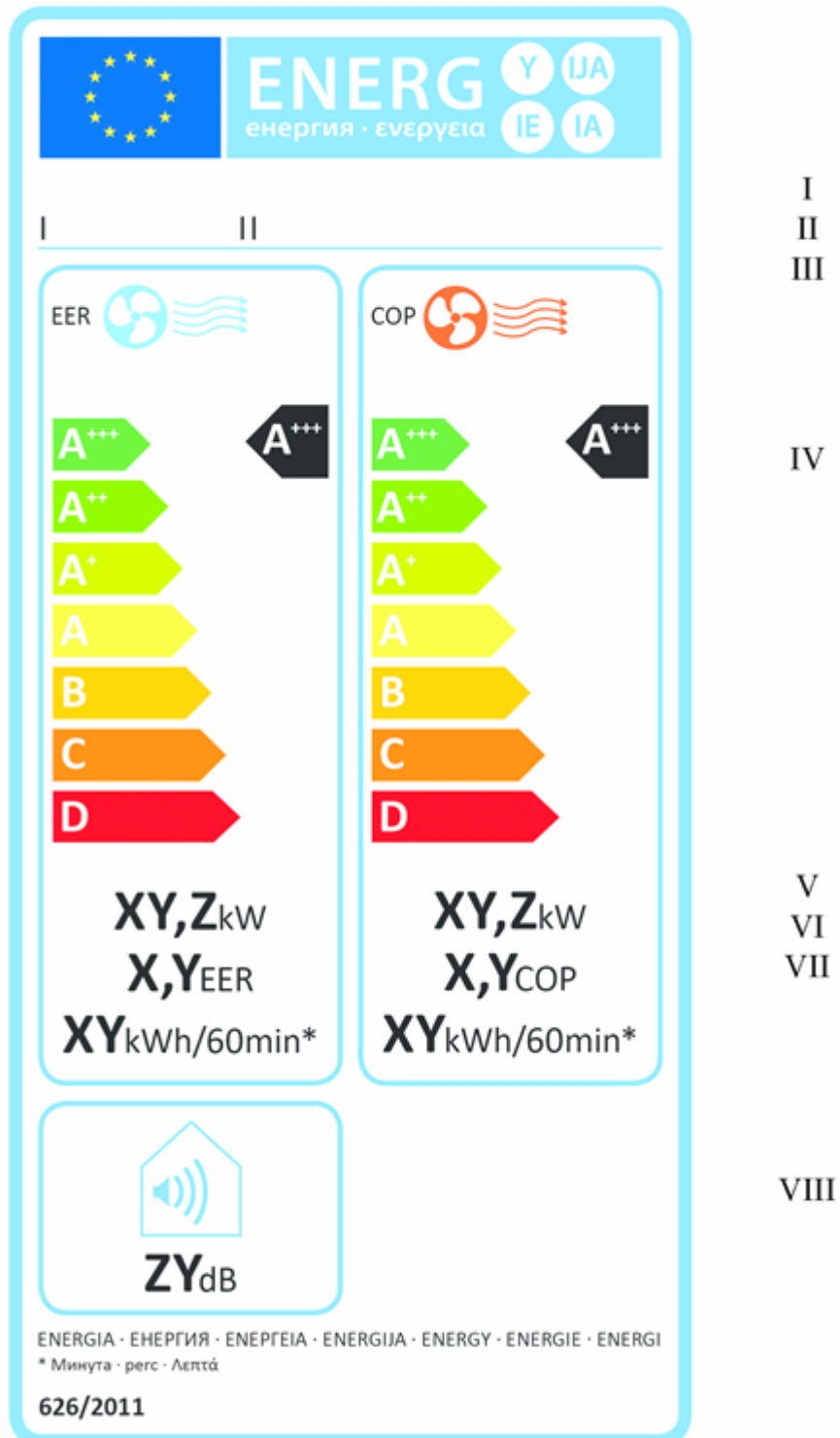

(a) The following information shall be included in the label: U.K.

I. supplier's name or trade mark;

Changes to legislation: There are outstanding changes not yet made to Commission Delegated Regulation (EU) No 626/2011. Any changes that have already been made to the legislation appear in the content and are referenced with annotations. (See end of Document for details) View outstanding changes

- II. supplier's model identifier;
- III. text 'EER' and 'COP' for cooling and heating, with a blue fan and air wave indication for EER and red fan and air wave indication for COP;
- IV. the energy efficiency; the head of the arrow containing the energy efficiency class of the appliance shall be placed at the same height as the head of the arrow of the relevant energy efficiency class. Energy efficiency must be indicated for cooling and heating;
- V. Rated capacity for cooling and heating mode in kW, rounded up to one decimal;
- VI. EER_{rated} and COP_{rated} , rounded up to one decimal;
- VII. hourly energy consumption in kWh per 60 minutes, for cooling and heating mode, rounded up to the nearest integer;
- VIII. sound power level for indoor unit expressed in dB(A) re 1 pW, rounded to the nearest integer.

All the requested values shall be determined in accordance with Annex VII.

- (b) The design of the label shall be in accordance with point 4.2. By way of derogation, where a model has been granted an 'EU eco-label' under Regulation (EC) No 66/2010, a copy of the EU eco-label may be added.

4.2. **Label Design** U.K.

Changes to legislation: There are outstanding changes not yet made to Commission Delegated Regulation (EU) No 626/2011. Any changes that have already been made to the legislation appear in the content and are referenced with annotations. (See end of Document for details) View outstanding changes

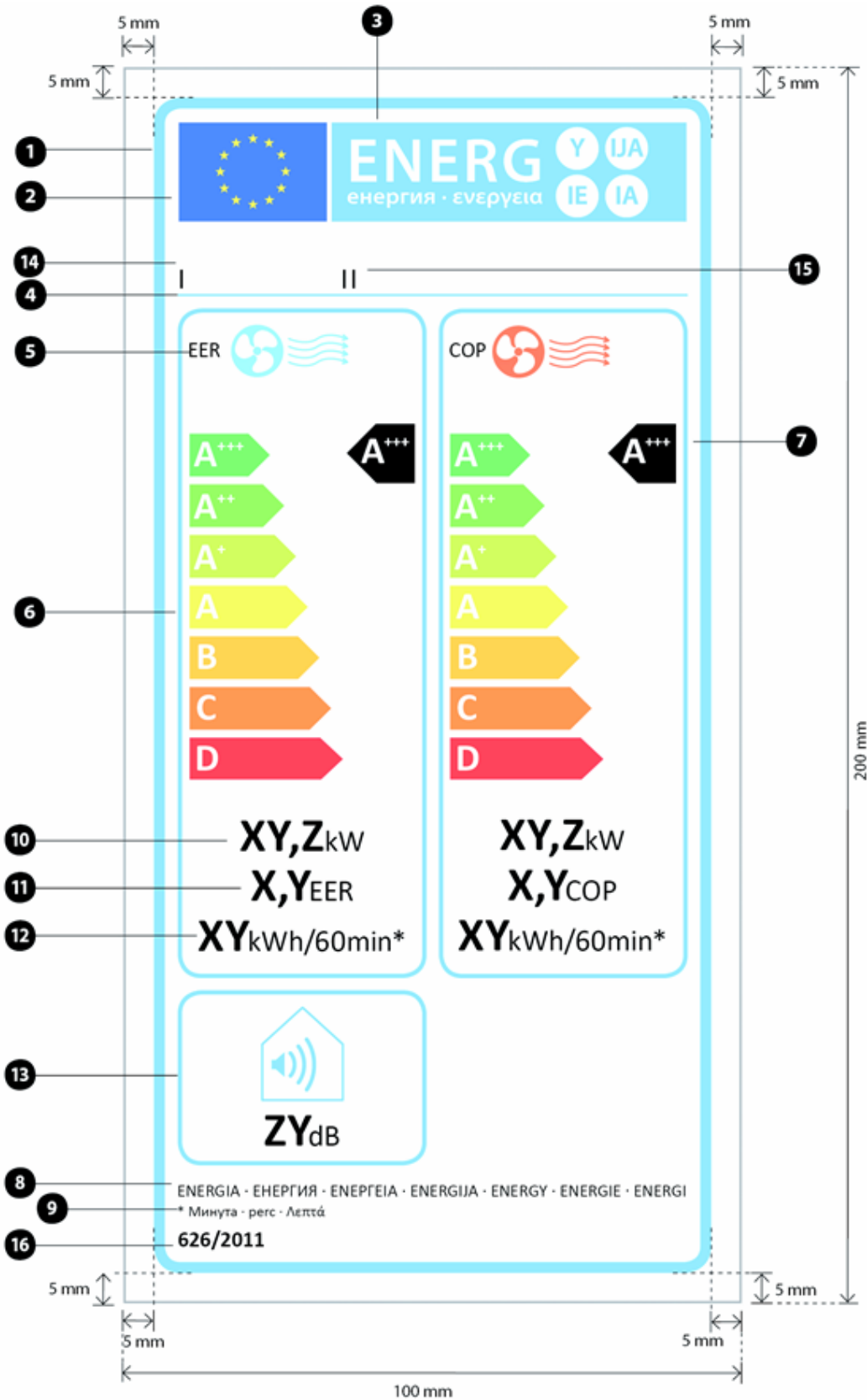

Changes to legislation: There are outstanding changes not yet made to Commission Delegated Regulation (EU) No 626/2011. Any changes that have already been made to the legislation appear in the content and are referenced with annotations. (See end of Document for details) View outstanding changes

Whereby:

- (i) The label shall be at least 100 mm wide and 200 mm high. Where the label is printed in a larger format, its content shall nevertheless remain proportionate to the specifications above.
- (ii) The background shall be white.
- (iii) Colours shall be CMYK — cyan, magenta, yellow and black, following this example: 00-70-X-00: 0 % cyan, 70 % magenta, 100 % yellow, 0 % black.
- (iv) The label shall fulfil all of the following requirements (numbers refer to the figure above):
 - 1 **EU label border:** stroke: 5 pt – colour: cyan 100 % – round corners: 3,5 mm.
 - 2 **EU logo:** Colours: X-80-00-00 and 00-00-X-00.
 - 3 **Energy label:** Colour: X-00-00-00.
Pictogram as depicted: EU logo + energy label: width: 82 mm, height: 16 mm.
 - 4 **Sub-logos border:** 1 pt – colour: cyan 100 % – length: 92,5 mm.
 - 5 **EER and COP indication:**
Text: Calibri regular 10 pt, 100 % black
 - 6 **A-G scale:**
 - **Arrow:** height: 7 mm, gap: 1,3 mm – colours:
Highest class: X-00-X-00,
Second class: 70-00-X-00,
Third class: 30-00-X-00,
Fourth class: 00-00-X-00,
Fifth class: 00-30-X-00,
Sixth class: 00-70-X-00,
Last class(es): 00-X-X-00.

Text:	Calibri bold 18 pt, capitals, white;
	Calibri bold 7 pt, white.
 - 7 **Energy efficiency classes:**
 - **Arrow:** width: 11 mm, height: 10 mm, 100 % black;

Text:	Calibri bold 18 pt, capitals, white.
	Calibri bold 7 pt, white.
 - 8 **Energy:**
 - **Text:** Calibri regular 8 pt, capitals, 100 % black.
 - 9 **‘Minutes’-translation:**
 - **Text:** Calibri regular 7 pt, 100 % black.

Changes to legislation: There are outstanding changes not yet made to Commission Delegated Regulation (EU) No 626/2011. Any changes that have already been made to the legislation appear in the content and are referenced with annotations. (See end of Document for details) View outstanding changes

- 10 **Rated capacity for cooling and heating mode in kW:**
 — **Text ‘kW’:** Calibri regular 14 pt, 100 % black.
 — **Value ‘XY,Z’:** Calibri bold 22 pt, 100 % black.
- 11 **COP and EER values, rounded up to one decimal:**
 — **Text ‘EER’/‘COP’:** Calibri regular 14 pt, capitals, 100 % black.
 — **Value ‘X,Y’:** Calibri bold 22 pt, 100 % black.
- 12 **Hourly energy consumption in kWh/60min:**
 — **Text ‘kWh/60min*’:** Calibri regular 14 pt, 100 % black.
 — **Value ‘XY’:** Calibri bold 22 pt, 100 % black.
- 13 **Noise emissions:**
 — **Border:** 2 pt – colour: cyan 100 % – round corners: 3,5 mm.
 — **Value:** Calibri bold 22 pt, 100 % black.
 — **Text:** Calibri regular 14 pt, 100 % black.
- 14 **Supplier’s name or trademark.**
- 15 **Supplier’s model identifier:**
 The suppliers’ name or trade mark and model identifier should fit in a space of 82 × 10,5 mm.
- 16 **Reference period:**
 — **Text:** Calibri bold 10 pt.

4.3. **Cooling-only double duct air conditioners classified in energy efficiency classes A+++ to D** **U.K.**

Changes to legislation: There are outstanding changes not yet made to Commission Delegated Regulation (EU) No 626/2011. Any changes that have already been made to the legislation appear in the content and are referenced with annotations. (See end of Document for details) View outstanding changes

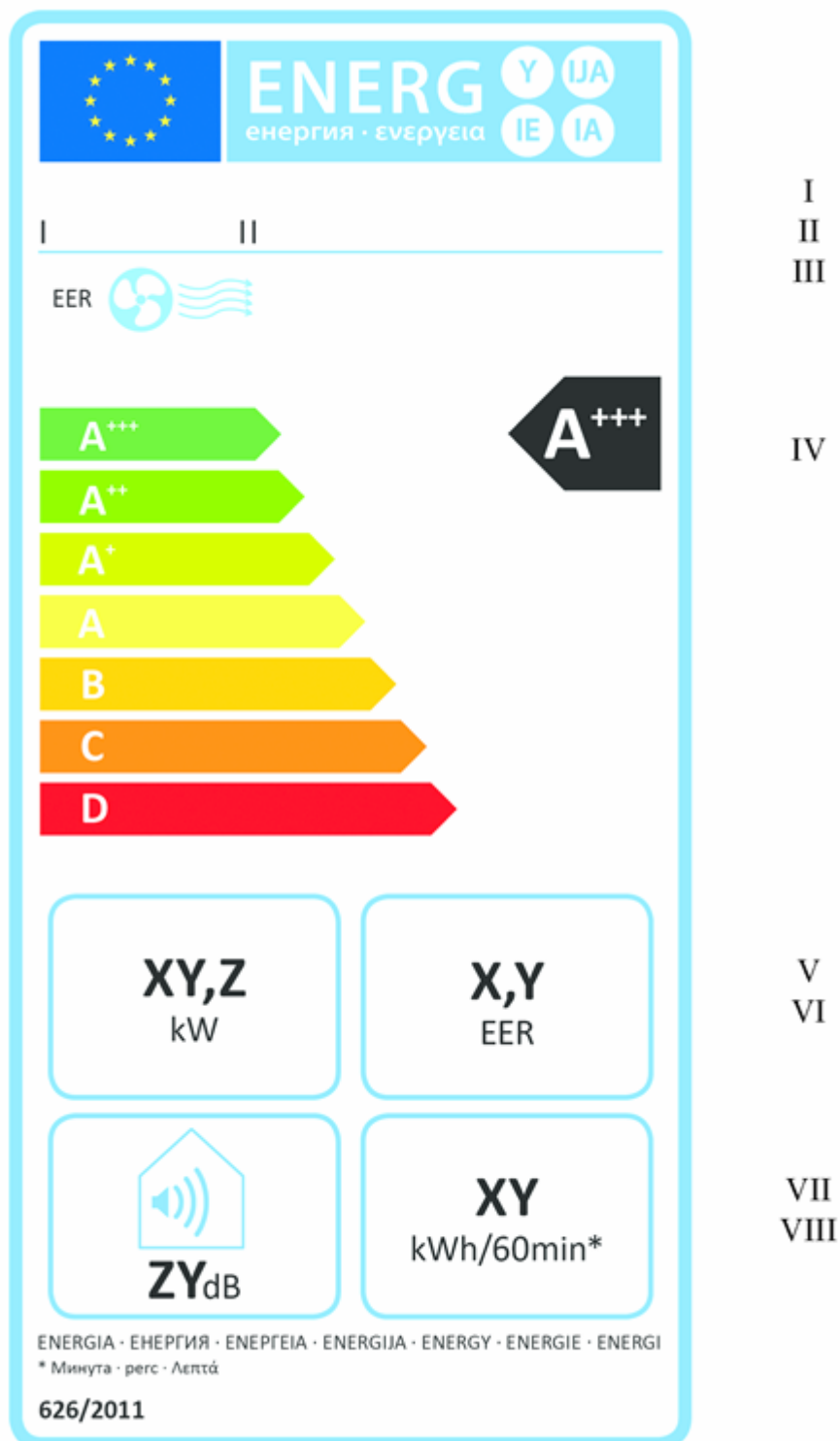

(a) The following information shall be included in the label: U.K.

I. supplier's name or trade mark;

Changes to legislation: There are outstanding changes not yet made to Commission Delegated Regulation (EU) No 626/2011. Any changes that have already been made to the legislation appear in the content and are referenced with annotations. (See end of Document for details) [View outstanding changes](#)

- II. supplier's model identifier;
- III. text 'EER', with a blue fan and air wave indication;
- IV. the energy efficiency; the head of the arrow containing the energy efficiency class of the appliance shall be placed at the same height as the head of the arrow of the relevant energy efficiency class;
- V. Rated capacity for cooling in kW, rounded up to one decimal;
- VI. EER_{rated} , rounded up to one decimal;
- VII. hourly energy consumption in kWh per 60 minutes, rounded up to the nearest integer;
- VIII. sound power level for indoor unit expressed in dB(A) re 1 pW, rounded to the nearest integer;

All the requested values shall be determined in accordance with Annex VII.

- (b) The design of the label shall be in accordance with point 4.4. By way of derogation, where a model has been granted an 'EU eco-label' under Regulation (EC) No 66/2010, a copy of the EU eco-label may be added.

4.4. **Label Design** U.K.

Changes to legislation: There are outstanding changes not yet made to Commission Delegated Regulation (EU) No 626/2011. Any changes that have already been made to the legislation appear in the content and are referenced with annotations. (See end of Document for details) View outstanding changes

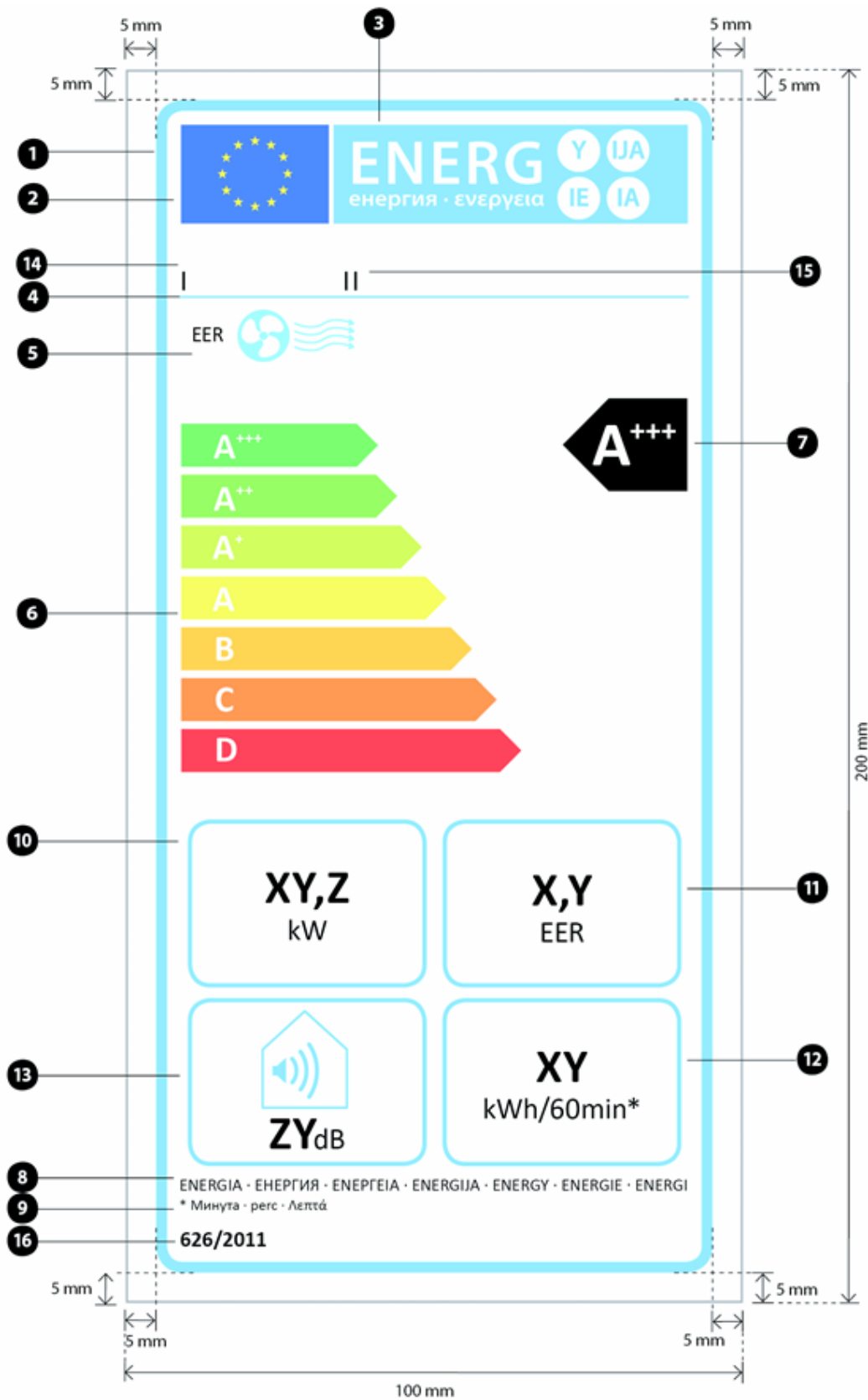

Changes to legislation: There are outstanding changes not yet made to Commission Delegated Regulation (EU) No 626/2011. Any changes that have already been made to the legislation appear in the content and are referenced with annotations. (See end of Document for details) View outstanding changes

Whereby:

- (i) The label shall be at least 100 mm wide and 200 mm high. Where the label is printed in a larger format, its content shall nevertheless remain proportionate to the specifications above.
- (ii) The background shall be white.
- (iii) Colours are coded as CMYK — cyan, magenta, yellow and black, following this example: 00-70-X-00: 0 % cyan, 70 % magenta, 100 % yellow, 0 % black.
- (iv) The label shall fulfil all of the following requirements (numbers refer to the figure above):
- 1 **EU label border:** stroke: 5 pt – colour: Cyan 100 % – round corners: 3,5 mm.
 - 2 **EU logo:** Colours: X-80-00-00 and 00-00-X-00.
 - 3 **Energy label:** Colour: X-00-00-00.
Pictogram as depicted: EU logo + energy label: width: 82 mm, height: 16 mm.
 - 4 **Sub-logos border:** 1 pt – colour: cyan 100 % – length: 92,5 mm.
 - 5 **EER indication:**
Text: Calibri regular 10 pt, capitals, 100 % black
 - 6 **A-G scale:**
 - **Arrow:** height: 7 mm, gap: 1,3 mm – **colours:**
Highest class: X-00-X-00,
Second class: 70-00-X-00,
Third class: 30-00-X-00,
Fourth class: 00-00-X-00,
Fifth class: 00-30-X-00,
Sixth class: 00-70-X-00,
Last class(es): 00-X-X-00.
 - | | |
|--------------|--------------------------------------|
| Text: | Calibri bold 18 pt, capitals, white; |
| | Calibri bold 7 pt, white. |
 - 7 **Energy efficiency class:**
 - **Arrow:** width: 20 mm, height: 15 mm, 100 % black;
 - | | |
|--------------|--------------------------------------|
| Text: | Calibri bold 30 pt, capitals, white; |
| | Calibri bold 14 pt, white. |
 - 8 **Energy**
 - **Text:** Calibri regular 8 pt, capitals, 100 % black.
 - 9 **‘Minutes’-translation:**

Changes to legislation: There are outstanding changes not yet made to Commission Delegated Regulation (EU) No 626/2011. Any changes that have already been made to the legislation appear in the content and are referenced with annotations. (See end of Document for details) [View outstanding changes](#)

— **Text:** Calibri regular 7 pt, 100 % black.

10 **Rated capacity in kW:**

— **Text ‘kW’:** Calibri regular 14 pt, 100 % black.

— **Value ‘XY,Z’:** Calibri bold 22 pt, 100 % black.

11 **EER value, rounded up to one decimal:**

— **Text ‘EER’:** Calibri regular 14 pt, capitals, 100 % black.

— **Value ‘X,Y’:** Calibri bold 22 pt, 100 % black.

12 **Hourly energy consumption in kWh/60min:**

— **Text ‘kWh/60min*’:** Calibri regular 14 pt, 100 % black.

— **Value ‘XY’:** Calibri bold 22 pt, 100 % black.

13 **Noise emissions:**

— **Border:** 2 pt – colour: 100 % cyan – round corners: 3,5 mm.

— **Value:** Calibri bold 22 pt, 100 % black.

— **Text:** Calibri regular 14 pt, 100 % black.

14 **Supplier’s name or trademark.**

15 **Supplier’s model identifier:**

The suppliers’ name or trade mark and model identifier should fit in a space of 82 × 10,5 mm.

16 **Reference period:**

— **Text:** Calibri bold 10 pt.

4.5. **Heating-only double duct air conditioners classified in energy efficiency classes A+++ to D U.K.**

Changes to legislation: There are outstanding changes not yet made to Commission Delegated Regulation (EU) No 626/2011. Any changes that have already been made to the legislation appear in the content and are referenced with annotations. (See end of Document for details) View outstanding changes

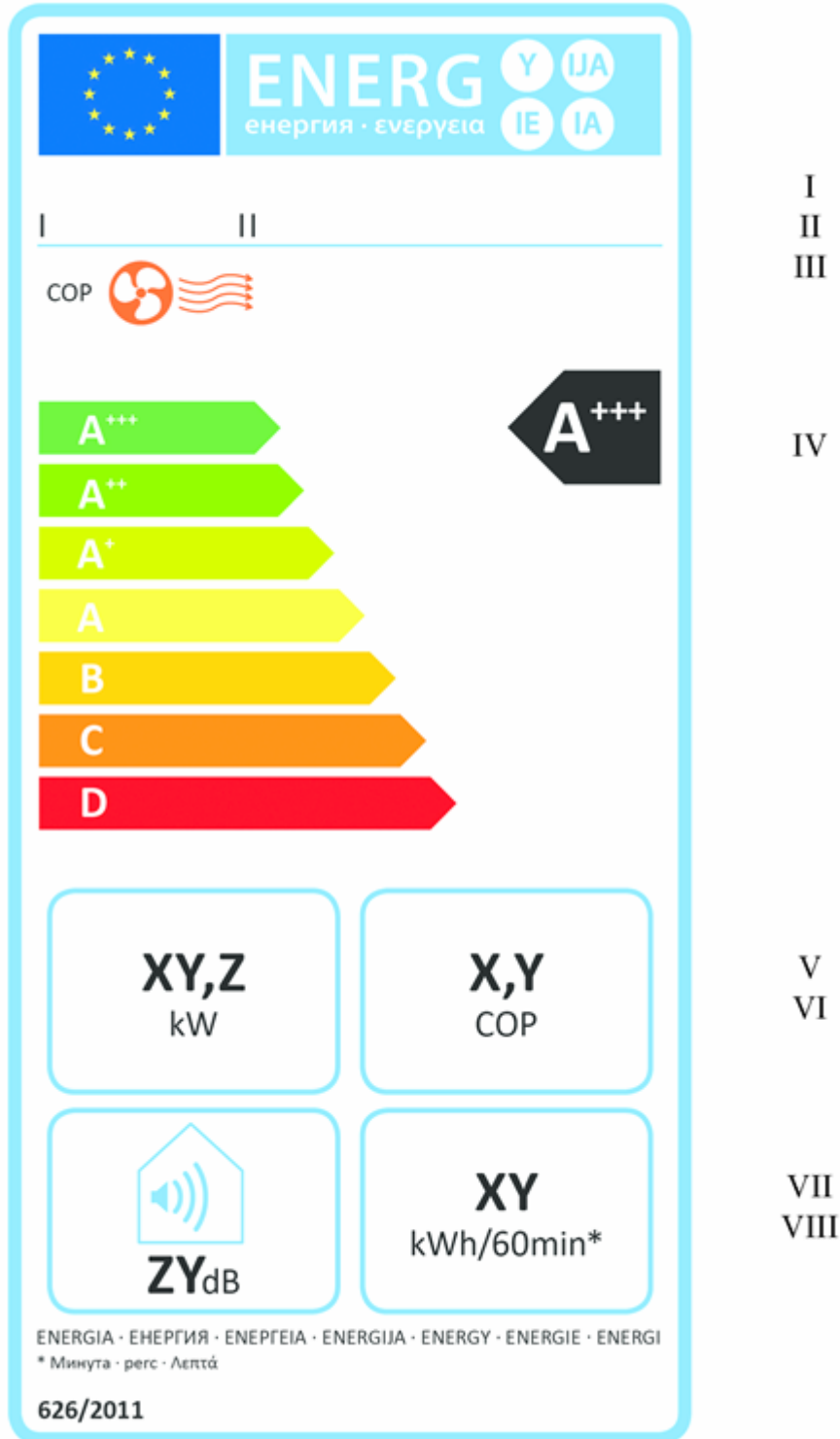

- (a) The following information shall be included in the label: **U.K.**
- I. supplier's name or trade mark;

Changes to legislation: There are outstanding changes not yet made to Commission Delegated Regulation (EU) No 626/2011. Any changes that have already been made to the legislation appear in the content and are referenced with annotations. (See end of Document for details) [View outstanding changes](#)

- II. supplier's model identifier;
- III. text 'COP' with red fan and air wave indication;
- IV. the energy efficiency; the head of the arrow containing the energy efficiency class of the appliance shall be placed at the same height as the head of the arrow of the relevant energy efficiency class;
- V. rated capacity for heating in kW, rounded up to one decimal;
- VI. COP_{rated} , rounded up to one decimal;
- VII. hourly energy consumption in kWh per 60 minutes, rounded up to the nearest integer;
- VIII. sound power level for indoor unit expressed in dB(A) re 1 pW, rounded to the nearest integer.

All the requested values shall be determined in accordance with Annex VII.

- (b) The design of the label shall be in accordance with point 4.6. By way of derogation, where a model has been granted an 'EU eco-label' under Regulation (EC) No 66/2010, a copy of the EU eco-label may be added.

4.6. **Label Design** U.K.

Changes to legislation: There are outstanding changes not yet made to Commission Delegated Regulation (EU) No 626/2011. Any changes that have already been made to the legislation appear in the content and are referenced with annotations. (See end of Document for details) View outstanding changes

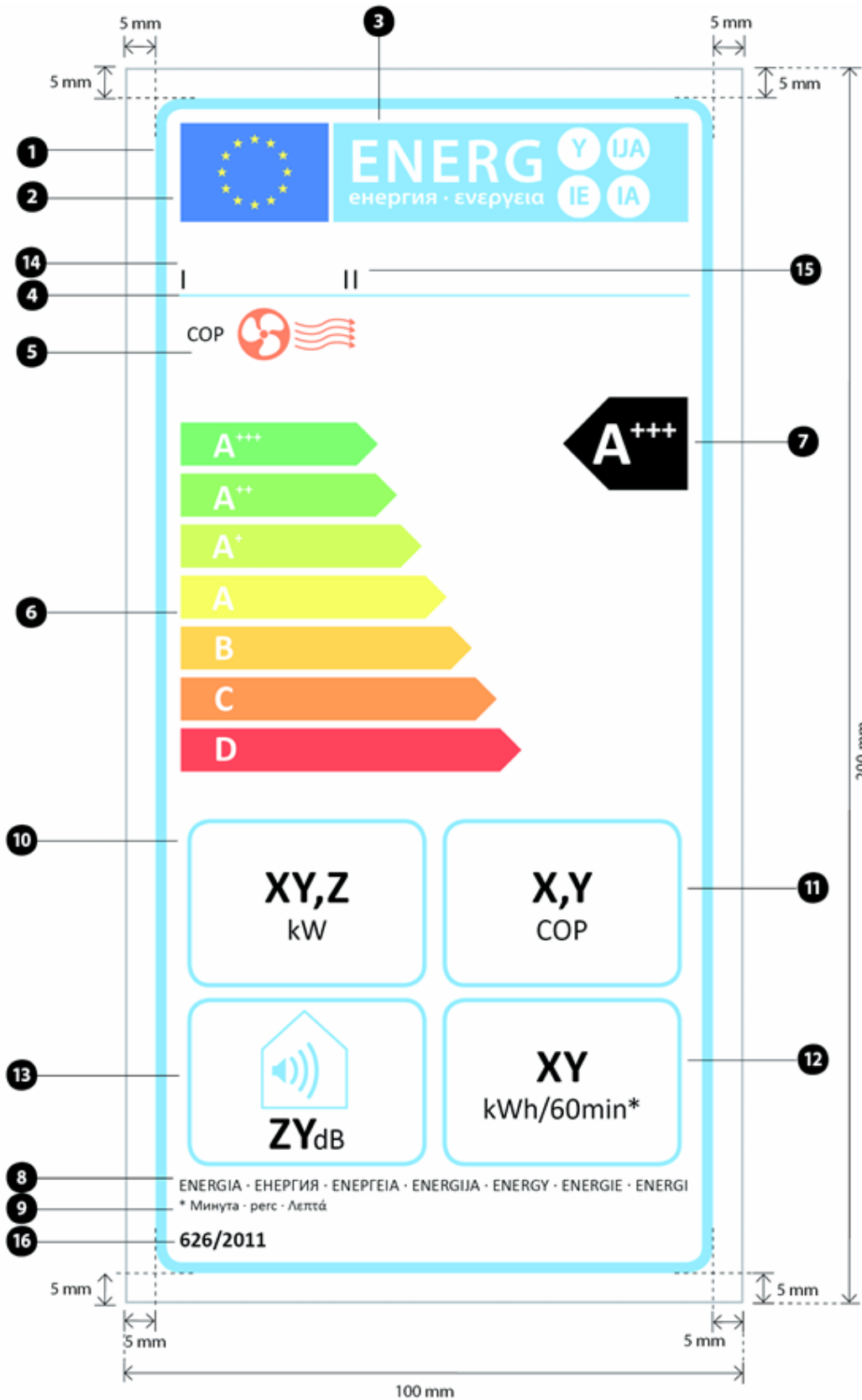

Changes to legislation: There are outstanding changes not yet made to Commission Delegated Regulation (EU) No 626/2011. Any changes that have already been made to the legislation appear in the content and are referenced with annotations. (See end of Document for details) View outstanding changes

Whereby:

- (i) The label shall be at least 100 mm wide and 200 mm high. Where the label is printed in a larger format, its content shall nevertheless remain proportionate to the specifications above.
- (ii) The background shall be white.
- (iii) Colours are coded as CMYK — cyan, magenta, yellow and black, following this example: 00-70-X-00: 0 % cyan, 70 % magenta, 100 % yellow, 0 % black.
- (iv) The label shall fulfil all of the following requirements (numbers refer to the figure above):
 - 1 **EU label border:** stroke: 5 pt – colour: cyan 100 % – round corners: 3,5 mm.
 - 2 **EU logo:** Colours: X-80-00-00 and 00-00-X-00.
 - 3 **Energy label:** Colour: X-00-00-00.
Pictogram as depicted: EU logo + energy label: width: 82 mm, height: 16 mm.
 - 4 **Sub-logos border:** 1 pt – colour: 100 % cyan – length: 92,5 mm.
 - 5 **COP indication:**
Text: Calibri regular 10 pt, capitals, 100 % black
 - 6 **A-G scale:**
 - **Arrow:** height: 7 mm, gap: 1,3 mm – colours:
Highest class: X-00-X-00,
Second class: 70-00-X-00,
Third class: 30-00-X-00,
Fourth class: 00-00-X-00,
Fifth class: 00-30-X-00,
Sixth class: 00-70-X-00,
Last class(es): 00-X-X-00.

Text:	Calibri Bold 18 pt, capitals, white;
	Calibri bold 7 pt, white.
 - 7 **Energy efficiency class:**
 - **Arrow:** width: 20 mm, height: 15 mm, 100 % black;

Text:	Calibri bold 30 pt, capitals, white;
	Calibri bold 14 pt, white.
 - 8 **Energy:**
 - **Text:** Calibri regular 8 pt, capitals, 100 % black.
 - 9 **‘Minutes’-translation:**
 - **Text:** Calibri regular 7 pt, 100 % black.

Changes to legislation: There are outstanding changes not yet made to Commission Delegated Regulation (EU) No 626/2011. Any changes that have already been made to the legislation appear in the content and are referenced with annotations. (See end of Document for details) View outstanding changes

10 **Rated capacity in kW:**

- **Text ‘kW’:** Calibri regular 14 pt, 100 % black.
- **Value ‘XY,Z’:** Calibri bold 22 pt, 100 % black.

11 **COP value, rounded up to one decimal:**

- **Text ‘COP’:** Calibri regular 14 pt, capitals, 100 % black.
- **Value ‘X,Y’:** Calibri bold 22 pt, 100 % black.

12 **Hourly energy consumption in kWh/60min:**

- **Text ‘kWh/60min*’:** Calibri regular 14 pt, 100 % black.
- **Value ‘XY’:** Calibri bold 22 pt, 100 % black.

13 **Noise emissions:**

- **Border:** 2 pt – colour: cyan 100 % – round corners: 3,5 mm.
- **Value:** Calibri bold 22 pt, 100 % black.
- **Text:** Calibri regular 14 pt, 100 % black.

14 **Supplier’s name or trademark.**

15 **Supplier’s model identifier:**

The suppliers’ name or trade mark and model identifier should fit in a space of 82 × 10,5 mm.

16 **Reference period:**

- **Text:** Calibri bold 10 pt.

5. LABEL OF SINGLE DUCT AIR CONDITIONERS **U.K.**

5.1. **Reversible single duct air conditioners classified in energy efficiency classes A+ ++ to D** **U.K.**

Changes to legislation: There are outstanding changes not yet made to Commission Delegated Regulation (EU) No 626/2011. Any changes that have already been made to the legislation appear in the content and are referenced with annotations. (See end of Document for details) View outstanding changes

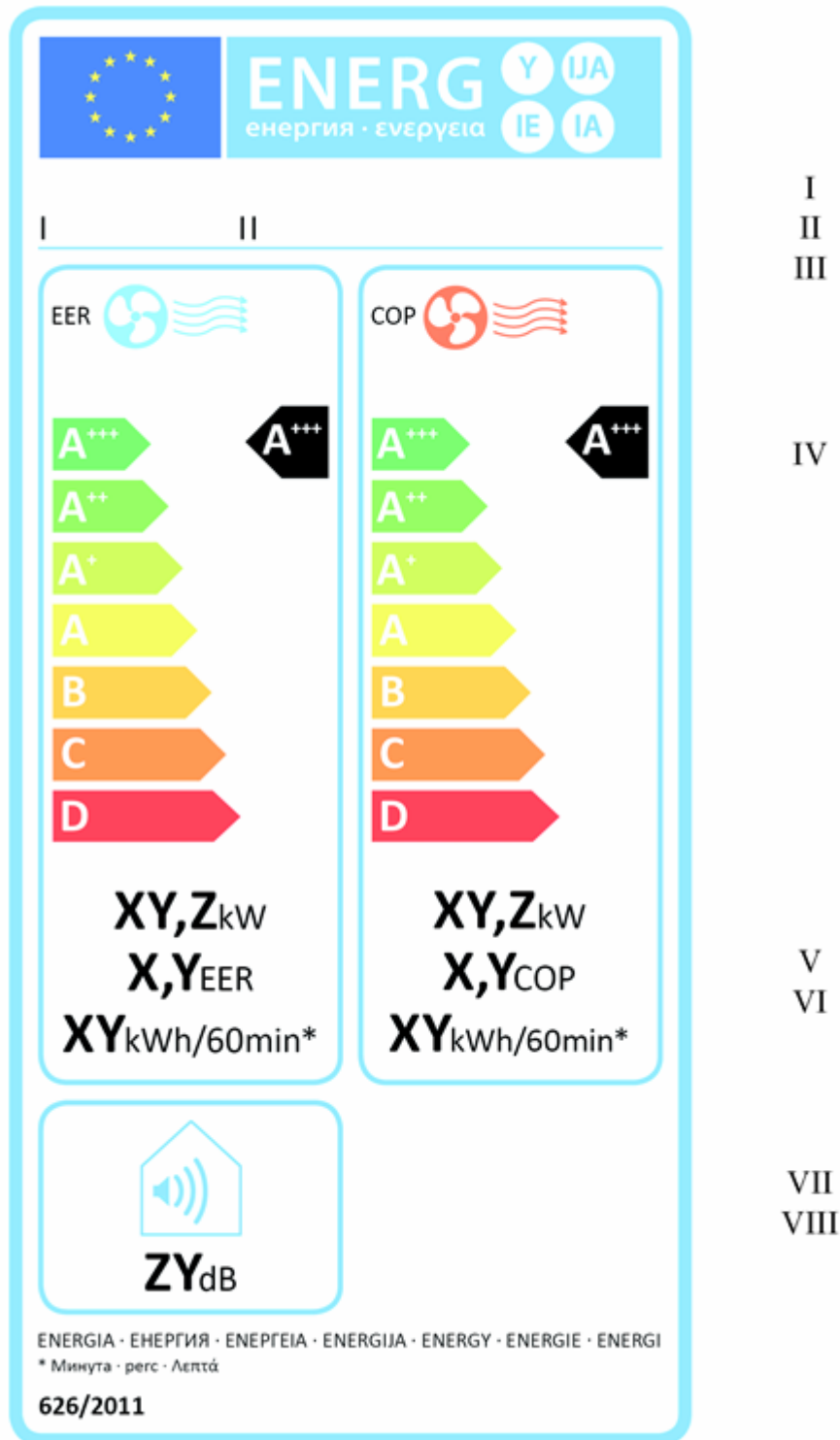

- (a) The following information shall be included in the label: **U.K.**
- I. supplier's name or trade mark;

Changes to legislation: There are outstanding changes not yet made to Commission Delegated Regulation (EU) No 626/2011. Any changes that have already been made to the legislation appear in the content and are referenced with annotations. (See end of Document for details) View outstanding changes

- II. supplier's model identifier;
- III. text 'EER' and 'COP' for cooling and heating, with a blue fan and air wave indication for EER and red fan and air wave indication for COP;
- IV. the energy efficiency; the head of the arrow containing the energy efficiency class of the appliance shall be placed at the same height as the head of the arrow of the relevant energy efficiency class. Energy efficiency must be indicated for cooling and heating;
- V. rated capacity for cooling and heating mode in kW, rounded up to one decimal;
- VI. EER_{rated} and COP_{rated} , rounded up to one decimal;
- VII. [^{F1}hourly energy consumption in kWh per 60 minutes, for cooling and heating, rounded up to the nearest integer;]
- VIII. sound power level for indoor unit expressed in dB(A) re 1 pW, rounded to the nearest integer.

All the requested values shall be determined in accordance with Annex VII.

Textual Amendments

- F1** Substituted by [Commission Delegated Regulation \(EU\) 2020/1059 of 27 April 2020 correcting certain language versions of Delegated Regulations \(EU\) No 1059/2010, \(EU\) No 1060/2010, \(EU\) No 1061/2010, \(EU\) No 1062/2010, \(EU\) No 626/2011, \(EU\) No 392/2012 and \(EU\) No 874/2012 with regard to the labelling of certain energy-related products \(Text with EEA relevance\).](#)

- (b) The design of the label shall be in accordance with point 5.2. By way of derogation, where a model has been granted an 'EU eco-label' under Regulation (EC) No 66/2010, a copy of the EU eco-label may be added.

5.2. Label Design **U.K.**

Changes to legislation: There are outstanding changes not yet made to Commission Delegated Regulation (EU) No 626/2011. Any changes that have already been made to the legislation appear in the content and are referenced with annotations. (See end of Document for details) View outstanding changes

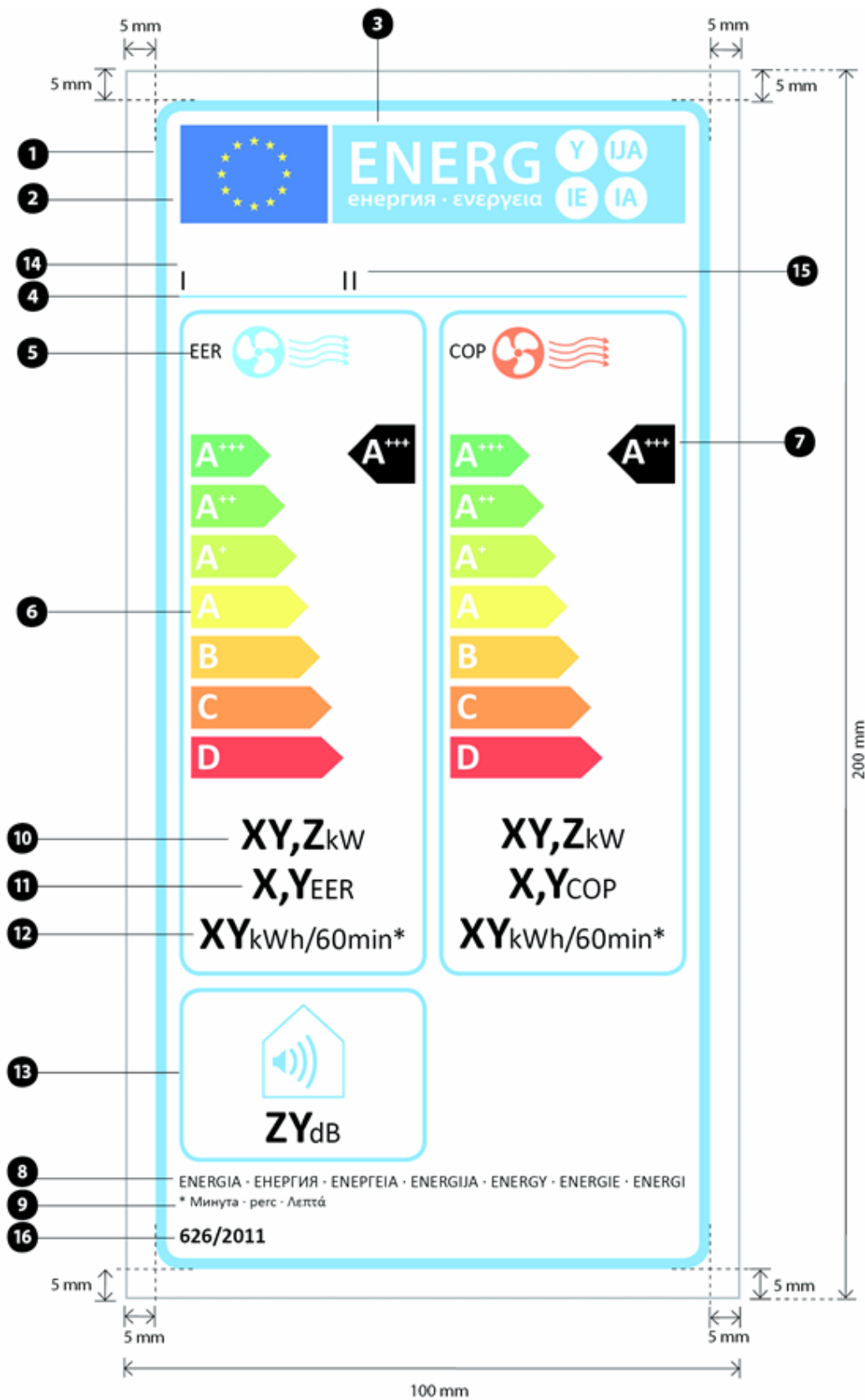

Changes to legislation: There are outstanding changes not yet made to Commission Delegated Regulation (EU) No 626/2011. Any changes that have already been made to the legislation appear in the content and are referenced with annotations. (See end of Document for details) View outstanding changes

Whereby:

- (i) The label shall be at least 100 mm wide and 200 mm high. Where the label is printed in a larger format, its content shall nevertheless remain proportionate to the specifications above.
- (ii) The background shall be white.
- (iii) Colours are coded as CMYK — cyan, magenta, yellow and black, following this example: 00-70-X-00: 0 % cyan, 70 % magenta, 100 % yellow, 0 % black.
- (iv) The label shall fulfil all of the following requirements (numbers refer to the figure above):
- 1 **EU label border:** stroke: 5 pt – colour: cyan 100 % – round corners: 3,5 mm.
 - 2 **EU logo:** Colours: X-80-00-00 and 00-00-X-00.
 - 3 **Energy label:** Colour: X-00-00-00.
Pictogram as depicted: EU logo + energy label: width: 82 mm, height: 16 mm.
 - 4 **Sub-logos border:** 1 pt – colour: cyan 100 % – length: 92,5 mm.
 - 5 **EER and COP indication:**
 - **Border:** 2 pt – colour: cyan 100 % – round corners: 3,5 mm.
 - **Text:** Calibri regular 10 pt, capitals, 100 % black.
 - 6 **A-G scale:**
 - **Arrow:** height: 7 mm, gap: 1,3 mm – colours:
 - Highest class: X-00-X-00,
 - Second class: 70-00-X-00,
 - Third class: 30-00-X-00,
 - Fourth class: 00-00-X-00,
 - Fifth class: 00-30-X-00,
 - Sixth class: 00-70-X-00,
 - Last class(es): 00-X-X-00.

Text:	Calibri bold 18 pt, capitals, white;
	Calibri bold 7 pt, white.
 - 7 **Energy efficiency classes:**
 - **Arrow:** Width: 11 mm, height: 10 mm, 100 % black;
 - **Text:** Calibri bold 18 pt, capitals, white.
 - 8 **Energy:**
 - **Text:** Calibri regular 8 pt, capitals, 100 % black.
 - 9 **‘Minutes’-translation:**
 - **Text:** Calibri regular 7 pt, 100 % black.
 - 10 **Rated capacity for cooling and heating in kW:**
 - **Text ‘kW’:** Calibri regular 14 pt, 100 % black.

Changes to legislation: There are outstanding changes not yet made to Commission Delegated Regulation (EU) No 626/2011. Any changes that have already been made to the legislation appear in the content and are referenced with annotations. (See end of Document for details) [View outstanding changes](#)

— **Value ‘XY,Z’:** Calibri bold 22 pt, 100 % black.

11 **EER and COP values, rounded up to one decimal:**

— **Text:** Calibri regular 14 pt, capitals, 100 % black.

— **Value ‘X,Y’:** Calibri bold 22 pt, 100 % black.

12 **Hourly energy consumption in kWh/60min:**

— **Text ‘kWh/60min*’:** Calibri regular 14 pt, 100 % black.

— **Value ‘XY’:** Calibri bold 22 pt, 100 % black.

13 **Noise emissions:**

— **Border:** 2 pt – colour: cyan 100 % – round corners: 3,5 mm.

— **Value:** Calibri bold 22 pt, 100 % black.

— **Text:** Calibri regular 14 pt, 100 % black.

14 **Supplier’s name or trademark.**

15 **Supplier’s model identifier:**

The suppliers’ name or trade mark and model identifier should fit in a space of 82 × 10,5 mm.

16 **Reference period:**

— **Text:** Calibri bold 10 pt.

5.3. **Cooling-only single duct air conditioners classified in energy efficiency classes A+++ to D** **U.K.**

Changes to legislation: There are outstanding changes not yet made to Commission Delegated Regulation (EU) No 626/2011. Any changes that have already been made to the legislation appear in the content and are referenced with annotations. (See end of Document for details) View outstanding changes

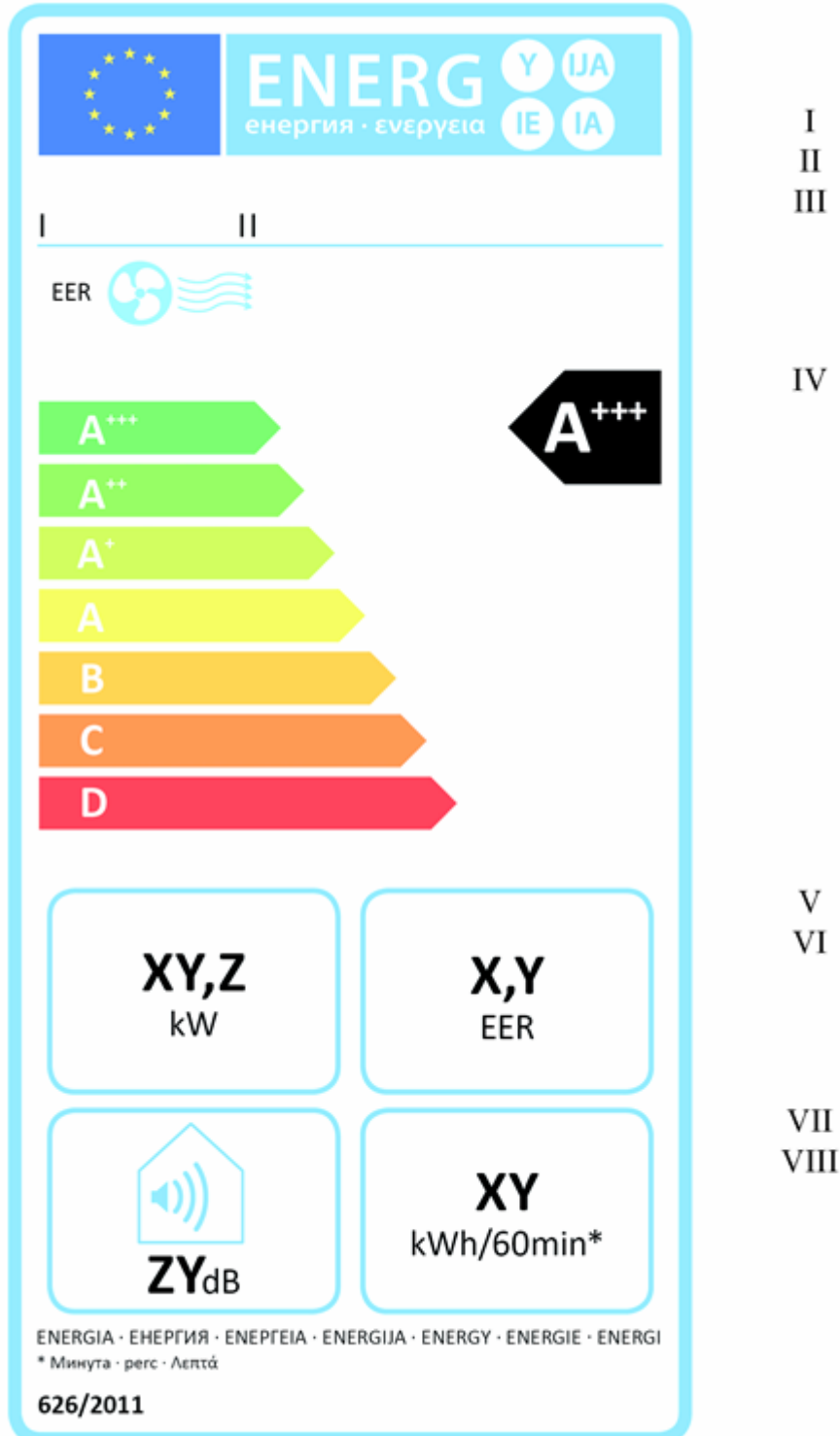

- (a) The following information shall be included in the label: **U.K.**
- I. supplier's name or trade mark;

Changes to legislation: There are outstanding changes not yet made to Commission Delegated Regulation (EU) No 626/2011. Any changes that have already been made to the legislation appear in the content and are referenced with annotations. (See end of Document for details) [View outstanding changes](#)

- II. supplier's model identifier;
- III. text 'EER', with a blue fan and air wave indication;
- IV. the energy efficiency; the head of the arrow containing the energy efficiency class of the appliance shall be placed at the same height as the head of the arrow of the relevant energy efficiency class;
- V. rated capacity for cooling in kW, rounded up to one decimal;
- VI. EER_{rated} , rounded up to one decimal;
- VII. [^{F1}hourly energy consumption in kWh per 60 minutes, rounded up to the nearest integer;]
- VIII. sound power level for indoor unit expressed in dB(A) re1 pW, rounded to the nearest integer.

All the requested values shall be determined in accordance with Annex VII.

- (b) The design of the label shall be in accordance with point 5.4. By way of derogation, where a model has been granted an 'EU eco-label' under Regulation (EC) No 66/2010, a copy of the EU eco-label may be added.

5.4. **Label Design** U.K.

Changes to legislation: There are outstanding changes not yet made to Commission Delegated Regulation (EU) No 626/2011. Any changes that have already been made to the legislation appear in the content and are referenced with annotations. (See end of Document for details) View outstanding changes

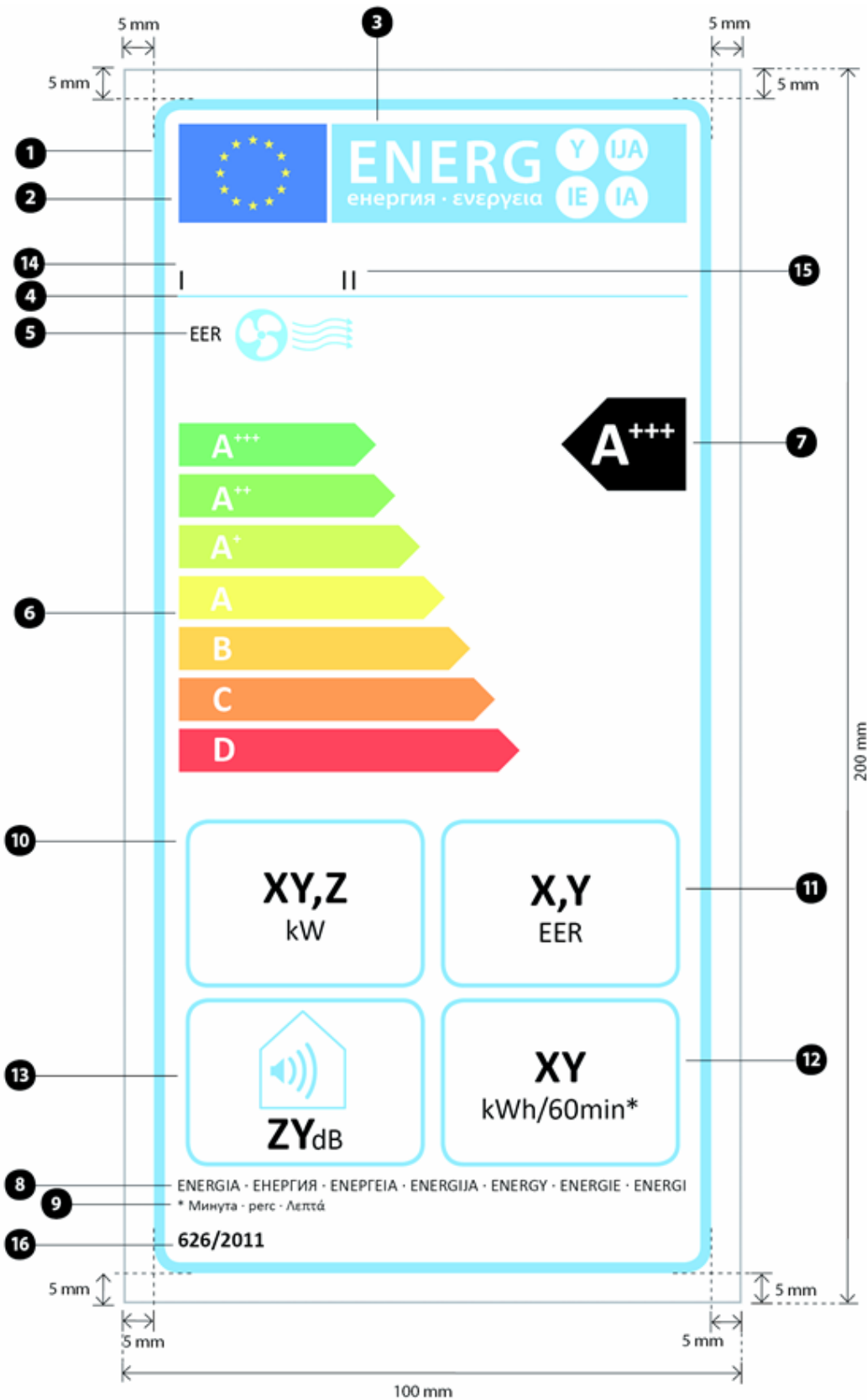

Changes to legislation: There are outstanding changes not yet made to Commission Delegated Regulation (EU) No 626/2011. Any changes that have already been made to the legislation appear in the content and are referenced with annotations. (See end of Document for details) View outstanding changes

Whereby:

- (i) The label shall be at least 100 mm wide and 200 mm high. Where the label is printed in a larger format, its content shall nevertheless remain proportionate to the specifications above.
- (ii) The background shall be white.
- (iii) Colours shall be CMYK — cyan, magenta, yellow and black, following this example: 00-70-X-00: 0 % cyan, 70 % magenta, 100 % yellow, 0 % black.
- (iv) The label shall fulfil all of the following requirements (numbers refer to the figure above):
 - 1 **EU label border:** stroke: 5 pt – colour: cyan 100 % – round corners: 3,5 mm.
 - 2 **EU logo:** Colours: X-80-00-00 and 00-00-X-00.
 - 3 **Energy label:** Colour: X-00-00-00.
Pictogram as depicted: EU logo + energy label: width: 82 mm, height: 16 mm.
 - 4 **Sub-logos border:** 1 pt – colour: cyan 100 % – length: 92,5 mm.
 - 5 **EER indication:**
Text: Calibri regular 10 pt, capitals, 100 % black.
 - 6 **A-G scale:**
 - **Arrow:** height: 7 mm, gap: 1,3 mm – colours:
Highest class: X-00-X-00,
Second class: 70-00-X-00,
Third class: 30-00-X-00,
Fourth class: 00-00-X-00,
Fifth class: 00-30-X-00,
Sixth class: 00-70-X-00,
Last class(es): 00-X-X-00.
 - | | |
|--------------|--------------------------------------|
| Text: | Calibri bold 18 pt, capitals, white; |
| | Calibri bold 7 pt, white. |
 - 7 **Energy efficiency class:**
 - **Arrow:** Width: 20 mm, height: 15 mm, 100 % black;
 - | | |
|--------------|--------------------------------------|
| Text: | Calibri bold 30 pt, capitals, white; |
| | Calibri bold 14 pt, capitals, white. |
 - 8 **Energy:**
 - **Text:** Calibri regular 8 pt, capitals, 100 % black.
 - 9 **‘Minutes’-translation:**

Changes to legislation: There are outstanding changes not yet made to Commission Delegated Regulation (EU) No 626/2011. Any changes that have already been made to the legislation appear in the content and are referenced with annotations. (See end of Document for details) View outstanding changes

— **Text:** Calibri regular 7 pt, 100 % black.

10 **Rated capacity in kW:**

- **Text ‘kW’:** Calibri regular 14 pt, 100 % black.
- **Value ‘XY,Z’:** Calibri bold 22 pt, 100 % black.

11 **EER value, rounded up to one decimal:**

- **Text ‘EER’:** Calibri regular 14 pt, capitals, 100 % black.
- **Value ‘X,Y’:** Calibri bold 22 pt, 100 % black.

12 **Hourly energy consumption in kWh/60min:**

- **Text ‘kWh/60min*’:** Calibri regular 14 pt, 100 % black.
- **Value ‘XY’:** Calibri bold 22 pt, 100 % black.

13 **Noise emissions:**

- **Border:** 2 pt – colour: 100 % cyan – round corners: 3,5 mm.
- **Value:** Calibri bold 22 pt, 100 % black.
- **Text:** Calibri regular 14 pt, 100 % black.

14 **Supplier’s name or trademark.**

15 **Supplier’s model identifier:**

The suppliers’ name or trade mark and model identifier should fit in a space of 82 × 10,5 mm.

16 **Reference period:**

- **Text:** Calibri bold 10 pt.

5.5. **Heating-only single duct air conditioners classified in energy efficiency classes A+++ to D** **U.K.**

Changes to legislation: There are outstanding changes not yet made to Commission Delegated Regulation (EU) No 626/2011. Any changes that have already been made to the legislation appear in the content and are referenced with annotations. (See end of Document for details) View outstanding changes

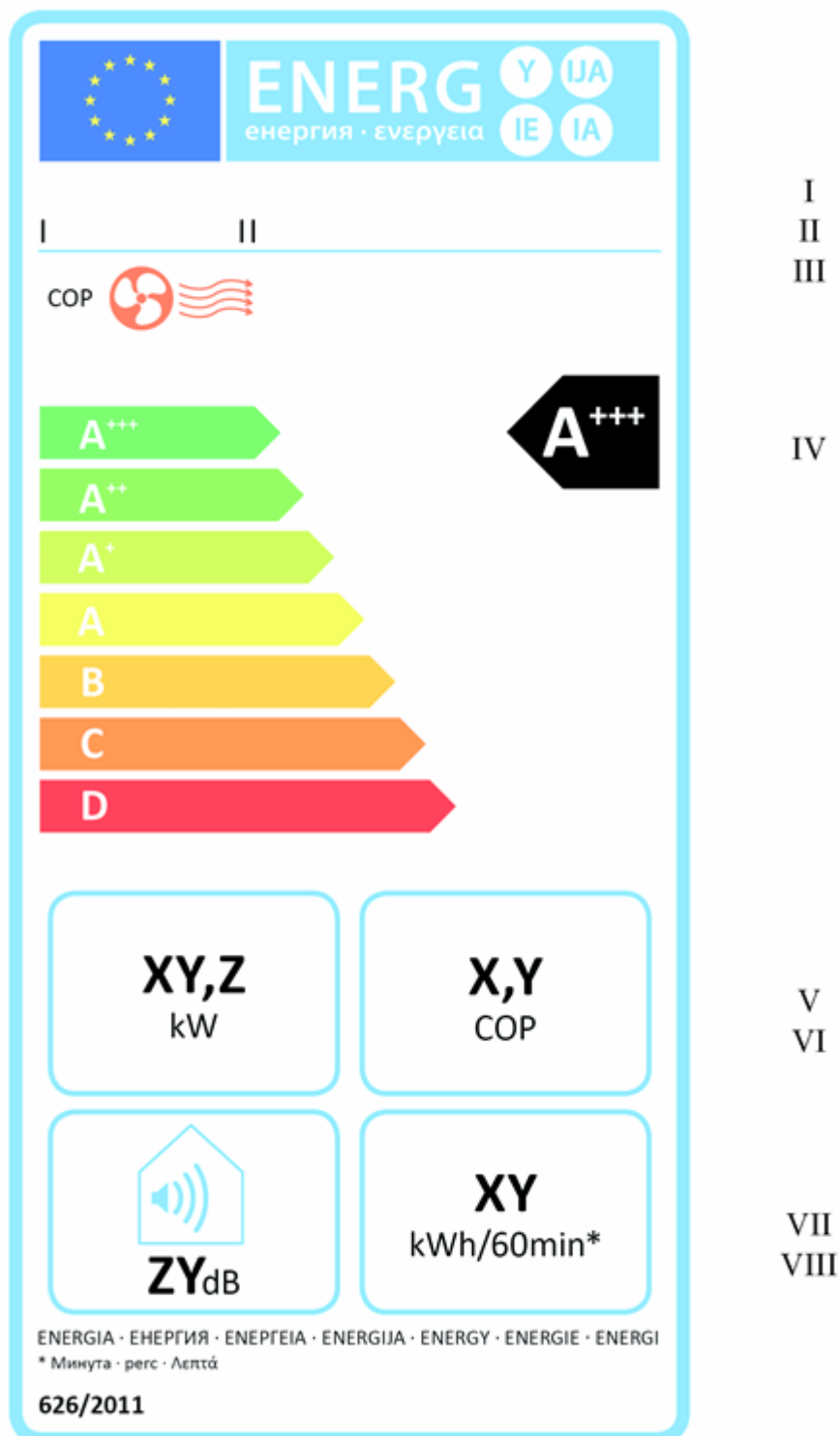

(a) The following information shall be included in the label: U.K.

I. supplier's name or trade mark;

Changes to legislation: There are outstanding changes not yet made to Commission Delegated Regulation (EU) No 626/2011. Any changes that have already been made to the legislation appear in the content and are referenced with annotations. (See end of Document for details) View outstanding changes

- II. supplier's model identifier;
- III. text 'COP' with red fan and air wave indication;
- IV. the energy efficiency; the head of the arrow containing the energy efficiency class of the appliance shall be placed at the same height as the head of the arrow of the relevant energy efficiency class;
- V. rated capacity for heating in kW, rounded up to one decimal;
- VI. COP_{rated} , rounded up to one decimal;
- VII. [^{F1}hourly energy consumption in kWh per 60 minutes, rounded up to the nearest integer;]
- VIII. sound power level for indoor unit expressed in dB(A) re1 pW, rounded to the nearest integer.

All the requested values shall be determined in accordance with Annex VII.

- (b) The design of the label shall be in accordance with point 5.6. By way of derogation, where a model has been granted an 'EU eco-label' under Regulation (EC) No 66/2010, a copy of the EU eco-label may be added.

5.6. **Label Design** U.K.

Changes to legislation: There are outstanding changes not yet made to Commission Delegated Regulation (EU) No 626/2011. Any changes that have already been made to the legislation appear in the content and are referenced with annotations. (See end of Document for details) View outstanding changes

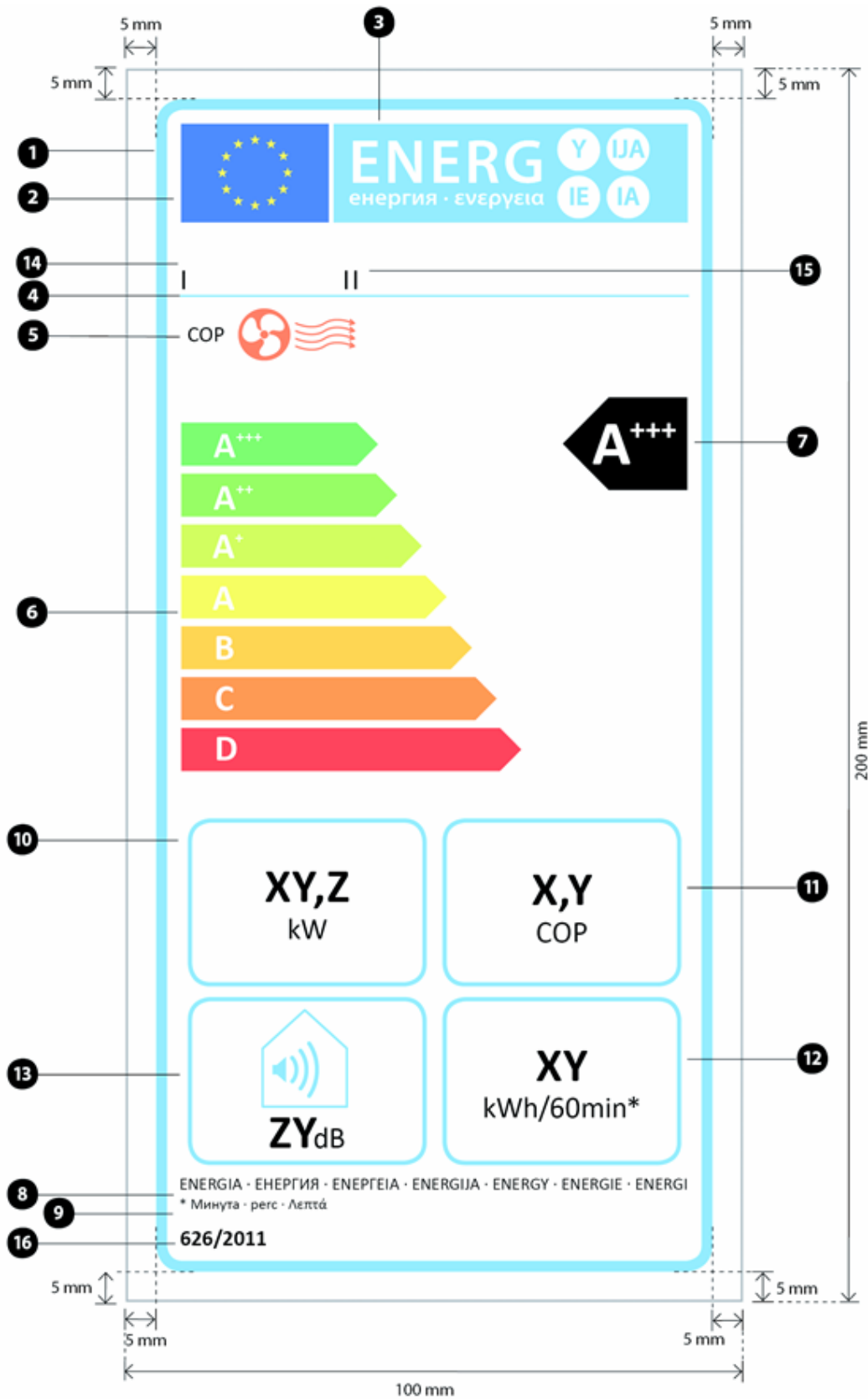

Changes to legislation: There are outstanding changes not yet made to Commission Delegated Regulation (EU) No 626/2011. Any changes that have already been made to the legislation appear in the content and are referenced with annotations. (See end of Document for details) View outstanding changes

Whereby:

- (i) The label shall be at least 100 mm wide and 200 mm high. Where the label is printed in a larger format, its content shall nevertheless remain proportionate to the specifications above.
- (ii) The background shall be white.
- (iii) Colours shall be CMYK — cyan, magenta, yellow and black, following this example: 00-70-X-00: 0 % cyan, 70 % magenta, 100 % yellow, 0 % black.
- (iv) The label shall fulfil all of the following requirements (numbers refer to the figure above):
- 1 **EU label border:** stroke: 5 pt – colour: cyan 100 % – round corners: 3,5 mm.
 - 2 **EU logo:** Colours: X-80-00-00 and 00-00-X-00.
 - 3 **Energy label:** Colour: X-00-00-00.
Pictogram as depicted: EU logo + energy label: width: 82 mm, height: 16 mm.
 - 4 **Sub-logos border:** 1 pt – colour: cyan 100 % – length: 92,5 mm.
 - 5 **COP indication:**
Text: Calibri regular 10 pt, capitals, 100 % black
 - 6 **A-G scale:**
 - **Arrow:** height: 7 mm, gap: 1,3 mm – colours:
Highest class: X-00-X-00,
Second class: 70-00-X-00,
Third class: 30-00-X-00,
Fourth class: 00-00-X-00,
Fifth class: 00-30-X-00,
Sixth class: 00-70-X-00,
Last class(es): 00-X-X-00.
 - | | |
|--------------|--------------------------------------|
| Text: | Calibri bold 18 pt, capitals, white; |
| | Calibri bold 7 pt, white. |
 - 7 **Energy efficiency class:**
 - **Arrow:** Width: 20 mm, height: 15 mm, 100 % black;
 - | | |
|--------------|--------------------------------------|
| Text: | Calibri bold 30 pt, capitals, white; |
| | Calibri bold 14 pt, capitals, white. |
 - 8 **Energy:**
 - **Text:** Calibri regular 8 pt, capitals, 100 % black.
 - 9 **‘Minutes’-translation:**

Changes to legislation: There are outstanding changes not yet made to Commission Delegated Regulation (EU) No 626/2011. Any changes that have already been made to the legislation appear in the content and are referenced with annotations. (See end of Document for details) [View outstanding changes](#)

- **Text:** Calibri regular 7 pt, 100 % black.
- 10 **Rated capacity in kW:**
 - **Text ‘kW’:** Calibri regular 14 pt, 100 % black.
 - **Value ‘XY,Z’:** Calibri bold 22 pt, 100 % black.
- 11 **COP value, rounded up to one decimal:**
 - **Text ‘COP’:** Calibri regular 14 pt, capitals, 100 % black.
 - **Value ‘X,Y’:** Calibri bold 22 pt, 100 % black.
- 12 **Hourly energy consumption in kWh/60 minutes:**
 - **Text ‘kWh/60min*’:** Calibri regular 14 pt, 100 % black.
 - **Value ‘XY’:** Calibri bold 22 pt, 100 % black.
- 13 **Noise emissions:**
 - **Border:** 2 pt – colour: cyan 100 % – round corners: 3,5 mm.
 - **Value:** Calibri bold 22 pt, 100 % black.
 - **Text:** Calibri regular 14 pt, 100 % black.
- 14 **Supplier’s name or trademark.**
- 15 **Supplier’s model identifier:**

The suppliers’ name or trade mark and model identifier should fit in a space of 82 × 10,5 mm.
- 16 **Reference period:**
 - **Text:** Calibri bold 10 pt.

Changes to legislation: *There are outstanding changes not yet made to Commission Delegated Regulation (EU) No 626/2011. Any changes that have already been made to the legislation appear in the content and are referenced with annotations. (See end of Document for details) [View outstanding changes](#)*

(1) [OJ L 27, 30.1.2010, p. 1.](#)

Changes to legislation:

There are outstanding changes not yet made to Commission Delegated Regulation (EU) No 626/2011. Any changes that have already been made to the legislation appear in the content and are referenced with annotations.

[View outstanding changes](#)

Changes and effects yet to be applied to the whole legislation item and associated provisions

- Signature words omitted by [S.I. 2019/539 Sch. 5 para. 5\(5\)](#)
- Annex 1(8) substituted by [S.I. 2019/539 Sch. 5 para. 5\(6\)](#)
- Annex 5(c) word substituted by [S.I. 2019/539 Sch. 5 para. 5\(9\)](#)
- Annex 3 para. 1.4 image substituted by [S.I. 2020/1528 Sch. 5 para. 6\(2\)](#)
- Annex 3 para. 1.5 image substituted by [S.I. 2020/1528 Sch. 5 para. 6\(3\)](#)
- Annex 3 para. 2.4 image substituted by [S.I. 2020/1528 Sch. 5 para. 6\(4\)](#)
- Annex 3 para. 2.5 image substituted by [S.I. 2020/1528 Sch. 5 para. 6\(5\)](#)
- Annex 3 para. 3.4 image substituted by [S.I. 2020/1528 Sch. 5 para. 6\(6\)](#)
- Annex 3 para. 3.5 image substituted by [S.I. 2020/1528 Sch. 5 para. 6\(7\)](#)
- Annex 3 para. 4.1 image substituted by [S.I. 2020/1528 Sch. 5 para. 6\(8\)](#)
- Annex 3 para. 4.2 image substituted by [S.I. 2020/1528 Sch. 5 para. 6\(9\)](#)
- Annex 3 para. 4.3 image substituted by [S.I. 2020/1528 Sch. 5 para. 6\(10\)](#)
- Annex 3 para. 4.4 image substituted by [S.I. 2020/1528 Sch. 5 para. 6\(11\)](#)
- Annex 3 para. 4.5 image substituted by [S.I. 2020/1528 Sch. 5 para. 6\(12\)](#)
- Annex 3 para. 4.6 image substituted by [S.I. 2020/1528 Sch. 5 para. 6\(13\)](#)
- Annex 3 para. 5.1 image substituted by [S.I. 2020/1528 Sch. 5 para. 6\(14\)](#)
- Annex 3 para. 5.2 image substituted by [S.I. 2020/1528 Sch. 5 para. 6\(15\)](#)
- Annex 3 para. 5.3 image substituted by [S.I. 2020/1528 Sch. 5 para. 6\(16\)](#)
- Annex 3 para. 5.4 image substituted by [S.I. 2020/1528 Sch. 5 para. 6\(17\)](#)
- Annex 3 para. 5.5 image substituted by [S.I. 2020/1528 Sch. 5 para. 6\(18\)](#)
- Annex 3 para. 5.6 image substituted by [S.I. 2020/1528 Sch. 5 para. 6\(19\)](#)
- Annex 3 s.0001para. 1.1 words inserted by [S.I. 2019/539 Sch. 5 para. 5\(7\)\(a\)](#)
- Annex 3 s.0002para. 2.1 words inserted by [S.I. 2019/539 Sch. 5 para. 5\(7\)\(b\)](#)
- Annex 3 s.0003para. 3.1 words inserted by [S.I. 2019/539 Sch. 5 para. 5\(7\)\(c\)](#)
- Annex 3 s.0004para. 4.1 words inserted by [S.I. 2019/539 Sch. 5 para. 5\(7\)\(d\)](#)
- Annex 3 s.0004para. 4.3 words inserted by [S.I. 2019/539 Sch. 5 para. 5\(7\)\(d\)](#)
- Annex 3 s.0004para. 4.5 words inserted by [S.I. 2019/539 Sch. 5 para. 5\(7\)\(d\)](#)
- Annex 3 s.0005para. 5.1 words inserted by [S.I. 2019/539 Sch. 5 para. 5\(7\)\(e\)](#)
- Annex 3 s.0005para. 5.3 words inserted by [S.I. 2019/539 Sch. 5 para. 5\(7\)\(e\)](#)
- Annex 3 s.0005para. 5.5 words inserted by [S.I. 2019/539 Sch. 5 para. 5\(7\)\(e\)](#)
- Annex 3 para. 1.5(iv) words substituted by [S.I. 2020/1528 Sch. 5 para. 6\(20\)\(a\)](#)
- Annex 3 para. 2.5(iv) words substituted by [S.I. 2020/1528 Sch. 5 para. 6\(20\)\(a\)](#)
- Annex 3 para. 3.5(iv) words substituted by [S.I. 2020/1528 Sch. 5 para. 6\(20\)\(a\)](#)
- Annex 3 para. 4.2(iv) words substituted by [S.I. 2020/1528 Sch. 5 para. 6\(20\)\(a\)](#)
- Annex 3 para. 4.4(iv) words substituted by [S.I. 2020/1528 Sch. 5 para. 6\(20\)\(a\)](#)
- Annex 3 para. 4.6(iv) words substituted by [S.I. 2020/1528 Sch. 5 para. 6\(20\)\(a\)](#)
- Annex 3 para. 5.2(iv) words substituted by [S.I. 2020/1528 Sch. 5 para. 6\(20\)\(a\)](#)
- Annex 3 para. 5.4(iv) words substituted by [S.I. 2020/1528 Sch. 5 para. 6\(20\)\(a\)](#)
- Annex 3 para. 5.6(iv) words substituted by [S.I. 2020/1528 Sch. 5 para. 6\(20\)\(a\)](#)
- Annex 3 para. 1.5(iv) words substituted by [S.I. 2020/1528 Sch. 5 para. 6\(20\)\(b\)](#)
- Annex 3 para. 2.5(iv) words substituted by [S.I. 2020/1528 Sch. 5 para. 6\(20\)\(b\)](#)
- Annex 3 para. 3.5(iv) words substituted by [S.I. 2020/1528 Sch. 5 para. 6\(20\)\(b\)](#)
- Annex 3 para. 4.2(iv) words substituted by [S.I. 2020/1528 Sch. 5 para. 6\(20\)\(b\)](#)
- Annex 3 para. 4.4(iv) words substituted by [S.I. 2020/1528 Sch. 5 para. 6\(20\)\(b\)](#)
- Annex 3 para. 4.6(iv) words substituted by [S.I. 2020/1528 Sch. 5 para. 6\(20\)\(b\)](#)
- Annex 3 para. 5.2(iv) words substituted by [S.I. 2020/1528 Sch. 5 para. 6\(20\)\(b\)](#)
- Annex 3 para. 5.4(iv) words substituted by [S.I. 2020/1528 Sch. 5 para. 6\(20\)\(b\)](#)
- Annex 3 para. 5.6(iv) words substituted by [S.I. 2020/1528 Sch. 5 para. 6\(20\)\(b\)](#)

- Annex 3 para. 1.1 words substituted in earlier amending provision S.I. 2019/539, Sch. 5 para. 5(7)(a) by [S.I. 2020/1528 reg. 4](#)
- Annex 3 para. 2.1 words substituted in earlier amending provision S.I. 2019/539, Sch. 5 para. 5(7)(b) by [S.I. 2020/1528 reg. 4](#)
- Annex 3 para. 3.1 words substituted in earlier amending provision S.I. 2019/539, Sch. 5 para. 5(7)(c) by [S.I. 2020/1528 reg. 4](#)
- Annex 3 para. 4.1 words substituted in earlier amending provision S.I. 2019/539, Sch. 5 para. 5(7)(d) by [S.I. 2020/1528 reg. 4](#)
- Annex 3 para. 4.3 words substituted in earlier amending provision S.I. 2019/539, Sch. 5 para. 5(7)(d) by [S.I. 2020/1528 reg. 4](#)
- Annex 3 para. 4.5 words substituted in earlier amending provision S.I. 2019/539, Sch. 5 para. 5(7)(d) by [S.I. 2020/1528 reg. 4](#)
- Annex 3 para. 5.1 words substituted in earlier amending provision S.I. 2019/539, Sch. 5 para. 5(7)(e) by [S.I. 2020/1528 reg. 4](#)
- Annex 3 para. 5.3 words substituted in earlier amending provision S.I. 2019/539, Sch. 5 para. 5(7)(e) by [S.I. 2020/1528 reg. 4](#)
- Annex 3 para. 5.5 words substituted in earlier amending provision S.I. 2019/539, Sch. 5 para. 5(7)(e) by [S.I. 2020/1528 reg. 4](#)
- Annex 7 para. 1 words substituted by [S.I. 2019/539 Sch. 5 para. 5\(10\)](#)
- Annex 8(7) omitted by [S.I. 2019/539 Sch. 5 para. 5\(11\)\(b\)](#)
- Annex 4 para. 1(c) substituted by [S.I. 2019/539 Sch. 5 para. 5\(8\)](#)
- Annex 4 para. 1(c) words substituted in earlier amending provision S.I. 2019/539, Sch. 5 para. 5(8) by [S.I. 2020/1528 reg. 4](#)
- Art. 3(1)(c) words substituted by [S.I. 2019/539 Sch. 5 para. 5\(2\)](#)
- Art. 3(1)(c) words substituted in earlier amending provision S.I. 2019/539, Sch. 5 para. 5(2) by [S.I. 2020/1528 reg. 6\(1\)reg. 6\(2\)\(c\)\(v\)](#)