

This document is meant purely as a documentation tool and the institutions do not assume any liability for its contents

► **B** **DIRECTIVE 2003/97/EC OF THE EUROPEAN PARLIAMENT AND OF THE COUNCIL**
of 10 November 2003

on the approximation of the laws of the Member States relating to the type-approval of devices for indirect vision and of vehicles equipped with these devices, amending Directive 70/156/EEC and repealing Directive 71/127/EEC

(Text with EEA relevance)

(OJ L 25, 29.1.2004, p. 1)

Amended by:

		Official Journal		
		No	page	date
► <u>M1</u>	Commission Directive 2005/27/EC of 29 March 2005	L 81	44	30.3.2005
► <u>M2</u>	Council Directive 2006/96/EC of 20 November 2006	L 363	81	20.12.2006



**DIRECTIVE 2003/97/EC OF THE EUROPEAN PARLIAMENT
AND OF THE COUNCIL**

of 10 November 2003

**on the approximation of the laws of the Member States relating to
the type-approval of devices for indirect vision and of vehicles
equipped with these devices, amending Directive 70/156/EEC and
repealing Directive 71/127/EEC**

(Text with EEA relevance)

THE EUROPEAN PARLIAMENT AND THE COUNCIL OF THE
EUROPEAN UNION,

Having regard to the Treaty establishing the European Community, and
in particular Article 95 thereof,

Having regard to the proposal from the Commission ⁽¹⁾,

Having regard to the opinion of the European Economic and Social
Committee ⁽²⁾,

Acting in accordance with the procedure laid down in Article 251 of the
Treaty ⁽³⁾,

Whereas:

- (1) Council Directive 71/127/EEC of 1 March 1971 on the approximation of the laws of the Member States relating to the rear-view mirrors of motor vehicles ⁽⁴⁾ was adopted as one of the separate directives of the EC type-approval procedure which was established by Council Directive 70/156/EEC of 6 February 1970 on the approximation of the laws of the Member States relating to the type-approval of motor vehicles and their trailers ⁽⁵⁾. Consequently, the provisions laid down in Directive 70/156/EEC relating to vehicle systems, components and separate technical units apply to Directive 71/127/EEC.
- (2) Existing provisions, in particular in the case of categories N₂, N₃, M₂ and M₃ have proved inadequate as regards the exterior field of vision to the side, front and rear of the vehicle. In order to remedy this shortcoming, it is necessary to require an extension of the field of vision.
- (3) In the light of the experience gained and the present state of the art, it is now possible to amplify certain requirements of Directive 71/127/EEC with a view to improving road safety and to permit the use of mirrors to be supplemented by other technologies.
- (4) Taking into account the nature and the number of changes necessary to the requirements in force today, it is advisable to repeal and replace Directive 71/127/EEC by this Directive. Since the type-approval and the conformity of production procedures are provided for in Directive 70/156/EEC, it is not necessary to repeat them in this Directive.

⁽¹⁾ OJ C 126 E, 28.5.2002, p. 225.

⁽²⁾ OJ C 149, 21.6.2002, p. 5.

⁽³⁾ Opinion of the European Parliament of 9 April 2002 (OJ C 127 E, 29.5.2003, p. 25, Council common position of 8 April 2003 (OJ C 214 E, 9.9.2003, p. 7), position of the European Parliament of 1 July 2003 (not yet published in the Official Journal) and Council decision of 20 October 2003.

⁽⁴⁾ OJ L 68, 22.3.1971, p. 1. Directive as last amended by the 1994 Act of Accession.

⁽⁵⁾ OJ L 42, 23.2.1970, p. 1. Directive as last amended by Regulation (EC) No 807/2003 (OJ L 122, 16.5.2003, p. 36).

▼B

- (5) The Annexes to Directive 70/156/EEC should be amended accordingly,

HAVE ADOPTED THIS DIRECTIVE:

Article 1

The aim of this Directive is to harmonise rules relating to the type-approval of devices for indirect vision and of vehicles equipped with these devices.

These rules are contained in the Annexes to this Directive.

For the purpose of this Directive ‘vehicle’ means any motor vehicle as defined in Section A of Annex II to Directive 70/156/EEC.

Article 2

1. With effect from 26 January 2005, Member States shall not, on grounds relating to devices for indirect vision,

- refuse to grant EC type-approval or national type-approval of a vehicle or a device for indirect vision,
- prohibit the sale, registration or entry into service of vehicles or devices for indirect vision,

if the vehicles or devices for indirect vision comply with the requirements of this Directive.

2. With effect from 26 January 2006, Member States shall refuse to grant EC type-approval for any new type of vehicle on grounds relating to the device for indirect vision or for any new type of device for indirect vision, if the requirements of this Directive are not fulfilled.

However, this date shall be postponed by 12 months as regards the requirements concerning a class VI front mirror as a component and its installation on vehicles.

3. With effect from 26 January 2006, Member States shall prohibit the national type-approval for any new type of vehicle on grounds relating to the device for indirect vision if the requirements of this Directive are not fulfilled.

However this date shall be postponed by 12 months as regards the requirements concerning a class VI front mirror as a component and its installation on vehicles.

4. With effect from 26 January 2010 for vehicles of categories M₁ and N₁, and with effect from 26 January 2007 for all vehicles of other categories, Member States:

- shall consider certificates of conformity which accompany new vehicles in accordance with the provisions of Directive 70/156/EEC to be no longer valid for the purposes of Article 7(1) of that Directive,
- shall prohibit the sale, registration or entry into service of vehicles,

on grounds relating to the device for indirect vision if the vehicles do not comply with the requirements of this Directive.

5. With effect from 26 January 2010 for vehicles of categories M₁ and N₁, and with effect from 26 January 2007, for all vehicles of other categories, the requirements of this Directive relating to the device for indirect vision as a component shall apply for the purposes of Article 7 (2) of Directive 70/156/EEC.

6. Notwithstanding paragraphs 2 and 5, for the purposes of replacement parts, Member States shall continue to grant EC type-approval

▼B

and to permit the sale and entry into service of components or separate technical units intended for use on vehicle types which have been approved before 26 January 2007, pursuant to Directive 71/127/EEC and, where applicable, subsequent extensions to those approvals.

7. Notwithstanding paragraph 3, Member States may continue to grant national type-approval for any new type of articulated vehicle of category M₂ and M₃, class I, as defined in Annex I, point 2.1.1.1 to Directive 2001/85/EC ⁽¹⁾, composed of at least three articulated rigid parts, which do not comply with the provisions of this Directive, provided that the requirements for the driver's field of vision are respected as referred in Annex III, point 5 to this Directive.

8. The provisions laid down in this Directive shall also contribute to establishing a high level of protection in the context of the international harmonisation of legislation in this area. Therefore, as soon as possible after the adoption of this Directive, the Commission shall submit a proposal to the United Nations Economic Commission for Europe with the aim of aligning the provisions of UNECE Regulation 46 with the provisions of this Directive.

Article 3

By 26 January 2010, the Commission shall carry out a detailed study to ascertain whether the amendments introduced by this Directive are having a positive effect on road safety, in particular as regards pedestrians, cyclists and other vulnerable road users. On the basis of those findings, the Commission shall, if necessary, propose additional legislative measures for further improvement of the field of indirect vision.

Article 4

Directive 70/156/EEC is hereby amended as follows:

1. in Annex I, point 9.9 is replaced by the following:

- ‘9.9. Devices for indirect vision
- 9.9.1. Mirrors (state for each mirror):
- 9.9.1.1. Make:
- 9.9.1.2. EC type-approval mark:
- 9.9.1.3. Variant:
- 9.9.1.4. Drawing(s) for the identification of the mirror showing the position of the mirror relative to the vehicle structure: ...
.....
- 9.9.1.5. Details of the method of attachment including that part of the vehicle structure to which it is attached:
- 9.9.1.6. Optional equipment which may affect the rearward field of vision:
- 9.9.1.7. A brief description of the electronic components (if any) of the adjustment system:
- 9.9.2. Devices for indirect vision other than mirrors:
- 9.9.2.1. Type and characteristics (such as a complete description of the device):

⁽¹⁾ Directive 2001/85/EC of the European Parliament and of the Council of 20 November 2001 relating to special priorities for vehicles used for the carriage of passengers comprising more than eight seats in addition to the driver's seat (OJ L 42, 13.2.2002, p. 1).

▼B

9.9.2.1.1. In the case of a camera-monitor device, the detection distance (mm), contrast, luminance range, glare correction, display performance (black and white/colour), image repetition frequency, luminance reach of the monitor:

.....

9.9.2.1.2. Sufficiently detailed drawings to identify the complete device, including installation instructions; the position for the EC type-approval mark has to be indicated on the drawings:

2. in Annex III, point 9.9 is replaced by the following:

‘9.9. Devices for indirect vision

9.9.1. Mirrors (state for each mirror):

9.9.1.1. Make:

9.9.1.2. EC type-approval mark:

9.9.1.3. Variant:

9.9.1.4. Drawing(s) for the identification of the mirror showing the position of the mirror relative to the vehicle structure: ...

9.9.1.5. Details of the method of attachment including that part of the vehicle structure to which it is attached:

9.9.1.6. Optional equipment which may affect the rearward field of vision: ...

9.9.1.7. A brief description of the electronic components (if any) of the adjustment system:

9.9.2. Devices for indirect vision other than mirrors:

9.9.2.1. Type and characteristics (such as a complete description of the device):

9.9.2.1.1. In the case of camera-monitor device, the detection distance (mm), contrast, luminance range, glare correction, display performance (black and white/colour), image repetition frequency, luminance reach of the monitor:

.....

9.9.2.1.2. Sufficiently detailed drawings to identify the complete device, including installation instructions; the position for the EC type-approval mark has to be indicated on the drawings:

3. Annex IV is hereby amended as follows:

— Part I, point 8 of the table shall be replaced by the following:

‘Subject	Directive number	Official Journal reference	Applicability											
			M ₁	M ₂	M ₃	N ₁	N ₂	N ₃	O ₁	O ₂	O ₃	O ₄		
.....														
8. Indirect vision devices	2003/97/EC	L 25 of 29.1.2004	X	X	X	X	X	X						

— in point 8 of Part I, the term ‘rear-view mirrors’ shall be replaced by ‘devices for indirect vision’,

— in point 8 of Part II, the term ‘rear-view mirrors’ shall be replaced by ‘devices for indirect vision’;

4. in point 8 of Appendices 1 and 2 to Annex XI, the term ‘rear-view mirrors’ shall be replaced by ‘devices for indirect vision’.

▼B*Article 5*

1. Member States shall bring into force the laws, regulations and administrative provisions necessary to comply with this Directive before 24 January 2005. They shall forthwith inform the Commission thereof.

When Member States adopt these measures, they shall contain a reference to this Directive or be accompanied by such reference on the occasion of their official publication. The methods of making such reference shall be laid down by the Member States.

2. Member States shall communicate to the Commission the text of the main provisions of national law which they adopt in the field covered by this Directive.

Article 6

Directive 71/127/EEC shall be repealed with effect from 24 January 2010.

References to the repealed Directive shall be construed as being made to this Directive and shall be read in accordance with the correlation table set out in Annex IV.

Article 7

This Directive shall enter into force on the day of its publication in the *Official Journal of the European Union*.

Article 8

This Directive is addressed to the Member States.

▼B**LIST OF ANNEXES**

- Annex I Definitions and administrative provisions for EC type-approval
- Appendix 1 Information document relating to EC type-approval of a device for indirect vision
 - Appendix 2 Model EC component type-approval certificate for a device for indirect vision
 - Appendix 3 Information document relating to EC type-approval of a vehicle
 - Appendix 4 Model EC type-approval certificate for a vehicle with regard to the installation of devices for indirect vision
 - Appendix 5 EC component type-approval mark
 - Appendix 6 Procedure for determining the H point and verifying the relative positions of the R and H points
- Annex II Design specifications and tests required for EC component type-approval of a device for indirect vision.
- Appendix 1 Procedure for determining the radius of curvature 'r' of the reflecting surface of a mirror
 - Appendix 2 Test method for determining reflectivity
- Annex III Requirements concerning the fitting of mirrors and other devices for indirect vision to vehicles.
- Appendix Calculation of the detection distance.
- Annex IV Correlation table provided for in Article 6.



ANNEX I

DEFINITIONS AND ADMINISTRATIVE PROVISIONS FOR EC TYPE-APPROVAL

1. DEFINITIONS

- 1.1. 'Devices for indirect vision' means devices to observe the traffic area adjacent to the vehicle which cannot be observed by direct vision. These can be conventional mirrors, camera-monitors or other devices able to present information about the indirect field of vision to the driver.
- 1.1.1. 'Mirror' means any device, excluding devices such as periscopes, intended to give a clear view to the rear, side or front of the vehicle within the fields of vision defined in point 5 of Annex III.
- 1.1.1.1. 'Interior mirror' means a device as defined in point 1.1, which can be fitted in the passenger compartment of a vehicle.
- 1.1.1.2. 'Exterior mirror' means a device as defined in point 1.1, which can be mounted on the external surface of a vehicle.
- 1.1.1.3. 'Surveillance mirror' means a mirror other than the ones defined in point 1.1.1, which can be fitted to the inside or outside of the vehicle in order to provide fields of vision other than those specified in point 5 of Annex III.
- 1.1.1.4. 'r' means the average of the radii of curvature measured over the reflecting surface, in accordance with the method described in point 2 of Appendix 1 to Annex II.
- 1.1.1.5. 'The principal radii of curvature at one point on the reflecting surface (r_i)' means the values obtained with the apparatus defined in Appendix 1 to Annex II, measured on the arc of the reflecting surface passing through the centre of this surface parallel to the segment b, as defined in point 2.2.1 of Annex II and on the arc perpendicular to this segment.
- 1.1.1.6. 'The radius of curvature at one point on the reflecting surface (r_p)' means the arithmetical average of the principal radii of curvature r_i and r'_i , i.e.:

$$r_p = \frac{r_i + r'_i}{2}$$

- 1.1.1.7. 'Spherical surface' means a surface which has a constant and equal radius in all directions.
- 1.1.1.8. 'Aspherical surface' means a surface which has only in one plane a constant radius.
- 1.1.1.9. 'Aspherical mirror' means a mirror composed of a spherical and an aspherical part, in which the transition of the reflecting surface from the spherical to the aspherical part has to be marked. The curvature of the main axis of the mirror is defined in the x/y coordinate system defined by the radius of the spherical primary calotte with:

$$y = R - \sqrt{(R^2 - x^2)} + k(x - a)^3$$

R: nominal radius in the spherical part

k: constant for the change of curvature

a: constant for the spherical size of the spherical primary calotte

- 1.1.1.10. 'Centre of the reflecting surface' means the centre of the visible area of the reflecting surface.

▼ B

- 1.1.1.11. 'The radius of curvature of the constituent parts of the mirror' means the radius 'c' of the arc of the circle which most closely approximates to the curved form of the part in question.
- 1.1.1.12. 'The driver's ocular points' means two points 65 mm apart and 635 mm vertically above point R of the driver's seat as defined in Appendix 6 to this Annex. ► **M1** In the case of a seat with fixed seat-back angle, the location of the ocular points shall be adjusted in accordance with the provisions of Appendix 7 to this Annex. ◀ The straight line joining these points runs perpendicular to the vertical longitudinal median plane of the vehicle. The centre of the segment joining the two ocular points is in a vertical longitudinal plane which must pass through the centre of the driver's designated seating position, as specified by the vehicle manufacturer.
- 1.1.1.13. 'Ambinocular vision' means the total field of vision obtained by the superimposition of the monocular fields of the right eye and the left eye (see *figure 1* below).

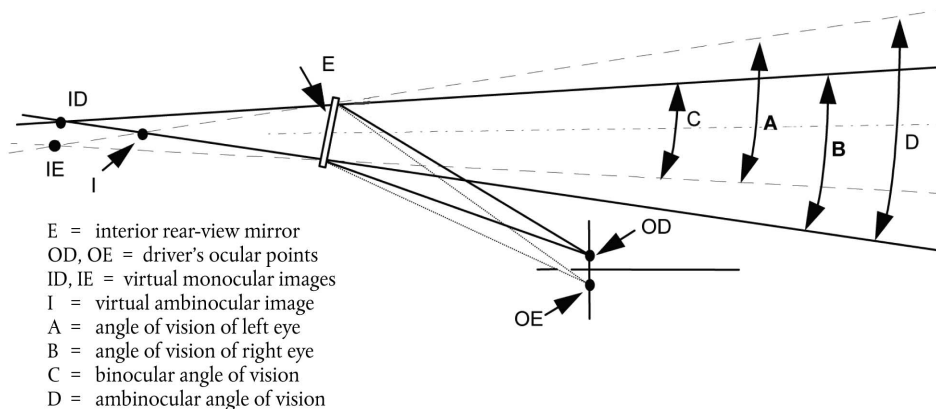

- 1.1.1.14. 'Class of mirror' means all devices having one or more common characteristics or functions. They are classified as follows:
- Class I: 'Interior rear-view mirror', giving the field of vision defined in point 5.1 of Annex III;
 - Class II and III: 'Main exterior rear-view mirror', giving the fields of vision defined in points 5.2 and 5.3 of Annex III;
 - Class IV: 'Wide-angle exterior mirror', giving the field of vision defined in point 5.4 of Annex III;
 - Class V: 'Close-proximity exterior mirror', giving the field of vision defined in point 5.5 of Annex III;
 - Class VI: 'Front mirror', giving the field of vision defined in point 5.6 of Annex III.
- 1.1.2. 'Camera-monitor device for indirect vision' means a device as defined in item 1.1, where the field of vision is obtained by means of a camera-monitor combination as defined in points 1.1.2.1 and 1.1.2.2.
- 1.1.2.1. 'Camera' means a device that renders an image of the outside world by means of a lens onto a light-sensitive electronic detector that then converts this image into a video signal.
- 1.1.2.2. 'Monitor' means a device that converts a video signal into images that are rendered into the visual spectrum.
- 1.1.2.3. 'Detection' means the ability to distinguish an object from its background/surroundings at certain distance.
- 1.1.2.4. 'Luminance' contrast means the brightness ratio between an object and its immediate background/surrounding that allows the object to be distinguished from its background/surroundings.
- 1.1.2.5. 'Resolution' means the smallest detail that can be discerned with a perceptual system, i.e. perceived as separate from the larger whole. The resolution of the human eye is indicated as 'visual acuity'.

▼B

- 1.1.2.6. 'Critical object' means a circular object with a diameter $D_0 = 0,8$ m ⁽¹⁾.
- 1.1.2.7. 'Critical perception' means the level of perception that the human eye is generally capable of achieving under various conditions. For traffic conditions the limiting value for a critical perception is eight arc-minutes of visual angle.
- 1.1.2.8. 'Field of vision' means the section of the tri-dimensional space in which a critical object can be observed and rendered by the device for indirect vision. This is based on the view on ground level offered by a device and might possibly be limited on the basis of the applicable maximum detection distance of the device.
- 1.1.2.9. 'Detection distance' means the distance measured at ground level from the viewing reference point to the extreme point at which a critical object just can be perceived (the limiting value for a critical perception just barely achieved).
- 1.1.2.10. 'Critical field of vision' means the area in which a critical object has to be detected by means of a device for indirect vision and that is defined by an angle and one or more detection distances.
- 1.1.2.11. 'Viewing reference point' means the point linked to the vehicle to which the prescribed field of vision is related. This point is the projection on the ground of the intersection of a vertical plane passing through the drivers's ocular points with a plane parallel to the median longitudinal plane of the vehicle situated 20 cm outside the vehicle.
- 1.1.2.12. 'Visual spectrum' means light with a wavelength within the range of the perceptual limits of the human eyes: 380-780 nm.
- 1.1.3. 'Other devices for indirect vision' means devices as defined in point 1.1, where the field of vision is not obtained by means of a mirror or a camera-monitor type device for indirect vision.
- 1.1.4. 'Type of device for indirect vision' means devices that do not differ on the following essential characteristics:
- design of the device inclusive, if pertinent, the attachment to the bodywork;
 - in case of mirrors the class, the shape, the dimensions and radius of curvature of the mirror's reflecting surface;
 - in case of camera-monitor devices the detection distance and the range of vision.
- 1.2. 'Vehicles of categories $M_1, M_2, M_3, N_1, N_2, N_3$ ' means those defined in Annex II, Part A to Directive 70/156/EEC.
- 1.2.1. 'Type of vehicle as regards indirect vision' means motor vehicles which are identical in respect of the following basic features:
- 1.2.1.1. Type of device for indirect vision
- 1.2.1.2. The bodywork features which reduce the field of vision;
- 1.2.1.3. The coordinates of point R;
- 1.2.1.4. The prescribed positions, and type-approval markings of compulsory and (if fitted) optional devices for indirect vision.
2. APPLICATION FOR EC COMPONENT TYPE-APPROVAL OF A DEVICE FOR INDIRECT VISION
- 2.1. The application for EC component type-approval for a type of device for indirect vision shall be made by the manufacturer.

⁽¹⁾ A system for indirect vision is intended to detect relevant road users. The relevancy of a road user is defined by his or her position and (potential) speed. More or less in proportion with the speed of the pedestrian/cyclist/moped driver, the dimensions of these road users increase as well. For detection purposes a moped driver ($D = 0,8$) at 40 m distance would be equal to a pedestrian ($D = 0,5$) at a distance of 25 m. Considering the speeds, the moped driver would be selected as the criterion for the detection size; for that reason an object with a size of 0,8 m shall be used for determining the detection performance.

▼B

- 2.2. The model information document is reproduced in Appendix 1 to this Annex.
- 2.3. For each type of device for indirect vision the application shall be accompanied by:
 - 2.3.1. In case of mirrors, four samples: three for use in the tests and one to be retained by the laboratory for any further examination that might subsequently prove necessary. Additional specimens may be called for at the request of the laboratory.
 - 2.3.2. In case of other devices for indirect vision, one sample of all the parts.
3. INSCRIPTIONS

Specimens of a type of mirror or device for indirect vision other than a mirror submitted for EC component type-approval must bear the applicant's clearly visible and indelible trade mark or name and must allow sufficient space for the inscription of the EC component type-approval mark; this space must be indicated in the diagrams referred to in point 1.2.1.2 of Appendix 1 to this Annex.
4. APPLICATION FOR EC TYPE-APPROVAL OF A VEHICLE WITH REGARD TO THE INSTALLATION OF THE DEVICES FOR INDIRECT VISION
 - 4.1. The application for EC vehicle type-approval with regard to devices for indirect vision shall be made by the manufacturer.
 - 4.2. The model information document is reproduced in Appendix 3 to this Annex.
 - 4.3. For each type of vehicle the application shall be accompanied by:
 - 4.3.1. A vehicle representative of the type, the vehicle being if necessary determined by agreement with the technical department responsible for conducting the tests.
5. EC COMPONENT TYPE-APPROVAL
 - 5.1. Once the relevant requirements have been met, EC component type-approval shall be granted and a component type-approval number, in accordance with Annex VII to Directive 70/156/EEC, issued in respect of any mirror or device for indirect vision other than a mirror.
 - 5.2. This number shall not be assigned to any other type of device for indirect vision.
 - 5.3. The model EC type-approval certificate is reproduced in Appendix 2 to this Annex.
6. MARKING

Any device for indirect vision conforming to a type in respect of which component type-approval has been granted pursuant to this Directive shall bear an EC component type-approval mark as specified in Appendix 5.
7. EC VEHICLE TYPE-APPROVAL
 - 7.1. Once the relevant requirements have been met, EC vehicle type-approval shall be granted in respect of any type of vehicles.
 - 7.2. The model EC type-approval certificate is reproduced in Appendix 4 to this Annex.
 - 7.3. A type-approval number in accordance with Annex VII of Directive 70/156/EEC is assigned to each vehicle type. The same Member State must not assign the same number to another vehicle type.

▼B

8. TYPE MODIFICATIONS AND AMENDMENTS TO THE APPROVALS
 - 8.1. Where type modifications are made to the type of vehicle or type of device for indirect vision approved pursuant to this Directive, the provisions of Article 5 of Directive 70/156/EEC shall apply.
9. CONFORMITY OF PRODUCTION (VEHICLES AND COMPONENTS)
 - 9.1. Measures to ensure conformity of production must be taken in accordance with the provisions laid down in Article 10 of Directive 70/156/EEC.



Appendix 1

Information document No ... relating to EC type-approval of a device for indirect vision

Directive 2003/97/EC of the European Parliament and of the Council

The following information, if applicable, must be supplied in triplicate and must include a list of contents. Any drawings must be supplied in appropriate scale and in sufficient detail on size A4 on a folder of A4 format. Photographs, if any, must show sufficient detail.

0. GENERAL
 - 0.1. Make (trade name of manufacturer):
 - 0.2. Type:
 - 0.3. Means of identification of the type, if indicated on the device:
.....
 - 0.4. Category of vehicle for which the device is intended:
 - 0.5. Name and address of manufacturer:
 - 0.7. Location of and method of affixing the EC type-approval mark:
.....
 - 0.8. Address(es) of the production plant(s):
1. DEVICE FOR INDIRECT VISION
 - 1.1. Mirrors (state for each mirror)
 - 1.1.3. Variant:
 - 1.1.4. Drawing(s) for the identification of the mirror:
 - 1.1.5. Details of the method of attachment:
 - 1.2. Devices for indirect vision other than mirrors
 - 1.2.1. Type and characteristics (such as a complete description of the device):
 - 1.2.1.1. In the case of camera-monitor device, the detection distance (mm), contrast, luminance range, glare correction, display performance (black and white/colour), image repetition frequency, luminance reach of the monitor:
 - 1.2.1.2. Sufficiently detailed drawings to identify the complete device including the installation instructions; the position for the EC type-approval mark has to be indicated on the drawings:

▼ B

Appendix 2

Model EC component type-approval certificate for a device for indirect vision

Notification concerning the grant, refusal, withdrawal or extension of EC component type-approval for a type of device for indirect vision

Name of Administration

EC component type-approval No:

1. Trade name or mark:
2. Identification of the devices: mirror, camera/monitor, other device ⁽¹⁾:
 — in the case of a mirror Class (I, II, III, IV, V, VI) ⁽¹⁾

 — in the case of a camera/monitor or other device for indirect vision (S) ⁽¹⁾
3. Name and address of manufacturer:
4. If applicable, name and address of manufacturer's authorised representative:
5. Symbol $\frac{\Delta}{2m}$ defined in point 4.1.1 of part A of Annex II: yes/no ⁽¹⁾:
6. Submitted for type-approval on:
7. Test laboratory:
8. Date and number of laboratory report:
9. Date of grant/refusal/withdrawal/extension of EC component type-approval ⁽¹⁾:
10. Place:
11. Date:
12. The following documents, bearing the type-approval number shown above, are annexed to this type-approval certificate:

.....

(Descriptive notes, drawings, diagrams and plans)

These documents must be supplied to the competent authorities of the other Member States at their express request.

Remarks, if any, particularly as regards restrictions on use and/or conditions for fitting:

.....

.....

(Signature)

⁽¹⁾ Delete where inapplicable.



Appendix 3

Information document No ... relating to EC type-approval of a vehicle

Directive 2003/97/EC of the European Parliament and of the Council

The following information, if applicable, must be supplied in triplicate and must include a list of contents. Any drawings must be supplied in appropriate scale and in sufficient detail on size A4 on a folder of A4 format. Photographs, if any, must show sufficient detail.

- 0. GENERAL
 - 0.1. Make (trade name of manufacturer):
 - 0.2. Type:
 - 0.2.1. Commercial description (if applicable):
 - 0.3. Means of identification of the type, if indicated on the vehicle:
 - 0.3.1. Location of that marking:
 - 0.4. Category of vehicle ⁽¹⁾:
 - 0.5. Name and address of manufacturer:
 - 0.8. Address(es) of the production plant(s):
- 1. GENERAL CONSTRUCTION CHARACTERISTICS OF THE VEHICLE
 - 1.1. Photographs and/or drawings of a representative vehicle:
 - 1.7. Driving cab (forward control or bonneted) ⁽²⁾:
 - 1.8. Driving position: left/right ⁽²⁾:
 - 1.8.1. Vehicle is equipped to be driven in right-hand/left-hand traffic ⁽²⁾: ...
 - 2.4. Range of vehicle dimensions (overall):
 - 2.4.1. For chassis without bodywork:
 - 2.4.1.2. Width ^(k):
 - 2.4.1.2.1. Maximum permissible width:
 - 2.4.1.2.2. Minimum permissible width:
 - 2.4.2. For chassis with bodywork:
 - 2.4.2.2. Width ^(k):
- 9. BODYWORK
 - 9.9. Devices for indirect vision.....
 - 9.9.1. Mirrors:
 - 9.9.1.4. Drawing(s) showing the position of the mirror relative to the vehicle structure:
 - 9.9.1.5. Details of the method of attachment including that part of the vehicle structure to which it is attached:
 - 9.9.1.6. Optional equipment which may affect the rearward field of vision:
 - 9.9.1.7. A brief description of the electronic components (if any) of the adjustment device:
 - 9.9.2. Devices for indirect vision other than mirrors:
 - 9.9.2.1.2. Sufficiently detailed drawings with the installation instructions:

⁽¹⁾ Within the meaning of Annex IIA to Directive 70/156/EEC.

⁽²⁾ Delete where inapplicable.



Appendix 4

**Model EC type-approval certificate for a vehicle with regard to the
installation of devices for indirect vision**

Articles 4(2) and 10 of Council Directive 70/156/EEC of 6 February 1970 on the approximation of the laws of the Member States relating to the type-approval of motor vehicles and their trailers

Name of Administration

EC type-approval No: ... extension ⁽¹⁾

1. Trade name or mark of vehicle:
2. Type of vehicle:
3. Category of vehicle (M₁, M₂, M₃, N₁, N₂ ≤ 7,5 t, N₂ > 7,5 t, N₃) ⁽²⁾
 - 3.1. Type of category N₃ vehicle: rigid lorry/trailer/semi-trailer ⁽²⁾
4. Name and address of manufacturer:
5. If applicable, name and address of authorised representative:
6. Trade name or mark of mirrors and supplementary devices for indirect vision and component type-approval number.....
7. Class(es) of mirrors and devices for indirect vision (I, II, III, IV, V, VI, S) ⁽²⁾
8. Extension of EC type-approval of the vehicle to cover the following device for indirect vision:
9. Data for identification of the R point of the driver's seating position:
10. Maximum and minimum bodywork widths in respect of which the mirror and the device for indirect vision has been granted type-approval (in the case of chassis/cabs referred to in point 3.3 of Annex III):
11. Vehicle submitted for EC type-approval on:
12. Technical department responsible for checking conformity for the purpose of EC type-approval:
13. Date of report issued by that department:
14. Number of report issued by that department:
15. EC type-approval in respect of the installation of devices for indirect vision has been granted/refused ⁽²⁾
16. An extension of EC type-approval in respect of the installation of devices for indirect vision has been granted/refused ⁽²⁾
17. Place:
18. Date:

⁽¹⁾ Where appropriate, state whether the extension of the initial EC type-approval is the first, second, etc.

⁽²⁾ Delete where inapplicable.

▼B

19. Signature:
20. The following documents, bearing the type-approval number shown above, are annexed to this certificate:
 - drawings showing the mountings of the devices for indirect vision;
 - drawings and plans showing the mounting positions and characteristics of the part of the structure where the devices for indirect vision are mounted;
 - general view from the front, the rear and the passenger compartment showing where the devices for indirect vision are fitted.

These documents must be supplied to the competent authorities of the other Member States at their express request.

▼B*Appendix 5***EC component type-approval mark**

1. GENERAL

- 1.1. The EC component type-approval mark shall consist of a rectangle surrounding the lower case letter 'e' followed by the distinguishing number of the Member State which has granted the component type-approval: 1 for Germany, 2 for France, 3 for Italy, 4 for the Netherlands, 5 for Sweden, 6 for Belgium, ►**M1** 7 for Hungary, 8 for the Czech Republic, ◀ 9 for Spain, 11 for the United Kingdom, 12 for Austria, 13 for Luxembourg, 17 for Finland, 18 for Denmark, ►**M2** 19 for Romania, ◀ ►**M1** 20 for Poland, ◀ 21 for Portugal, 23 for Greece, 24 for Ireland ►**M1**, 26 for Slovenia, 27 for Slovakia, 29 for Estonia, 32 for Latvia, ►**M2** 34 for Bulgaria, ◀36 for Lithuania, 49 for Cyprus, 50 for Malta ◀ . It must also include in the vicinity of the rectangle the EC component type-approval number. This number shall consist of the component type-approval number shown on the certificate completed for the type (see Appendix 3), preceded by two figures indicating the sequence number of the latest amendment to this Directive on the date EC component type-approval was granted. The amendment sequence number and the component type-approval number shown on the certificate shall be separated by an asterisk. In this Directive the sequence number is 03.
- 1.2. The EC component type-approval mark shall be completed by the addition of the symbol I or II or III or IV or V or VI, specifying the class to which the type of mirror belongs or the symbol S in case of any device for indirect vision other than a mirror. The additional symbol shall be placed in any convenient position in the vicinity of the rectangle containing the letter 'e'.
- 1.3. The EC component type-approval mark and the additional symbol shall be indelibly inscribed on an integral part of the mirror or any other device for indirect vision other than a mirror in such a way as to be clearly visible even after the mirror or other device for indirect vision has been mounted on a vehicle.

2. EXAMPLES OF THE EC COMPONENT TYPE-APPROVAL MARK

- 2.1. Five examples of EC component type-approval marks, completed by the additional symbol are given below.

Examples of EC component type-approval marks and the additional symbol

Example No 1

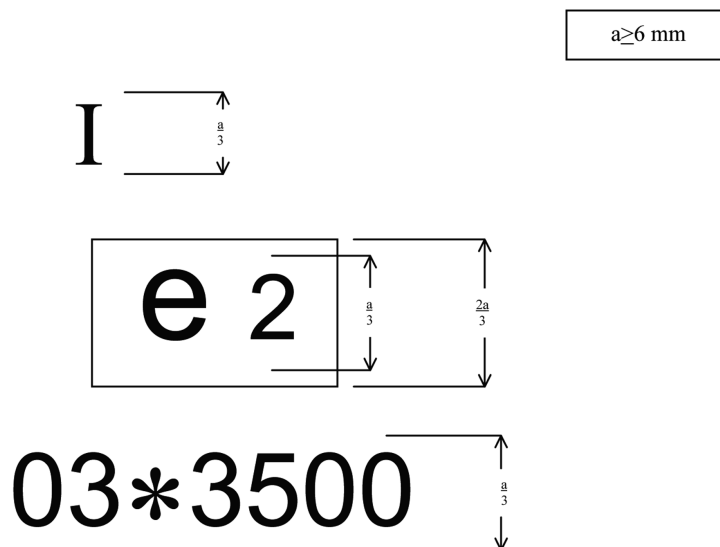

The mirror bearing the EC component type-approval mark shown above is a Class I mirror (interior rear-view), which has been approved in France (e2) under number 03*3500.

▼ B

Example No 2

a ≥ 6 mm

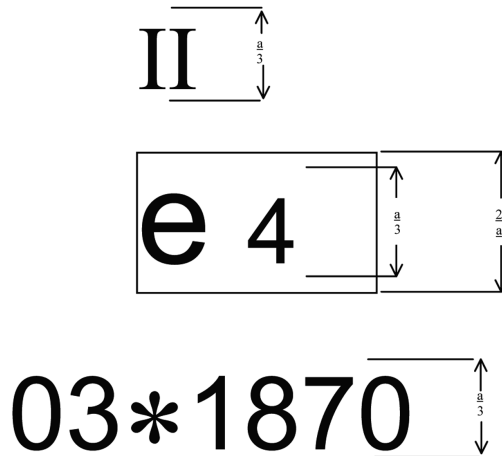

The mirror bearing the EC component type-approval mark shown above is a Class II mirror (exterior rear-view), which has been approved in the Netherlands (e4) under the number 03*1870.

Example No 3

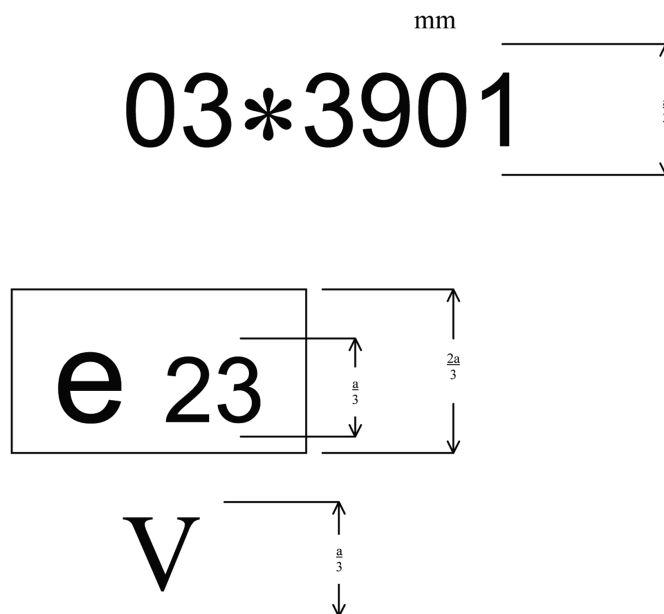

The mirror bearing the EC component type-approval mark shown above is a Class V mirror (close proximity), which has been approved in Greece (e23) under the number 03*3901.

▼B

Example No 4

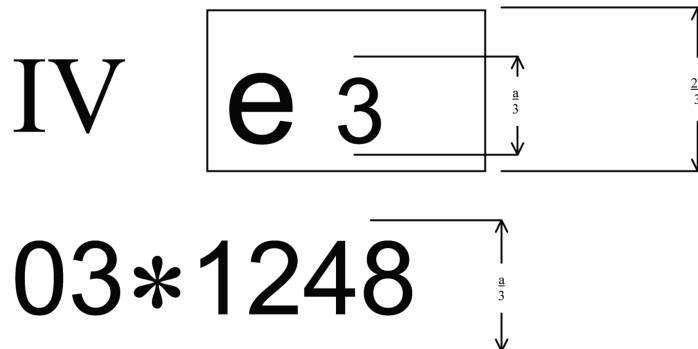
 $a \geq 6 \text{ mm}$

The mirror bearing the EC component type-approval mark shown above is a Class IV mirror (exterior rear-view — wide angle), which has been approved in Italy (e3) under the number 03*1248.

Example No 5

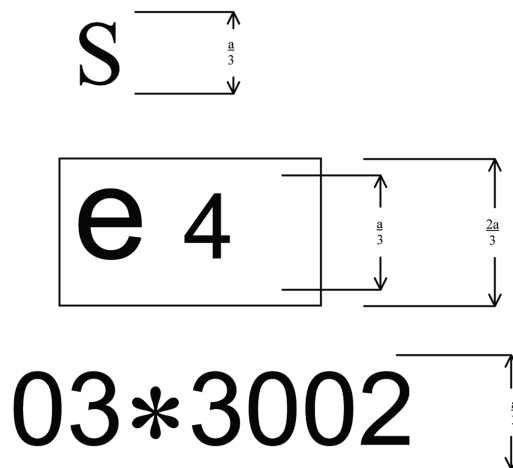
 $a \geq 6 \text{ mm}$ 

Explanation:

The device for indirect vision bearing the EC component type-approval mark shown above is a device for indirect vision (S), other than a mirror which has been approved in the Netherlands (e4) under number 03*3002.

▼B

Appendix 6

Procedure for determining the H point and verifying the relative positions of the R and H points

The relevant parts of Annex III to Directive 77/649/EEC are applicable.

▼ **M1***Appendix 7***Determination of the ocular points for a seat with a fixed seat-back angle**

1. The position of the ocular points in relation to the R point shall be adjusted as indicated in the table below by X coordinates from the three-dimensional reference grid. The table indicates the basic coordinates for a fixed seat-back angle of 25 degrees. The three-dimensional reference grid for the coordinates is as defined in point 2.3 of Annex I to Directive 77/649/EEC as amended.

Seat back angle	Horizontal coordinates
<i>(in degrees)</i>	ΔX
25	68 mm

2. Further correction for fixed seat-back angles other than 25

The table below indicates the further corrections, from the ocular position with a fixed seat-back angle of 25 degrees, to be made to the X and Z coordinates of the ocular points when the design seat-back angle is not 25 degrees.

Seat-back angle	Horizontal coordinates	Vertical coordinates
<i>(in degrees)</i>	ΔX	ΔZ
5	- 186 mm	28 mm
6	- 177 mm	27 mm
7	- 167 mm	27 mm
8	- 157 mm	27 mm
9	- 147 mm	26 mm
10	- 137 mm	25 mm
11	- 128 mm	24 mm
12	- 118 mm	23 mm
13	- 109 mm	22 mm
14	- 99 mm	21 mm
15	- 90 mm	20 mm
16	- 81 mm	18 mm
17	- 72 mm	17 mm
18	- 62 mm	15 mm
19	- 53 mm	13 mm
20	- 44 mm	11 mm
21	- 35 mm	9 mm
22	- 26 mm	7 mm
23	- 18 mm	5 mm
24	- 9 mm	3 mm
25	0 mm	0 mm
26	9 mm	- 3 mm

▼ M1

Seat-back angle	Horizontal coordinates	Vertical coordinates
<i>(in degrees)</i>	ΔX	ΔZ
27	17 mm	– 5 mm
28	26 mm	– 8 mm
29	34 mm	– 11 mm
30	43 mm	– 14 mm
31	51 mm	– 18 mm
32	59 mm	– 21 mm
33	67 mm	– 24 mm
34	76 mm	– 28 mm
35	84 mm	– 32 mm
36	92 mm	– 35 mm
37	100 mm	– 39 mm
38	108 mm	– 43 mm
39	115 mm	– 48 mm
40	123 mm	– 52 mm

▼B

ANNEX II

**DESIGN SPECIFICATIONS AND TESTS REQUIRED FOR EC
COMPONENT TYPE-APPROVAL OF A DEVICE FOR INDIRECT
VISION**

A. MIRRORS

1. **General specifications**

- 1.1. All mirrors must be adjustable.
- 1.2. The edge of the reflecting surface must be enclosed in a protective housing (holder, etc.) which, on its perimeter, must have a value 'c' greater than or equal to 2,5 mm at all points and in all directions. If the reflecting surface projects beyond the protective housing, the radius of curvature 'c' on the edge of the projecting part must be not less than 2,5 mm and the reflecting surface must return into the protective housing under a force of 50 N applied to the point of greatest projection, relative to the protective housing, in a horizontal direction, approximately parallel to the longitudinal median plane of the vehicle.
- 1.3. When the mirror is mounted on a plane surface, all parts, irrespective of the adjustment position of the device, including those parts remaining attached to the support after the test provided for in point 4.2, which are in potential, static contact with a sphere either 165 mm in diameter in the case of an interior mirror or 100 mm in diameter in the case of an exterior mirror, must have a radius of curvature 'c' of not less than 2,5 mm.
- 1.3.1. Edges of fixing holes or recesses of which the diameter or longest diagonal is less than 12 mm are exempt from the radius requirements of point 1.3 provided that they are blunted.
- 1.4. The device for the attachment of mirrors to the vehicle must be so designed that a cylinder with a 70 mm radius, having as its axis the axis, or one of the axes, of pivot or rotation which ensures deflection of the mirror in the direction of impact concerned, passes through at least part of the surface to which the device is attached.
- 1.5. The parts of exterior mirrors referred to in points 1.2 and 1.3 which are made of a material with a Shore A hardness not exceeding 60 are exempt from the relevant provisions.
- 1.6. In the case of those parts of interior mirrors which are made of a material with a Shore A hardness of less than 50 and which are mounted on a rigid support, the requirements of points 1.2 and 1.3 shall only apply to the support.

2. **Dimensions**

2.1. Interior rear-view mirrors (Class I)

The dimensions of the reflecting surface must be such that it is possible to inscribe thereon a rectangle one side of which is 40 mm and the other 'a' mm in length, where

$$a = 150 \text{ mm} \times \frac{1}{1 + \frac{1\,000}{r}}$$

and r is the radius of curvature.

2.2. Main exterior rear-view mirrors (Classes II and III)

2.2.1. The dimensions of the reflecting surface must be such that it is possible to inscribe therein:

— a rectangle 40 mm high the base length of which, measured in millimetres, has the value 'a';

▼B

— a segment which is parallel to the height of the rectangle and the length of which, expressed in millimetres, has the value 'b'.

2.2.2. The minimum values of 'a' and 'b' are given in the table below:

Class of rear-view mirror	a [mm]	b [mm]
II	$\frac{170}{1 + \frac{1\ 000}{r}}$	200
III	$\frac{130}{1 + \frac{1\ 000}{r}}$	70

2.3. 'Wide-angle' exterior mirrors (Class IV)

The contours of the reflecting surface must be of simple geometric form and its dimensions such that it provides, if necessary in conjunction with a Class II exterior mirror, the field of vision specified in point 5.4 of Annex III.

2.4. 'Close-proximity' exterior mirrors (Class V)

The contours of the reflecting surface must be of simple geometric form and its dimensions such that the mirror provides the field of vision specified in point 5.5 of Annex III.

2.5. Front mirrors (Class VI)

The contours of the reflecting surface must be of simple geometric form and its dimensions such that the mirror provides the field of vision specified in point 5.6 of Annex III.

3. Reflecting surface and coefficients of reflection

3.1. The reflecting surface of a mirror must be either flat or spherically convex. Exterior mirrors may be equipped with an additional aspherical part provided that the main mirror fulfils the requirements of the indirect field of vision.

3.2. Differences between the radii of curvature of mirrors

3.2.1. The difference between r_i or r'_i , and r_p at each reference point must not exceed $0,15 r$.

3.2.2. The difference between any of the radii of curvature (r_{p1} , r_{p2} , and r_{p3}) and r must not exceed $0,15 r$.

3.2.3. When r is not less than 3 000 mm, the value of $0,15 r$ quoted in points 3.2.1 and 3.2.2 is replaced by $0,25 r$.

3.3. Requirements for aspherical parts of mirrors

3.3.1. Aspherical mirrors shall be of sufficient size and shape to provide useful information to the driver. This normally means a minimum width of 30 mm at some point.

3.3.2. The radius of curvature r_i of the aspherical part shall not be less than 150 mm.

3.4. Value of 'r' for spherical mirrors must not be less than:

3.4.1. 1 200 mm for interior rear-view mirrors (Class I);

3.4.2. 1 200 mm for Class II and III main exterior rear-view mirrors;

3.4.3. 300 mm for 'wide-angle' exterior mirrors (Class IV) and 'close-proximity' exterior mirrors (Class V);

3.4.4. 200 mm for front mirrors (Class VI).

▼B

- 3.5. The value of the normal coefficient of reflection, as determined according to the method described in Appendix 1 to this Annex, must be not less than 40 %.

In the case of reflecting surfaces with a changeable degree of reflection, the 'day' position must allow the colours of the signals used for road traffic to be recognised. The value of the normal coefficient of reflection in the 'night' position must be not less than 4 %.

- 3.6. The reflecting surface must retain the characteristics laid down in point 3.5 in spite of prolonged exposure to adverse weather conditions in normal use.

4. Tests

- 4.1. Mirrors shall be subjected to the tests described in point 4.2.

- 4.1.1. The test provided for in point 4.2 shall not be required in the case of any exterior mirror of which no part is less than 2 m from the ground, regardless of the adjustment position, when the vehicle is under a load corresponding to its maximum technically permissible mass.

This derogation also applies to the attachments of mirrors (attachment plates, arms, swivel joints, etc.) which are situated less than 2 m from the ground and which do not project beyond the overall width of the vehicle, measured in the transverse plane passing through the lowest mirror attachments or any other point forward of this plane if this configuration produces a greater overall width.

In such cases, a description specifying that the mirror must be mounted so as to conform to the abovementioned conditions for the positioning of its attachments on the vehicle must be provided.

Where advantage is taken of this derogation, the arm shall be indelibly marked with the symbol

$$\frac{\Delta}{2 \text{ m}}$$

and the type-approval certificate shall be endorsed to this effect.

- 4.2. Impact test

The test according to this paragraph is not to be carried out for devices integrated in the bodywork of the vehicle and providing a frontal deflecting area of an angle not more than 45 ° measured in relation to the longitudinal median plane of the vehicle, or devices not protruding more than 100 mm measured beyond the circumscribing bodywork of the vehicle according to 74/483/EEC.

- 4.2.1. Description of the test rig

- 4.2.1.1. The test rig consists of a pendulum capable of swinging about two horizontal axes at right angles to each other, one of which is perpendicular to the plane containing the 'release' trajectory of the pendulum.

The end of the pendulum comprises a hammer formed by a rigid sphere with a diameter of 165 ± 1 mm having a 5 mm thick rubber covering of Shore A hardness 50.

A device is provided which permits determination of the maximum angle assumed by the arm in the plane of release.

A support firmly fixed to the structure of the pendulum serves to hold the specimens in compliance with the impact requirements specified in point 4.2.2.6.

▼ B

Figure 2 gives the dimensions of the test rig and the special design specifications:

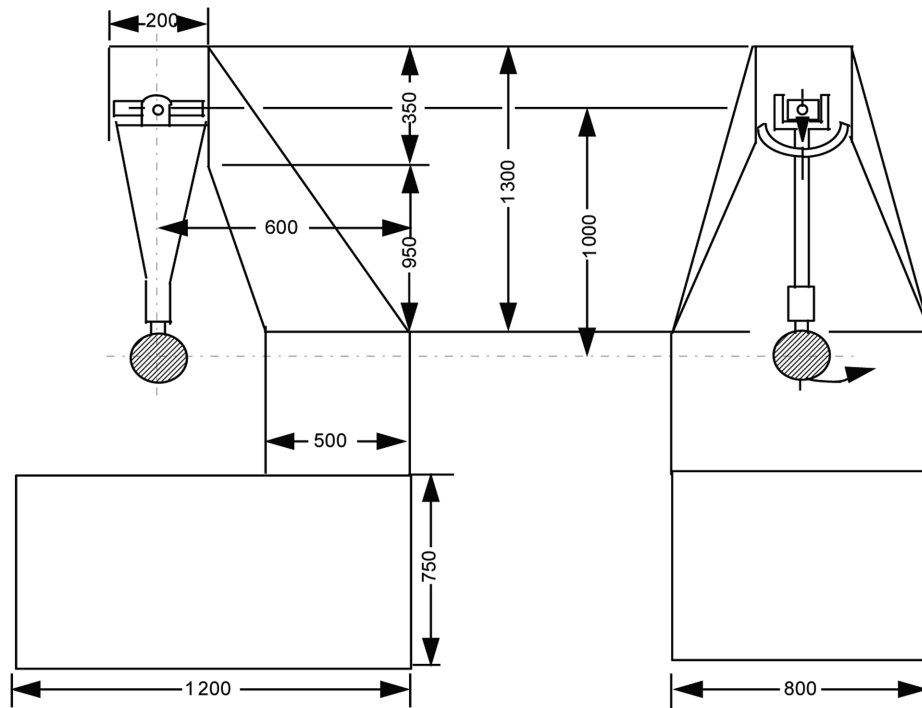

- 4.2.1.2. The centre of percussion of the pendulum coincides with the centre of the sphere, which forms the hammer. It is at a distance 'l' from the axis of oscillation in the release plane, which is equal to $1\text{ m} \pm 5\text{ mm}$. The reduced mass of the pendulum is $m_o = 6,8 \pm 0,05$ kilograms. The relationship of 'm_o' to the total mass 'm' of the pendulum and to the distance 'd' between the centre of gravity of the pendulum and its axis of rotation is expressed in the equation:

$$m_o = m \times \frac{d}{l}$$

4.2.2. Description of the test

- 4.2.2.1. The procedure used to clamp the mirror to the support shall be that recommended by the manufacturer of the device or, where appropriate, by the vehicle manufacturer.
- 4.2.2.2. Positioning of the mirror for the test
- 4.2.2.2.1. Mirrors shall be positioned on the pendulum impact rig in such a way that the axes which are horizontal and vertical when the mirror is installed on a vehicle in accordance with the applicant's mounting instructions are in a similar position.
- 4.2.2.2.2. When a mirror is adjustable with respect to the base, the test position shall be that in which any pivoting device is least likely to operate, within the limits of adjustment provided by the applicant.
- 4.2.2.2.3. When the mirror has a device for adjusting its distance from the base, the device must be set in the position in which the distance between the housing and the base is shortest.
- 4.2.2.2.4. When the reflecting surface is mobile in the housing, it shall be so adjusted that the upper corner, which is furthest from the vehicle, is in the position of greatest projection relative to the housing.
- 4.2.2.3. Except in the case of test 2 for interior mirrors (see point 4.2.2.6.1), when the pendulum is in a vertical position, the horizontal and longitudinal vertical planes passing through the centre of the hammer shall

▼B

pass through the centre of the reflecting surface as defined in point 1.1.1.10 of Annex I. The longitudinal direction of oscillation of the pendulum shall be parallel to the longitudinal median plane of the vehicle.

- 4.2.2.4. When, under the conditions governing adjustment laid down in points 4.2.2.1 and 4.2.2.2 parts of the mirror limit the return of the hammer, the point of impact must be displaced in a direction perpendicular to the axis of rotation or pivoting in question.

The displacement must be no greater than is strictly necessary for the execution of the test; it must be limited in such a way that:

- either the sphere delimiting the hammer remains at least tangential to the cylinder as defined in point 1.4;
- or the point of contact with the hammer is located at least 10 mm from the periphery of the reflecting surface.

- 4.2.2.5. The test consists in allowing the hammer to fall from a height corresponding to a pendulum angle of 60 ° from the vertical so that the hammer strikes the mirror at the moment when the pendulum reaches the vertical position.

- 4.2.2.6. The mirrors are subjected to impact under the following different conditions:

4.2.2.6.1. Interior mirrors

- Test 1: The points of impact shall be as defined in point 4.2.2.3. The impact must be such that the hammer strikes the mirror on the reflecting surface side.
- Test 2: Point of impact on the edge of the protective housing, such that the impact produced makes an angle of 45 ° with the plane of the reflecting surface and is situated in the horizontal plane passing through the centre of that surface. The impact must occur on the reflecting surface side.

4.2.2.6.2. Exterior mirrors

- Test 1: The point of impact shall be as defined in point 4.2.2.3 or 4.2.2.4. The impact must be such that the hammer strikes the mirror on the reflecting surface side.
- Test 2: The point of impact shall be as defined in point 4.2.2.3 or 4.2.2.4. The impact must be such that the hammer strikes the mirror on the side opposite to the reflecting surface.

Where Class II or III rear-view mirrors are fixed to the same mounting as Class IV rear-view mirrors, the abovementioned tests shall be executed on the lower mirror. Nevertheless, the technical service responsible for testing may repeat one or both of these tests on the upper mirror if this is less than 2 m from the ground.

5. Results of the test

- 5.1. In the tests described in point 4.2, the pendulum must continue to swing after impact in such a way that the projection of the position assumed by the arm on the plane of release makes an angle of at least 20 ° with the vertical. The accuracy of measurement of the angle shall be within $\pm 1^\circ$.
- 5.1.1. This requirement is not applicable to mirrors stuck to the windscreen, in respect of which the requirement stipulated in point 5.2 shall apply after the test.
- 5.1.2. The required angle to the vertical is reduced from 20 ° to 10 ° for all Class II and Class IV rear-view mirrors and for Class III rear-view mirrors which are attached to the same mounting as Class IV mirrors.
- 5.2. Should the mounting of the mirror break during the tests described in point 4.2 for mirrors stuck to the windscreen, the part remaining must not project beyond the base by more than 10 mm and the configuration remaining after the test must satisfy the conditions laid down in point 1.3.

▼B

- 5.3. The reflecting surface must not break during the tests described in point 4.2. However breakage of the reflecting surface will be allowed if one of the following conditions is fulfilled:
 - 5.3.1. The fragments of glass still adhere to the back of the housing or to a surface firmly attached to the housing; partial separation of the glass from its backing is admissible provided this does not exceed 2,5 mm on either side of the cracks. It is permissible for small splinters to become detached from the surface of the glass at the point of impact;
 - 5.3.2. The reflecting surface is made of safety glass.

B. DEVICES FOR INDIRECT VISION OTHER THAN MIRRORS**1. General requirements**

- 1.1. If adjustment by the user is needed, the device for indirect vision shall be adjustable without the use of tools.
- 1.2. If a device for indirect vision can only render the total prescribed field of vision by scanning the field of vision, the total process of scanning, rendering and reset to its initial position together shall not take more than two seconds.

2. Camera-monitor devices for indirect vision**2.1. General requirements**

- 2.1.1. When the camera-monitor device for indirect vision is mounted on a plane surface, all parts, irrespective of the adjustment position of the device which are in potential, static contact with a sphere either 165 mm in diameter in the case of a monitor or 100 mm in diameter in the case of a camera, must have a radius of curvature 'c' of not less than 2,5 mm.
- 2.1.2. Edges of fixing holes or recesses of which the diameter or longest diagonal is less than 12 mm are exempt from the radius requirements of point 2.1.1 provided that they are blunted.
- 2.1.3. For parts of the camera and the monitor which are made of a material with a Shore A hardness of less than 60 and which are mounted on a rigid support, the requirements of point 2.1.1 shall only apply to the support.

2.2. Functional requirements

- 2.2.1. The camera should function well under low sunlight conditions. The camera shall provide a luminance contrast of at least 1:3 under low sun condition in a region outside the part of the image where the light source is reproduced (condition as defined in EN 12368:8.4). The light source shall illuminate the camera with 40 000 lx. The angle between the normal of the sensor plane and the line connecting the midpoint of the sensor and the light source shall be 10 °.
- 2.2.2. The monitor shall render a minimum contrast under various light conditions as specified by draft international standard ISO/DIS 15008 [2].
- 2.2.3. It shall be possible to adjust the average luminance of the monitor either manually or automatically to the ambient conditions.
- 2.2.4. The measurements for the luminance contrast shall be carried out according to ISO/DIS 15008.

3. Other devices for indirect vision

It has to be proved that the device meets the following requirements:

- 3.1. The device shall perceive the visual spectrum and shall always render this image without the need for interpretation into the visual spectrum.
- 3.2. The functionality shall be guaranteed under the circumstances of use in which the system shall be put into service. Depending on the technology used in obtaining images and presenting them point 2.2 shall be entirely or partly applicable. In other cases this can be achieved by establishing and demonstrating by means of system sensitivity

▼B

analogous to point 2.2 that a function is ensured that is comparable to or better than what is required for and by demonstrating that a functionality is guaranteed that is equivalent or better than that required for mirror- or camera-monitor devices for indirect vision.

▼B*Appendix 1***Procedure for determining the radius of curvature 'r' of the reflecting surface of a mirror****1. Measurement****1.1. Equipment**

A 'spherometer' similar to the one described in Figure 3 having the indicated distances between the tracing pin of the dial gauge and the fixed legs of the bar is used.

1.2. Measuring points

1.2.1. The principal radii of curvature shall be measured at three points situated as close as possible to positions at one-third, one-half and two-thirds of the distance along the arc of the reflecting surface passing through the centre of this surface and parallel to segment b, or of the arc passing through the centre of the reflecting surface which is perpendicular to it if this arc is the longer.

1.2.2. Where, owing to the size of the reflecting surface, it is impossible to obtain measurements in the directions defined in point 1.1.1.5 of Annex I, the technical services responsible for the tests may take measurements at the said point in two perpendicular directions as close as possible to those prescribed above.

2. Calculation of the radius of curvature 'r'

'r' expressed in mm is calculated from the formula:

$$r = \frac{r_{p1} + r_{p2} + r_{p3}}{3}$$

where:

r_{p1} : the radius of curvature at the first measuring point,

r_{p2} : the radius of curvature at the second measuring point,

r_{p3} : the radius of curvature at the third measuring point.

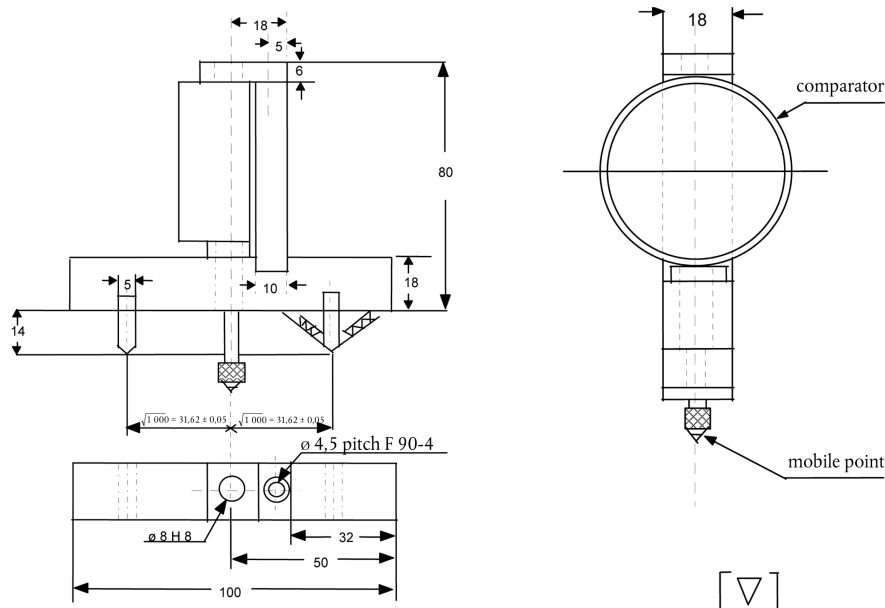

Figure 3: spherometer



Appendix 2

Test method for determining reflectivity

1. DEFINITIONS

- 1.1. CIE standard illuminate A ⁽¹⁾: Colorimetric illuminate, respecting the full radiator at $T_{68} = 2\,855,6$ K.
- 1.2. CIE standard source A ⁽¹⁾: Gas-filled tungsten filament lamp operating at a correlated colour temperature of $T_{68} = 2\,855,6$ K.
- 1.3. CIE 1931 standard colorimetric observer ⁽¹⁾: Receptor of radiation whose colorimetric characteristics correspond to the spectral tristimulus values $\bar{x}(\lambda)$, $\bar{y}(\lambda)$, $\bar{z}(\lambda)$ (see table).
- 1.4. CIE spectral tristimulus values ⁽¹⁾: Tristimulus values of the spectral components of an equi-energy spectrum in the CIE (XYZ) system.
- 1.5. Photopic vision ⁽¹⁾: Vision by the normal eye when it is adapted to levels of luminance of at least several cd/m^2 .

2. APPARATUS

2.1. General

The apparatus shall consist of a light source, a holder for the test sample, a receiver unit with a photodetector and an indicating meter (see Figure 4), and means of eliminating the effects of extraneous light.

The receiver may incorporate a light-integrating sphere to facilitate measuring the reflectance of non-flat (convex) mirrors (see Figure 5).

2.2. Spectral characteristics of light source and receiver

The light source shall consist of a CIE standard source A and associated optics to provide a near-collimated light beam. A voltage stabiliser is recommended in order to maintain a fixed lamp voltage during instrument operation.

The receiver shall have a photodetector with a spectral response proportional to the photopic luminosity function of the CIE (1931) standard colorimetric observer (see table). Any other combination of illuminate-filter-receptor giving the overall equivalent of CIE standard illuminate A and photopic vision may be used. When an integrating sphere is used in the receiver, the interior surface of the sphere shall be coated with a matt (diffusive) spectrally non-selective white coating.

2.3. Geometrical conditions

The angle of the incident beam ⁽⁰⁾ should preferably be $0,44 \pm 0,09$ rad ($25 \pm 5^\circ$) from the perpendicular to the test surface and shall not exceed the upper limit of the tolerance (i.e. $0,53$ rad or 30°). The axis of the receptor shall make an angle ⁽⁰⁾ with this perpendicular equal to that of the incident beam (see Figure 4). The incident beam upon arrival at the test surface shall have a diameter of not less than 13 mm ($0,5$ in.). The reflected beam shall not be wider than the sensitive area of the photodetector, shall not cover less than 50% of such area, and as nearly as possible shall cover the same area segment as used during instrument calibration.

When an integrating sphere is used in the receiver section, the sphere shall have a minimum diameter of 127 mm (5 in.). The sample and incident beam apertures in the sphere wall shall be of such a size as to admit the entire incident and reflected light beams. The photodetector shall be so located as not to receive direct light from either the incident or the reflected beam.

⁽¹⁾ Definitions taken from CIE publication 50 (45), International Electrotechnical Vocabulary, Group 45: Lighting.

▼B**2.4. Electrical characteristics of the photodetector-indicator unit**

The photodetector output as read on the indicating meter shall be a linear function of the light intensity of the photosensitive area. Means (electrical and/or optical) shall be provided to facilitate zeroing and calibration adjustments. Such means shall not affect the linearity or the spectral characteristics of the instrument. The accuracy of the receptor-indicator unit shall be within $\pm 2\%$ of full scale, or $\pm 10\%$ of the magnitude of the reading, whichever is the smaller.

2.5. Sample holder

The mechanism shall be capable of locating the test sample so that the axes of the source arm and receptor intersect at the reflecting surface. The reflecting surface may lie within or at either face of the mirror sample, depending on whether it is a first-surface, second-surface or prismatic 'flip'-type mirror.

3. PROCEDURE**3.1. Direct calibration method**

In the direct calibration method, air is used as the reference standard. This method is applicable for those instruments, which are so constructed as to permit calibration at the 100 % point by swinging the receiver to a position directly on the axis of the light source (see Figure 4).

It may be desired in some cases (such as when measuring low-reflectivity surfaces) to use an intermediate calibration point (between 0 and 100 % on the scale) with this method. In these cases, a neutral density filter of known transmittance shall be inserted in the optical path, and the calibration control shall then be adjusted until the meter reads the percentage transmission of the neutral density filter. This filter shall be removed before reflectivity measurements are performed.

3.2. Indirect calibration method

The indirect calibration method is applicable in the case of instruments with fixed source and receiver geometry. A properly calibrated and maintained reflectance standard is required. This reference standard should preferably be a flat mirror with a reflectance value as near as possible to that of the test samples.

3.3. Flat mirror measurement

The reflectance of flat mirror samples can be measured on instruments employing either the direct or the indirect calibration method. The reflectance value is read directly from the indicating meter.

3.4. Non-flat (convex) mirror measurement

Measurement of the reflectance of non-flat (convex) mirrors requires the use of instruments which incorporate an integrating sphere in the receiver unit (see Figure 5). If the instrument-indicating meter indicates n_c divisions with a standard mirror of $E\%$ reflectance, then, with a mirror of unknown reflectance, n_x divisions will correspond to a reflectance of $X\%$, in accordance with the formula:

$$X = E \frac{n_x}{n_c}$$

▼ B

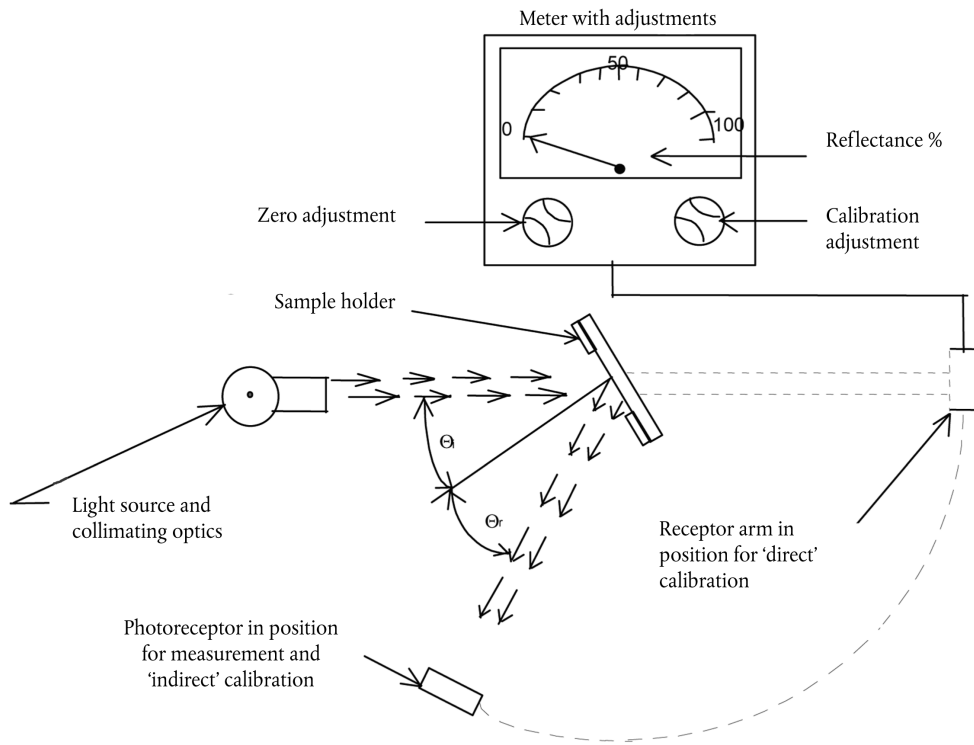

Figure 4: Generalised reflectometer showing experimental set-ups for the two calibration methods

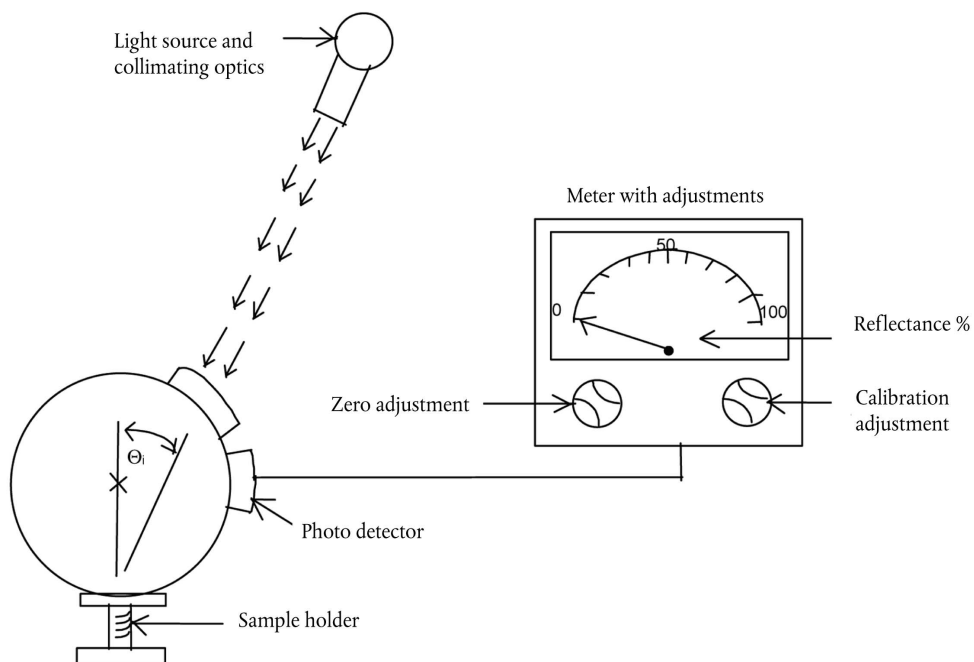

Figure 5: Generalised reflectometer, incorporating an integrating sphere in the receiver

▼ B

Spectral tristimulus values for the CIE 1931 standard colorimetric observer ⁽¹⁾

This table is taken from CIE publication 50 (45) (1970)

λ nm	$\bar{x}(\lambda)$	$\bar{y}(\lambda)$	$\bar{z}(\lambda)$
380	0,0014	0,0000	0,0065
390	0,0042	0,0001	0,0201
400	0,0143	0,0004	0,0679
410	0,0435	0,0012	0,2074
420	0,1344	0,0040	0,6456
430	0,2839	0,0116	1,3856
440	0,3483	0,0230	1,7471
450	0,3362	0,0380	1,7721
460	0,2908	0,0600	1,6692
470	0,1954	0,0910	1,2876
480	0,0956	0,1390	0,8130
490	0,0320	0,2080	0,4652
500	0,0049	0,3230	0,2720
510	0,0093	0,5030	0,1582
520	0,0633	0,7100	0,0782
530	0,1655	0,8620	0,0422
540	0,2904	0,9540	0,0203
550	0,4334	0,9950	0,0087
560	0,5945	0,9950	0,0039
570	0,7621	0,9520	0,0021
580	0,9163	0,8700	0,0017
590	1,0263	0,7570	0,0011
600	1,0622	0,6310	0,0008
610	1,0026	0,5030	0,0003
620	0,8544	0,3810	0,0002
630	0,6424	0,2650	0,0000
640	0,4479	0,1750	0,0000
650	0,2835	0,1070	0,0000
660	0,1649	0,0610	0,0000
670	0,0874	0,0320	0,0000
680	0,0468	0,0170	0,0000
690	0,0227	0,0082	0,0000
700	0,0114	0,0041	0,0000
710	0,0058	0,0021	0,0000
720	0,0029	0,0010	0,0000

⁽¹⁾ Abridged table. The values of $\bar{y}(\lambda) = V(\lambda)$ are rounded off to four decimal places.

▼B

λ nm	\bar{x} (λ)	\bar{y} (λ)	\bar{z} (λ)
730	0,0014	0,0005	0,0000
740	0,0007	0,0002 (*)	0,0000
750	0,0003	0,0001	0,0000
760	0,0002	0,0001	0,0000
770	0,0001	0,0000	0,0000
780	0,0000	0,0000	0,0000

(*) Changed in 1966 (from 3 to 2)

*ANNEX III***REQUIREMENTS CONCERNING THE FITTING OF MIRRORS AND OTHER DEVICES FOR INDIRECT VISION TO VEHICLES****General**

- 1.1. Mirrors and other devices for indirect vision must be fitted in such a way that the mirror or other device does not move so as significantly to change the field of vision as measured or vibrate to an extent which would cause the driver to misinterpret the nature of the image perceived.
- 1.2. The conditions laid down in item 1.1 must be maintained when the vehicle is moving at speeds of up to 80 % of its maximum design speed, but not exceeding 150 km/h.
- 1.3. The fields of vision defined below shall be established using ambinocular vision, the eyes being at the 'driver's ocular points' as defined in Annex I, point 1.1.1.12. The fields of vision shall be determined when the vehicle is in running order as defined in Directive 97/27/EC, Annex I, point 2.5. They shall be established through windows which have a total light transmission factor of at least 70 % measured normal to the surface.

Mirrors

2. Number
 - 2.1. Minimum number of compulsory mirrors
 - 2.1.1. The fields of vision prescribed in point 5 shall be obtained from the minimum number on mandatory mirrors set out in the following table. Where the presence of a mirror is not requested on a mandatory base, this means that no other system for indirect vision can be requested on a mandatory base.

Vehicle category	Exterior mirrors					
	Interior mirror	Main mirror (large) Class II	Main mirror (small) Class III	Wide-angle mirror Class IV	Close-proximity mirror Class V	Front mirror Class VI
M ₁	<p>Compulsory</p> <p>Unless a mirror would not provide rearward vision (as defined in item 5.1 Annex III)</p> <p>Optional</p> <p>If the mirror does not provide rearward vision</p>	Optional	<p>Compulsory</p> <p>One on the driver's side and one on the passenger's side. Class II mirrors may be fitted as an alternative.</p>	<p>Optional</p> <p>One on the driver's side and/or one on the passenger's side</p>	<p>Optional</p> <p>One on the driver's side and one on the passenger's side (both must be fitted at least 2 m above the ground)</p>	<p>Optional</p> <p>(must be fitted at least 2 m above the ground)</p>
M ₂	<p>Optional</p> <p>(no requirements for the field of view)</p>	<p>Compulsory</p> <p>One on the driver's side and one on the passenger's side</p>	Not permitted	<p>Optional</p> <p>One on the driver's side and/or one on the passenger's side</p>	<p>Optional</p> <p>One on the driver's side and one on the passenger's side (both must be fitted at least 2 m above the ground)</p>	<p>Optional</p> <p>(must be fitted at least 2 m above the ground)</p>
M ₃	<p>Optional</p> <p>(no requirements for the field of view)</p>	<p>Compulsory</p> <p>One on the driver's side and one on the passenger's side</p>	Not permitted	<p>Optional</p> <p>One on the driver's side and/or one on the passenger's side</p>	<p>Optional</p> <p>One on the driver's side and one on the passenger's side (both must be fitted at least 2 m above the ground)</p>	<p>Optional</p> <p>(must be fitted at least 2 m above the ground)</p>
N ₁	<p>Compulsory</p> <p>Unless a mirror would not provide rearward vision (as defined in item 5.1 Annex III)</p> <p>Optional</p> <p>If the mirror does not provide rearward vision</p>	Optional	<p>Compulsory</p> <p>One on the driver's side and one on the passenger's side. Class II mirrors may be fitted as an alternative.</p>	<p>Optional</p> <p>One on the driver's side and/or one on the passenger's side</p>	<p>Optional</p> <p>One on the driver's side and one on the passenger's side (both must be fitted at least 2 m above the ground)</p>	<p>Optional</p> <p>(must be fitted at least 2 m above the ground)</p>

Exterior mirrors						
Vehicle category	Interior mirror		Exterior mirrors			Front mirror Class VI
	Interior mirror Class I	Main mirror (large) Class II	Main mirror (small) Class III	Wide-angle mirror Class IV	Close-proximity mirror Class V	
N ₂ ≤ 7,5 t	Optional (no requirements for the field of view)	Compulsory One on the driver's side and one on the passenger's side	Not permitted	► M1 Compulsory For both sides if a Class V mirror can be fitted Optional For both sides together if not ◀	► M1 Compulsory, see Annex III items 3.7 and 5.5.5 One on the passenger's side Optional One on the driver's side (both must be fitted at least 2 m above the ground) A tolerance of + 10 cm may be applied ◀	Optional One front mirror (must be fitted at least 2 m above the ground)
N ₂ > 7,5 t	Optional (no requirements for the field of view)	Compulsory One on the driver's side and one on the passenger's side	Not permitted	Compulsory One on the driver's side and one on the passenger's side	Compulsory, see Annex III items 3.7 and 5.5.5 One on the passenger's side Optional One on the driver's side (both must be fitted at least 2 m above the ground)	Compulsory, see Annex III item 2.1.2 One front mirror (must be fitted at least 2 m above the ground)
N ₃	Optional (no requirements for the field of view)	Compulsory One on the driver's side and one on the passenger's side	Not permitted	Compulsory One on the driver's side and one on the passenger's side	Compulsory, see Annex III items 3.7 and 5.5.5 One on the passenger's side Optional One on the driver's side (both must be fitted at least 2 m above the ground)	Compulsory, see Annex III item 2.1.2. One front mirror (must be fitted at least 2 m above the ground)

▼B

- 2.1.2. In case the described field of vision of a front mirror prescribed in point 5.6 can be obtained by another device for indirect vision that is approved according to Annex II, part B and that is installed according to this Annex, this device can be used instead of a mirror.

In case a camera/monitor device is used the monitor must exclusively show the field of vision prescribed in point 5.6 while the vehicle is moving forward with a speed up to 30 km/h. In case the vehicle is moving with higher speed or moving backwards the monitor can be used to display the field of vision of other cameras mounted to the vehicle.

- 2.2. The provisions of this Directive do not apply to the surveillance mirrors defined in point 1.1.1.3 of Annex I. Nevertheless, the exterior surveillance mirrors must be mounted at least 2 m above the ground when the vehicle is under a load corresponding to its maximum technical permissible mass.

3. Position

- 3.1. Mirrors must be so placed that the driver, when sitting on the driving seat in a normal driving position, has a clear view of the road to the rear, side (s) or front of the vehicle.

- 3.2. Exterior mirrors shall be visible through the side windows or through the portion of the windscreen that is swept by the windscreen wiper. Nevertheless, for design reasons, this last provision (i.e. the provisions relating the cleaned part of the windscreen) shall not apply to:

- exterior mirrors on the passenger side of vehicles of categories M₂ and M₃;
- Class VI mirrors.

- 3.3. In the case of any vehicle, which is in chassis/cab form when the field of vision is measured, the minimum and maximum body widths shall be stated by the manufacturer and, if necessary, simulated by dummy headboards. All vehicles and mirror configurations taken into consideration during the tests shall be shown on the EC type-approval certificate for a vehicle with regard to the installation of mirrors (see Appendix 4 to Annex I).

- 3.4. The prescribed exterior mirror on the driver's side of the vehicle must be so located that an angle of not more than 55° is formed between the vertical longitudinal median plane of the vehicle and the vertical plane passing through the centre of the mirror and through the centre of the straight line 65 mm long which joins the driver's two ocular points.

- 3.5. Mirrors must not project beyond the external bodywork of the vehicle substantially more than is necessary to comply with the requirements concerning fields of vision laid down in point 5.

- 3.6. Where the lower edge of an exterior mirror is less than 2 m above the ground when the vehicle is loaded to its technically permissible maximum laden mass, this mirror must not project more than 250 mm beyond the overall width of the vehicle measured without mirrors.

- 3.7. Class V and Class VI mirrors shall be mounted on vehicles in such a way that, regardless of their position after adjustment, no part of these mirrors or their holders is less than 2 m from the ground when the vehicle is under a load corresponding to its technically permissible maximum laden mass.

These mirrors shall not, however, be mounted on vehicles the cab height of which is such as to prevent compliance with this requirement. In this case an other device for indirect vision is not required.

- 3.8. Subject to the requirements of points 3.5, 3.6 and 3.7, mirrors may project beyond the permissible maximum widths of vehicles.

4. Adjustment

- 4.1. The interior mirror must be capable of being adjusted by the driver from his driving position.

- 4.2. The exterior mirror situated on the driver's side must be capable of being adjusted from inside the vehicle while the door is closed, although the window may be open. The mirror may, however, be locked in position from the outside.

▼B

- 4.3. The requirements of point 4.2 do not apply to exterior mirrors which, after having been knocked out of alignment, can be returned to their former position without the need for adjustment.
5. Fields of vision
- 5.1. Interior rear-view mirror (Class I)

The field of vision must be such that the driver can see at least a 20 m wide, flat, horizontal portion of the road centred on the vertical longitudinal median plane of the vehicle and extending from 60 m behind the driver's ocular points (Figure 6) to the horizon.

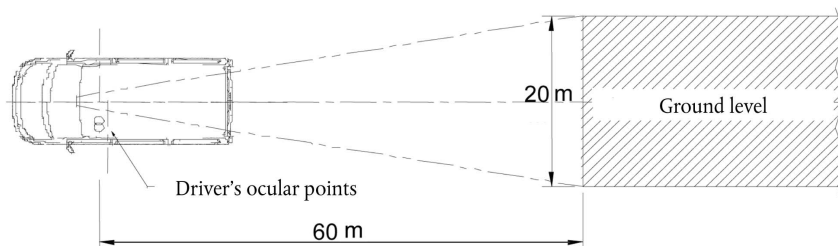

Figure 6: Field of vision of Class I mirror

- 5.2. Main exterior rear-view mirrors Class II
- 5.2.1. Exterior rear-view mirror on the driver's side

The field of vision must be such that the driver can see at least a 5 m wide, flat, horizontal portion of the road, which is bounded by a plane which is parallel to the median longitudinal vertical plane and passing through the outermost point of the vehicle on the driver's side of the vehicle and extends from 30 m behind the driver's ocular points to the horizon.

In addition, the road must be visible to the driver over a width of 1 m, which is bounded by a plane parallel to the median longitudinal vertical plane and passing through the outermost point of the vehicle starting from a point 4 m behind the vertical plane passing through the driver's ocular points (see Figure 7).

- 5.2.2. Exterior rear-view mirror on the passenger's side

The field of vision must be such that the driver can see at least a 5 m wide, flat, horizontal portion of the road, which is bounded on the passenger's side by a plane parallel to the median longitudinal vertical plane of the vehicle and passing through the outermost point of the vehicle on the passenger's side and which extends from 30 m behind the driver's ocular points to the horizon.

In addition, the road must be visible to the driver over a width of 1 m, which is bounded by a plane parallel to the median longitudinal vertical plane and passing through the outermost point of the vehicle starting from a point 4 m behind the vertical plane passing through the driver's ocular points (see Figure 7).

▼B

Figure 7: Field of vision of Class II mirrors

5.3. Main exterior rear-view mirrors Class III

5.3.1. Exterior rear-view mirror on the driver's side

The field of vision must be such that the driver can see at least a 4 m wide, flat, horizontal portion of the road, which is bounded by a plane parallel to the median longitudinal vertical plane and passing through the outermost point of the vehicle on the driver's side of the vehicle and extends from 20 m behind the driver's ocular points to the horizon (see Figure 8).

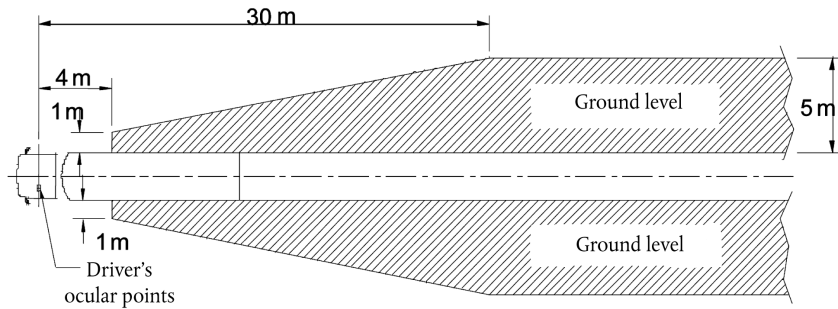
In addition, the road must be visible to the driver over a width of 1 m, which is bounded by a plane parallel to the median longitudinal vertical plane and passing through the outermost point of the vehicle starting from a point 4 m behind the vertical plane passing through the driver's ocular points.

5.3.2. Exterior rear-view mirror on the passenger's side

The field of vision must be such that the driver can see at least a 4 m wide flat, horizontal portion of the road which is bounded by a plane parallel to the median longitudinal vertical plane passing through the outermost point of the vehicle on the passenger's side and which extends from 20 m behind the driver's ocular points to the horizon (see Figure 8).

In addition, the road must be visible to the driver over a width of 1 m which is bounded by a plane which is parallel to the median longitudinal vertical plane and passing through the outermost point of the vehicle starting from a point 4 m behind the vertical plane passing through the driver's ocular points.

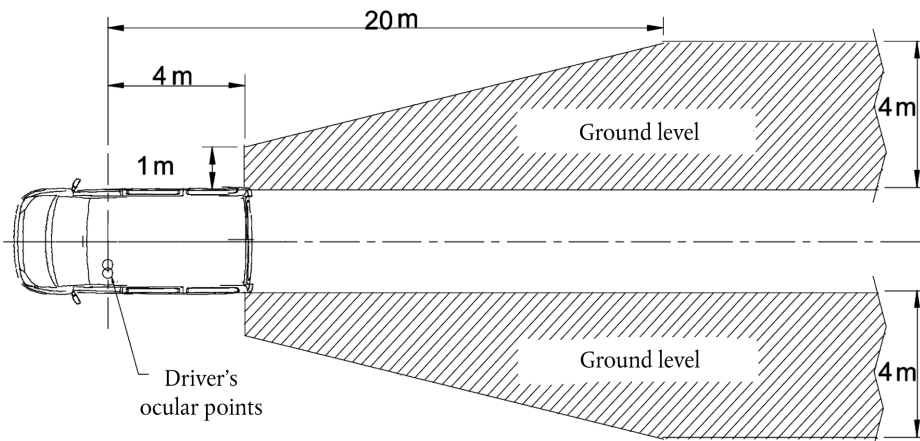

Figure 8: Field of vision of Class III mirrors

▼B

5.4. 'Wide-angle' exterior mirror (Class IV)

5.4.1. 'Wide-angle' exterior mirror on the driver's side

The field of vision must be such that the driver can see at least a 15 m-wide, flat, horizontal portion of the road, which is bounded by a plane parallel to the median longitudinal vertical plane of the vehicle and passing through the outermost point of the vehicle on the driver's side and which extends from at least 10 to 25 m behind the driver's ocular points.

In addition, the road must be visible to the driver over a width of 4,5 m, which is bounded by a plane parallel to the median longitudinal vertical plane and passing through the outermost point of the vehicle starting from a point 1,5 m behind the vertical plane passing through the driver's ocular points (see Figure 9).

5.4.2. 'Wide-angle' exterior mirror on the passenger's side

The field of vision must be such that the driver can see at least a 15 m-wide, flat, horizontal portion of the road, which is bounded by a plane parallel to the median longitudinal vertical plane of the vehicle and passing through the outermost point of the vehicle on the passenger's side and which extends from at least 10 to 25 m behind the driver's ocular points.

In addition, the road must be visible to the driver over a width of 4,5 m, which is bounded by a plane parallel to the median longitudinal vertical plane and passing through the outermost point of the vehicle starting from a point 1,5 m behind the vertical plane passing through the driver's ocular points (see Figure 9).

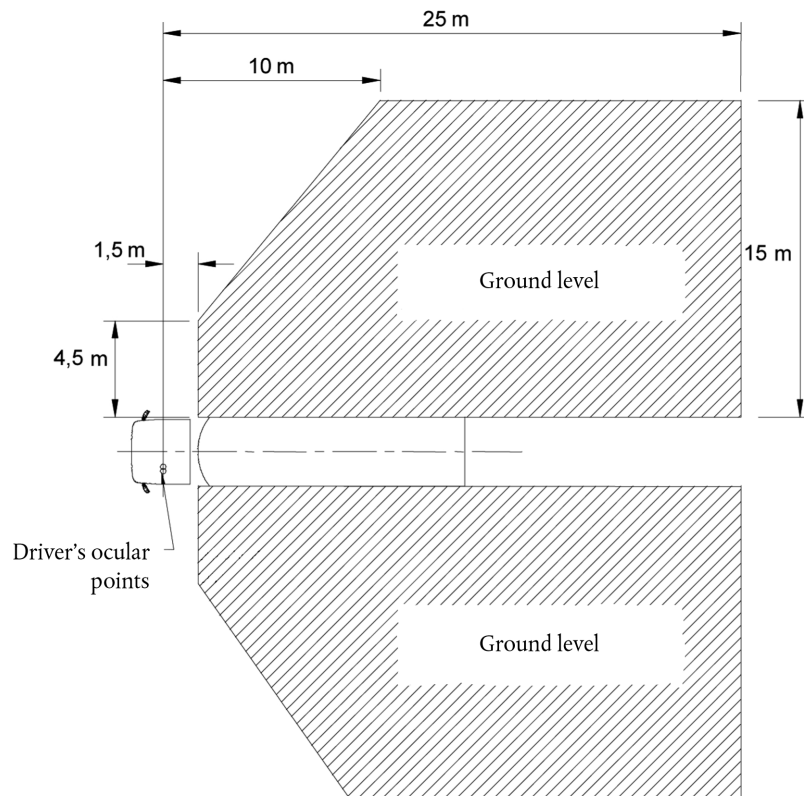

Figure 9: Field of vision of Class IV wide-angle mirrors

5.5. 'Close-proximity' exterior mirror (Class V)

The field of vision must be such that the driver can see a flat horizontal portion of the road along the side of the vehicle, bounded by the following vertical planes (see Figures 10a and 10b):

▼B

- 5.5.1. the plane parallel to the median longitudinal vertical plane of the vehicle which passes through the outermost point of the vehicle cab on the passenger's side;
- 5.5.2. in the transverse direction, the parallel plane passing at a distance of 2 m in front of the plane mentioned in point 5.5.1;
- 5.5.3. to the rear, the plane parallel to the vertical plane passing through the driver's ocular points and situated at a distance of 1,75 m behind that plane;
- 5.5.4. to the front, the plane parallel to the vertical plane passing through the driver's ocular points and situated at a distance of 1 m in front of that plane. If the vertical transverse plane passing through the leading edge of the vehicle bumper is less than 1 m in front of the vertical plane passing through the driver's ocular points, the field of vision shall be limited to that plane.
- 5.5.5. In case the field of vision described in Figures 10a and 10b can be perceived through the combination of the field of vision from a Class IV wide-angle mirror and that of a Class VI front mirror, the installation of a Class V close proximity mirror is not compulsory.

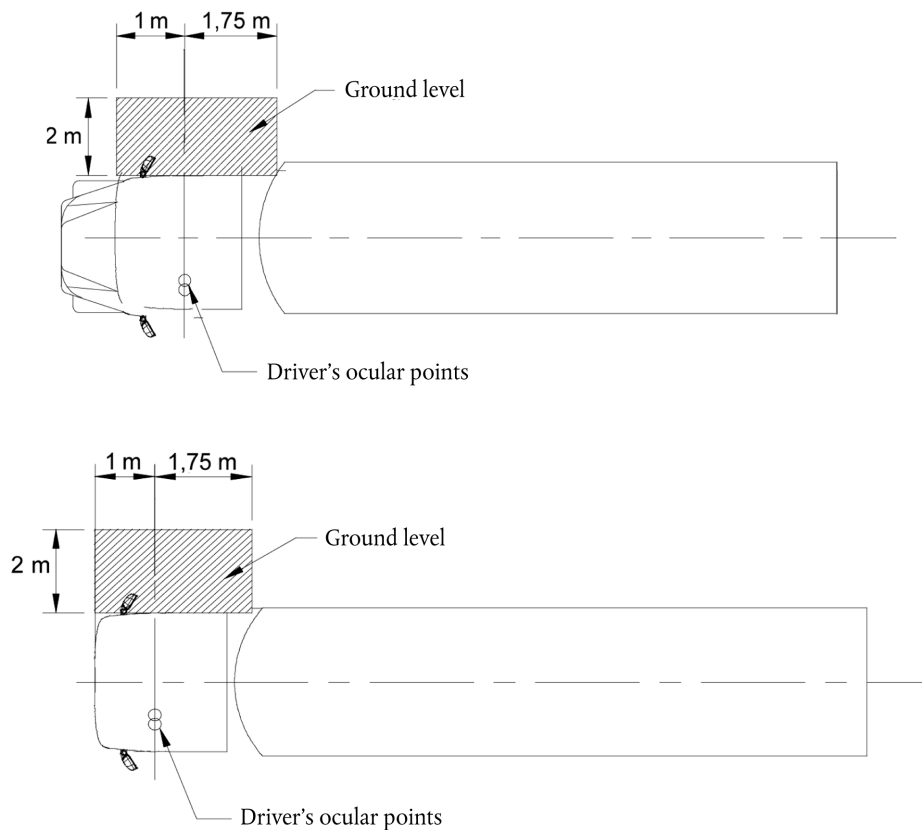

Figures 10a and 10b: Field of vision of Class V close-proximity mirror

- 5.6. Front mirror (Class VI)
 - 5.6.1. The field of vision must be such that the driver can see at least a flat horizontal portion of the road, which is bounded by:
 - one traverse vertical plane through the outermost point of the front of the vehicle-cab
 - one traverse vertical plane 2 000 mm in front of the vehicle
 - one longitudinal vertical plane parallel to the longitudinal vertical median plane going through the outermost side of the vehicle at the driver's side and

▼B

- one longitudinal vertical plane parallel to the longitudinal vertical median plane 2 000 mm outside the outermost side of the vehicle opposite to the driver's side.

The front of this field of vision opposite to the driver's side may be rounded off with a radius of 2 000 mm (see Figure 11).

The provisions for front mirrors are compulsory for forward-controlled (as defined in Directive 70/156/EEC, Annex I(a), footnote (2)) vehicles of categories $N_2 > 7,5$ t and N_3 .

If vehicles of these categories with other construction characteristics regarding the bodywork cannot fulfil the requirements by using a front mirror, a camera/monitor device shall be used. If either of these options do not provide the adequate field of vision then any other device for indirect vision shall be used. This device must be able to detect an object of 50 cm height and with a diameter of 30 cm within the field defined in Figure 11.

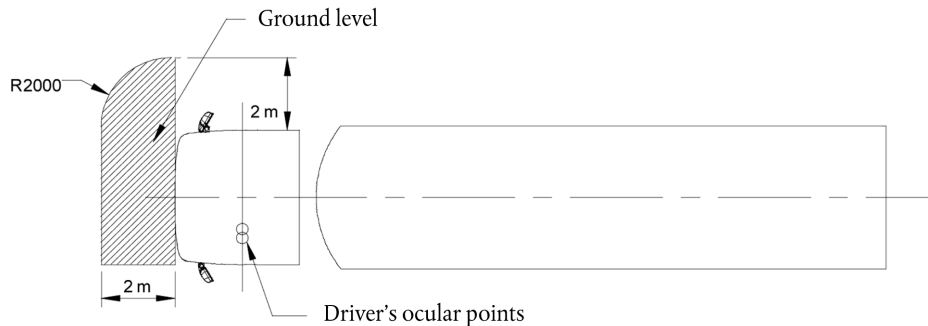

Figure 11: Field of vision of Class VI front mirror

- 5.6.2. However, if the driver can see, taking into account the obstructions by the A-pillars, a straight line 300 mm in front of the vehicle at a height of 1 200 mm above the road surface and which is situated between a longitudinal vertical plane parallel to the longitudinal vertical median plane going through the outermost side of the vehicle at the driver's side and a longitudinal vertical plane parallel to the longitudinal vertical median plane 900 mm outside the outermost side of the vehicle opposite to the driver's side, a front mirror of class VI is not mandatory.
- 5.7. In the case of mirrors consisting of several reflecting surfaces which are either of a different curvature or make an angle with each other, at least one of the reflecting surfaces must provide the field of vision and have the dimensions (see point 2.2.2 of Annex II) specified for the class to which they belong.
- 5.8. Obstructions
- 5.8.1. Interior rear-view mirror (Class I)
- The field of vision may be reduced by the presence of headrest and devices such as, in particular, sun visors, rear windscreen wipers, heating elements and stop lamp of category S3 or by components of bodywork such as window columns of rear split doors, provided that all these devices together do not obscure more than 15 per cent of the prescribed field of vision when projected onto a vertical plane perpendicular to the longitudinal median plane of the vehicle. The degree of obstruction shall be measured with the headrests adjusted to their lowest possible position and with the sun visors folded back.
- 5.8.2. Exterior mirrors (Classes II, III, IV, V and VI)

In the fields of vision specified above, obstruction due to the bodywork and some of its components, such as other mirrors, door handles, outline marker lights, direction indicators and rear bumpers, as well as reflective-surface cleaning components, shall not be taken into account if they are responsible for a total obstruction of less than 10 % of the specified field of vision.

▼B

5.9. Test procedure

The field of vision shall be determined by placing powerful light sources at the ocular points and examining the light reflected on the vertical monitoring screen. Other equivalent methods may be used.

Devices for indirect vision other than mirrors

6. A device for indirect vision shall give such performances that a critical object can be observed within the described field of vision, taking into account the critical perception.
7. Obstruction of the driver's direct view caused by the installation of a device for indirect vision shall be restricted to a minimum.
8. For the determination of the detection distance in case of camera-monitor devices for indirect vision, the procedure of the Appendix to this Annex shall be applied.
9. Installation requirements for the monitor

The viewing direction of the monitor shall roughly be the same direction as the one for the main mirror.
10. Vehicles of category M_2 and M_3 and complete or completed vehicles of categories $N_2 > 7,5$ t and N_3 having a special bodywork for refuse collection may be equipped on the rear part of their bodywork with a device for indirect vision other than a mirror in order to ensure the following field of vision.
- 10.1. The field of vision (see figure 12) must be such that the driver can see at least a flat horizontal portion of the road, which is bounded by:
 - a vertical plane aligned on the furthest rear point of the complete vehicle and perpendicular to the longitudinal vertical median plane of the vehicle;
 - a vertical plane which is parallel to and positioned 2 000 mm to the rear of the previous plane (with respect to the rear of the vehicle);
 - two longitudinal vertical planes defined at the outermost sides of the vehicle and which are parallel to the longitudinal vertical median plane of the vehicle.
- 10.2. If vehicles of these categories cannot fulfil the requirements of point 10.1 by using a camera/monitor device, other devices for indirect vision can be used. In this case the device must be able to detect an object of 50 cm height and with a diameter of 30 cm within the field defined in point 10.1.

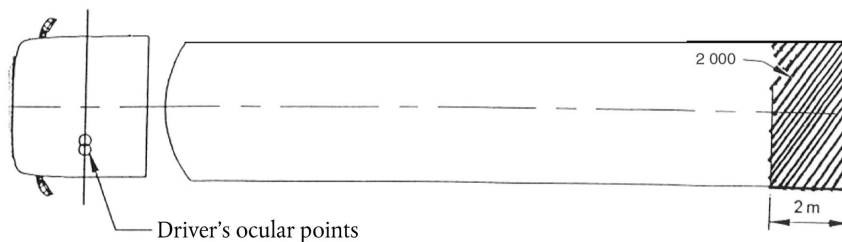

Figure 12: Field of vision of rear devices for indirect vision

▼ B*Appendix***Calculation of the detection distance****1. CAMERA MONITOR DEVICE FOR INDIRECT VISION****1.1. Resolution threshold of a camera**

The resolution threshold of a camera is defined by the formula:

$$\omega_c = 60 \frac{\beta_c}{2N_c}$$

where:

ω_c : resolution threshold of the camera (arc-min)

β_c : angle of vision of the camera (°)

N_c : number of video lines of the camera

The manufacturer shall supply the values for β_c and N_c .

1.2. Determination of the critical viewing distance of the monitor

For a monitor having certain dimensions and properties, a distance to the monitor can be calculated within which the detection distance is dependent only on the performances of the camera. This critical viewing distance $r_{m,c}$ is defined by:

$$r_{m,c} = \frac{H_m}{N_m \cdot 2 \cdot \tan\left(\frac{\omega_{eye}}{2,60}\right)}$$

where:

$r_{m,c}$: critical viewing distance (m)

H_m : height of the monitor image (m)

N_m : number of video lines of the monitor (-)

ω_{eye} : resolution threshold of the observer (minutes of arch)

The number 60 is for conversion from minutes of arches to degrees.

The manufacturer shall supply the values for H_m and N_m .

$\omega_{eye} = 1$

1.3. Determination of the detection distance

1.3.1. Maximum detection distance within the critical viewing distance where, due to the installation, the distance eye-monitor is less than the critical viewing distance, the maximum attainable detection distance shall be defined by:

$$r_d = \frac{D_o}{\tan\left(\frac{f \cdot \omega_c}{60}\right)} = \frac{D_o}{\tan\left(\frac{f \cdot \beta_c}{2 \cdot N_c}\right)}$$

where:

r_d : detection distance [m]

D_o : diameter of the object [m]

f : threshold increasing factor

▼ B

ω_c , β_c and N_c according to item 1.1

$D_0 = 0,8$ m

$f = 8$

- 1.3.2. Detection distance greater than the critical viewing distance. Where, due to the installation, the distance eye-monitor is more than the critical viewing distance, the maximum obtainable detection distance shall be defined:

$$r_d = \frac{D_o}{\tan \left[\frac{f \cdot \beta_c}{2N_c} \cdot \frac{N_m}{0,01524 \cdot D_m} \cdot r_m \cdot \tan \left(\frac{\omega_{eye}}{60} \right) \right]}$$

where:

r_m : viewing distance to the monitor (m)

D_m : diagonal of the monitor screen (inch)

N_m : number of video lines of the monitor (-)

β_c and N_c according to point 1.1

N_m and ω_{eye} according to point 1.2

2. SECONDARY FUNCTIONAL REQUIREMENTS

Based on the installation conditions, a determination shall be made to discover whether the entire device can still satisfy the functional requirements listed in Annex II, especially the glare correction, the maximum and the minimum luminance of the monitor. It shall also be determined the degree to which the glare correction will be addressed and the angle at which sunlight can strike a monitor and these shall be compared to the corresponding measuring results from the system measurements.

This can be based on either a CAD-generated model, a determination of the angles of light for the device when mounted on the relevant vehicle, or by carrying out relevant measurements on the relevant vehicle as described in Annex II, part B, point 3.2.



ANNEX IV

CORRELATION TABLE PROVIDED FOR IN ARTICLE 6

Directive 71/127/EEC as amended	This Directive
—	Article 1
—	Article 2
Article 1	—
Article 2	—
Article 3	—
Article 4	—
Article 5	—
Article 6	—
Article 7	Article 3
Article 8	—
—	Article 4
Article 9	—
Article 10	Article 5
—	Article 6
—	Article 7
Article 11	Article 8
Annex I	Annex I
Appendix 1 to Annex I	Appendix 1 to Annex II
—	Appendix 1 to Annex I
—	Appendix 2 to Annex I
—	Appendix 3 to Annex I
—	Appendix 4 to Annex I
—	Appendix 5 to Annex I
Appendix 2 to Annex I	Appendix 6 to Annex I
Annex II	Annex II, A
—	Annex II, B
Appendix 1 to Annex II	Appendix 1 to Annex II
—	Appendix 2 to Annex II
Appendix 2 to Annex II	—
Appendix 3 to Annex II	Annex I and Appendix 5 to Annex I
Annex III	Appendix 2 to Annex I
—	Annex III
Appendix to Annex III	Appendix to Annex III
—	Appendix 4 to Annex I
—	Annex IV