

This document is meant purely as a documentation tool and the institutions do not assume any liability for its contents

► **B****COUNCIL DIRECTIVE**

**of 26 July 1971**

**on the approximation of the laws of the Member States relating to the braking devices of certain categories of motor vehicles and of their trailers**

(71/320/EEC)

(OJ L 202, 6.9.1971, p. 37)

Amended by:

		Official Journal		
		No	page	date
► <b><u>M1</u></b>	Commission Directive 74/132/EEC of 11 February 1974	L 74	7	19.3.1974
► <b><u>M2</u></b>	Commission Directive 75/524/EEC of 25 July 1975	L 236	3	8.9.1975
► <b><u>M3</u></b>	Commission Directive 79/489/EEC of 18 April 1979	L 128	12	26.5.1979
► <b><u>M4</u></b>	Commission Directive 85/647/EEC of 23 December 1985	L 380	1	31.12.1985
► <b><u>M5</u></b>	Commission Directive 88/194/EEC of 24 March 1988	L 92	47	9.4.1988
► <b><u>M6</u></b>	Commission Directive 91/422/EEC of 15 July 1991	L 233	21	22.8.1991
► <b><u>M7</u></b>	Commission Directive 98/12/EC of 27 January 1998	L 81	1	18.3.1998
► <b><u>M8</u></b>	Commission Directive 2002/78/EC of 1 October 2002	L 267	23	4.10.2002
► <b><u>M9</u></b>	Council Directive 2006/96/EC of 20 November 2006	L 363	81	20.12.2006

Amended by:

► <b><u>A1</u></b>	Act of Accession of Denmark, Ireland and the United Kingdom of Great Britain and Northern Ireland	L 73	14	27.3.1972
► <b><u>A2</u></b>	Act concerning the conditions of accession of the Czech Republic, the Republic of Estonia, the Republic of Cyprus, the Republic of Latvia, the Republic of Lithuania, the Republic of Hungary, the Republic of Malta, the Republic of Poland, the Republic of Slovenia and the Slovak Republic and the adjustments to the Treaties on which the European Union is founded	L 236	33	23.9.2003

Corrected by:

- **C1** Corrigendum, OJ L 999, 1.1.1973, p. 96 (71/320/EEC)
- **C2** Corrigendum, OJ L 247, 23.9.1975, p. 36 (75/524/EEC)
- **C3** Corrigendum, OJ L 275, 2.10.1991, p. 36 (91/422/EEC)

**▼B****COUNCIL DIRECTIVE****of 26 July 1971****on the approximation of the laws of the Member States relating to the braking devices of certain categories of motor vehicles and of their trailers**

(71/320/EEC)

THE COUNCIL OF THE EUROPEAN COMMUNITIES,

Having regard to the Treaty establishing the European Economic Community, and in particular Article 100 thereof;

Having regard to the proposal from the Commission;

Having regard to the Opinion of the European Parliament <sup>(1)</sup>;Having regard to the Opinion of the Economic and Social Committee <sup>(2)</sup>;Whereas the technical requirements which motor vehicles must satisfy pursuant to national laws relate, *inter alia*, to the braking devices of certain categories of motor vehicles and of their trailers;Whereas those requirements differ from one Member State to another; whereas it is therefore necessary that all Member States adopt the same requirements either in addition to or instead of their existing rules, in order, in particular, to allow the EEC type approval procedure which was the subject of the Council Directive of 6 February 1970 on the approximation of the laws of the Member States relating to the type approval of motor vehicles and their trailers to be applied in respect of each type of vehicle <sup>(3)</sup>;

Whereas the harmonised requirements must ensure road safety throughout the whole Community;

HAS ADOPTED THIS DIRECTIVE:

*Article 1***▼M7**

1. For the purposes of this Directive, 'vehicle' means any vehicle as defined in Article 2 of Directive 70/156/EEC.

Vehicle categories are defined in Annex IIA to Directive 70/156/EEC.

**▼B**

2. Articulated category M vehicles made up of two non-separable but articulated units shall be considered to be single vehicles.

**▼M7**<sup>(1)</sup> OJ No C 160, 18.12.1969, p. 7.<sup>(2)</sup> OJ No C 100, 1.8.1969, p. 13.<sup>(3)</sup> OJ No L 42, 23.2.1970, p. 1.

**▼B**

►M7 3. ◀ In the case of category N vehicles, the equipment and fittings of certain special vehicles not intended for the carriage of passengers (such as crane vehicles, workshop vehicles, publicity vehicles) shall be considered to be goods.

**▼M7****▼M4***Article 2*

No Member State may refuse to grant EEC type-approval or national type-approval of a vehicle on grounds relating to its braking device if that vehicle is fitted with the devices specified in ►M7 the relevant Annexes ◀ and if these devices satisfy the requirements set out therein.

**▼A1***Article 2a*

No Member State may refuse or prohibit the sale, registration, entry into service or use of a vehicle on grounds relating to its braking devices if that vehicle is equipped with the braking devices specified in ►M7 the relevant Annexes ◀ and if such braking devices satisfy the requirements set out therein.

**▼B***Article 3*

The Member State which has granted type approval shall take the necessary measures to ensure that it is informed of any modification to a component or characteristic mentioned in item 1.1 of Annex I. The competent authorities of that State shall decide whether the modified prototype should be submitted to fresh tests and whether a fresh report should be drawn up thereon. If such tests reveal failure to comply with the requirements of this Directive, the modification shall not be authorised.

*Article 4*

Pending the entry into force of a separate Directive on the definition of an 'urban bus', such vehicles shall continue to be submitted to the Type II A test described in Annex II where their maximum weight exceeds 10 metric tons.

*Article 5*

The amendments necessary for adjusting the requirements of the Annexes so as to take account of technical progress shall be adopted in accordance with the procedure laid down in Article 13 of ►M7 Council Directive 70/156/EEC ◀ on the type approval of motor vehicles and their trailers.

*Article 6*

1. Member States shall put into force the provisions containing the requirements needed in order to comply with this Directive within eighteen months of its notification and shall forthwith inform the Commission thereof.
2. With effect from 1 October 1974, the provisions of item 2.2.1.4 of Annex I shall also apply to vehicles other than those in category M<sub>3</sub> or category N<sub>3</sub>.

**▼B**

3. Member States shall ensure that the texts of the main provisions of national law which they adopt in the field covered by this Directive are communicated to the Commission.

*Article 7*

This Directive is addressed to the Member States.

▼ M7

## LIST OF ANNEXES

Annex I	Definitions, construction and fitting requirements, application for EC type-approval, granting of EC type-approval, modifications of type and amendments to approvals, conformity of production
Annex II	Braking tests and performance of braking systems  <i>Appendix:</i> Distribution of braking effort among vehicle axles
Annex III	Method of measuring the reaction time for vehicles with compressed-air braking systems  <i>Appendix:</i> Example of a simulator
Annex IV	Energy reservoirs and sources of energy  A: Compressed-air braking systems  B: Vacuum braking systems  C: Hydraulic braking systems with stored energy
Annex V	Spring brakes
Annex VI	Parking braking by mechanical locking of the brake cylinders (lock actuators)
Annex VII	Cases in which Type I and/or II or IIA or Type III tests do not have to be carried out on a vehicle submitted for type-approval  <i>Appendix 1:</i> Alternative procedures for Type I and Type III tests for trailer brakes  <i>Appendix 2:</i> Model reference axle test report form
Annex VIII	Conditions governing the testing of vehicles with inertia (overrun) braking systems  <i>Appendix 1:</i> Explanatory diagrams  <i>Appendix 2:</i> Test report on the control device  <i>Appendix 3:</i> Test report on the brake  <i>Appendix 4:</i> Test report on the compatibility of the control device, the transmission and the brakes
Annex IX	Type-approval documentation  <i>Appendix 1:</i> Type-approval certificate  <i>Appendix 2:</i> Test report  <i>Appendix 3:</i> List of vehicle data for the purpose of approvals pursuant to Annex XV

▼ M7

Annex X	Test conditions for vehicles with anti-lock braking systems
	<i>Appendix 1:</i> Symbols and definitions
	<i>Appendix 2:</i> Utilisation of adhesion
	<i>Appendix 3:</i> Performance on differing adhesion surfaces
	<i>Appendix 4:</i> Method of selection of the low-adhesion surface
Annex XI	Test conditions for trailers with electrical braking systems
	<i>Appendix:</i> Compatibility diagram
Annex XII	Inertia dynamometer test method for brake linings
Annex XIII	Braking and deviation test for vehicles with temporary-use spare wheels/tyres
Annex XIV	Alternative procedure for testing trailer anti-lock braking systems
	<i>Appendix 1:</i> Trailer anti-lock braking system approval report
	<i>Appendix 2:</i> Symbols and definitions
Annex XV	Type-approval of replacement brake lining assemblies as separate technical units
	<i>Appendix 1:</i> Arrangements of the approval mark and approval data
	<i>Appendix 2:</i> Requirements for replacement brake lining assemblies for vehicles of categories M <sub>1</sub> , M <sub>2</sub> and N <sub>1</sub>
	<i>Appendix 3:</i> Requirements for replacement brake lining assemblies for vehicles of categories O <sub>1</sub> and O <sub>2</sub>
	<i>Appendix 4:</i> Determination of friction behaviour by machine testing
Annex XVI	EC type-approval certificate (separate technical units)
Annex XVII	Information document for replacement brake lining assemblies
Annex XVIII	Information document for motor vehicles
Annex XIX	Information document for trailers

## ▼M7

## ANNEX I

**Definitions, construction and fitting requirements, application for EC type-approval, granting of EC type-approval, modifications of type and amendments to approvals, conformity of production**

## 1. DEFINITIONS

For the purpose of this Directive:

- 1.1. *'Type of vehicle with respect to the braking equipment'*  
means vehicles which do not differ significantly in such essential respects as:
- 1.1.1. In the case of motor vehicles
- 1.1.1.1. the vehicle category, as defined in Article 1 of this Directive
- 1.1.1.2. the maximum mass, as defined in point 1.14
- 1.1.1.3. the distribution of mass among the axles
- 1.1.1.4. the maximum design speed
- 1.1.1.5. a different type of braking equipment with particular reference to the presence or otherwise of equipment for braking a trailer
- 1.1.1.6. the number and arrangement of the axles
- 1.1.1.7. the engine type
- 1.1.1.8. the number and ratios of gears
- 1.1.1.9. ratio(s) of rear drive axle(s)
- 1.1.1.10. the tyre dimensions
- 1.1.2. In the case of trailers
- 1.1.2.1. the vehicle category, as defined in Article 1 of this Directive
- 1.1.2.2. the maximum mass, as defined in point 1.14
- 1.1.2.3. the distribution of mass among the axles
- 1.1.2.4. a different type of braking equipment
- 1.1.2.5. the number and arrangement of the axles
- 1.1.2.6. the tyre dimensions.
- 1.2. *'Braking system'*  
means the combination of parts whose function is progressively to reduce the speed of a moving vehicle or to bring it to a halt, or to keep it stationary if it has already halted. These functions are specified in point 2.1.2. The equipment shall consist of the brake control, the transmission and the brake proper.
- 1.3. *'Graduated braking'*  
means braking during which, within the normal range of operation of the equipment, during either the application or the releasing of the brakes,
- the driver can, at any time, increase or reduce the braking force through action of the control,
  - the braking force acts in the same direction as the action on the control (monotonic function),
  - it shall be easily possible to make a sufficiently fine adjustment to the braking force.
- 1.4. *'Control'*  
means the part actuated directly by the driver (or in the case of some trailers, by an assistant) to supply to the transmission the energy required for braking or controlling it. This energy may be the muscular energy of the driver, or energy from another source controlled by the driver, or in appropriate cases the kinetic energy of a trailer, or a combination of these various kinds of energy.

▼ M7

- 1.5. *'Transmission'*
- means the combination of components situated between the control and the brake and connecting the two operationally. The transmission may be mechanical, hydraulic, pneumatic, electrical, or mixed. Where the braking power is derived from or assisted by a source of energy independent of the driver but controlled by him, the reserve of energy in the device shall likewise be regarded as part of the transmission.
- 1.6. *'Brake'* means the part in which the forces opposing the movement of the vehicle develop. It may be a friction brake (when the forces are generated by the friction between two parts of the vehicle moving relatively to one another); an electrical brake (when the forces are generated by electromagnetic action between two parts of the vehicle moving relatively to but not in contact with one another); a fluid brake (when the forces are generated by the action of a fluid situated between two parts of the vehicle moving relatively to one another); or an engine brake (when the forces are derived from a controlled increase in the braking action of the engine transmitted to the wheels).
- 1.7. *'Different types of braking equipment'*
- means equipment which differs in such essential respects as:
- 1.7.1. components having different characteristics
- 1.7.2. a component made of materials having different characteristics or a component different in shape or size
- 1.7.3. a different assembly of the components.
- 1.8. *'Braking system component'*
- means one of the individual parts which, when assembled, constitute the braking equipment.
- 1.9. *'Continuous braking'*
- means the braking of combinations of vehicles through an installation having the following characteristics:
- 1.9.1. a single control which the driver actuates progressively, by a single movement, from his driving seat
- 1.9.2. the energy used for braking the vehicles constituting the combination of vehicles is supplied from the same source (which may be the muscular energy of the driver)
- 1.9.3. the braking installation ensures simultaneous or suitably phased braking of each of the constituent vehicles of the combination, whatever their relative positions.
- 1.10. *'Semi-continuous braking'*
- means the braking of combinations of vehicles through an installation having the following characteristics:
- 1.10.1. a single control which the driver can actuate progressively, by a single movement, from his driving seat
- 1.10.2. the energy used for braking the vehicles constituting the combination of vehicles is supplied from two different sources (one of which may be the muscular energy of the driver)
- 1.10.3. the braking installation ensures simultaneous or suitably phased braking of each of the constituent vehicles of the combination, whatever their relative positions.
- 1.11. *'Automatic braking'*
- means braking of the trailer or trailers occurring automatically in the event of separation of components of the combination of coupled vehicles, including such separation through coupling breakage, without the effectiveness of the remainder of the combination being affected.
- 1.12. *'Inertia or "overrun" braking'*



▼ M7

- means braking by utilising the forces generated by the trailer's moving up on the towing vehicle.
- 1.13. *'Laden vehicle'*
- means, except where otherwise stated, a vehicle laden to its 'maximum mass'.
- 1.14. *'Maximum mass'*
- means the maximum mass stated by the vehicle manufacturer to be technically permissible (this mass may be higher than the 'permissible maximum mass').
- 1.14.1. *'The distribution of mass among the axles'*
- means the distribution of the effect of the gravity on the mass of the vehicle and/or its contents among the axles
- 1.14.2. *'Wheel/axle load'*
- means the vertical static reaction (force) of the road surface in the contact area on the wheel/wheels of the axle
- 1.14.3. *'Maximum stationary wheel/axle load'*
- means the stationary wheel/axle load achieved under the condition of the laden vehicle.
- 1.15. *'Hydraulic braking system with stored energy'*
- means a braking system where energy is supplied by a hydraulic fluid under pressure, stored in one or more accumulators fed from one or more pressure pumps each fitted with a means of limiting the pressure to a maximum value. This value shall be specified by the manufacturer.
- 1.16. *'Category O<sub>3</sub> and O<sub>4</sub> trailer types'*
- 1.16. *'Semi-trailer'*
- means a towed vehicle in which the axle(s) is (are) positioned behind the centre of gravity of the vehicle (when uniformly loaded) and which is equipped with a connecting device permitting horizontal and vertical forces to be transmitted to the towing vehicle.
- 1.16.2. *'Full trailer'*
- means a towed vehicle having at least two axles, and equipped with a towing device which can move vertically (in relation to the trailer) and controls the direction of the front axle(s), but which transmits no significant static load to the towing vehicle.
- 1.16.3. *'Centre-axle trailer'*
- means a towed vehicle equipped with a towing device which cannot move vertically (in relation to the trailer), and in which the axle(s) is (are) positioned close to the centre of gravity of the vehicle (when uniformly loaded) such that only a small static vertical load, not exceeding 10 % of that corresponding to the maximum mass of the trailer or load of 1 000 daN (whichever is the lesser) is transmitted to the towing vehicle.
- 1.17. *'Retarder'<sup>(1)</sup>*
- means an additional braking system having the capability to provide and to maintain a braking effect over a long period of time without a significant reduction in performance. The term 'retarder' covers the complete system including the control device.

<sup>(1)</sup> Until uniform procedures have been agreed to calculate the effects of retarders on the provisions in the Appendix to point 1.1.4.2 of Annex II, this definition does not cover vehicles fitted with regenerative braking systems.

## ▼M7

- 1.17.1. 'Independent retarder'  
means a retarder whose control device is separate from that of the service and other braking systems
- 1.17.2. 'Integrated retarder' <sup>(1)</sup>  
means a retarder whose control device is integrated with that of the service braking system in such a way that both retarder and service braking systems are applied simultaneously or suitably phased by operation of the combined control device.
- 1.17.3. 'Combined retarder'  
means an integrated retarder which in addition has a cut-out device, which allows the combined control to apply the service braking system alone.
- 1.18. '*Inter-urban motor-coach*'  
means a vehicle designed and equipped for inter-urban transport, having no spaces specifically intended for standing passengers, but able to carry for short distances passengers standing in the gangway.
- 1.19. '*Long-distance touring motor-coach*'  
means a vehicle designed and equipped for long-distance journeys, arranged to ensure the comfort of its seated passengers and which does not carry standing passengers.
- 1.20. '*Anti-lock system*'  
See Annex X, point 2.1.
2. CONSTRUCTION AND FITTING REQUIREMENTS
- 2.1. *General*
- 2.1.1. Braking equipment
- 2.1.1.1. The braking equipment shall be so designed, constructed and fitted as to enable the vehicle in normal use, despite the vibration to which it may be subjected, to comply with the undermentioned requirements.
- 2.1.1.2. In particular, the braking equipment shall be so designed, constructed and fitted as to be able to resist the corrosion and ageing phenomena to which it is exposed.
- 2.1.1.3. Brake linings shall not contain asbestos
- 2.1.2. Functions of the braking equipment  
The braking equipment defined in point 1.2 shall fulfil the following functions:
- 2.1.2.1. Service braking system  
The service braking system shall enable the driver to control the movement of the vehicle and to halt it safely, speedily and effectively, whatever its speed and load, on any up or down gradient. It shall be possible to graduate this braking action. The driver shall be able to achieve this braking action from his driving seat without removing his hands from the steering control.
- 2.1.2.2. Secondary braking system  
The secondary braking system shall make it possible to halt the vehicle within a reasonable distance in the event of the failure of the service braking system. It shall be possible to graduate this braking action. The driver shall be able to obtain this braking action from his driving seat while keeping at least one hand on the steering control. For the purpose of these requirements, it is

<sup>(1)</sup> Until uniform procedures have been agreed to calculate the effects of retarders on the provisions in the Appendix to point 1.1.4.2 of Annex II, vehicles equipped with an integrated retarder must also be equipped with an anti-lock system, acting on at least the service brakes of the axle controlled by the retarder, and on the retarder, and complying with the requirements specified in Annex X.

▼ M7

assumed that not more than one failure of the service braking system can occur at one time.

- 2.1.2.3. Parking braking system
- The parking braking system shall enable the vehicle to be held stationary on an up or down gradient even in the absence of the driver, the working parts being then held in the locked position by a purely mechanical device. The driver shall be able to achieve this braking action from his driving seat, subject, in the case of a trailer, to the requirements of point 2.2.2.10.
- The trailer compressed air braking system and the parking braking system of the towing vehicle may be operated simultaneously, provided that the driver is able to check, at any time, that the parking brake performance of the vehicle combination, obtained by the purely mechanical action of the parking braking system, is sufficient.
- 2.1.3. Pneumatic connections between motor vehicles and trailers
- 2.1.3.1. In the case of a braking system operated by compressed air, the pneumatic link with the trailer shall be of the type with two or more lines. However, in all cases, all the requirements of this Directive shall be satisfied by the use of only two lines. shut-off devices which are not automatically actuated shall not be permitted. In the case of articulated vehicle combinations, the flexible hoses shall be a part of the towing vehicle. In all other cases, the flexible hoses shall be a part of the trailer.
- 2.2. *Characteristics of braking systems*
- 2.2.1. Vehicles of categories M and N
- 2.2.1.1. The set of braking systems with which a vehicle is equipped shall satisfy the requirements laid down for the service, secondary and parking braking systems.
- 2.2.1.2. The equipment providing service, secondary and parking braking may have common components, provided that they fulfil the following conditions:
- 2.2.1.2.1. There shall be at least two controls, independent of each other and readily accessible to the driver from his normal driving position. For all categories of vehicles, except  $m_2$  and  $M_3$ , every brake control (excluding a retarder control) shall be designed such that it returns to the fully-off position when released. This requirement shall not apply to a parking brake control (or that part of a combined control) when it is mechanically locked in an applied position.
- 2.2.1.2.2. The control of the service braking system shall be independent of the control of the parking braking system.
- 2.2.1.2.3. Where the service and secondary braking systems have the same control, the effectiveness of the linkage between that control and the various components of the transmission systems shall not be liable to diminish after a certain period of use.
- 2.2.1.2.4. Where the service and secondary braking systems have the same control, the parking braking system shall be so designed that it can be actuated when the vehicle is in motion.
- This provision shall not apply where an auxiliary control permits at least partial actuation of the service braking system, as provided for in Annex II, point 2.1.3.6.
- 2.2.1.2.5. In the event of a breakage of any component other than the brakes (as defined in point 1.6) or the components specified in point 2.2.1.2.7, or of any other failure of the service braking system (malfunction, partial or total exhaustion of an energy reserve), the secondary braking system or that part of the service braking system which is not affected by the failure shall be able to bring the vehicle to a halt in the conditions prescribed for secondary braking.
- 2.2.1.2.6. In particular, where the secondary braking system and the service braking system have a common control and common transmission:

**▼M7**

- 2.2.1.2.6.1. Where the service braking system is actuated by the muscular energy of the driver assisted by one or more energy reserves, the secondary braking performance shall, in the event of failure of that assistance, be capable of being ensured by the muscular energy of the driver assisted by the energy reserves, if any, which are unaffected by the failure, the force applied to the control not exceeding the prescribed maxima.
- 2.2.1.2.6.2. Where the forces for the service braking system and transmission depend exclusively on the use of an energy reserve controlled by the driver, there shall be at least two completely independent energy reserves, each provided with its own independent transmission; each of them may act on the brakes of only two or more wheels so selected as to be capable of ensuring by themselves the prescribed degree of secondary braking performance without endangering the stability of the vehicle during braking; in addition, each of these energy reserves shall be fitted with a warning device as defined in point 2.2.1.13.
- 2.2.1.2.7. Certain parts, such as the pedal and its bearing, the master cylinder and its piston(s) (hydraulic systems), the control valve (hydraulic and/or pneumatic systems), the linkage between the pedal and the master cylinder or the control valve, the brake cylinders and their pistons (hydraulic and/or pneumatic systems), and the lever-and-cam assemblies of brakes, shall not be regarded as liable to breakage if they are amply dimensioned, are readily accessible for maintenance, and exhibit safety features at least equal to those prescribed for other essential components (such as the steering linkage) of the vehicle. Where the failure of any such part would make it impossible to brake the vehicle with a performance at least equal to that prescribed for the secondary braking system that part shall be made of metal or of a material with equivalent characteristics and shall not be subject to significant distortion in the normal operation of the braking equipment.
- 2.2.1.3. Where there are separate controls for the service and secondary braking systems, simultaneous actuation of the two controls shall not render both the service and secondary braking systems inoperative, either when both braking systems are in good working order or when one of them is faulty.
- 2.2.1.4. In the event of failure in a part of the transmission of the service braking system, the following conditions shall be met:
- 2.2.1.4.1. A sufficient number of wheels shall still brake by actuation of the service braking system control, whatever the vehicle load.
- 2.2.1.4.2. These wheels shall be so selected that the residual performance of the service braking system satisfies the requirements laid down in point 2.1.4 of Annex II.
- 2.2.1.4.3. However, the above requirements shall not apply to towing vehicles for semi-trailers when the transmission of the service braking system of the semi-trailer is independent of that of the towing vehicle.
- 2.2.1.5. Where use is made of energy other than the muscular energy of the driver, there need not be more than one source of such other energy (hydraulic pump, air compressor, etc.), but the means by which the device constituting that source is driven shall be as safe as practicable.
- 2.2.1.5.1. In the event of failure in any part of the transmission of a vehicle's braking systems, the supply to the part not affected by the failure shall continue to be ensured where this is required for the purpose of halting the vehicle with the degree of effectiveness prescribed for residual and/or for secondary braking. This condition shall be satisfied by means of devices which can be easily actuated when the vehicle is stationary, or by automatic means.
- 2.2.1.5.2. Furthermore, storage devices located down-circuit of this device are such that in the event of a failure in the energy supply, after four full-stroke actuations of the service braking system control under the conditions prescribed in point 1.2 of Annex IV, sections A and B, it is still possible to halt the vehicle at the fifth appli-

## ▼M7

- cation with the degree of effectiveness prescribed for secondary braking.
- 2.2.1.5.3. However, for hydraulic braking systems with stored energy, these provisions can be considered to have been satisfied, provided that the requirements of point 1.2.2 of Annex IV, section C, are satisfied.
- 2.2.1.6. The requirements of points 2.2.1.2, 2.2.1.4 and 2.2.1.5 shall be satisfied without the use of any automatic device of a kind such that its ineffectiveness might pass unnoticed because the parts which are normally in an 'at rest' position are actuated only in the event of failure of the braking system.
- 2.2.1.7. The service braking system shall act on all the wheels on the vehicle.
- 2.2.1.8. The action of the service braking system shall be appropriately distributed among the axles. In the case of vehicles with more than two axles, in order to avoid wheel-locking or glazing of the brake linings, the brake force on certain axles may be reduced to zero automatically when carrying a much reduced load, provided that the vehicle meets all the performance requirements prescribed in Annex II.
- 2.2.1.9. The action of the service braking system shall be distributed between the wheels of the same axle symmetrically in relation to the longitudinal median plane of the vehicle.
- 2.2.1.10. The service braking system and the parking braking system shall act on braking surfaces permanently connected to the wheels through components of adequate strength. It shall not be possible to disconnect a braking surface from the wheels; however, in the case of the service braking system and secondary braking system, such disconnection of the braking surfaces shall be permitted provided that it is only momentary, for instance during a change of gear, and that both the service braking system and the secondary braking system continue to operate with the prescribed degree of effectiveness. In addition, any such disconnection shall be permitted in the case of the parking braking system, provided that it is controlled exclusively by the driver from his driving seat by a system which cannot be actuated by a leak <sup>(1)</sup>.
- 2.2.1.11. Wear of the brakes shall be easily compensated by means of a system of manual or automatic adjustment. In addition, the control and the components of the transmission and of the brakes shall possess a reserve of travel and, if necessary, suitable means of compensation such that, when the brakes become heated or when the brake linings have reached a certain degree of wear, effective braking shall be ensured without immediate adjustment being necessary.
- 2.2.1.11.1. Wear adjustment shall be automatic for the service brakes. However, the fitting of automatic adjustment devices shall be optional for off-road vehicles of categories N<sub>2</sub> and N<sub>3</sub>, and for rear brakes of vehicles of categories M<sub>1</sub> and N<sub>1</sub>. Automatic wear adjustment devices shall be such that after heating followed by cooling of the brakes, effective braking is still ensured. In particular, the vehicle shall remain capable of normal running after the tests conducted in accordance with Annex II, point 1.3 (Type I test) and Annex II, point 1.4 (Type II test), or point 1.6 (Type III test).
- 2.2.1.12. It shall be possible to easily check this wear on service brake linings from the outside or underside of the vehicle, utilising only the tools or equipment normally supplied with the vehicle; for instance, by the provision of appropriate inspection holes or by some other means. Alternatively, acoustical or optical devices warning the driver at his driving position when lining replacement is necessary are acceptable. The removal of front and/or rear

<sup>(1)</sup> This point must be interpreted in the following way: the performance of the service and secondary braking systems must remain within the limits prescribed in the Directive, even during momentary disconnection.

## ▼M7

- wheels shall be permitted for this purpose on category M<sub>1</sub> and N<sub>1</sub> vehicles only.
- 2.2.1.12. In hydraulic braking systems:
- 2.2.1.12.1. The filling ports of the fluid reservoirs shall be readily accessible; in addition, the containers of reserve fluid shall be so made that the level of the reserve fluid can be easily checked without the containers having to be opened. Where this last condition is not fulfilled, a warning light shall indicate to the driver when the reserve fluid falls to a level liable to cause a failure of the braking system. The driver shall be able to check easily whether the light is functioning properly.
- 2.2.1.12.2. The failure of a part of a hydraulic transmission system shall be signalled to the driver by a device comprising a red tell-tale lamp lighting up not later than on actuation of the control and remaining lit as long as the failure persists and the ignition (start) switch is in the 'on' (run) position. However a device comprising a red tell-tale lamp lighting up when the level of the fluid in its reservoirs falls below the value specified by the manufacturer shall be admissible. The tell-tale lamp shall be visible even by daylight; the satisfactory condition of the lamp shall be easily verifiable by the driver from the driver's seat. The failure of a component of the device shall not entail total loss of effectiveness of the braking system in question.
- 2.2.1.12.3. The type of fluid to be used in the hydraulic transmission of braking systems should be identified in accordance with ISO standard 9128-1987. The relevant symbol according to Figure 1 or 2 shall be affixed in a visible position in indelible form within 100 mm of the filling ports of the fluid reservoirs, additional information may be provided by the manufacturers.
- 2.2.1.13. Any vehicle fitted with a service braking system actuated by an energy reservoir shall, where the prescribed secondary braking performance cannot be obtained by means of this braking system without the use of stored energy, be provided with a warning device — in addition to a pressure gauge where fitted — giving an optical or acoustic signal when the stored energy in any part of the system falls to a value at which, without recharging of the reservoir and irrespective of the loading conditions of the vehicle, it shall be possible to apply the service braking system control a fifth time after four full-stroke actuations and obtain the prescribed secondary braking performance (without faults in the service-brake transmission and with the brakes adjusted as closely as possible). The warning device shall be directly and permanently connected to the circuit. When the engine is running under normal operating conditions and there are no faults in the braking system, the warning device shall give no signal except during the time required for charging the energy reservoir(s) after start-up of the engine.
- 2.2.1.13.1. However, in the case of vehicles which are only considered to comply with the requirements of point 2.2.1.5.1 by virtue of meeting the requirements of point 1.2.2 of Annex IV, section C, the alarm device shall consist of an acoustic signal in addition to an optical signal. These devices need not operate simultaneously, provided that each of them meets the above requirements and the acoustic signal is not actuated before the optical signal.
- 2.2.1.13.2. This acoustic device may be rendered inoperative while the parking brake is applied and/or, at the choice of the manufacturer, in the case of automatic transmission the selector in the 'park' position.
- 2.2.1.14. Without prejudice to the requirements of point 2.1.2.3, where the use of an auxiliary energy source is essential for the operation of a braking system, the energy reserve shall be such as to ensure that, should the engine stop, or in the event of a failure of the means by which the energy source is driven, the braking performance remains sufficient to bring the vehicle to a halt in the prescribed conditions. In addition, if the muscular energy applied by the driver to the parking braking system is reinforced by some aid, the actuation of the parking braking system shall be ensured in the

▼ M7

event of failure of that aid, if necessary by using a reserve of energy independent of that normally supplying such aid. This reserve of energy may be that intended for the service braking system. The expression 'actuation' also covers the action of releasing.

- 2.2.1.15. In the case of a motor vehicle to which the coupling of a trailer equipped with a brake controlled by the driver of the towing vehicle is authorised, the service braking system of the towing vehicle shall be fitted with a device so designed that if the trailer braking system should fail, or the air supply line (or such other type of connection as may be adopted) between the towing vehicle and trailer should break, it will still be possible to brake the towing vehicle with the effectiveness prescribed for the secondary braking system; it is accordingly prescribed, in particular, that this device be fitted to the towing vehicle <sup>(1)</sup>.
- 2.2.1.16. The auxiliary equipment shall be supplied with energy in such a way that during its operation the prescribed performance values can be reached and that even in the event of damage to the source of energy, the operation of the auxiliary equipment cannot cause the reserves of energy feeding the braking systems to fall below the level indicated in point 2.2.1.13.
- 2.2.1.17. Where a trailer belongs to category O<sub>3</sub> or O<sub>4</sub>, the service braking system must be of a continuous or semi-continuous type.
- 2.2.1.18. In the case of a vehicle authorised to tow a category O<sub>3</sub> or O<sub>4</sub> trailer, the braking system shall satisfy the following conditions:
- 2.2.1.18.1. When the secondary braking system of the towing vehicle is actuated, there shall also be a graduated braking action on the trailer.
- 2.2.1.18.2. Should the service braking system of the towing vehicle fail, and if this system is made up of at least two independent sections, the section or sections not affected by this failure must be able partially or fully to actuate the trailer brakes. It shall be possible to graduate this braking action; if this operation is achieved by a valve which is normally at rest, then such a valve may only be incorporated if its correct functioning can easily be checked by the driver, either from within the cab or from outside the vehicle, without the use of tools.
- 2.2.1.18.3. In the case of a fracture or leak in one of the air supply lines (or in such other type of connection as may be adopted), it shall nevertheless be possible for the driver to fully or partially actuate the trailer brakes, by means either of the service braking system control or of the secondary braking system control or of the parking braking system control, unless the fracture or leak automatically causes the trailer to be braked with the performance prescribed in point 2.2.3 of Annex II.
- 2.2.1.18.4. In the case of a two-line air supply system, the requirement in point 2.2.1.18.3 shall be considered to be met if the following conditions are fulfilled:
- 2.2.1.18.4.1. When the designated brake control of the controls mentioned in point 2.2.1.18.3 is fully actuated, the pressure in the supply line shall fall to 1,5 bar within the following two seconds.
- 2.2.1.18.4.2. When the supply line is evacuated at the rate of at least 1 bar/s, the automatic braking of the trailer shall start to operate before the pressure in the supply line falls to 2 bar.
- 2.2.1.19. The following vehicle types shall satisfy the Type IIA test described in point 1.5 of Annex II and not the Type II test described in point 1.4 of that Annex:
- inter-urban motor-coaches and long-distance touring motor-coaches of category M<sub>3</sub>

<sup>(1)</sup> This point is to be interpreted in the following way: it is essential, in all cases, that the service braking system should be fitted with a device (for instance a limiting valve) ensuring that the vehicle can still be braked by the service braking system, but with a performance prescribed for the secondary braking system.

▼ M7

— and motor vehicles of category N<sub>3</sub> authorised to tow trailers of category O<sub>4</sub>.

Where the maximum mass of this vehicle exceeds 26 000 kilograms, the test mass shall be limited to 26 000 kilograms, or in the case where the unladen vehicle mass exceeds the mass of 26 000 kilograms, this mass is to be taken into account by calculation.

- 2.2.1.20. In the case of a motor vehicle equipped to tow a trailer with electric braking systems, the following requirements shall be met:
- 2.2.1.20.1. The power supply (generator and battery) of the motor vehicle shall have a sufficient capacity to provide the current for an electrical braking system. With the engine running at the idling speed recommended by the manufacturer and all electrical devices supplied by the manufacturer as standard equipment of the vehicle switched on, the voltage in the electrical lines, at maximum current consumption of the electrical braking system (15 A), shall not fall below the value of 9,6 V measured at the connection. The electrical lines must not be capable of short-circuiting even when overloaded.
- 2.2.1.20.2. In the event of a failure in the towing vehicle's service braking system, where that system consists of at least two independent units, the unit or units not affected by the failure shall be capable of partially or fully actuating the brakes of the trailer.
- 2.2.1.20.3. The use of the stop-light switch and circuit for actuating the electrical braking system is permissible only if the actuating line is connected in parallel with the stop-light and the existing stop-light switch and circuit are capable of taking the extra load.
- 2.2.1.21. In the case of a pneumatic service braking system comprising two or more independent sections, any leakage between those sections at or downstream of the control shall be continuously vented to atmosphere.
- 2.2.1.22. Motor vehicles of categories M<sub>2</sub>, M<sub>3</sub>, N<sub>2</sub> and N<sub>3</sub> with not more than four axles shall be equipped with anti-lock systems of category 1 in accordance with the requirements of Annex X.
- 2.2.1.23. If motor vehicles not mentioned in point 2.2.1.22 are fitted with anti-lock systems, they shall comply with the requirements of Annex X.
- 2.2.1.24. In the case of a motor vehicle authorised to tow a trailer of category O<sub>3</sub> or O<sub>4</sub> the service braking system of the trailer may only be operated in conjunction with the service, secondary or parking braking system of the towing vehicle.
- 2.2.1.25. Motor vehicles authorised to tow a trailer equipped with an anti-lock system, with the exception of vehicles of categories M<sub>1</sub> and N<sub>1</sub>, shall be fitted with a separate optical warning signal for the anti-lock system of the trailer, meeting the requirements of points 4.1, 4.2 and 4.3 of Annex X. They shall also be equipped with a special electric connector for the anti-lock systems of trailers, in accordance with Annex X, point 4.4 of this Directive.
- 2.2.1.26. Motor vehicles of category M<sub>1</sub> may be equipped with temporary-use spare wheels/tyres, provided they meet the requirements of Annex XIII.
- 2.2.2. Vehicles of category O
- 2.2.2.1. Trailers of category O<sub>1</sub> need not be fitted with a service braking system; however, if trailers of this category are equipped with a service braking system, this shall comply with the same requirements as those of category O<sub>2</sub>.
- 2.2.2.2. Every trailer of category O<sub>2</sub> shall be fitted with a service braking system either of the continuous or semi-continuous type or of the inertia (overrun) type. The latter type shall be authorised only for trailers other than semi-trailers. However, electrical braking systems conforming to the requirements of Annex XI shall be permitted.



## ▼M7

- 2.2.2.3. Every trailer of category O<sub>3</sub> or O<sub>4</sub> shall be fitted with a service braking system of the continuous or semi-continuous type.
- 2.2.2.4. The service braking system shall act on all the wheels of the trailer.
- 2.2.2.5. The action of the service braking system shall be suitably distributed among the axles.
- 2.2.2.6. The action of every braking system shall be distributed between the wheels of each axle symmetrically in relation to the longitudinal median plane of the vehicle.
- 2.2.2.7. The braking surfaces required to attain the prescribed degree of effectiveness shall be in constant contact with the wheels, either rigidly or through components not liable to failure.
- 2.2.2.8. Wear of the brakes shall be easily compensated by a system of manual or automatic adjustment. In addition, the control and the components of the transmission and of the brakes shall possess a reserve of travel and if necessary, suitable means of compensation such that, when the brakes become heated or when the brake linings have reached a certain degree of wear, effective braking shall be ensured without immediate adjustment being necessary.
- 2.2.2.8.1. Wear adjustment shall be automatic for the service brakes. However, the fitting of automatic adjustment devices is optional for vehicles of categories O<sub>1</sub> and O<sub>2</sub>. Automatic wear adjustment devices shall be such that after heating followed by cooling of the brakes, effective braking is still ensured.
- In particular, the vehicle shall remain capable of normal running after the tests conducted in accordance with Annex II, point 1.3 (Type I test) and Annex II, point 1.6 (Type III test).
- 2.2.2.8.2. It shall be possible to easily check the wear on service brake linings from the outside or underside of the vehicle, utilising only the tools or equipment normally supplied with the vehicle; for instance, by the provision of appropriate inspection holes or by some other means.
- 2.2.2.9. The braking systems shall be such that the trailer is stopped automatically if the coupling separates while the trailer is in motion. However, this requirement does not apply to trailers with a maximum mass not exceeding 1,5 metric tons provided that the trailers are fitted, in addition to the main coupling, with a secondary coupling (chain, cable, etc.), which, in the event of separation of the main coupling, can stop the drawbar from touching the ground and provide some residual steering action on the trailer.
- 2.2.2.10. On every trailer which is required to be fitted with a service braking system, parking braking shall be ensured even when the trailer is separated from the towing vehicle. It shall be possible for a person standing on the ground to actuate the parking braking system; however, in the case of a trailer used for the carriage of passengers, it shall be possible to actuate this braking system from inside the trailer. The expression 'actuate' also covers the action of releasing.
- 2.2.2.11. If the trailer is fitted with a device enabling compressed-air actuation of the braking system, other than the parking braking system, to be cut out, the device shall be so designed and constructed that is positively restored to the 'at rest' position not later than on the resumption of the supply of compressed air to the trailer.
- 2.2.2.12. Trailers of categories O<sub>3</sub> and O<sub>4</sub> fitted with a two-line air supply system shall satisfy the conditions specified in point 2.2.1.18.3.
- 2.2.2.13. Trailers of categories O<sub>3</sub> and O<sub>4</sub> shall be equipped with anti-lock systems in accordance with the requirements of Annex X.
- 2.2.2.14. If trailers not mentioned in point 2.2.2.13 are fitted with anti-lock systems, they shall comply with the requirements of Annex X.
- 2.2.2.15. The auxiliary equipment shall be supplied with energy in such a way that during its operation, the service braking energy storage

**▼M7**

device(s) shall be maintained at a pressure of at least 80 % of the minimum towing vehicle supply pressure as prescribed in point 3.1.2.2 of the Appendix to Annex II.

- 2.2.2.15.1 In the event of a break or leak from the auxiliary equipment or any associated pipes, the sum of the forces exerted at the periphery of the braked wheels shall be at least 80 % of the value prescribed for the trailer concerned in 2.2.1.2.1 of Annex II. However, where such breakage or leakage affects the control signal to a special device as referred to in point 6 of the Appendix to Annex II, the performance requirements of that point shall apply.

**▼M8**

- 2.3. *Brake linings and brake lining assemblies*
- 2.3.1. Brake lining assemblies used to replace components at the end of their working life shall comply with the requirements in Annex XV for those categories of vehicles specified in point 1.1 of Annex XV.
- 2.3.2. However, where the brake lining assemblies are of a type covered by point 1.2 of the Addendum to Annex IX and are intended for fitment to a vehicle/axle/brake to which the relevant type approval document refers, they do not need to comply with Annex XV provided they fulfil the requirements in points 2.3.2.1 to 2.3.2.2.
- 2.3.2.1. *Marking*
- The brake lining assemblies shall bear at least the following identifications:
- 2.3.2.1.1. Vehicle and/or component manufacturer's name or trade mark;
- 2.3.2.1.2. Make and identifying part number of the brake lining assembly as recorded in the information mentioned in point 2.3.4.
- 2.3.2.2. *Packaging*
- The brake lining assemblies shall be packaged in axle sets in accordance with the following requirements:
- 2.3.2.2.1. Each package shall be sealed and constructed to show previous opening;
- 2.3.2.2.2. Each package shall display at least:
- 2.3.2.2.2.1. The quantity of brake lining assemblies contained;
- 2.3.2.2.2.2. Vehicle and/or component manufacturer's name or trade mark;
- 2.3.2.2.2.3. Make and identifying part number(s) of the brake lining assembly (assemblies), as recorded in the information mentioned in point 2.3.4.
- 2.3.2.2.2.4. Part number(s) of the axle set, as recorded in the information mentioned in point 2.3.4.
- 2.3.2.2.2.5. Sufficient information for the customer to identify the vehicles/axles/brakes for which the contents are approved.
- 2.3.2.2.3. Each package shall contain fitting instructions with particular reference to ancillary parts and stating that the brake lining assemblies must be replaced in axle sets.
- 2.3.2.2.3.1. The fitting instructions may alternatively be supplied in a separate transparent container together with the brake lining assembly package.
- 2.3.3. Brake lining assemblies supplied to vehicle manufacturers exclusively for use during the assembly of vehicles do not need to comply with the requirements in points 2.3.2.1 and 2.3.2.2 above.
- 2.3.4. The vehicle manufacturer shall provide to the technical service and/or approval authority the necessary information in electronic format which makes the link between the relevant part numbers and the type approval documentation.

This information shall contain:

- make(s) and type(s) of vehicle

**▼M8**

- make(s) and type(s) of brake lining
- part number(s) and quantity of the brake lining assemblies
- part number(s) of the axle set
- type approval number of the braking system of the relevant vehicle type(s).

**▼M7**

3. APPLICATION FOR EC TYPE-APPROVAL
  - 3.1. The application for EC type-approval, pursuant to Article 3(4) of Directive 70/156/EEC, of a vehicle-type with regard to the braking equipment shall be submitted by the vehicle manufacturer.
  - 3.2. A model for the information document is given in Annex XVIII in the case of motor vehicles or in Annex XIX in the case of trailers with other than inertia (overrun) braking systems.
  - 3.3. A vehicle representative of the vehicle-type to be approved shall be submitted to the technical service responsible for conducting the approval tests.
4. GRANTING OF EC TYPE-APPROVAL
  - 4.1. If the relevant documents are complied with, EC type-approval pursuant to Article 3(4) of Directive 70/156/EEC shall be granted.
  - 4.2. A model for the type-approval certificate is given in Annex IX, Appendix 1.
  - 4.3. An approval number in accordance with Annex VII to Directive 70/156/EEC shall be assigned to each type of vehicle approved. The same Member State must not assign the same number to another type of vehicle.
5. MODIFICATIONS OF THE TYPE-AND AMENDMENTS TO APPROVALS
  - 5.1. In the case of modifications of the type approved pursuant to this Directive, the provisions of Article 5 of Directive 70/156/EEC shall apply.
6. CONFORMITY OF PRODUCTION
  - 6.1. Measures to ensure the conformity of production shall be taken in accordance with the provisions laid down in Article 10 of Directive 70/156/EEC.

▼ M7

## ANNEX II

**Braking Tests and performance of braking systems**

## 1. BRAKING TESTS

1.1. *General*

1.1.1. The performance prescribed for braking systems shall be based on the stopping distance and/or the mean fully developed deceleration. The performance of a braking system shall be determined by measuring the stopping distance in relation to the initial speed of the vehicle and/or by measuring the mean fully developed deceleration during the test.

1.1.2. The stopping distance shall be the distance covered by the vehicle from the moment when the driver begins to actuate the control of the braking system until the moment when the vehicle stops; the initial vehicle speed ( $v_1$ ) shall be the speed at the moment when the driver begins to actuate the control of the braking system; the initial speed shall not be less than 98 % of the prescribed speed for the test in question. The mean fully developed deceleration  $d_m$  shall be calculated as the deceleration averaged with respect to distance over the interval  $v_b$  to  $v_e$  according to the following formula:

$$d_m = \frac{v_b^2 - v_e^2}{25,92 (s_e - s_b)} \text{ m/s}^2$$

where

$V_1$  = as defined above

$V_b$  = vehicle speed at 0,8  $V_1$  km/h

$V_e$  = vehicle speed at 0,1  $V_1$  km/h

$S_b$  = distance travelled between  $V_1$  and  $V_b$  in metres

$S_e$  = distance travelled between  $V_1$  and  $V_e$  in metres.

The speed and distance shall be determined using instrumentation having an accuracy of  $\pm 1$  % at the prescribed speed for the test. The  $d_m$  may be determined by other methods than the measurement of speed and distance; in this case, the accuracy of the  $d_m$  shall be within  $\pm 3$  %.

1.1.3. For the type-approval of any vehicle, the braking performance shall be measured during road tests conducted in the following conditions:

1.1.3.1. The vehicle's condition as regards mass shall be as prescribed for each type of test and be specified in the test report, (Annex IX, Appendix 2).

1.1.3.2. The test shall be carried out at the speeds prescribed for each type of test. Where a vehicle is so constructed that its maximum speed is lower than that prescribed for a test, the test shall be performed at the maximum speed of the vehicle.

1.1.3.3. During the tests, the force applied to the control of the braking system in order to obtain the prescribed performance shall not exceed the maximum force laid down for the test vehicle's category.

1.1.3.4. Without prejudice to the requirements contained in point 1.1.4.2, the road shall possess a surface having good adhesion.

1.1.3.5. The tests shall be performed when there is no wind liable to affect the results.

1.1.3.6. At the start of the tests the tyres shall be cold and at the pressure prescribed for the load actually borne by the wheels when the vehicle is stationary.

1.1.3.7. The prescribed performance shall be obtained without locking of the wheels, without deviation of the vehicle from its course, and

▼ M7

- without abnormal vibration. Wheel-locking is permitted where specifically mentioned.
- 1.1.4. Behaviour of the vehicle during braking
- 1.1.4.1. In braking tests, and in particular in those at high speed, the general behaviour of the vehicle during braking shall be checked.
- 1.1.4.2. The braking behaviour of vehicles of categories M, N, O<sub>3</sub> and O<sub>4</sub> on a road surface having reduced adhesion shall fulfil the conditions laid down in the Appendix to this Annex.
- 1.2. *Type O test* (ordinary performance test with brakes cold)
- 1.2.1. General
- 1.2.1.1. The brakes shall be cold. A brake is deemed to be cold when the temperature measured on the disc or on the outside of the drum is below 100 °C.
- 1.2.1.2. The test shall be conducted in the following conditions:
- 1.2.1.2.1. The vehicle shall be laden, the distribution of its mass among the axles being that stated by the manufacturer. Where provision is made for several arrangements of the load on the axles the distribution of the maximum mass among the axles shall be such that the load on each axle is proportional to the maximum permissible load for each axle; in the case of tractive units for semi-trailers, the load may be re-positioned approximately half-way between the kingpin position resulting from the above loading conditions and the centreline of the rear axle(s).
- 1.2.1.2.2. Every test shall be repeated on the unladen vehicle. In the case of a motor vehicle there may be, in addition to the driver, a second person on the front seat who is responsible for noting the results of the test. In the case of a motor vehicle designed to tow a semi-trailer, the unladen tests shall be conducted with the tractive unit only, without its trailer, but carrying a load representing the fifth wheel. It will also include a load representing a spare wheel, if this is included in the standard specification of the vehicle. In the case of a vehicle presented as a bare chassis-cab, a supplementary load may be added to simulate the mass of the body, not exceeding the minimum mass declared by the manufacturer in Annex XVIII.
- 1.2.1.2.3. The limits prescribed for minimum performance, both for tests with the vehicle unladen and for tests with the vehicle laden, are those laid down hereunder for each category of vehicle, the vehicle shall satisfy both the prescribed stopping distance and the prescribed mean fully developed deceleration for the relevant vehicle category, but it may not be necessary to actually measure both parameters.
- 1.2.1.2.4. The road shall be level.
- 1.2.2. *Type O test with engine disconnected*
- 1.2.2.1. The test shall be carried out at the speed prescribed for the category to which the vehicle belongs, the figures prescribed in this connection being subject to a certain margin of tolerance. The minimum performance prescribed for each category shall be attained.
- 1.2.3. *Type O test with engine connected*
- 1.2.3.1. Apart from the test prescribed in point 1.2.2, additional tests shall be carried out at various speeds with the engine connected, the lowest being equal to 30 % of the maximum speed of the vehicle and the highest being equal to 80 % of that speed. The maximum practical performance figures shall be measured and the behaviour of the vehicle shall be recorded in the test report. Tractive units for semi-trailers, artificially loaded to simulate the effects of a laden semi-trailer, shall not be tested beyond 80 km/h.
- 1.2.3.2. Further tests shall be carried out with the engine connected, from the speed prescribed for the category to which the vehicle belongs. The minimum performance prescribed for each category shall be attained. Tractive units for semi-trailers, artificially loaded to

▼ M7

simulate the effects of a laden semi-trailer, shall not be tested beyond 80 km/h.

1.2.4. Type 0 test for vehicle of category O equipped with compressed-air brakes

1.2.4.1. The braking performance of the trailer can be calculated either from the braking rate of the towing vehicle plus the trailer and the measured thrust on the coupling or, in certain cases, from the braking rate of the towing vehicle plus the trailer with only the trailer being braked. The engine of the towing vehicle shall be disconnected during the braking test. In the case where only the trailer is braked, to take account of the extra mass being retarded, the performance will be taken to be the mean fully developed deceleration.

1.2.4.2. With the exception of cases according to points 1.2.4.3 and 1.2.4.4, it is necessary for the determination of the braking rate of the trailer to measure the braking rate of the towing vehicle plus the trailer and the thrust on the coupling. The towing vehicle shall meet the requirements laid down in the Appendix to point 1.1.4.2 of Annex II with regard to the relation between the ratio

$$\frac{TM}{PM}$$

and the pressure  $p_m$ . The braking rate of the trailer shall be calculated according to the following formula:

$$Z_R = Z_{R+M} + \frac{D}{P_R}$$

where:

$Z_R$  = braking rate of the trailer

$Z_{R+M}$  = braking rate of the towing vehicle plus the trailer

$D$  = thrust on the coupling

(tractive force  $D > 0$ )

(compressive force  $D < 0$ )

$P_R$  = total normal static reaction between road surface and wheels of the trailer

1.2.4.3. If a trailer has a continuous or semi-continuous braking system where the pressure in the brake actuators does not change during braking despite the dynamic axle load shifting, and in the case of semi-trailers, the trailer alone may be braked. The braking rate of the trailer shall be calculated according to the following formula:

$$Z_R = (Z_{R+M} - R) \times \frac{(P_M + P_R)}{P_R} + R$$

where:

$R$  = rolling resistance value = 0,01

$P_M$  = total normal static reaction between road surface and wheels of towing vehicles for trailers

1.2.4.4. Alternatively, the evaluation of the braking rate of the trailer may be done by braking the trailer alone. In this case the pressure used shall be the same as that measured in the brake actuators during the braking of the combination.

1.3. *Type I test (fade test)*

1.3.1. With repeated braking

1.3.1.1. The service braking system of all motor vehicles shall be tested by successively applying and releasing the brakes a number of times, the vehicle being laden, in accordance with the conditions shown in the following table:

▼ **M7**

Category of vehicle	Conditions			
	$V_1$ km/h	$V_2$ km/h	$\Delta t$ (s)	n
M <sub>1</sub>	80 % $V_{\max}$ $\leq 120$	$\frac{1}{2} V_1$	45	15
M <sub>2</sub>	80 % $V_{\max}$ $\leq 100$	$\frac{1}{2} V_1$	55	15
M <sub>3</sub>	80 % $V_{\max}$ $\leq 60$	$\frac{1}{2} V_1$	60	20
N <sub>1</sub>	80 % $V_{\max}$ $\leq 120$	$\frac{1}{2} V_1$	55	15
N <sub>2</sub>	80 % $V_{\max}$ $\leq 60$	$\frac{1}{2} V_1$	60	20
N <sub>3</sub>	80 % $V_{\max}$ $\leq 60$	$\frac{1}{2} V_1$	60	20

where:

$V_1$  = refer to point 1.1.2

$V_2$  = speed at end of braking

$V_{\max}$  = maximum speed of the vehicle

n = number of times brakes applied

$\Delta t$  = duration of a braking cycle (time elapsing between the initiation of one brake application and the initiation of the next).

- 1.3.1.2. If the characteristics of the vehicle do not allow for the period of time prescribed for  $\Delta t$ , the duration may be increased; in any event, in addition to the time necessary for braking and accelerating the vehicle, a period of 10 seconds shall be allowed in each cycle for stabilising the speed  $v_1$ .
- 1.3.1.3. In these tests, the force applied to the control shall be so adjusted as to attain a mean fully developed deceleration of  $3 \text{ m/s}^2$  at the first application of the brakes. This force shall remain constant throughout the succeeding brake applications.
- 1.3.1.4. During brake applications the highest gear ratio (excluding overdrive, etc.) shall be continuously engaged.
- 1.3.1.5. For regaining speed after braking, the gearbox shall be used in such a way as to attain the speed  $v_1$  in the shortest possible time (maximum acceleration allowed by the engine and gearbox).
- 1.3.2. **With continuous braking**
- 1.3.2.1. The service braking system of trailers of categories O<sub>2</sub> and O<sub>3</sub> shall be tested in such a manner that, the vehicle being laden, the energy input to the brakes shall be equivalent to that recorded in the same period of time with a laden vehicle driven at a steady speed of 40 km/h on a 7 % down gradient for a distance of 1,7 km.
- 1.3.2.2. The test may be carried out on a level road, the trailer being towed by a motor vehicle; during the test, the force applied to the control shall be adjusted so as to keep the resistance of the trailer constant (7 % of the maximum stationary axle load of the trailer). If the power available for hauling is insufficient, the test can be conducted at a lower speed but over a greater distance; as shown in the following table:

▼ M7

Speed (km/h)	Distance (metres)
40	1 700
30	1 950
20	2 500
15	3 100

## 1.3.3. Hot performance

1.3.3.1. At the end of the Type I test (test described in point 1.3.1 or test described in point 1.3.2 of this Annex) the hot performance of the service braking system shall be measured under the same conditions (and in particular at a constant control force no greater than the mean force actually used) as for the Type 0 test with the engine disconnected (the temperature conditions may be different). For motor vehicles, this hot performance shall not be less than 80 % of that prescribed for the category in question nor less than 60 % of the figure recorded in the Type 0 test with the engine disconnected. However in the case of trailers, the hot brake force at the periphery of the wheels when tested at 40 km/h shall not be less than 36 % of the maximum stationary wheel load, or less than 60 % of the figure recorded in the Type 0 test at the same speed.

1.3.3.2. In the case of a motor vehicle which satisfies the 60 % requirement specified in point 1.3.3.1, but which cannot comply with the 80 % requirement specified in point 1.3.3.1, a further hot performance test may be carried out using a control force not exceeding that specified in point 2.1.1.1 of this Annex. The results of both tests are entered in the report.

1.4. *Type II test* (downhill behaviour test)

1.4.1. Laden motor vehicles shall be tested in such a manner that the energy input is equivalent to that recorded in the same period of time with a laden vehicle driven at an average speed of 30 km/h on a 6 % down gradient for a distance of 6 km, with the appropriate gear engaged and the retarder, if the vehicle is fitted with one, being used. The gear engaged shall be such that the speed of the engine does not exceed the maximum value prescribed by the manufacturer.

1.4.2. For vehicles in which the energy is absorbed by the braking action of the engine alone, a tolerance of  $\pm 5$  km/h on the average speed shall be permitted, and the gear enabling the speed to be stabilised at the value closest to 30 km/h on the 6 % down gradient shall be engaged. If the performance of the braking action of the engine alone is determined by a measurement of deceleration, it shall be sufficient if the mean deceleration measured is at least  $0,5 \text{ m/s}^2$ .

1.4.3. At the end of the test, the hot performance of the service braking system shall be measured in the same conditions as for the Type 0 test with the engine disconnected (the temperature conditions, of course, may be different). This hot performance shall give a stopping distance not exceeding the following values and a mean fully developed deceleration not less than the following values, using a control force not exceeding 700 N:

category M<sub>3</sub>:

$$s = 0,15 v + \frac{1,33 v^2}{130}$$

(the second term corresponding to a mean fully developed deceleration of  $3,75 \text{ m/s}^2$ );



▼ M7

category N<sub>3</sub>:

$$s = 0,15 v + \frac{1,33 v^2}{115}$$

(the second term corresponding to a mean fully developed deceleration of 3,3 m/s<sup>2</sup>).

1.5. *Type IIA test*

1.5.1. Laden vehicles shall be tested in such a manner that the energy input is equivalent to that recorded in the same period of time with a laden vehicle driven at an average speed of 30 km/h on a 7 % down gradient for a distance of 6 km. During the test, the service, secondary and parking braking systems shall not be engaged. The gear engaged shall be such that the speed of the engine does not exceed the maximum value prescribed by the manufacturer. An integrated retarder may be used, provided that it is suitably phased such that the service braking system is not applied; this may be verified by checking that these brakes remain cold, as defined in point 1.2.1.1 of this Annex.

1.5.2. For vehicles in which the energy is absorbed by the braking action of the engine alone, a tolerance of ± 5 km/h on the average speed shall be permitted and the gear enabling the speed to be stabilised at the value closest to 30 km/h on a 7 % down gradient shall be engaged. If the performance of the braking action of the engine alone is determined by a measurement of deceleration, it shall be sufficient if the mean deceleration measured is at least 0,6m/s<sup>2</sup>.

1.6. *Type III test (Fade test for vehicles of category O<sub>4</sub>)*

1.6.1. Track test

For the road test the conditions should be as follows:

Number of brake applications: 20  
 Duration of braking cycle: 60 s  
 Initial speed at the beginning of braking: 60 km/h  
 Braking applications: corresponding to a trailer deceleration of 3 m/s<sup>2</sup>

The braking rate of a trailer shall be calculated according to point 1.2.4.3 of this Annex:

$$z_R = (z_{R+M} - R) \times \frac{(P_M + P_R)}{P_R} + R$$

The speed at the end of braking (Annex VII, appendix 1, point 3.1.5):

$$v_2 = v_1 \sqrt{\frac{P_M + P_1 + \left(\frac{P_2}{4}\right)}{P_M + P_1 + P_2}}$$

where:

$Z_R$  = braking rate of the trailer  
 $Z_{R+M}$  = braking rate of the vehicle combination (motor vehicle and trailer)  
 $R$  = rolling resistance value = 0,01  
 $P_M$  = total normal static reaction between the road surface and the wheels of trailer (kg)  
 $P_R$  = total normal static reaction between the road surface and the wheels of towing vehicle for trailer (kg)  
 $P_1$  = part of the mass of the trailer borne by the unbraked axle(s) (kg)  
 $P_2$  = part of the mass of the trailer borne by the braked axle(s) (kg)

▼ **M7**

$v_1$  = initial speed (km/h)

$v_2$  = final speed (km/h)

## 1.6.2. Hot performance

At the end of the test according to point 1.6.1, the hot performance of the service braking system shall be measured under the same conditions as for the Type 0 test with, however, different temperature conditions and starting from an initial speed of 60 km/h. The hot brake-force at the periphery of the wheels shall not be less than 40 % of the maximum stationary wheel load, and not less than 60 % of the figure recorded in the Type 0 test at the same speed.

## 2. PERFORMANCE OF BRAKING SYSTEMS

## 2.1. Vehicles of categories M and N

## 2.1.1. Service braking systems

## 2.1.1.1. Provisions relating to tests

2.1.1.1.1. The service braking systems of vehicles of categories M and N shall be tested under the conditions shown in the following table:

Type of test		M <sub>1</sub> 0-I	M <sub>2</sub> 0-I	M <sub>3</sub> 0-I-II/IIA	N <sub>1</sub> 0-I	N <sub>2</sub> 0-I	N <sub>3</sub> 0-I-II/IIA
Type 0 test with engine connected	prescribed speed	80 km/h	60 km/h	60 km/h	80 km/h	60 km/h	60 km/h
	$s \leq$	$0,1 v + \frac{v^2}{150}$			$0,15 v + \frac{v^2}{130}$		
	$d_m \geq$	5,8 ms <sup>-2</sup>			5 ms <sup>-2</sup>		
Type 0 test with engine disconnected	$v = 80\%$ $v_{max}$ but $\leq$ :	160 km/h	100 km/h	90 km/h	120 km/h	100 km/h	90 km/h
	$s \leq$	$0,1 v + \frac{v^2}{130}$			$0,15 v + \frac{v^2}{103,5}$		
	$d_m \geq$	5 ms <sup>-2</sup>			4 ms <sup>-2</sup>		
	$F \leq$	500 N			700 N		

where:

$v$  = test speed in km/h

$s$  = stopping distance in m

$d_m$  = mean fully developed deceleration at normal engine speed

$F$  = force applied to foot control

$v_{max}$  = maximum speed of the vehicle.

2.1.1.1.2. In the case of a motor vehicle authorised to tow an unbraked trailer, the minimum performance prescribed for the corresponding motor vehicle category (for the Type 0 test with engine disconnected) shall be attained with the unbraked trailer coupled to the motor vehicle and with the unbraked trailer laden to the maximum mass declared by the motor vehicle manufacturer. However, in the case of category M<sub>1</sub> vehicles, the minimum combination performance shall be not less than 5,4 m/s<sup>2</sup> both in laden and unladen conditions.

▼ M7

The combination performance shall be verified by calculations referring to the maximum braking performance actually achieved by the motor vehicle alone, laden, (and unladen in the case of M<sub>1</sub>) during the Type 0 test with engine disconnected, using the following formula (no practical tests with a coupled unbraked trailer are required):

$$d_{M+R} = d_M \tilde{n} \frac{PM}{PM + PR}$$

where

$d_{M+R}$  = calculated mean fully developed deceleration of the motor vehicle when coupled to an unbraked trailer in m/s<sup>2</sup>

$d_M$  = maximum mean fully developed deceleration of the motor vehicle alone achieved during the Type 0 test with engine disconnected in m/s<sup>2</sup>

PM = mass of the motor vehicle, laden (and unladen in the case of M<sub>1</sub>)

PR = maximum mass of an unbraked trailer which may be coupled, as declared by the motor vehicle manufacturer.

## 2.1.2. Secondary braking systems

2.1.2.1. The secondary braking system, even if the control which actuates it is also used for other braking functions, shall give a stopping distance not exceeding the following values and a mean fully developed deceleration not less than the following values:

category M<sub>1</sub>:

$$s = 0,1 v + \frac{2 v^2}{150}$$

(the second term corresponding to a mean fully developed deceleration of 2,9 m/s<sup>2</sup>)

category M<sub>2</sub>, M<sub>3</sub>:

$$s = 0,15 v + \frac{2 v^2}{130}$$

(the second term corresponding to a mean fully developed deceleration of 2,5 m/s<sup>2</sup>)

category N:

$$s = 0,15 v + \frac{2 v^2}{115}$$

(the second term corresponding to a mean fully developed deceleration of 2,2 m/s<sup>2</sup>).

2.1.2.2. If the secondary braking system control is a manual control, the prescribed performance shall be obtained by applying to the control a force not exceeding 400 N in the case of category M<sub>1</sub> vehicles and 600 N in the case of other vehicles, and the control shall be so placed that it can be easily and quickly grasped by the driver.

2.1.2.3. If the secondary braking systems control is a foot control, the prescribed performance shall be obtained by applying to the control a force not exceeding 500 N in the case of category M<sub>1</sub> vehicles and 700 N in the case of other vehicles, and the control shall be so placed that it can be easily and quickly actuated by the driver.

2.1.2.4. The performance of the secondary braking system shall be checked by the Type 0 test with the engine disconnected from the following initial speeds:

M<sub>1</sub> = 80 km/h      M<sub>2</sub> = 60 km/h      M<sub>3</sub> = 60 km/h

## ▼M7

$N_1 = 70$  km/h       $N_2 = 50$  km/h       $N_3 = 40$  km/h

- 2.1.2.5. The secondary braking effectiveness test shall be conducted by simulating the actual failure conditions in the service braking system.
- 2.1.3. Parking braking systems
- 2.1.3.1. The parking braking system shall, even if it is combined with one of the other braking systems, be capable of holding a laden vehicle stationary on an 18 % up or down gradient.
- 2.1.3.2. On vehicles to which the coupling of a trailer is authorised, the parking braking system of the towing vehicle shall be capable of holding the combination of vehicles stationary on a 12 % gradient.
- 2.1.3.3. If the control is a manual control, the force applied to it shall not exceed 400 N in the case of category  $M_1$  vehicles and 600 N in the case of all other vehicles.
- 2.1.3.4. If it is a foot control, the force exerted on the control shall not exceed 500 N in the case of category  $M_1$  vehicles and 700 N in the case of all other vehicles.
- 2.1.3.5. A parking braking system which has to be actuated several times before attaining the prescribed performance shall be admissible.
- 2.1.3.6. To check compliance with the requirements of Annex I, point 2.2.1.2.4, a Type 0 test shall be carried out with the engine disconnected at the initial speed of 30 km/h. The mean fully developed deceleration on application of the control of the parking brake system and the deceleration immediately before the vehicle stops shall not be less than 1,5 m/s<sup>2</sup>. The test shall be carried out with the laden vehicle. The force exerted on the braking control device shall not exceed the specified values.
- 2.1.4. Residual service braking performance after transmission failure
- 2.1.4.1. The residual performance of the service braking system, in the event of failure in a part of its transmission, shall give a stopping distance not exceeding the following values and a mean fully developed deceleration not less than the following values, using a control force not exceeding 700 N, when checked by the Type 0 test with the engine disconnected from the following initial speeds for the relevant vehicle category:

Stopping distance (m) and mean fully developed deceleration (m/s<sup>2</sup>)

Type	km/h	Laden	m/s <sup>2</sup>	Unladen	m/s <sup>2</sup>
$M_1$	80	$0,1v + \frac{100}{30} \times \frac{v^2}{150}$	1,7	$0,1v + \frac{100}{25} \times \frac{v^2}{150}$	1,5
$M_2$	60	$0,15v + \frac{100}{30} \times \frac{v^2}{130}$	1,5	$0,15v + \frac{100}{25} \times \frac{v^2}{130}$	1,3
$M_3$	60	$0,15v + \frac{100}{30} \times \frac{v^2}{130}$	1,5	$0,15v + \frac{100}{30} \times \frac{v^2}{130}$	1,5
$N_1$	70	$0,15v + \frac{100}{30} \times \frac{v^2}{115}$	1,3	$0,15v + \frac{100}{25} \times \frac{v^2}{115}$	1,1
$N_2$	50	$0,15v + \frac{100}{30} \times \frac{v^2}{115}$	1,3	$0,15v + \frac{100}{25} \times \frac{v^2}{115}$	1,1
$N_3$	40	$0,15v + \frac{100}{30} \times \frac{v^2}{115}$	1,3	$0,15v + \frac{100}{30} \times \frac{v^2}{115}$	1,3

▼ **M7**

2.1.4.2. The residual braking effectiveness test shall be conducted by simulating the actual failure conditions in the service braking systems.

2.2. *Vehicles of category O*

2.2.1. Service braking systems

2.2.1.1. Requirement relating to tests of category O<sub>1</sub> vehicles

2.2.1.1.1. Where the provision of a service braking system is mandatory, the performance of the system shall meet the requirements laid down for category O<sub>2</sub> vehicles.

2.2.1.2. Requirements relating to tests of category O<sub>2</sub> vehicles.

2.2.1.2.1. If the service braking system is of the continuous or semi-continuous type, the sum of the forces exerted at the periphery of the braked wheels shall be at least X % of the maximum stationary wheel load, X having the following values:

Full trailer, laden and unladen	50
Semi-trailer, laden and unladen	45
Centre-axle trailer, laden and unladen	50.

Where the trailer is fitted with a compressed-air braking system, the pressure in the control line shall not exceed 6,5 bar <sup>(1)</sup> and the pressure in the supply line shall not exceed 7,0 bar <sup>(1)</sup> during the brake test. The test speed is 60 km/h.

A supplementary test at 40 km/h must be carried out with the laden vehicle for comparison with the Type I test result.

2.2.1.2.2. Where the braking system is of the inertia type, it shall comply with the conditions laid down in Annex VIII.

2.2.1.2.3. In addition, these vehicles shall be subjected to the Type I test.

2.2.1.2.4. In the Type I test of a semi-trailer, the mass braked by its axle(s) shall correspond to the maximum axle load(s) (not including the king pin load).

2.2.1.3. Requirements relating to the testing of category O<sub>3</sub> vehicles.

2.2.1.3.1. The same requirements apply as to category O<sub>2</sub> vehicles.

2.2.1.4. Requirements relating to tests of category O<sub>4</sub> vehicles.

2.2.1.4.1. If the service braking system is of the continuous or semi-continuous type, the sum of the forces exerted at the periphery of the braked wheels shall be equal to at least X % of the maximum stationary wheel load, X having the following values:

full trailer, laden and unladen	50
semi-trailer, laden and unladen	45
centre-axle trailer, laden and unladen	50.

Where the trailer is fitted with a compressed air braking system, the pressure in the control line shall not exceed 6,5 bar <sup>(1)</sup> and the pressure in the supply line shall not exceed 7,0 bar <sup>(1)</sup> during the brake test. The test speed is 60 km/h.

2.2.1.4.2. In addition, the vehicles shall undergo the Type-III test.

2.2.1.4.3. In the Type-III test of a semi-trailer, the mass braked by the latter's axle(s) shall correspond to the maximum axle load(s).

2.2.2. Parking braking systems

2.2.2.1. The parking braking system with which the trailer or semi-trailer is fitted shall be capable of holding the laden trailer or semi-trailer

<sup>(1)</sup> The pressures specified here and in the following Annexes are relative pressures measured in bars.

**▼M7**

stationary, when separated from the towing vehicle, on an 18 % up or down gradient. The force applied to the control shall not exceed 600 N.

2.2.3. Automatic braking systems

2.2.3.1. The automatic braking performance in the event of a total pressure loss in the air supply line, when testing the laden vehicle from 40 km/h, shall not be less than 13,5 % of the maximum stationary wheel load. Wheel-locking at performance levels above 13,5 % is permitted.

2.3. *Reaction time*

Where a vehicle is fitted with a service braking system which is totally or partially dependent on a source of energy other than the muscular effort of the driver, the following requirements shall be satisfied:

2.3.1. In an emergency manoeuvre, the time elapsing between the moment when the control begins to be actuated and the moment when the braking force on the least favourably placed axle reaches the level corresponding to the prescribed performance shall not exceed 0,6 seconds.

2.3.2. In the case of vehicles fitted with compressed-air braking systems, the requirements of point 2.3.1 are considered to be satisfied if the vehicle complies with the provisions of Annex III.

2.3.3. In the case of vehicles fitted with hydraulic braking systems, the requirements of point 2.3.1 are considered to be satisfied if, in an emergency manoeuvre, the deceleration of the vehicle, or the pressure at the least favourable brake cylinder, reaches a level corresponding to the prescribed performance within 0,6 seconds.

▼ **M7***Appendix*

(See point 1.1.4.2)

**Distribution of braking effort among vehicle axles**

## 1. GENERAL REQUIREMENTS

Vehicles of categories M, N, O<sub>3</sub> and O<sub>4</sub> which are not equipped with an anti-lock system as defined in Annex X shall meet all the requirements of this Appendix. If a special device is used, this shall operate automatically. However, vehicles — other than those of category M<sub>1</sub> — which are equipped with an anti-lock system as defined in Annex X, shall also meet the requirements of points 7 and 8 of this Appendix if they are in addition fitted with a special automatic device which controls the distribution of braking among the axles. In the event of failure of its control, it shall be possible to stop the vehicle as stipulated under points 6 of this Appendix.

## 2. SYMBOLS

$i$	=	axle index ( $i = 1$ , front axle; $i = 2$ , second axle; etc.)
$P_i$	=	normal reaction of road surface on axle $i$ under static conditions
$N_i$	=	normal reaction of road surface on axle $i$ under braking
$T_i$	=	force exerted by the brakes on axle $i$ under normal braking conditions on the road
$f_i$	=	$T_i/N_i$ -adhesion used by axle $i$ <sup>(1)</sup>
$J$	=	deceleration of vehicle
$g$	=	acceleration due to gravity $g = 10 \text{ m/s}^2$
$z$	=	braking rate of vehicle = $J/g$ <sup>(2)</sup>
$P$	=	mass of vehicle
$h$	=	height above ground of centre of gravity specified by the manufacturer and agreed by the technical services conducting the approval test
$E$	=	wheelbase
$k$	=	theoretical coefficient of adhesion between tyre and road
$K_c$	=	correction factor — semi-trailer laden
$K_v$	=	correction factor — semi-trailer unladen
$TM$	=	sum of braking forces at the periphery of wheels of towing vehicles for trailers or semi-trailers
$PM$	=	total normal static reaction between road surface and wheels of towing vehicles for trailers or semi-trailers as referred to in points 3.1.4 and 3.1.5 respectively
$P_m$	=	pressure at coupling head of control line
$TR$	=	sum of braking forces at periphery of all wheels of trailer or semi-trailer
$PR$	=	total normal static reaction of road surface on wheels of trailer or semi-trailer
$PR_{\max}$	=	value of $PR$ at maximum mass of semi-trailer
$E_R$	=	distance between king-pin and centre of axle or axles of semi-trailer

<sup>(1)</sup> Adhesion curves used by each axle means curves showing the adhesion used by axle  $i$  plotted against the vehicle braking rate under specified load conditions.

<sup>(2)</sup> For semi-trailers,  $z$  is the braking force divided by the static mass on the semi-trailer axle(s).

▼ M7

$h_R$  = height above ground of centre of gravity of semi-trailer specified by the manufacturer and agreed by the technical services conducting the approval test.

## 3. REQUIREMENTS FOR MOTOR VEHICLES

3.1. *Two-axle vehicles*

3.1.1. (1) For all categories of vehicles for  $k$  values between 0,2 and 0,8:

$$z \geq 0,1 + 0,85 (k - 0,2)$$

For all states of load of the vehicle, the adhesion curve of the front axle shall be situated above that of the rear axle:

— for all braking rates of between 0,15 and 0,8 in the case of vehicles of category  $M_1$ .

However, for vehicles of this category over the range of  $z$  values between 0,3 and 0,45, an inversion of the adhesion utilisation curves is permitted provided that the adhesion utilisation curve of the rear axle does not exceed by more than 0,05 the line defined by the formula  $k = z$  (line of ideal adhesion utilisation — see diagram 1A),

— for all braking rates of between 0,15 and 0,5 in the case of vehicles of category  $N_1$  (2).

This condition is also considered satisfied if, for braking rates between 0,15 and 0,30, the adhesion utilisation curves for each axle are situated between two parallels to the line of ideal adhesion utilisation given by the equations  $k = z + 0,08$  and  $k = z - 0,08$  as shown in diagram 1C, where the adhesion utilisation curve for the rear axle may cross the line  $k = z - 0,08$  and, for braking rates between 0,3 and 0,5, complies with the relation  $z \geq k - 0,08$  and between 0,5 and 0,61 with the relation  $z \geq 0,5 k + 0,21$ ,

— for all braking rates of between 0,15 and 0,30 in the case of other categories. This condition is also considered satisfied if, for braking rates between 0,15 and 0,30 the adhesion utilisation curves for each axle are situated between two parallels to the line of ideal adhesion utilisation given by the equations  $k = z + 0,08$  and  $k = z - 0,08$  as shown in diagram 1B, and the adhesion utilisation curve for the rear axle, for braking rates  $z \geq 0,3$  complies with the relation:

$$z \geq 0,3 + 0,74 (k - 0,38)$$

3.1.2. In the case of a motor vehicle authorised to tow trailers of category  $O_3$  or  $O_4$  fitted with compressed-air braking systems:

3.1.2.1. When tested with the energy source stopped, the supply line blocked off and a reservoir of 0,5 litre capacity connected to the control line, and the system at cut-in and cut-out pressures, the pressure at full application of the service braking system control shall be between 6,5 and 8,5 bar at the coupling heads of the supply line and the control line, irrespective of the load condition of the vehicle. These pressures shall be demonstrably present in the towing vehicle when uncoupled from the trailer. The compatibility bands in diagrams 2, 3 and 4A of this Appendix to Annex II shall not be extended beyond 7,5 bar.

3.1.2.2. It shall be ensured that at the coupling head of the supply line a pressure of at least 7 bar is available when the system is at cut-in pressure; this pressure shall be demonstrated without applying the service braking system.

(1) The provisions of point 3.1.1 do not affect the requirements of Annex II relating to the braking efficiency. However, if, when verifying the provisions of point 3.1.1 braking efficiencies are obtained which are higher than those prescribed in Annex II, the provisions relating to the adhesion utilisation curve shall be applied within the areas of diagrams IA and IB defined by the straight lines  $k = 0,8$  and  $z = 0,8$ .

(2) Vehicles of category  $N_1$  with a laden/unladen rear axle loading ratio not exceeding 1,5 or having a maximum mass of less than 2 tonnes will have to comply with the requirements for category  $M_1$  vehicles of this point from 1 October 1990.



## ▼M7

## 3.1.3. Verification of the requirements of point 3.1.1

In order to verify the requirement of point 3.1.1, the manufacturer shall provide the adhesion utilisation curves for the front and rear axles calculated by the formulae:

$$f_1 = \frac{T_1}{N_1} = \frac{T_1}{P_1 + z \frac{h}{E} P \times g}; \quad f_2 = \frac{T_2}{N_2} = \frac{T_2}{P_2 - z \frac{h}{E} P \times g}.$$

The graphs shall be plotted for both the following load conditions:

— Unladen, in running order with the driver on board.

In the case of a vehicle presented as a bare chassis-cab, a supplementary load may be added to simulate the mass of the body, not exceeding the minimum mass declared by the manufacturer in Annex XVIII.

— Laden.

Where provision is made for several possibilities of load distribution, the one whereby the front axle is the most heavily laden shall be the one to be taken into consideration.

## 3.1.4. Towing vehicles other than tractive units for semi-trailers

3.1.4.1. In the case of a motor vehicle authorised to tow trailers of category O<sub>3</sub> or O<sub>4</sub> fitted with compressed-air braking systems, the permissible relationship between the braking rate

$$\frac{TM}{PM}$$

and the pressure  $p_m$  shall be within the areas shown in diagram 2.

## 3.1.5. Tractive units for semi-trailers

## 3.1.5.1. Tractive units with unladen semi-trailer

An unladen articulated combination is considered to be a tractive unit in running order, with the driver on board, coupled to an unladen semi-trailer. The dynamic load of the semi-trailer on the tractive unit shall be represented by a static mass, mounted at the location of the king pin of the fifth wheel coupling, equal to 15 % of the maximum mass on the coupling. The braking forces shall continue to be regulated between the state of the tractive unit with semi-trailer (unladen) and that of the tractive unit alone, (without semi-trailer); the braking forces relating to the tractive unit alone shall be verified.

## 3.1.5.2. Tractive units with laden semi-trailer

A laden articulated combination shall be considered to be a tractive unit in running order with the driver on board coupled to a laden semi-trailer. The dynamic load of the semi-trailer on the tractive unit shall be represented by a static mass  $P_s$ , mounted at the location of the king pin of the fifth wheel coupling, equal to:

$$P_s = P_{so} (1 + 0,45 z)$$

where  $P_{so}$  represents the difference between the maximum laden mass of the tractive unit and its unladen mass.

For  $h$  the following value shall be taken:

$$h = \frac{h_0 P_o + h_s P_s}{P}$$

where:

$h_0$  is the height of the centre of gravity of the tractive unit

$h_s$  is the height of the coupling on which the semi-trailer rests

$P_o$  is the unladen mass of the solo tractive unit

▼ M7

$$P = P_0 + P_s = P_1 + P_2$$

- 3.1.5.3. In the case of a vehicle fitted with a compressed-air braking system, the permissible relationship between the braking rate

$$\frac{TM}{PM}$$

and the pressure  $p_m$  shall be within the areas shown in diagram 3.

- 3.2. *Vehicles with more than two axles*

The requirements of point 3.1 shall apply to vehicles with more than two axles. The requirements of point 3.1.1 with respect to wheel-lock sequence shall be considered to be met, if in the case of braking rates of between 0,15 and 0,30, the adhesion used by at least one of the front axles shall be greater than that used by at least one of the rear axles.

4. REQUIREMENTS FOR SEMI-TRAILERS

- 4.1. For semi-trailers fitted with compressed-air braking systems

The permissible relationship between the braking rate

$$\frac{TR}{PR}$$

and the pressure  $p_m$  shall lie within two areas derived from diagrams 4A and 4B for the laden and unladen states of load. This requirement shall be met for all permissible load conditions of the semi-trailer axles.

- 4.2. If the requirements of point 4.1 cannot be satisfied in conjunction with the requirements of point 2.2.1.2.1 of Annex II for semi-trailers with a  $K_c$  factor less than 0,8 then the semi-trailer shall meet the minimum braking performance specified in point 2.2.1.2.1 of Annex II and be fitted with an anti-lock system complying with Annex X, except the compatibility requirement in point 1 of that Annex.

5. REQUIREMENTS FOR FULL AND CENTRE-AXLE TRAILERS

- 5.1. For full trailers fitted with compressed-air braking systems:

- 5.1.1. The requirements set out in point 3.1 shall apply to twin axle trailers (except where the axle spread is less than two metres).

- 5.1.2. Full trailers with more than two axles shall be subject to the requirements contained in point 3.2.

- 5.1.3. The permissible relationship between the braking rate

$$\frac{TR}{PR}$$

and the pressure  $p_m$  shall lie within the designated areas in diagram 2 for the laden and unladen states of load.

- 5.2. For centre-axle trailers fitted with compressed-air braking systems:

- 5.2.1. the permissible relationship between the braking rate

$$\frac{TR}{PR}$$

and the pressure  $p_m$  shall lie within two areas derived from diagram 2, by multiplying the vertical scale by 0,95, for the laden and unladen states of load.

- 5.2.2. If the requirements of point 2.2.1.2.1 of Annex II cannot be satisfied due to lack of adhesion, then the centre-axle trailer shall be fitted with an anti-lock system complying with Annex X.

▼ **M7****6. CONDITIONS TO BE FULFILLED IN THE CASE OF FAILURE OF THE BRAKING DISTRIBUTION SYSTEM**

When the requirements of this Appendix are fulfilled by means of a special device (e. g. controlled mechanically by the suspension of the vehicle), it shall be possible, in the event of the failure of this device or its means of control, to stop the vehicle under the conditions specified for secondary braking in the case of motor vehicles; for those vehicles authorised to tow a trailer fitted with air brakes, it shall be possible to achieve a pressure at the coupling head of the control line within the range specified in point 3.1.2 of this Appendix. In the event of failure of the means of controlling the device in trailers and semi-trailers, a braking rate of at least 30 % of the service braking system performance prescribed for the vehicle in question shall be attained.

**7. MARKINGS**

7.1. Vehicles, other than those of category M<sub>1</sub>, which meet the requirements of this Appendix by means of a device mechanically controlled by the suspension of the vehicle, shall be marked to show the useful travel of the device between the positions corresponding to vehicle unladen and laden states respectively and any further information to enable the setting of the device to be checked.

7.1.1. When a load sensing device is controlled via the suspension of the vehicle by any other means, the vehicle shall be marked with information to enable the setting of the device to be checked.

7.2. When the requirements of this Appendix are met by means of a device which modulates the air pressure in the brake transmission, the vehicle shall be marked to show the axle loads at the ground, the nominal outlet pressures of the device and an inlet pressure of not less than 80 % of the maximum design inlet pressure, as declared by the vehicle manufacturer, for the following states of load:

7.2.1. Technically permissible maximum axle load for the axle(s) which control(s) the device.

7.2.2. Axle load(s) corresponding to the mass of the vehicle in running order as defined in point 2.6 of Annex I to Directive 70/156/EEC.

7.2.3. The axle load(s) approximating to the vehicle with proposed bodywork in running order where the axle load(s) mentioned in point 7.2.2 relate(s) to the vehicle chassis with cab.

7.2.4. The axle load(s) designated by the manufacturer to enable the setting of the device to be checked in service if this is (these are) different from the loads specified in points 7.2.1, 7.2.2 and 7.2.3.

7.3. Point 1.7.2 of the addendum to the type-approval certificate (Appendix 1 of Annex IX) shall include information to enable compliance with the requirements of points 7.1 and 7.2 to be checked.

7.4. The markings referred to under points 7.1 and 7.2 shall be affixed in a visible position in indelible form. An example of the markings for a mechanically controlled device in a vehicle fitted with compressed-air braking is shown in diagram 5.

**8. PRESSURE TEST CONNECTIONS**

8.1. Braking systems incorporating the devices referred to in point 7.2 shall be fitted with pressure test connections in the pressure line upstream and downstream of the device, at the closest readily accessible positions. The downstream connection shall not be required if the pressure at that point can be checked at the connection required by point 4.1 of Annex III.

8.2. The pressure test connections shall comply with clause 4 of ISO standard 3583-1984.

**9. VEHICLE INSPECTION**

During the EC type-approval testing of a vehicle the technical inspection authority shall verify conformity with the requirements

▼ M7

contained in the present Appendix and carry out any further tests considered necessary to this end. The report on the additional tests shall be appended to the EC type-approval certificate.

▼ M7

Diagram 1A

Vehicles of category M<sub>1</sub> and certain vehicles of category N<sub>1</sub> from 1 October 1990  
(see point 3.1.1)

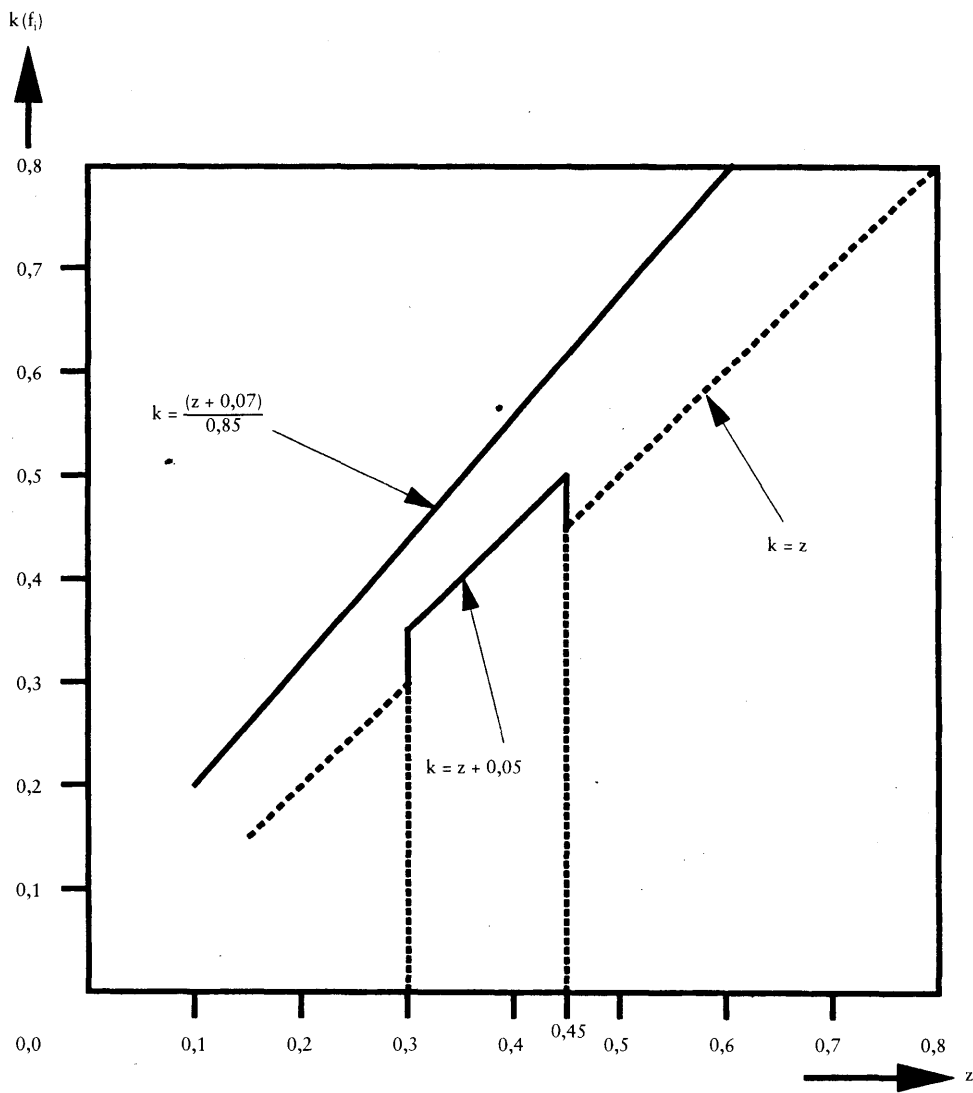

▼ M7

Diagram 1B

Motor vehicles (other than those of categories M<sub>1</sub> and N<sub>1</sub> and full trailers

(see point 3.1.1)

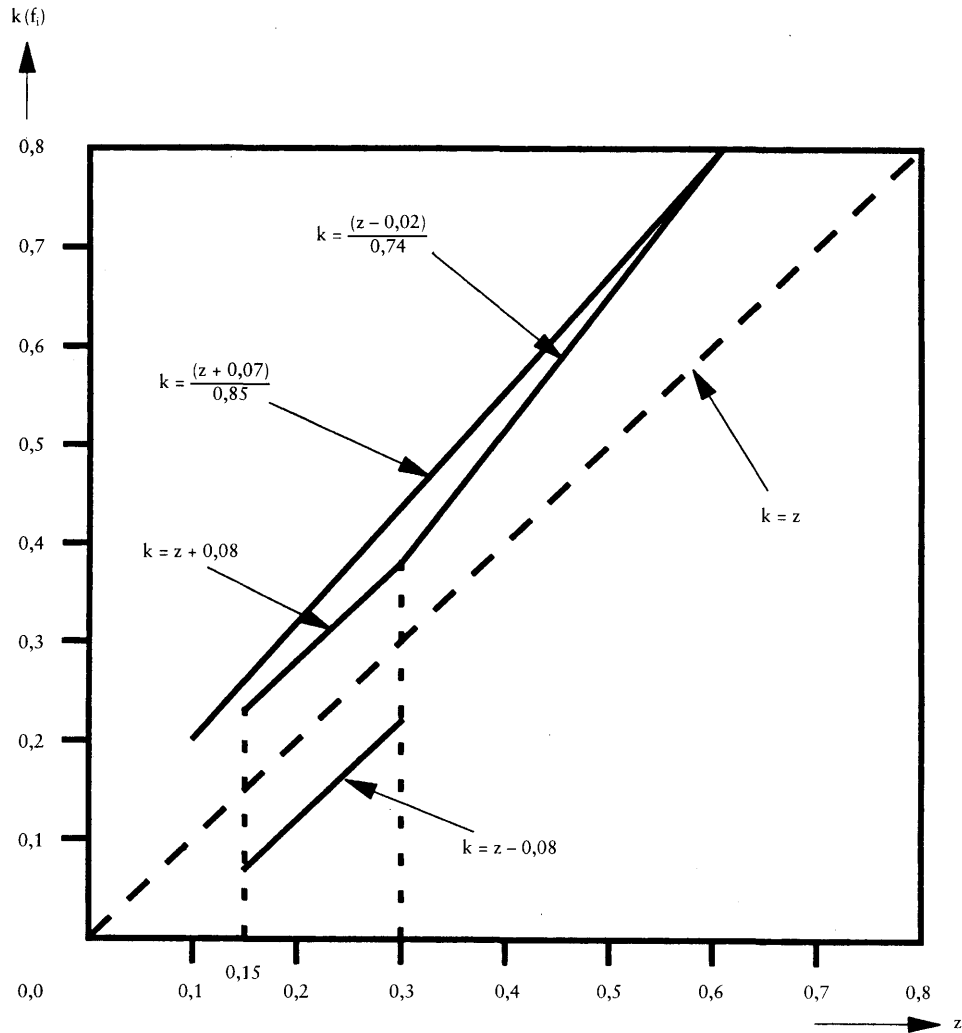

NB: The lower limit of the corridor is not applicable for the adhesion utilisation of the rear axle.

▼ M7

Diagram IC

Vehicles of category N<sub>1</sub> (with certain exceptions from 1 October 1990)

(see point 3.1.1)

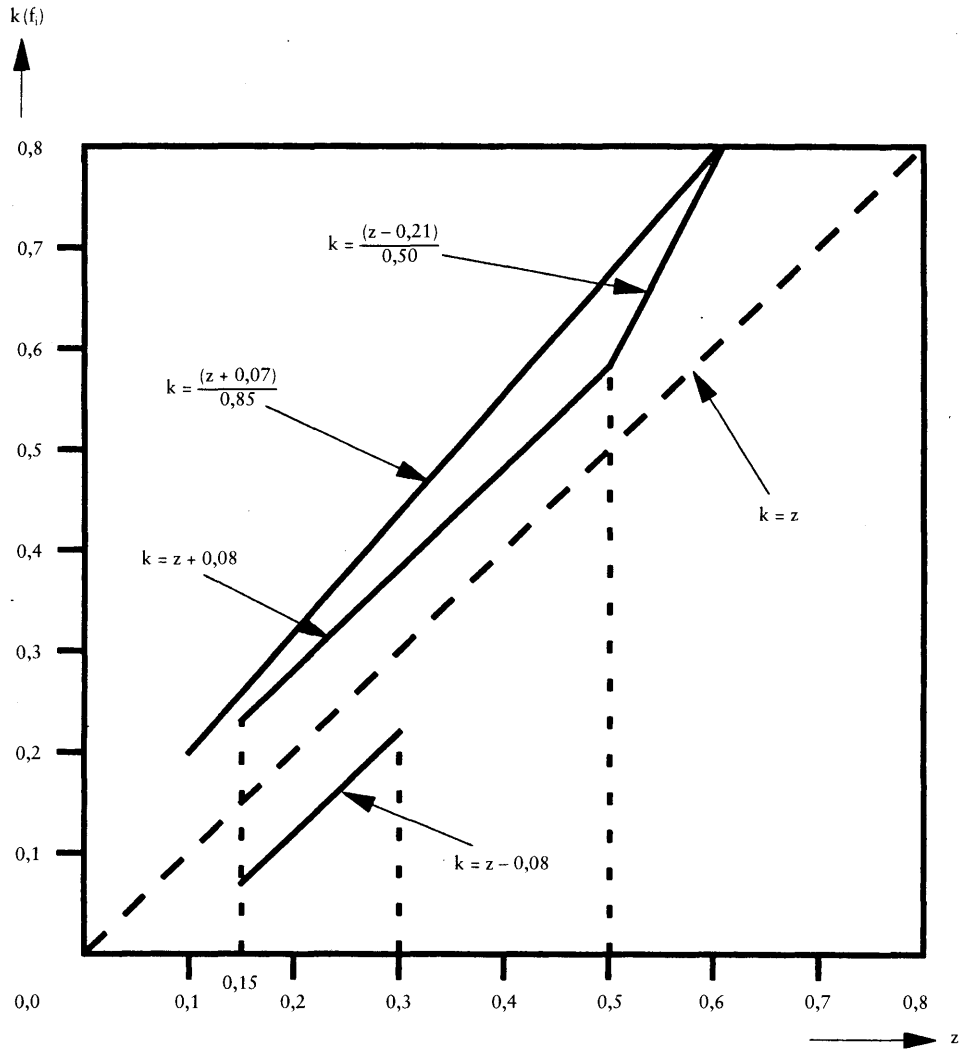

NB: The lower limit of the corridor is not applicable for the adhesion utilisation of the rear axle

▼ M7

*Diagram 2*  
**Towing vehicles and trailers**  
 (see points 3.1.4 and 5)

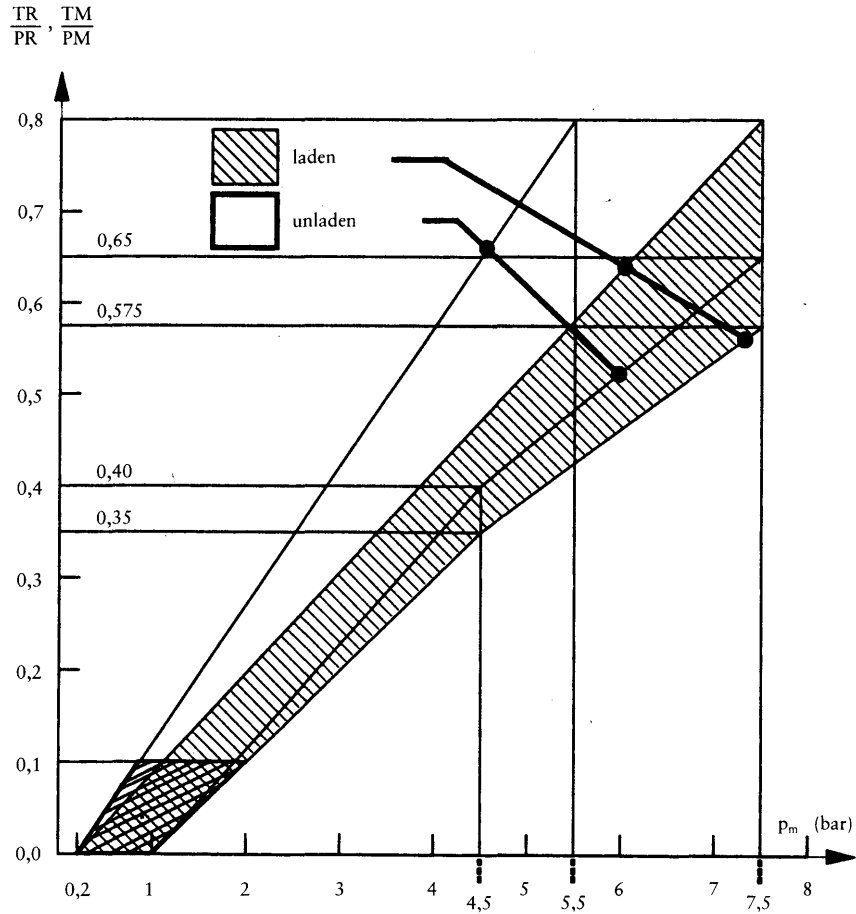

*NB:*

1. It is understood that, between the values

$$\frac{TM}{PM} = 0 \text{ and } \frac{TR}{PR} = 0, 1$$

or

$$\frac{TR}{PR} = 0 \text{ and } \frac{TM}{PM} = 0, 1$$

it is not necessary that there should be proportionality between the braking rate

$$\frac{TM}{PM} \text{ or } \frac{TR}{PR}$$

and the control line pressure as measured at the coupling head.

2. The relationships required by the diagram apply progressively for intermediate states of loading between the laden and the unladen states and shall be achieved by automatic means.



▼ M7

Diagram 3  
 Tractive units for semi-trailers  
 (see point 3.1.5)

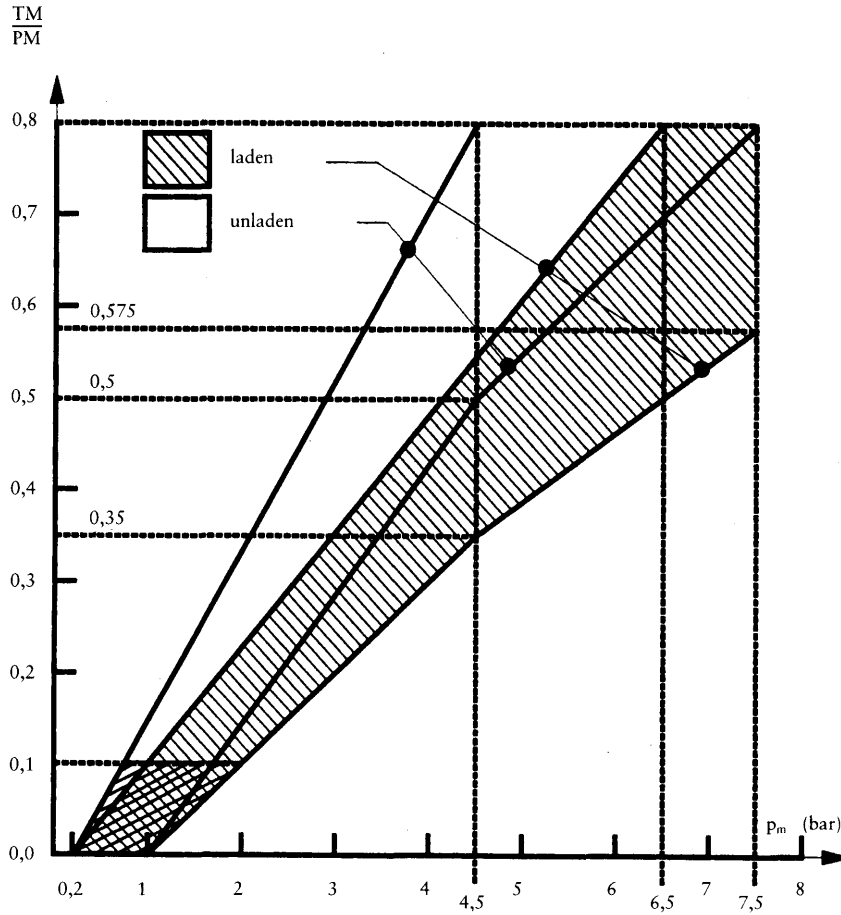

NB:

1. It is understood that, between the values

$$\frac{TM}{PM} = 0 \text{ and } \frac{TM}{PM} = 0,1$$

it is not necessary that there should be proportionality between the braking rate

$$\frac{TM}{PM}$$

and the control line pressure as measured at the coupling head.

2. The relationships required by the diagram apply progressively for intermediate states of loading between the laden and the unladen states and shall be achieved by automatic means.

▼ M7

Diagram 4A

Semi-trailers

(see point 4)

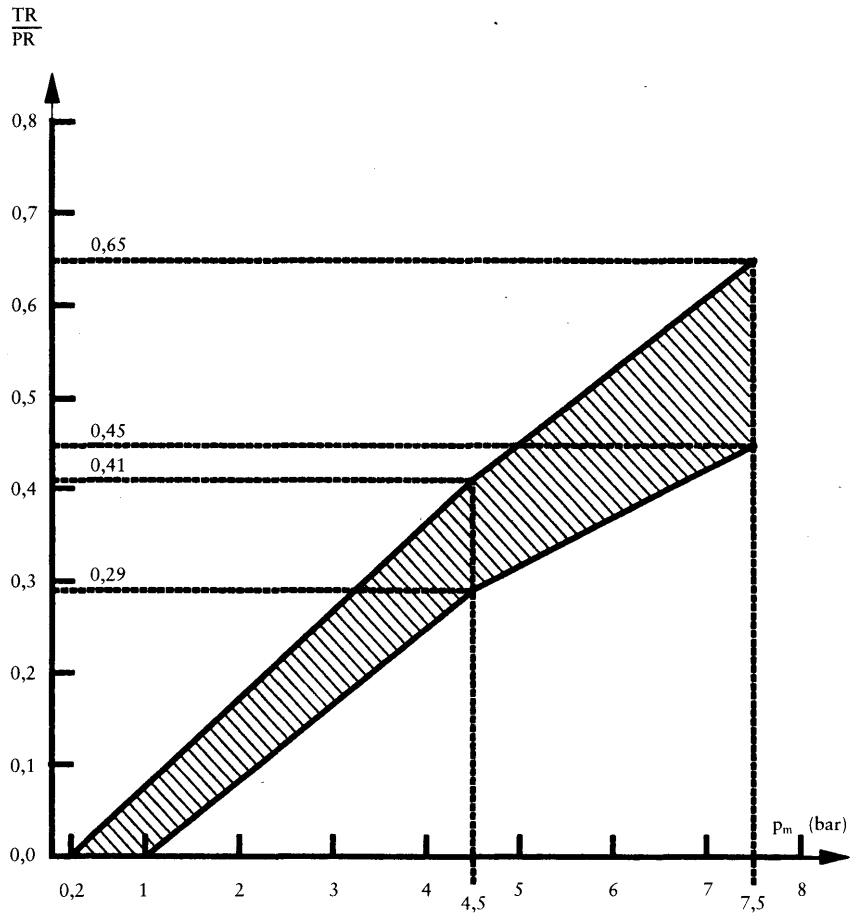

NB:

1. It is understood that, between the values

$$\frac{TR}{PR} = 0 \text{ and } \frac{TR}{PR} = 0,1$$

it is not necessary that there should be proportionality between braking rate

$$\frac{TR}{PR}$$

and the control line pressure as measured at the coupling head.

2. The relationship between the braking rate

$$\frac{TR}{PR}$$

and control line pressure for the laden and unladen condition is determined as follows:

The factors  $K_c$  (laden),  $K_v$  (unladen) are obtained by reference to diagram 4B. Construct the laden and unladen bands by multiplying the upper and lower boundaries of the band in diagram 4A shown above by the two factors obtained,  $K_c$  and  $K_v$  respectively.

▼M7

Diagram 4B  
(see point 4)

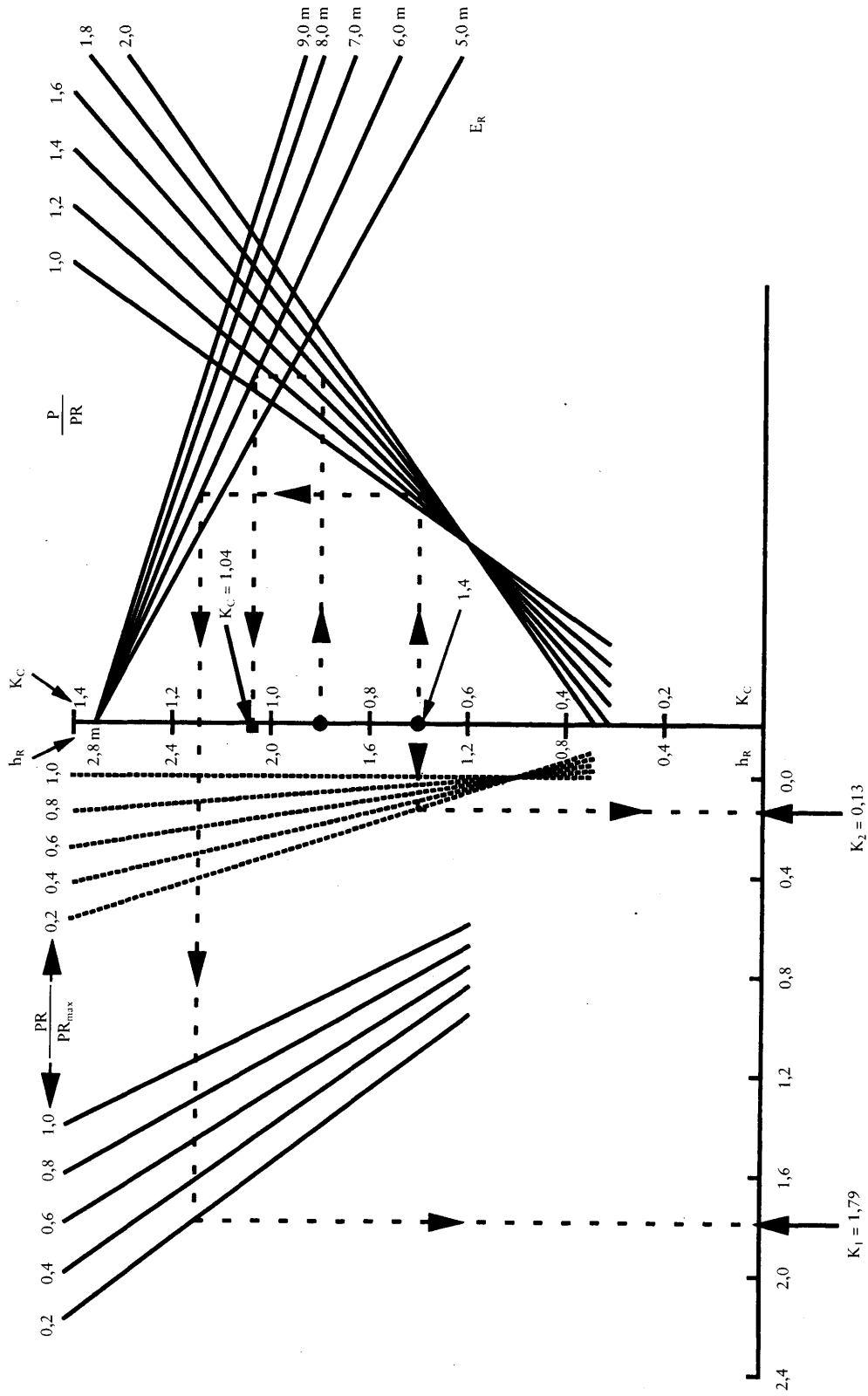

## ▼M7

*Explanatory note on the use of diagram 4B*

1. Formula from which diagram 4B is derived is:

$$K = \left[ 1,7 - \frac{0,7 PR}{PR_{\max}} \right] \left[ 1,35 - \frac{0,96}{E_R} \left( 1,0 + (h_R - 1,2) \frac{g \times P}{PR} \right) \right] - \left[ 1,0 - \frac{PR}{PR_{\max}} \right] \left[ \frac{h_R - 1,0}{2,5} \right]$$

2. Description of the method of use by means of a worked example.

- 2.1 The dashed lines shown on diagram 4B refer to the determination of the factors  $K_c$  and  $K_v$  for the following vehicle where:

	Laden	Unladen
P	24 tonnes	4,2 tonnes
PR	15 tonnes	3 tonnes
PR <sub>max</sub>	15 tonnes	15 tonnes
h <sub>R</sub>	1,8 m	1,4 m
E <sub>R</sub>	6,0 m	6,0 m

In the following items the figures in parenthesis relate only to the vehicle being used for the purpose of illustrating the method of use of Diagram 4B.

- 2.2 Calculate the ratios:

(a)  $\left[ \frac{P}{PR} \right]$  laden (= 1,6)

(b)  $\left[ \frac{P}{PR} \right]$  unladen (= 1,4)

(c)  $\left[ \frac{P}{PR_{\max}} \right]$  unladen (= 0,2)

- 2.3. Determination of the laden factor  $K_c$ :

- (a) Start at appropriate  $h_R$  ( $h_R = 1,8$  m).  
 (b) Move horizontally to the appropriate  $gP/PR$  line ( $gP/PR = 1,6$ ).  
 (c) Move vertically to appropriate  $E_R$  line ( $E_R = 6,0$  m).  
 (d) Move horizontally to  $K_c$  scale,  $K_c$  is the laden factor required ( $K_c = 1,04$ ).

- 2.4. Determination of the unladen factor  $K_v$ :

- 2.4.1. Determination of the factor  $K_2$

- (a) Start at appropriate  $h_R$  ( $h_R = 1,4$  m).  
 (b) Move horizontally to appropriate  $PR/PR_{\max}$  line in group of curves nearest to vertical axis ( $PR/PR_{\max} = 0,2$ ).  
 (c) Move vertically to horizontal axis and read off the value of  $K_2$  ( $K_2 = 0,13$  m).

- 2.4.2. Determination of factor  $K_1$

- (a) Start at appropriate  $h_R$  ( $h_R = 1,4$  m).  
 (b) Move horizontally to the appropriate  $gP/PR$  line ( $gP/PR = 1,4$ ).  
 (c) Move vertically to the appropriate  $E_R$  line ( $E_R = 6,0$  m).  
 (d) Move horizontally to the appropriate  $PR/PR_{\max}$  line in group of curves furthest from the vertical axis ( $PR/PR_{\max} = 0,2$ ).  
 (e) Move vertically to horizontal axis and read off the value of  $K_1$  ( $K_1 = 1,79$ ).

**▼M7**2.4.3. Determination of factor  $K_v$ 

The unladen factor  $K_v$  is obtained from the following expression:

$$K_v = K_1 - K_2 \quad (K_v = 1,66).$$

▼ M7

Diagram 5

## Load sensing device

(see point 7.4)

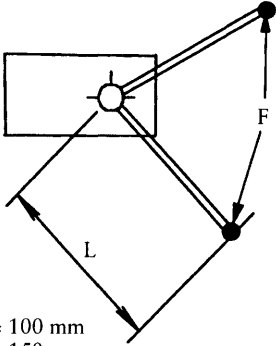
Control data	Vehicle loading	Axle No 2 Load at the ground (daN)	Inlet pressure (bar)	Nominal outlet pressure (bar)
 <p>F = 100 mm L = 150 mm</p>	Laden	10 000	6	6
	Unladen	1 500	6	2,4

▼ **M7***ANNEX III***Method of measuring the reaction time for vehicles with compressed-air braking systems**

1. GENERAL REQUIREMENTS
  - 1.1. The reaction time for the braking system shall be determined with the vehicle stationary, the pressure being measured at the opening of the least favourable brake cylinder. In the case of vehicles fitted with combined compressed-air/hydraulic braking systems, the pressure may be measured at the opening of the least favourable pneumatic unit. For vehicles equipped with load sensing devices, these shall be set in the 'laden' position.
  - 1.2. During the tests, the stroke of the brake cylinders of the individual axles shall be that corresponding to the most closely adjusted brakes.
  - 1.3. The times determined in implementing the provisions of this Annex shall be rounded to the nearest 10th of a second. If the figure representing the 100ths is five or more, the reaction time is rounded up to the next highest 10th.
2. MOTOR VEHICLES
  - 2.1. At the start of each test, the pressure in the reservoirs shall be equal to the minimum pressure at which the governor starts feeding the installation again. In installations not fitted with a governor (e.g. pressure-limited compressor) the pressure in the reservoir at the start of each test shall be equal to 90 % of the pressure stated by the manufacturer, as defined in point 1.2.2.1 of Annex IV, to be used for tests prescribed in this Annex.
  - 2.2. Reaction times in terms of actuation time ( $t_f$ ) shall be obtained by a series of actuations to the fullest extent, starting from the shortest possible up to a time of about 0,4 seconds. The values measured shall be given on a diagram.
  - 2.3. Reaction times corresponding to an actuation time of 0,2 seconds shall be determinant for the test. This reaction time can be obtained from the diagram by interpolation.
  - 2.4. In the case of the actuation time of 0,2 seconds, the time elapsing between the beginning of actuation of the control pedal and the moment when the pressure in the brake cylinder reaches 75 % of its asymptotic value shall not exceed 0,6 seconds.
  - 2.5. In the case of motor vehicles having a brake coupling for trailers, in addition to the requirements of point 1.1 the reaction time shall be measured at the extremity of a pipe 2,5 m long with an internal diameter of 13 mm which shall be joined to the coupling head of the control line of the service braking system. During this test a volume of  $385 \pm 5 \text{ cm}^3$  (which is deemed to be equivalent to the volume of a pipe 2,5 m long with an internal diameter of 13 mm and under a pressure of 6,5 bar) shall be connected to the coupling head of the supply line.
 

Tractive units for semi-trailers shall be equipped with flexible pipes for making the connection to semi-trailers. The coupling heads will therefore be at the extremity of those flexible pipes. The length and internal diameter of the pipes is entered at point 2.6.3 of the test report (Annex IX, Appendix 2).
  - 2.6. The time which elapses between the start of the activation of the control pedal and the moment when the pressure measured at the coupling head of the control line reaches x % of its asymptotic value shall not exceed the values listed in the table below:

x (%)	t (seconds)
10	0,2
75	0,4

**▼M7**

- 2.7. In the case of motor vehicles authorised to tow trailers of category O<sub>3</sub> or O<sub>4</sub> fitted with compressed-air braking systems, in addition to the abovementioned requirements, the prescriptions in point 2.2.1.18.4.1 of Annex I shall be verified by conducting the following test:
- (a) by measuring the pressure at the extremity of a pipe 2,5 m long with an internal diameter of 13 mm which shall be joined to the coupling head of the supply line;
  - (b) by simulating a failure of the control line at the coupling head;
  - (c) by actuating the service braking system control device in 0,2 seconds, as described in point 2.3.
3. TRAILERS (including semi-trailers)
- 3.1. The reaction times for trailers shall be measured without a towing vehicle. To simulate the towing vehicle it is necessary to provide a simulator to which the coupling heads of the control line and of the supply line of the trailer are to be connected.
- 3.2. The pressure in the supply line shall be 6,5 bar.
- 3.3. The simulator shall have the following features:
- 3.3.1. It shall have a reservoir with a capacity of 30 litres which shall be charged to a pressure of 6,5 bar before each test and which shall not be recharged during each test. At the outlet of the braking control device the simulator shall incorporate an orifice with a diameter of from 4,0 to 4,3 mm inclusive. The volume of the pipe measured from the orifice up to and including the coupling head shall be  $385 \pm 5 \text{ cm}^3$  (which is deemed to be equivalent to the volume of a pipe 2,5 m long with an internal diameter of 13 mm and under a pressure of 6,5 bar). The control line pressures referred to in point 3.3.3 shall be measured immediately downstream of the orifice.
- 3.3.2. The braking system control shall be so designed that its performance in use is not affected by the tester.
- 3.3.3. The simulator shall be set, e.g. through the choice of orifice in accordance with point 3.3.1, in such a way that, if a reservoir of  $385 \pm 5 \text{ cm}^3$  is joined to it, the time taken for the pressure to increase from 0,65 to 4,9 bar (10 and 75 % respectively of the nominal pressure of 6,5 bar), shall be  $0,2 \pm 0,01$  seconds. If a reservoir of  $1\,155 \pm 15 \text{ cm}^3$  is substituted for the abovementioned reservoir, the time taken for the pressure to increase from 0,65 to 4,9 bar without further adjustment shall be  $0,38 \pm 0,02$  seconds. Between these two pressure values the pressure shall increase in an approximately linear way. These reservoirs shall be connected to the coupling head without using flexible pipes and shall have an internal diameter of not less than 10 mm.
- 3.3.4. The diagram in the Appendix to this Annex gives an example of the correct configuration and use of the simulator.
- 3.4. The time elapsing between the moment when the pressure produced in the control line by the simulator reaches 0,65 bar and the moment when the pressure in the brake actuator of the trailer reaches 75 % of its asymptotic value shall not exceed 0,4 seconds.
4. PRESSURE TEST CONNECTIONS
- 4.1. On each independent circuit of the braking system a pressure test connection shall be fitted at the closest readily accessible position to the brake cylinder which is the least favourably placed as far as reaction time is concerned.
- 4.2. The pressure test connections shall comply with clause 4 of ISO standard 3583-1984.



▼ M7

## Appendix

## EXAMPLE OF A SIMULATOR

(see Annex III, point 3)

## 1. Setting the simulator

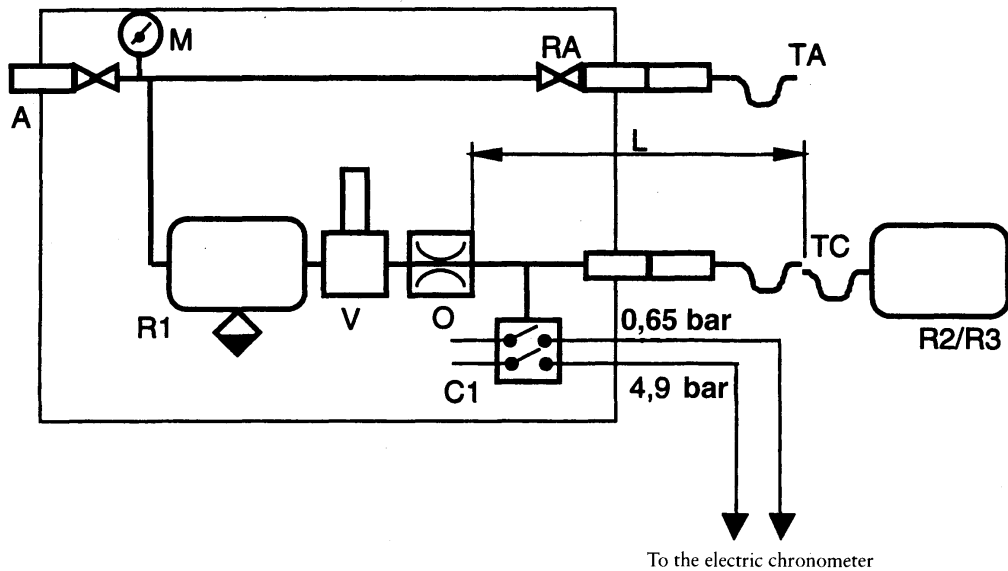

## 2. Testing the trailer braking system via the simulator

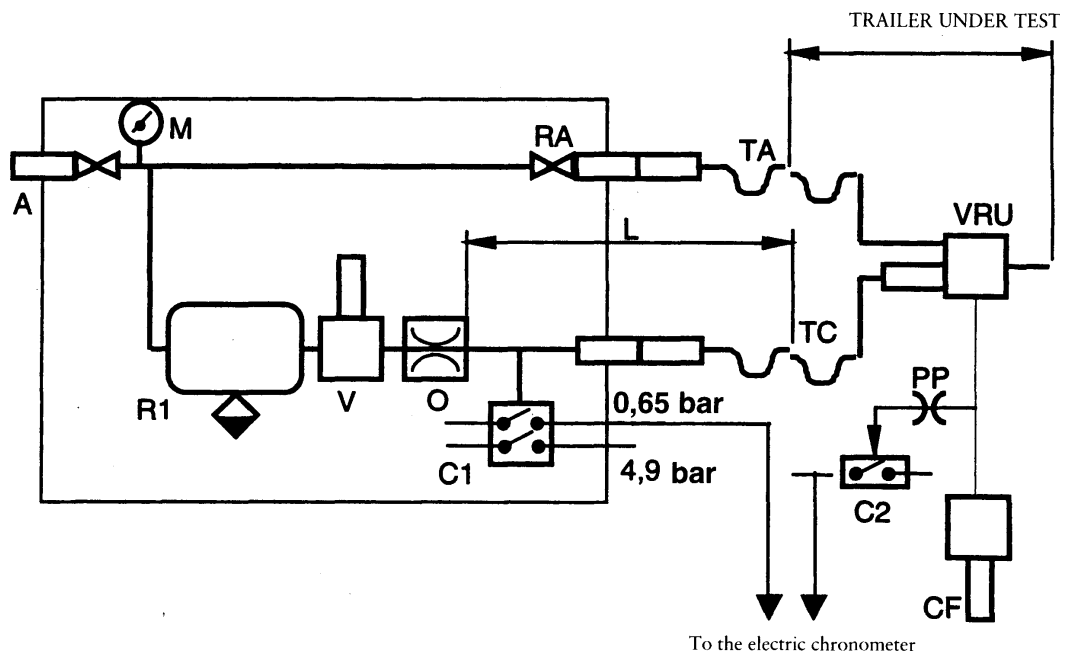

- A = supply connection with shut-off valve
- C1 = pressure switch in the simulator, set at 0,65 bar and at 4,9 bar
- C2 = pressure switch to be connected to the brake actuator of the trailer, to operate at 75 % of the asymptotic pressure in the brake actuator CF
- CF = brake actuator
- L = line from orifice O up to and including its coupling head TC, having an inner volume of  $385 \pm 5 \text{ cm}^3$  under pressure of 6,5 bar
- M = pressure gauge

**▼M7**

- O = orifice with a diameter of not less than 4 mm and not more than 4,3 mm
- PP = pressure test connection
- R1 = 30 litre air reservoir with drain valve
- R2 = calibrating reservoir, including its coupling head TC, to be  $385 \pm 5 \text{ cm}^3$
- R3 = calibrating reservoir, including its coupling head TC, to be  $1\,155 \pm 15 \text{ cm}^3$
- RA = shut-off valve
- TA = coupling head, supply line
- TC = coupling head, control line
- V = braking system control
- VRU = emergency relay valve

## ▼M7

## ANNEX IV

## Energy reservoirs and sources of energy

- A. *Compressed-air braking systems*
1. CAPACITY OF RESERVOIRS
- 1.1. *General requirements*
- 1.1.1. Vehicles on which the operation of the braking system depends on the use of compressed-air shall be fitted with reservoirs of a capacity meeting the requirements of points 1.2 and 1.3.
- 1.1.2. However, the reservoirs shall not be required to be of a prescribed capacity if the braking system is such that in the absence of any energy reserve it is possible to achieve a braking performance at least equal to that prescribed for the secondary braking system.
- 1.1.3. When verifying compliance with the requirements of points 1.2 and 1.3 the brakes shall be adjusted as closely as possible.
- 1.2. *Motor vehicles*
- 1.2.1. The air brake reservoirs of motor vehicles shall be so designed that after eight full-stroke actuations of the service braking system control, the pressure remaining in the air brake reservoir shall be not less than the pressure required to obtain the specified secondary braking performance.
- 1.2.2. During the test, the following requirements shall be satisfied:
- 1.2.2.1. The initial pressure in the reservoirs shall be that indicated by the manufacturer<sup>(1)</sup>. This pressure shall be such as to enable the prescribed performance for the service braking system to be achieved.
- 1.2.2.2. The reservoir or reservoirs shall not be replenished; in addition, the reservoir or reservoirs of auxiliary equipment shall be isolated.
- 1.2.2.3. In the case of motor vehicles authorised to tow a trailer, the supply line shall be blocked off and a reservoir of 0,5 litre capacity shall be connected to the control line. The pressure in this reservoir shall be exhausted before each actuation of the brakes. After the test referred to in point 1.2.1 the pressure in the control line shall not be less than one half of the pressure obtained at the first brake application.
- 1.3. *Trailers (including semi-trailers)*
- 1.3.1. Reservoirs fitted to trailers shall be such that after eight full-stroke actuations of the towing vehicle's service braking system, the pressure supplied to the operating parts using it does not fall below a level equivalent to one-half of the figure obtained at the first brake application and without actuating either the automatic or the parking braking system of the trailer.
- 1.3.2. During the test, the following requirements shall be satisfied:
- 1.3.2.1. The pressure in the reservoirs at the beginning of the test shall be 8,5 bar.
- 1.3.2.2. The supply line shall be blocked off; in addition, the auxiliary equipment reservoirs shall be isolated.
- 1.3.2.3. The reservoir shall not be replenished during the test.
- 1.3.2.4. For each brake application, the pressure in the control line shall be 7,5 bar.
2. CAPACITY OF ENERGY SOURCES
- 2.1. *General provisions*
- Compressors shall satisfy the requirements laid down in the following points:
- 2.2. *Definitions*

<sup>(1)</sup> The initial energy level shall be stated in the information document.

## ▼M7

- 2.2.1.  $p_1$  the pressure corresponding to 65 % of the pressure  $p_2$  defined in point 2.2.2.
- 2.2.2.  $p_2$  is the value specified by the manufacturer and referred to in point 1.2.2.1.
- 2.2.3.  $T_1$  is the time required for the relative pressure to rise from 0 to  $p_1$ ;  $T_2$  is the time required for the relative pressure to rise from 0 to  $p_2$ .
- 2.3. *Conditions of measurement*
- 2.3.1. In all cases the speed of the compressor shall be that obtained when the engine is running at the speed corresponding to its maximum power or at the speed allowed by the governor.
- 2.3.2. The auxiliary equipment reservoirs shall be isolated during the tests for determining the periods  $T_1$  and  $T_2$ .
- 2.3.3. On motor vehicles constructed to tow trailers, the trailer shall be represented by a reservoir whose maximum relative pressure  $p$  (expressed in bars) is that which can be supplied through the feed circuit of the towing vehicle and whose volume  $V$  (expressed in litres) is given by the formula  $p \times V = 20 R$  ( $R$  being the permissible maximum load, expressed in metric tonnes, on the axles of the trailer or semi-trailer).
- 2.4. *Interpretation of results*
- 2.4.1. The time  $T_1$  for the least efficient reservoir shall not exceed:
- three minutes in the case of vehicles to which the coupling of a trailer or semi-trailer is not authorised
  - six minutes in the case of vehicles to which the coupling of a trailer or semi-trailer is authorised.
- 2.4.2. The time  $T_2$  for the least efficient reservoir shall not exceed:
- six minutes in the case of vehicles to which the coupling of a trailer or semi-trailer is not authorised
  - nine minutes in the case of vehicles to which the coupling of a trailer or semi-trailer is authorised.
- 2.5. *Additional test*
- 2.5.1. When the vehicle is equipped with an auxiliary equipment reservoir or reservoirs with a total capacity exceeding 20 % of the total capacity of the brake reservoirs, an additional test shall be carried out during the course of which there shall be no interference with the functioning of the valves controlling the filling of the auxiliary equipment reservoir(s). A check shall be made during the course of this test that the period  $T_3$  required to bring about a rise in the pressure in the brake reservoirs from 0 to  $p_2$  is less than:
- eight minutes in the case of vehicles to which the coupling of a trailer or semi-trailer is not authorised
  - eleven minutes in the case of vehicles to which the coupling of a trailer or semi-trailer is authorised.
- 2.5.2. The test shall be performed in the conditions prescribed in points 2.3.1 and 2.3.3.
- 2.6. *Towing vehicles*
- 2.6.1. Vehicles to which the coupling of a category O vehicle is authorised shall also comply with the above requirements for vehicles not so authorised. In that case, the tests in points 2.4.1, 2.4.2 (and 2.5.1) will be conducted without the reservoir mentioned in item 2.3.3 of this Annex.
3. PRESSURE TEST CONNECTIONS
- 3.1. A pressure test connection shall be fitted at the closest readily accessible position to the least-favourably placed reservoir within the meaning of point 2.4 of this Annex.

▼ **M7**

- 3.2. The pressure test connections shall comply with clause 4 of ISO standard 3583-1984.
- B. *Vacuum braking systems***
1. CAPACITY OF RESERVOIRS
- 1.1. *General*
- 1.1.1. Vehicles on which the operation of the braking system requires the use of a vacuum shall be equipped with reservoirs of a capacity meeting the requirements of points 1.2 and 1.3 below.
- 1.1.2. However, the reservoirs shall not be required to be of a prescribed capacity if the braking system is such that in the absence of any energy reserve it is possible to achieve a braking performance at least equal to that prescribed for the secondary braking system.
- 1.1.3. In verifying compliance with the requirements of points 1.2 and 1.3 below, the brakes shall be adjusted as closely as possible.
- 1.2. *Motor vehicles*
- 1.2.1. The reservoirs of motor vehicles shall be such that it is still possible to achieve the performance prescribed for the secondary braking system
- 1.2.1.1. after eight full-stroke actuations of the service braking system control where the energy source is a vacuum pump; and
- 1.2.1.2. after four full-stroke actuations of the service braking system control where the energy source is the engine.
- 1.2.2. Testing shall be performed in conformity with the following requirements:
- 1.2.2.1. The initial energy level in the reservoir(s) shall be that specified by the manufacturer. It shall be such as to enable the prescribed service-braking performance to be achieved and shall correspond to a vacuum not exceeding 90 % of the maximum vacuum furnished by the energy source <sup>(1)</sup>;
- 1.2.2.2. The reservoir(s) shall not be fed; in addition, any reservoir(s) for auxiliary equipment shall be isolated.
- 1.2.2.3. In the case of motor vehicles authorised to tow a trailer, the supply line shall be blocked off and a reservoir of 0,5 litre capacity shall be connected to the control line. After the test referred to in point 1.2.1, the vacuum level provided at the control line shall not have fallen below a level equivalent to one-half of the figure obtained at the first brake application.
- 1.3. *Trailers (category O<sub>1</sub> and O<sub>2</sub> only)*
- 1.3.1. The reservoir(s) with which trailers are equipped shall be such that the vacuum level provided at the user points shall not have fallen below a level equivalent to one-half of the value obtained at the first brake application after a test comprising four full-stroke actuations of the trailer's service braking system.
- 1.3.2. Testing shall be performed in conformity with the following requirements:
- 1.3.2.1. The initial energy level in the reservoir(s) shall be that specified by the manufacturer. It shall be such as to enable the prescribed service braking performance to be achieved<sup>1</sup>.
- 1.3.2.2. The reservoir(s) shall not be fed; in addition, any reservoir(s) for auxiliary equipment shall be isolated.
2. CAPACITY OF ENERGY SOURCES
- 2.1. *General*
- 2.1.1. Starting from the ambient atmospheric pressure, the energy source shall be capable of achieving in the reservoir(s) in three minutes, the initial level specified in point 1.2.2.1. In the case of a motor

<sup>(1)</sup> The initial energy level shall be stated in the information document.

▼ **M7**

vehicle to which the coupling of a trailer is authorised, the time taken to achieve that level in the conditions specified in point 2.2 shall not exceed six minutes.

- 2.2. *Conditions of measurement*
- 2.2.1. The speed of the vacuum source shall be:
- 2.2.1.1. Where the vacuum source is the vehicle engine, the engine speed obtained with the vehicle stationary, the neutral gear engaged and the engine idling;
- 2.2.1.2. where the vacuum source is a pump, the speed obtained with the engine running at 65 % of the speed corresponding to its maximum power output; and
- 2.2.1.3. where the vacuum source is a pump and the engine is equipped with a governor, the speed obtained with the engine running at 65 % of the maximum speed allowed by the governor.
- 2.2.2. Where it is intended to couple to the motor vehicle a trailer whose service braking system is vacuum-operated, the trailer shall be represented by an energy storage device having a capacity V in litres determined by the formula:

$$V = 15 \times R$$

where R is the maximum permissible mass, in metric tonnes, on the axles of the trailer.

C. *Hydraulic braking systems with stored energy*

1. CAPACITY OF STORAGE DEVICES (ENERGY ACCUMULATORS)
- 1.1. *General*
- 1.1.1. Vehicles on which the operation of the braking system requires the use of stored energy provided by hydraulic fluid under pressure shall be equipped with energy storage devices (energy accumulators) of a capacity meeting the requirements of point 1.2 below.
- 1.1.2. However, the energy storage devices shall not be required to be of a prescribed capacity if the braking system is such that in the absence of any energy reserve it is possible with the service braking system control to achieve a braking performance at least equal to that prescribed for the secondary braking system.
- 1.1.3. In verifying compliance with the requirements of points 1.2.1, 1.2.2 and 2.1 below, the brakes shall be adjusted as closely as possible and, for point 1.2.1, the rate of full-stroke actuations shall be such as to provide an interval of at least one minute between each actuation.
- 1.2. *Motor vehicles*
- 1.2.1. Motor vehicles equipped with a hydraulic braking system with stored energy shall meet the following requirements:
- 1.2.1.1. After eight full-stroke actuations of the service braking system control, it shall still be possible to achieve, on the ninth application, the performance prescribed for the secondary braking system.
- 1.2.1.2. Testing shall be performed in conformity with the following requirements:
- 1.2.1.2.1. Testing shall commence at a pressure that may be specified by the manufacturer but is not higher than the cut-in pressure.
- 1.2.1.2.2. The accumulator(s) shall not be fed; in addition, any accumulator(s) for auxiliary equipment shall be isolated.
- 1.2.2. Motor vehicles equipped with a hydraulic braking system with stored energy which cannot meet the requirements of point 2.2.1.5.1 of Annex I shall be deemed to satisfy that point if the following requirements are met:

**▼M7**

- 1.2.2.1. After any single transmission failure it shall still be possible after eight full-stroke actuations of the service braking system control, to achieve, at the ninth application, at least the performance prescribed for the secondary braking system or, where secondary performance requiring the use of stored energy is achieved by a separate control, it shall still be possible after eight full-stroke actuations to achieve, at the ninth application, the residual performance prescribed in point 2.2.1.4 of Annex I.
- 1.2.2.2. Testing shall be performed in conformity with the following requirements:
- 1.2.2.2.1. with the energy source stationary or operating at a speed corresponding to the engine idling speed, any transmission failure may be induced. Before inducing such a failure the energy storage device(s) shall be at a pressure that may be specified by the manufacturer but not exceeding the cut-in pressure.
- 1.2.2.2.2. The auxiliary equipment and its accumulators, if any, shall be isolated.
2. CAPACITY OF HYDRAULIC FLUID ENERGY SOURCES
- 2.1. The energy sources shall meet the requirements set out in the following paragraphs:
- 2.1.1. Definitions
- 2.1.1.1. ‘ $p_1$ ’ represents the maximum system operational pressure (cut-out pressure) in the accumulator(s) specified by the manufacturer.
- 2.1.1.2. ‘ $p_2$ ’ represents the pressure after four full-stroke actuations with the service braking system control, starting at  $p_1$ , without having fed the accumulator(s).
- 2.1.1.3. ‘ $t$ ’ represents the time required for the pressure to rise from  $p_2$  to  $p_1$  in the accumulator(s) without application of the service braking system control.
- 2.1.2. Conditions of measurement
- 2.1.2.1. During the test to determine the time  $t$ , the feed rate of the energy source shall be that obtained when the engine is running at the speed corresponding to its maximum power or at the speed allowed by the governor.
- 2.1.2.2. During the test to determine the time  $t$ , accumulator(s) for auxiliary equipment shall not be isolated other than automatically.
- 2.1.3. Interpretation of results
- 2.1.3.1. In the case of all vehicles except those of categories  $M_3$ ,  $N_2$  and  $N_3$ , the time  $t$  shall not exceed 20 seconds.
- 2.1.3.2. In the case of vehicles of categories  $M_3$ ,  $N_2$  and  $N_3$ , the time  $t$  shall not exceed 30 seconds.
3. CHARACTERISTICS OF ALARM DEVICES
- With the engine stationary and commencing at a pressure that may be specified by the manufacturer but does not exceed the cut-in pressure, the alarm device shall not operate following two full-stroke actuations of the service braking system control.

## ▼M7

## ANNEX V

**Spring brakes**

1. DEFINITIONS
  - 1.1. ‘Spring brakes’ are braking devices for which the energy required for braking is supplied by one or more springs acting as an energy accumulator.
    - 1.1.1. The energy necessary to compress the spring in order to release the brake shall be supplied and controlled by the ‘control’ actuated by the driver (see definition in point 1.4 of Annex I).
  - 1.2. ‘Spring compression chamber’ means the chamber where the pressure variation that induces the compression of the spring is actually produced.
  - 1.3. If the compression of the springs is obtained by means of a vacuum device, ‘pressure’ shall mean negative pressure everywhere in this Annex.
2. GENERAL REQUIREMENTS
  - 2.1. A spring brake shall not be used as a service brake. However, in the event of a failure in a part of the transmission of the service braking system, a spring brake may be used to achieve the residual performance prescribed in point 2.2.1.4 of Annex I, provided that the driver can graduate this action. In the case of motor vehicles, with the exception of towing vehicles for semi-trailers meeting the requirements specified in point 2.2.1.4.3 of Annex I, the spring brake shall not be the sole source of residual braking. Vacuum spring brakes shall not be used for trailers.
  - 2.2. A small variation in any of the pressure limits which may occur in the spring compression chamber feed circuit shall not cause a significant variation in the braking force.
  - 2.3. The feed circuit to the spring compression chamber shall either include an own energy reserve or shall be fed from at least two independent energy reserves. The trailer supply line may be branched from this feed line under the condition that a pressure drop in the trailer supply line shall not be able to apply the spring brake actuators. Auxiliary equipment may only draw its energy from the feed line for the spring brake actuators under the condition that its operation, even in the event of damage to the energy source, cannot cause the energy reserve for the spring brake actuators to fall below a level from which one release of the spring brake actuators is possible. In any case during re-charging of the braking system from zero pressure, the spring brakes shall not release until the pressure in the service braking system is sufficient to ensure at least the prescribed secondary braking performance of the laden vehicle, using the service braking system control. Similarly, once applied, the spring brakes shall not release unless there is sufficient pressure in the service braking system to at least provide the prescribed residual braking performance of the laden vehicle by application of the service braking control.  
  
This item does not apply to trailers.
  - 2.4. In motor vehicles, the system shall be so designed that it is possible to apply and release the brakes at least three times if the initial pressure in the spring compression chamber is equal to the maximum design pressure. In the case of trailers, it shall be possible to release the brakes at least three times after the trailer has been uncoupled, the pressure in the supply line being 6,5 bar before the uncoupling. These conditions shall be satisfied when the brakes are adjusted as closely as possible. In addition, it shall be possible to apply and release the parking brake as specified in Annex I point 2.2.2.10, when the trailer is coupled to the towing vehicle.
  - 2.5. In the case of motor vehicles, the pressure in the spring compression chamber beyond which the springs begin to actuate the brakes, the latter being adjusted as closely as possible, shall



▼ M7

not be greater than 80 % of the minimum level of the normal available pressure. In the case of trailers, the pressure in the spring compression chamber beyond which the springs begin to actuate the brakes shall not be greater than that obtained after four full-stroke actuations of the service braking system in accordance with Annex IV, point 1.3. The initial pressure is fixed at 6,5 bar.

- 2.6. When the pressure in the line feeding energy to the spring compression chamber — excluding lines of an auxiliary release device using a fluid under pressure — falls to the level at which the brake parts begin to move, an optical or audible warning device shall be actuated. Provided this requirement is met, the warning device may be that specified in point 2.2.1.13 of Annex I. This provision does not apply to trailers.
- 2.7. On motor vehicles fitted with spring brakes and authorised to tow trailers with continuous or semi-continuous brakes, automatic application of the spring brakes shall cause the trailer brakes to be applied.
3. RELEASE SYSTEM
- 3.1. A spring braking system shall be so designed that, in the event of a failure in that system, it is still possible to release the brakes. This may be achieved by the use of an auxiliary release device (pneumatic, mechanical, etc.). Auxiliary release devices using an energy reserve for releasing, shall draw their energy from an energy reserve which is independent from the energy reserve normally used for the spring braking system.
- The pneumatic or hydraulic fluid in such an auxiliary release device may act on the same piston surface in the spring compression chamber, which is used for the normal spring braking system, under the condition that the auxiliary release device uses a separate line. The junction of this line with the normal line connecting the control device with the spring brake actuators, shall be at each spring brake actuator immediately before the port to the spring compression chamber, if not integrated in the body of the actuator. This junction shall include a device which prevents an influence of one line on the other. The requirements of point 2.2.1.6 of Annex I also apply to this device.
- 3.1.1. For the purposes of the requirement of point 3.1, components of the braking system transmission shall not be regarded as subject to failure if under the terms of point 2.2.1.2.7 of Annex I they are not regarded as liable to breakage, provided that they are made of metal or of a material having similar characteristics and do not undergo significant distortion in normal braking.
- 3.2. If the operation of the auxiliary device referred to in point 3.1 requires the use of a tool or spanner, that tool or spanner shall be kept on the vehicle.

**▼M7***ANNEX VI***Parking braking by mechanical locking of the brake cylinders (lock actuators)**

## 1. DEFINITION

Mechanical locking of the brake cylinders means a device for ensuring parking braking by mechanical wedging of the brake piston rod.

Mechanical locking occurs when the locking chamber is emptied of compressed air; the mechanical locking device shall be designed in such a way that it can be released when the locking chamber is again subjected to pressure.

## 2. SPECIAL PROVISIONS

## 2.1. When the pressure in the locking chamber approaches the level corresponding to mechanical locking, an optical or audible warning system shall be actuated.

This provision does not apply to trailers. In the case of trailers the pressure corresponding to mechanical locking shall not exceed 4 bar. It shall be possible to achieve parking brake performance after any single failure of the trailer service braking system. In addition, it shall be possible to release the brakes at least three times after the trailer has been uncoupled, the pressure in the supply line being 6,5 bar before the uncoupling. These conditions shall be satisfied when the brakes are adjusted as closely as possible. It shall also be possible to apply and release the parking braking system as specified in Annex I, point 2.2.2.10, when the trailer is coupled to the towing vehicle.

## 2.2. In the case of brake actuators fitted with a mechanical locking device, the brake actuator shall be capable of being actuated by either of two energy reserves.

## 2.3. The locked brake cylinder may only be released if it is certain that the brake can be operated again after such release.

## 2.4. In the event of a failure of the source of energy supplying the locking chamber, an auxiliary unlocking device (mechanical or pneumatic, for instance) using, for example, the air in one of the tyres of the vehicle, shall be provided.

## 2.5. The control shall be such that, when actuated, it performs the following operations in sequence: it applies the brakes so as to provide the degree of efficiency required for parking braking, locks the brakes in that position and then cancels out the brake-application force.

▼ M7

## ANNEX VII

**Cases in which Type I and/or II (or IIA) or III tests do not have to be carried out on a vehicle submitted for type-approval**

1. Type I and/or II (or IIA) or Type III tests shall not have to be carried out on a vehicle submitted for type-approval in the following cases:
  - 1.1. Where the vehicle in question is a motor vehicle, a trailer or a semi-trailer which, in respect of tyres, braking energy absorbed by each axle and method of fitting of tyres and brakes, is identical, as far as braking is concerned, to a motor vehicle, or trailer, or semi-trailer which:
    - 1.1.1. has passed a Type I and/or II (or IIA) or III test
    - 1.1.2. has been type-approved, with regard to braking energy absorbed, for mass per axle not lower than that of the vehicle concerned.
  - 1.2. Where the vehicle in question is a motor vehicle, a trailer or a semi-trailer of which the axle or axles, in respect of tyres, braking energy absorbed by each axle and method of fitting tyres and brakes, is or are identical, as far as braking is concerned, to an axle or axles which has or have individually passed a Type I and/or II (or IIA) or Type III test for mass per axle not lower than that of the vehicle concerned, provided that the braking energy absorbed by each axle does not exceed the energy absorbed by that axle during the reference test or tests carried out separately on that axle.
  - 1.3. Where the vehicle submitted for type-approval is fitted with a retarder, other than an engine brake, identical to a retarder which has already been tested under the following conditions:
    - 1.3.1. In a test carried out on a gradient of at least 6 % (Type II test) or of at least 7 % (Type IIA test), this retarder has, on its own, stabilised the speed of a vehicle with a maximum mass at the time of testing at least equal to the maximum mass of the vehicle submitted for type-approval.
    - 1.3.2. During the above test it shall be verified that the speed of rotation of the revolving parts of the retarder is such that, when the vehicle is travelling at a speed of 30 km/h, the retarding torque is at least equal to the retarding torque in the test mentioned in point 1.3.1.
  - 1.4. Where the vehicle concerned is a trailer equipped with 'S'-cam air-operated brakes <sup>(1)</sup> which satisfies the verification requirements of Appendix I to this Annex relating to a report of a reference axle test as shown in Appendix 2 of this Annex.
2. The term 'identical' as used in points 1.1, 1.2 and 1.3 means identical as regards the geometrical and mechanical characteristics of the vehicle parts mentioned in those items, and also as regards the characteristics of the materials from which these parts are made.
3. When advantage is taken of the above provisions, the type-approval communication in respect of braking (Annex IX, Appendix 2) shall contain the following particulars:
  - 3.1. Where point 1.1 is applicable, the type of the approval number of the vehicle on which the Type I and/or II (or IIA) or III test serving as a reference test has been carried out (point 2.7.1).
  - 3.2. Where point 1.2 is applicable, the table in point 2.7.2 shall be completed.
  - 3.3. Where point 1.3 is applicable, the table in point 2.7.3 shall be completed.
  - 3.4. Where point 1.4 is applicable, the table in point 2.7.4 shall be completed.

<sup>(1)</sup> Other brake designs may be approved upon presentation of equivalent information.

▼ M7

4. When a person applying for type-approval in a Member State refers to a type-approval granted in another Member State, that person shall produce the documents relating to such approval.

▼ M7*Appendix 1***Alternative procedures for Type I and Type III tests for trailer brakes**

1. GENERAL
  - 1.1. In accordance with point 1.4 of this Annex, the Type I and Type III fade tests may be waived at the time of type-approval of the vehicle provided that the braking system components comply with the requirements of this Appendix and that the resulting predicted brake performance meets the prescriptions of this Directive for the appropriate vehicle category.
  - 1.2. Tests carried out in accordance with the methods detailed in this Appendix shall be deemed to meet the above requirements.
2. SYMBOLS AND DEFINITIONS (the reference brake symbols shall have the 'e')

P	=	normal reaction of road surface on the axle under static conditions
C	=	camshaft input torque
$C_{\max}$	=	maximum technically permissible camshaft input torque
$C_0$	=	threshold camshaft input torque, i.e. minimum camshaft torque necessary to produce a measurable brake torque
R	=	tyre rolling radius (dynamic)
T	=	brake force at tyre/road interface
M	=	brake torque = $T \times R$
z	=	braking rate $T/P = M/RP$
s	=	actuator stroke (working stroke plus free stroke)
$s_p$	=	effective stroke — the stroke at which the output thrust is 90 % of the average thrust ( $Th_A$ )
$Th_A$	=	average thrust — the average thrust shall be determined by integrating the values between one-third and two-thirds of the total stroke ( $s_{\max}$ ).

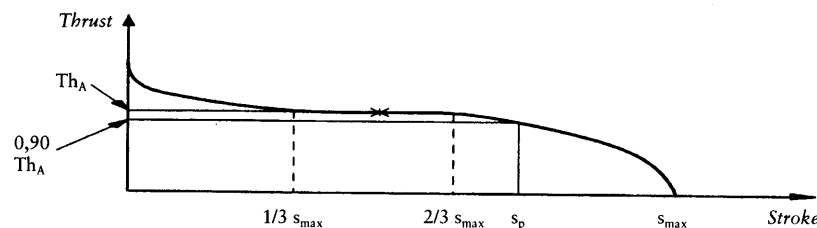

l	=	lever length
r	=	radius of brake drum
p	=	brake actuation pressure

3. TEST METHODS
  - 3.1. *Track tests*
    - 3.1.1. The brake performance tests should preferably be carried out on a single axle only.
    - 3.1.2. The results of tests on a combination of axles may be used in accordance with point 1.1 provided that each axle contributes equal braking energy input during the drag and hot brake tests.
      - 3.1.2.1. This is ensured if the following are identical for each axle: brake geometry (Figure 2), lining, wheel mounting, tyres, actuation and pressure distribution in the actuators.

▼ **M7**

- 3.1.2.2. The result recorded for a combination of axles will be the average value for these axles.
- 3.1.3. The axle(s) should preferably be loaded with the maximum static axle load, though this is not essential provided that due allowance is made during the tests for the difference in rolling resistance caused by a different load on the test axle(s).
- 3.1.4. Allowance shall be made for the effect of the increased rolling resistance resulting from a combination of vehicles being used to carry out the tests.
- 3.1.5. The initial speed of the test is prescribed. The final speed shall be calculated by the following formula:

$$v_2 = v_1 \sqrt{2 \frac{P_0 + P_1}{P_0 + P_1 + P_2}}$$

where

- $v_1$  = initial speed (km/h)
- $v_2$  = final speed (km/h)
- $P_0$  = mass of the towing vehicle (kg) under test conditions
- $P_1$  = mass of the trailer borne by the non-braked axle(s) (kg)
- $P_2$  = mass of the trailer borne by the braked axle(s) (kg).

3.2. *Inertia dynamometer tests*

- 3.2.1. The test machine shall have a rotary inertia simulating that part of the linear inertia of the vehicle mass acting upon one wheel, necessary for the cold performance and hot performance tests, and capable of being operated at constant speed for the purpose of the test described in points 3.5.2 and 3.5.3.
- 3.2.2. The test shall be carried out with a complete wheel, including the tyre, mounted on the moving part of the brake, as it would be on the vehicle. The inertia mass may be connected to the brake either directly or via the tyres and wheels.
- 3.2.3. Air cooling at a velocity and air flow direction simulating actual conditions may be used during the heating runs, the speed of air flow being not greater than 10 km/h. The temperature of the cooling air shall be the ambient temperature.
- 3.2.4. Where the tyre rolling resistance is not automatically compensated for in the test, the torque applied to the brake shall be modified by subtracting a torque equivalent to a rolling resistance coefficient of 0,01.

3.3. *Rolling road dynamometer tests*

- 3.3.1. The axle should preferably be loaded with the maximum static axle load, though this is not essential provided that due allowance is made during the tests for the difference in rolling resistance caused by a different mass on the test axle.
- 3.3.2. Air cooling at a velocity and air flow direction simulating actual conditions may be used during the heating runs, the speed of air flow being not greater than 10 km/h. The temperature of the cooling air shall be the ambient temperature.
- 3.3.3. The braking time has a duration of 1 second after a maximum build-up time of 0,6 seconds.

3.4. *Test conditions*

- 3.4.1. The test brake(s) shall be instrumented so that the following measurements can be taken:
- 3.4.1.1. A continuous recording to enable the brake torque or force at the periphery of the tyre to be determined.
- 3.4.1.2. A continuous recording of air pressure in the brake actuator.
- 3.4.1.3. Speed during the test.

▼ M7

- 3.4.1.4. Initial temperature on the outside of the brake drum.
- 3.4.1.5. Brake actuator stroke used during the Type 0 test and Type I or Type III tests as applicable.

3.5. *Test procedures*

## 3.5.1. Supplementary cold performance test

- 3.5.1.1. This test shall be carried out at an initial speed equivalent to 40 km/h in the case of Type I test and 60 km/h in the case of Type III test in order to evaluate the hot braking performance at the end of Type I and Type III tests.

- 3.5.1.2. Three brake applications shall be made at the same pressure (p) and at an initial speed equivalent to 40 km/h (in the case of Type I test) or to 60 km/h (in the case of Type III test), with an approximately equal initial brake temperature not exceeding 100 °C, measured at the outside surface of the drum. The applications are at the brake actuator pressure required to give a brake torque or force equivalent to a braking rate (z) of at least 0,50. The brake actuator pressure shall not exceed 6,5 bar, and the camshaft input torque (C) shall not exceed the maximum technically permissible camshaft input torque (C<sub>max</sub>). The average of the three results shall be taken as the cold performance.

## 3.5.2. Type I test

- 3.5.2.1. This test shall be carried out at a speed equivalent to 40 km/h with an initial brake temperature not exceeding 100 °C, measured at the outside surface of the drum.

- 3.5.2.2. A braking rate shall be maintained at 0,07 including the rolling resistance (see point 3.2.4).

- 3.5.2.3. The duration of the test shall be two minutes and 33 seconds or 1,7 km at 40 km/h. If the test velocity cannot be achieved then the duration of the test can be lengthened according to point 1.3.2.2. of Annex II.

- 3.5.2.4. Not later than 60 seconds after the end of the Type I fade test, a hot performance test shall be carried out in accordance with point 1.3.3 of Annex II at an initial speed equivalent to 40 km/h. The brake actuator pressure shall be that used during the cold performance test.

## 3.5.3. Type III test (fade test)

- 3.5.3.1. Test methods for repeated braking.

- 3.5.3.1.1. Track tests (see Annex II, point 1.6).

- 3.5.3.1.2. Inertia dynamometer test.

For the bench test as in Annex VII, Appendix 1, point 3.2, the conditions may be as for the road test according to Annex II point 1.6.1 where

$$v_2 = \frac{v_1}{2}$$

- 3.5.3.1.3. Rolling road dynamometer test

For the bench test as in Annex VII, Appendix 1, point 3.3, the conditions shall be as follows:

Number of brake applications	20
Duration of braking cycle (braking time 25 seconds and recovery time 35 seconds)	60 seconds
Test speed	30 km/h
Braking rate	0,06
Rolling resistance	0,01.

## ▼M7

3.5.3.2. Not later than 60 seconds after the end of the Type III test a hot performance test shall be carried out in accordance with point 1.6.2 of Annex II to this Directive. The brake actuator pressure shall be that used during the Type 0 test.

3.6. *Test report*

3.6.1. The result of tests carried out in accordance with point 3.5 shall be reported on a form, a model of which is shown in Appendix 2 to this Annex.

3.6.2. The brake and the axle shall be identified. Particulars of the brakes, the axle, the technically permissible mass and the number of the corresponding test report shall be marked on the axle.

#### 4. VERIFICATION

##### 4.1. *Verification of components*

The brake specification of the vehicle to be type-approved shall be verified by satisfying each of the following criteria:

	Item	Criteria
4.1.1.	(a) Brake drum cylindrical section	No change allowed
	(b) Brake drum material	No change allowed
	(c) Brake drum mass	May change between - 0 and + 20 % of the reference drum mass
4.1.2.	(a) Proximity of wheel to outside surface of brake drum (dimension E)	Tolerances to be determined by the technical service conducting the approval tests
	(b) Part of brake drum not covered by wheel (dimension F)	
4.1.3.	(a) Brake lining material	No change allowed
	(b) Brake lining width	
	(c) Brake lining thickness	
	(d) Brake lining actual surface	
	(e) Brake lining method of attachment	
4.1.4.	Brake geometry (Figure 2)	No change allowed
4.1.5.	Tyre rolling radius (R)	May change subject to the requirements of point 4.3.1.4 of this Appendix
4.1.6.	(a) Average thrust (TH <sub>A</sub> )	May change provided that the predicted performance meets the requirements of point 4.3 of this Appendix
	(b) Actuator stroke (s)	
	(c) Lever length	
	(d) Brake actuation pressure (p)	
4.1.7.	Static mass (P)	P shall not exceed P <sub>c</sub> (see point 2)

##### 4.2. *Verification of brake forces developed*

4.2.1. The brake forces (T) for each subject brake (for the same control line pressure p<sub>m</sub>) necessary to produce the drag force specified for both Type I and Type III test conditions shall not exceed the values T<sub>c</sub> as stated in the Record of Test Results, Appendix 2, point 2 of this Annex, which were taken as a basis for the test of the reference brake.

##### 4.3. *Verification of hot performance*

4.3.1. The brake force (T) for each subject brake for a specified pressure (p) in the actuators and control line pressure (p<sub>m</sub>) used during the Type 0 test if the subject trailer shall be determined by the methods described in items points 4.3.1.1 to 4.3.1.4.



**▼M7**

- 4.3.1.1. The predicted actuator stroke (s) of the subject brake shall be determined from the following relationship:

$$s = l \times \frac{s_e}{l_e}$$

s shall not exceed the effective stroke ( $s_p$ ).

- 4.3.1.2. The average thrust output ( $Th_A$ ) of the actuator fitted to the subject brake at the pressure specified in point 4.3.1 shall be determined.

- 4.3.1.3. The camshaft input torque (C) shall be then given by

$$C = Th_A \times l$$

C shall not exceed  $C_{max}$ .

- 4.3.1.4. The predicted brake performance for the subject brake shall be given by

$$T = (T_e - 0,01P_e) \times \frac{(C - C_o)}{(C_e - C_{oe})} \times \frac{R_e}{R} + 0,01P$$

R shall not be less than  $0,8 R_e$ .

- 4.3.2. The predicted brake performance for the subject trailer shall be given by:

$$\frac{TR}{PR} = \frac{\Sigma T}{\Sigma P}$$

- 4.3.3. The hot performances following the Type I or Type III tests shall be determined in accordance with points 4.3.1.1, 4.3.1.2, 4.3.1.3 and 4.3.1.4. The resulting predictions given by point 4.3.2 shall satisfy the requirements of this Directive for the subject trailer. The value used for the 'figure recorded in the Type 0 test', as prescribed in Annex II, point 1.3.3 of 1.6.2 shall be the figure recorded in the Type 0 test of the subject trailer.

▼ **M7***Appendix 2***Model reference axle test report form as prescribed in Appendix 1, point 3.6**

Test report No

**1. IDENTIFICATION****1.1. Axle**

Manufacturer (name and address)  
 Make  
 Type  
 Model  
 Technically permissible axle load ( $P_e$ ) in (daN)

**1.2. Brake**

Manufacturer (name and address)  
 Make  
 Type  
 Model  
 Technically permissible camshaft input torque  $C_{max}$   
 Brake drum: Internal diameter  
 Mass  
 Material (attach dimensioned drawing as in Figure 1)  
 Brake lining: Manufacturer  
 Type  
 Identification (shall be visible when the lining is mounted on the brake shoe)  
 Width  
 Thickness  
 Surface area  
 Method of attachment  
 Brake geometry (attach dimensioned drawing as in Figure 2)

**1.3. Wheel(s)**

Single/twin <sup>(1)</sup>  
 Prim diameter (D)  
 (attach dimensioned drawing as in Figure 1)

**1.4. Tyres**

Dynamic rolling radius ( $R_c$ ) at reference load ( $P_e$ )

**1.5. Actuation**

Manufacturer  
 Type (cylinder/diaphragm) <sup>(1)</sup>  
 Model  
 Lever length (l)

**2. RECORD OF TEST RESULTS (Corrected to take account of rolling resistance,  $0,01 \times P_e$ ) <sup>(2)</sup>****2.1. In the case of vehicles of categories O<sub>2</sub> and O<sub>3</sub>**

Test type: Annex VII, Appendix 1, point	0	I	
	3.5.1.2	3.5.2.2/3	3.5.2.4
Test speed (km/h)	40	40	40
Brake actuator pressure $P_e$ (bar)		—	—

<sup>(1)</sup> Delete where not applicable.<sup>(2)</sup> Indicate as applicable, track test/inertia dynamometer test/rolling road dynamometer test.

## ▼M7

Test type: Annex VII, Appendix 1, point	0 3.5.1.2	I	
		3.5.2.2/3	3.5.2.4
Braking time (min)	—	2,55	—
Brake force developed $T_e$ (daN)			
Brake efficiency $T_e/P_e$ —			
Actuator stroke $s_e$ (mm)		—	
Camshaft input torque $C_e$ (Nm)			—
$C_{o,e}$ (Nm)		—	

2.2. *In the case of vehicles of category O<sub>4</sub>*

Test type: Annex VII, Appendix 1, point	0 3.5.1.2	III	
		3.5.3.1	3.5.3.2
Test speed initial (km/h)	60		60
Test speed final (km/h)			
Brake actuator pressure $P_e$ (bar)		—	
Number of brake applications —	—	20	—
Duration of braking cycle (s)	—	60	—
Brake force developed $T_e$ (daN)			
Brake efficiency $T_e/P_e$ —			
Actuator stroke $s_e$ (mm)		—	
Camshaft input torque $C_e$ (Nm)		—	
$C_{o,e}$ (Nm)		—	

3. NAME OF TECHNICAL SERVICE CONDUCTING THE TEST

4. DATE OF TEST

5. This test has been carried out and the result reported in accordance with Directive 71/320/EEC as last amended by Directive 98/12/EC and Annex VII, Appendix 1.

Technical service/approval authority conducting the test:

.....

Signed Date

6. Approval authority, if different from the technical service:

.....

Signed Date

(1) Delete where not applicable.





▼ M7

## ANNEX VIII

**Conditions governing the testing of vehicles with inertia (overrun) braking systems**

1. GENERAL PROVISIONS
  - 1.1. The 'inertia (overrun) braking system' of a trailer comprises the control device, the transmission and the brake, as defined in point 1.4.
  - 1.2. The 'control device' is the combination of components comprising the coupling head.
  - 1.3. The 'transmission' is the combination of components comprised between the coupling head and the first part of the brake.
  - 1.4. The 'brake' is the part in which the forces opposing the movement of the vehicle develop. The first part of the brake is either the lever actuating the brake cam or similar parts (mechanical-transmission inertia brake) or the brake cylinder (hydraulic-transmission inertia brake).
  - 1.5. Braking systems in which accumulated energy (for instance, electric, pneumatic or hydraulic) is transmitted to the trailer by the towing vehicle and is only controlled by the force at the coupling shall not be deemed to be inertia braking systems within the meaning of this Directive.
  - 1.6. *Tests*
    - 1.6.1. Determination of the main characteristics of the brake.
    - 1.6.2. Determination of the main characteristics of the control device and testing as to whether that device conforms with the provisions of this Directive.
    - 1.6.3. Testing on the vehicle:
      - the compatibility of the control device and the brake
      - the transmission.
2. SYMBOLS AND DEFINITIONS
  - 2.1. *Units used*
    - 2.1.1. Masses: kg
    - 2.1.2. Forces: N
    - 2.1.3. Torques and moments: Nm
    - 2.1.4. Areas: cm<sup>2</sup>
    - 2.1.5. Pressures: bar
    - 2.1.6. Lengths: units specified in each case.
    - 2.1.7. Acceleration due to gravity:  $g = 10 \text{ m/s}^2$ .
  - 2.2. *Symbols valid for all types of braking systems* (see diagram 1 in Appendix 1)
    - 2.2.1.  $G_A$ : 'maximum mass' of the trailer declared to be technically permissible by the manufacturer
    - 2.2.2.  $G_A$ : 'maximum mass' of the trailer which, according to the manufacturer's declaration, can be braked by the control device
    - 2.2.3.  $G_B$ : 'maximum mass' of the trailer which can be braked by the joint operation of all the trailer brakes

$$G_B = n \times G_{B_0}$$

▼ **M7**

- 2.2.4.  $G_{Bo}$ : fraction of the permissible ‘maximum mass’ which, according to the manufacturer's declaration, can be braked by one brake
- 2.2.5.  $B^*$ : braking force required
- 2.2.6.  $B$ : required braking force taking account of rolling resistance
- 2.2.7.  $D^*$ : permitted thrust on coupling
- 2.2.8.  $D$ : load on the coupling
- 2.2.9.  $P'$ : control device output force
- 2.2.10.  $K$ : supplementary force of control device by convention; this is defined as the force  $D$  corresponding to the point of intersection of the x axes of the extrapolated curve expressing  $P'$  in terms of  $D$ , measured with the control system in the mid-travel position (see diagrams 2 and 3 in Appendix 1)
- 2.2.11.  $K_A$ : threshold force of control device — this is the maximum force on the coupling head which can be applied for a short period of time without producing any output force on the control device. By convention,  $K_A$  is defined as the force measured when force begins to be exerted on the coupling head at a speed of from 10 to 15 mm/s, the control device transmission being uncoupled
- 2.2.12.  $D_1$ : this is the maximum force applied to the coupling head when it is forced rearward at a speed of  $s$  mm/s  $\pm 10\%$ , the transmission being uncoupled
- 2.2.13.  $D_2$ : This is the maximum force applied to the coupling head when this is pulled forward at a speed of  $s$  mm/s  $\pm 10\%$  from its rearmost position, the transmission being uncoupled
- 2.2.14.  $\eta H_0$ : efficiency of the inertia control device
- 2.2.15.  $\eta H_1$ : efficiency of the transmission system
- 2.2.16.  $\eta H$ : total efficiency of the control device and of the transmission

$$\eta H = \eta H_0 \times \eta H_1$$

- 2.2.17.  $s$ : travel of control (expressed in millimetres)
- 2.2.18.  $s'$ : effective travel of control (expressed in millimetres) fixed in accordance with the requirements of point 9.4.1
- 2.2.19.  $s''$ : spare travel of the master cylinder actuator, measured in millimetres at the coupling head
- 2.2.20.  $s_0$ : loss of travel, that is to say the travel, measured in millimetres, of the coupling head when it is actuated in such a way as to travel from a point 300 mm above the horizontal plane to a point 300 mm below, the transmission remaining stationary
- 2.2.21.  $2s_B$ : brake-shoe lift measured on the diameter parallel to the operating mechanism and without the brakes being adjusted during the test (expressed in millimetres)
- 2.2.22.  $2s_{B^*}$ : minimum brake shoe centre lift (minimum brake shoe application travel), in millimetres, for wheel brakes with drum brakes:

$$2s_{B^*} = 2,4 + \frac{4}{1000} \times 2r$$

$2r$  being the diameter of the brake drum expressed in millimetres (see diagram 4 in Appendix 1)

▼ M7

for wheel brakes with disc brakes with hydraulic transmission:

$$2s_{B^*} = 1,1 \frac{10 \times V_{60}}{F_{RZ}} + \frac{1}{1000} \times 2r_A$$

where:

$V_{60}$  = fluid volume absorption of one wheel brake at a pressure corresponding to a braking force of 1,2 1,2 B\* = 0,6 × G<sub>B0</sub> and a maximum tyre radius,

$2r_A$  = outer diameter of brake disc

( $V_{60}$  in cm<sup>3</sup>,  $F_{RZ}$  in cm<sup>2</sup> and  $r_A$  in mm)

- 2.2.23. M: braking moment
- 2.2.24. R: dynamic tyre rolling radius in metres, rounded to the nearest centimetre
- 2.2.25. n: number of brakes
- 2.2.26. D<sub>A</sub>: application force at input side of the control device, at which the overload protector is activated
- 2.2.27. M<sub>A</sub>: braking torque at which the overload protector is activated
- 2.3. *Symbols for mechanical transmission braking systems* (see diagram 5 in Appendix 1)
- 2.3.1. i<sub>H0</sub>: reduction ratio between travel of the coupling head and travel of the lever at the output side of the control device
- 2.3.2. i<sub>H1</sub>: reduction ratio between travel of the lever at the output side of the control device and travel of the brake lever (gearing down of transmission)
- 2.3.3. i<sub>H</sub>: reduction ratio between travel of the coupling head and travel of the brake lever
- $$i_H = i_{H_0} \times i_{H_1}$$
- 2.3.4. i<sub>g</sub>: reduction ratio between travel of the brake lever and the brake-shoe centre lift (see diagram 4 in Appendix 1)
- 2.3.5. P: force applied to the brake control lever
- 2.3.6. P<sub>0</sub>: brake retraction force; that is, in the graph  $M = f(P)$ , the value of the force P at the point of intersection of the extrapolation of this function with the abscissa (see diagram 6 in Appendix 1)
- 2.3.7. ρ: characteristic of the brake defined by:
- $$M = \rho (P - P_0)$$
- 2.4. *Symbols for hydraulic-transmission braking systems* (see diagram 8 in Appendix 1)
- 2.4.1. i<sub>h</sub>: reduction ratio between travel of the coupling head and travel of the piston in master cylinder
- 2.4.2. i<sub>g</sub>: reduction ratio between travel of the actuation point of the cylinders and the brake-shoe centre lift
- 2.4.3. F<sub>Rz</sub>: surface area of piston of one wheel cylinder for drum brake(s); for disc brake(s), sum of the surface area of the caliper piston(s) on one side of the disc
- 2.4.4. F<sub>Hr</sub>: surface area of piston in master cylinder
- 2.4.5. p: hydraulic pressure in brake cylinder
- 2.4.6. p<sub>0</sub>: retraction pressure in brake cylinder; that is, in the graph  $M = f(p)$ , the value of the pressure p at the point of intersection of the extrapolation of this function with the abscissa (see diagram 7 in Appendix 1)



## ▼M7

- 2.4.7.  $\rho'$ : characteristic of the brake defined by:

$$M = \rho' (p - p_0)$$

3. GENERAL REQUIREMENTS

- 3.1. The transmission of braking power from the coupling head to the trailer's brakes shall be effected either by a rod linkage or by means of one or more fluids. However, a sheathed cable (Bowden cable) may be used to provide part of the transmission. This part shall be as short as possible.
- 3.2. All pins at joints shall be adequately protected. In addition, these joints shall be either self-lubricating or easily accessible for lubrication.
- 3.3. Inertia braking systems shall be arranged in such a way that, in the case where the coupling head travels to its fullest extent, no part of the transmission becomes jammed, or suffers any permanent distortion or fails. This shall be checked after uncoupling the first element of the transmission from the brake control levers.
- 3.4. The inertia braking system shall allow the trailer to be reversed with the towing vehicle without imposing a sustained drag force exceeding  $0,08 \times g \times G_A$ . Devices used for this purpose shall act automatically and disengage automatically when the trailer moves forward.
- 3.5. Any special device incorporated for the purpose of point 3.4 shall be such that the parking performance when facing up a gradient shall not be adversely affected.
- 3.6. Only inertia braking systems with disc brakes may incorporate overload protectors. They may not be activated at a force of less than  $1,2 P$  or a pressure less than  $1,2 p$  corresponding to a braking force of  $B^* = 0,5 \times g \times G_{Bo}$  (when fitted at the wheel brake) or at a thrust on the coupling less than  $1,2 \times D^*$  (when fitted at the control device).

4. REQUIREMENTS FOR CONTROL DEVICES

- 4.1. The sliding members of the control device shall be long enough to enable the brake to be fully applied, even when the trailer is coupled.
- 4.2. The sliding members shall be protected by a bellows or some equivalent device. They shall either be lubricated or be constructed of self-lubricating materials. The surface in frictional contact shall be made of a material such that there is neither electrochemical torque nor any mechanical incompatibility liable to cause the sliding members to seize.
- 4.3. The threshold force of the control equipment ( $K_A$ ) shall be not less than  $0,02 \times g \times G'_A$ , and not more than  $0,04 \times g \times G'_A$ .
- 4.4. The maximum damping force  $D_1$  may not exceed  $0,10 \times g \times G'_A$  in the case of trailers with rigid drawbars and  $0,067 \times g \times G'_A$  in the case of multi-axled trailers with pivoted drawbars.
- 4.5. The maximum towing force  $D_2$  shall be between  $0,1 \times g \times G'_A$  and  $0,5 \times g \times G'_A$ .

5. TESTS AND MEASUREMENTS TO BE CARRIED OUT ON THE CONTROL SYSTEM

- 5.1. Compliance with the requirements of points 3 and 4 shall be verified on the control device submitted to the technical service conducting the tests.
- 5.2. The following shall be measured in respect of all types of braking systems:
- 5.2.1. The travel  $s$  and the effective travel  $s'$ .
- 5.2.2. The supplementary force  $K$ .
- 5.2.3. The threshold force  $K_A$ .
- 5.2.4. The damping force  $D_1$ .

▼ M7

- 5.2.5. The towing force  $D_2$ .
- 5.3. In the case of mechanical-transmission inertia braking systems, the following shall be determined:
- 5.3.1. The reduction ratio  $i_{H_0}$  measured at the mid-travel position of the control.
- 5.3.2. The force  $P'$  at the output side of the control device as a function of the thrust  $D$  on the drawbar. The supplementary force  $K$  and the efficiency shall be derived from the representative curve obtained from these measurements.

$$\eta_{H_0} = \frac{1}{i_{H_0}} \times \frac{P'}{D - K}$$

(see diagram 2 in Appendix 1).

- 5.4. In the case of hydraulic-transmission inertia braking systems, the following shall be determined:
- 5.4.1. The reduction ratio  $i_h$  measured at the mid-travel position of the control.
- 5.4.2. The pressure  $p$  at the output side of the master cylinder as a function of the thrust  $D$  on the drawbar and of the surface area  $F_{HZ}$  of the master cylinder piston, as specified by the manufacturer. The supplementary force  $K$  and the efficiency shall be derived from the representative curve obtained from these measurements

$$\eta_{H_0} = \frac{1}{i_h} \times \frac{p \times F_{HZ}}{D - K}$$

(see diagram 3 in Appendix 1).

- 5.4.3. The spare travel of the master cylinder actuator  $s''$  mentioned in point 2.2.19.
- 5.5. In the case of inertia braking systems on multi-axled trailers with pivoted drawbars, the loss of travel  $s_0$  mentioned in point 9.4.1 shall be measured.

## 6. REQUIREMENTS FOR BRAKES

- 6.1. The manufacturer shall make available to the technical service responsible for the tests, in addition to the brakes to be tested, drawings of the brakes showing the type, dimensions and material of the main parts, and the make and type of the linings. These drawings shall indicate the surface area  $F_{RZ}$  of the brake cylinders in the case of hydraulic brakes. The manufacturer shall also indicate the maximum braking torque  $M_{max}$  which is allowed, as well as the mass  $G_{BO}$  mentioned in point 2.2.4.
- 6.2. The braking torque  $M_{max}$  specified by the manufacturer shall be not less than that braking torque corresponding to 1,2 times the force  $P$  or 1,2 times the pressure  $p$ , required to give a braking force of  $B^* = 0,5 \times g \times G_{BO}$ .
- 6.2.1. In the case when no overload protector is either fitted or intended to be fitted within the inertia (overrun) braking system, the wheel brake shall be tested at 1,8 times the force  $P$  or at 1,8 times the pressure  $p$ , which is required to give a braking force of  $B^* = 0,5 \times g \times G_{BO}$ .
- 6.2.2. In the case when an overload protector is fitted or intended to be fitted within the inertia (overrun) braking system, the wheel brake shall be tested at 1,1 times the force  $P_{max}$  or  $P'_{max}$  or at 1,1 times the pressure  $p_{max}$  or  $p'_{max}$  of the overload protector including all tolerances (specified by the manufacturer).
7. TESTS AND MEASUREMENTS TO BE CARRIED OUT ON THE BRAKES
- 7.1. The brakes and items of equipment made available to the technical service responsible for the tests shall be tested to check whether they conform to the requirements of point 6.
- 7.2. The following shall be determined:

▼ M7

- 7.2.1. The minimum shoe centre lift  $2s_B^*$ .
- 7.2.2. The shoe centre lift  $2s_B$  (which shall be greater than  $2s_B^*$ ).
- 7.2.3. The braking moment  $M$  as a function of the force  $P$  applied to the control lever in the case of devices with mechanical transmission, and of the pressure  $p$  in the brake cylinder in the case of devices with hydraulic transmission.
- The speed at which the braking surfaces rotate shall correspond to an initial vehicle speed of 60 km/h. The following is deduced from the curve obtained from these measurements:
- 7.2.3.1. The retraction force  $P_O$  and the characteristic  $\rho$  in the case of mechanically actuated brakes (see diagram 6 in Appendix 1).
- 7.2.3.2. The retraction pressure  $p_o$  and the characteristic  $\rho'$  in the case of hydraulically actuated brakes (see diagram 7 in Appendix 1).
8. TEST REPORTS
- Where applications are made for type-approval of trailers fitted with inertia braking systems, such applications are to be accompanied by the test reports relating to the control system and the brakes, as well as the test report on the compatibility between the inertia control device, the transmission and the brakes on the trailer; these reports are to include at least the particulars shown in Appendices 2, 3 and 4 to this Annex.
9. COMPATIBILITY OF THE CONTROL DEVICE AND THE BRAKES OF A VEHICLE
- 9.1. A check shall be made on the vehicle, taking into account the characteristics of the control device (Appendix 2) and of the brakes (Appendix 3) as well as the trailer characteristics mentioned in point 4 of Appendix 4, as to whether the inertia braking system of the trailer complies with the requirements laid down.
- 9.2. *General tests for all types of brakes*
- 9.2.1. Those parts of the transmission which have not been tested at the same time as the brake control device or the brakes shall be tested on the vehicle. The results of the test shall be entered in Appendix 4 (for example  $i_{H1}$  and  $\eta_{H1}$ ).
- 9.2.2. **Mass**
- 9.2.2.1. The maximum mass of the trailer  $G_A$  shall not exceed the maximum mass  $G'_A$  for which the control device is authorised.
- 9.2.2.2. The maximum mass of the trailer  $G_A$  shall not exceed the maximum mass  $G_B$  which can be braked by the joint operation of all the trailer brakes.
- 9.2.3. **Forces**
- 9.2.3.1. The threshold force  $K_A$  shall not be less than  $0,02 \times g \times G_A$  nor greater than  $0,04 \times g \times G_A$ .
- 9.2.3.2. The maximum damping force  $D_1$  shall not exceed  $0,10 \times g \times G_A$  in the case of trailers with rigid drawbars, nor  $0,067 \times g \times G_A$  in the case of multi-axled trailers with pivoted drawbars.
- 9.2.3.3. The maximum towing force  $D_2$  shall be between  $0,1 \times g \times G_A$  and  $0,5 \times g \times G_A$ .
- 9.3. *Test of braking efficiency*
- 9.3.1. The sum of the braking forces exerted on the circumference of the trailer wheels shall be at least  $B^* = 0,5 \times g \times G_A$  including a rolling resistance of  $0,01 \times g \times G_A$ . This represents a braking force of  $B = 0,49 \times g \times G_A$ . In this case, the maximum permitted thrust on the coupling is:
- $D^* = 0,067 \times g \times G_A$  in the case of multi-axled trailers with pivoting drawbars, and
- $D^* = 0,10 \times g \times G_A$  in the case of trailers with rigid drawbars.

▼ M7

In order to check whether these conditions are observed, the following inequalities shall be applied:

- 9.3.1.1. In the case of inertia braking systems with mechanical transmission

$$\left[ \frac{B \times R}{\rho} + nP_o \right] \frac{1}{(D * -K) \times \eta_H} \leq i_H$$

- 9.3.1.2. In the case of inertia braking systems with hydraulic transmission

$$\left[ \frac{B \times R}{n \times \rho'} + P_o \right] \frac{1}{(D * -K) \times \eta_H} \leq \frac{i_h}{F_{HZ}}$$

9.4. *Control travel test*

- 9.4.1. In the case of control devices for multi-axle trailers with pivoted drawbars, of which the brake rod system is dependent upon the position of the towing device, the travel of the control  $s$  shall be greater than the effective travel of the control  $s'$ ; the difference in length shall be at least equivalent to the loss of travel  $s_o$ . The travel  $s_o$  shall not exceed 10 % of the effective travel  $s'$ .

- 9.4.2. The effective travel of the control  $s'$  shall be determined in the following way:

- 9.4.2.1. If the brake rod system is affected by the relative position of the towing device, then

$$s' = s - s_o$$

- 9.4.2.2. If there is no loss of travel, then

$$s' = s$$

- 9.4.2.3. In the case of hydraulic braking systems

$$s' = s - s''$$

- 9.4.3. The following inequalities shall be applied in order to check whether the travel of the control is adequate:

- 9.4.3.1. In the case of inertia braking systems with mechanical transmission:

$$i_H \leq \frac{s'}{S_{B*} \times i_g}$$

- 9.4.3.2. In the case of inertia braking systems with hydraulic transmission:

$$\frac{i_h}{F_{HZ}} \leq \frac{s'}{2S_{B*} \times nF_{RZ} \times i_g'}$$

9.5. *Additional tests*

- 9.5.1. In the case of inertia braking systems with mechanical transmission, a check shall be made as to whether the rod system by which the forces are transmitted from the control device is correctly fitted.

- 9.5.2. In the case of inertia braking systems with hydraulic transmission, a check shall be made as to whether the travel of the master cylinder actuator reaches a minimum level of  $s/i_h$ .

A lower level shall not be permitted.

- 9.5.3. The general behaviour of the vehicle when braking shall be the subject of a road test carried out at different speeds, with different levels of brake effort and rates of application; self-excited undamped oscillations shall not be permitted.

10. GENERAL COMMENTS

The above provisions apply to the latest models of inertia braking systems with mechanical or hydraulic transmission; in the case of these models, in particular, all the wheels of the trailer are fitted with the same type of brake and the same type of tyre.

▼ M7

When testing special models, the above requirements shall be adapted.

▼ M7

*Appendix 1*

**Explanatory diagrams**

*Diagram 1*

**Symbols valid for all types of braking systems**

(see point 2.2)

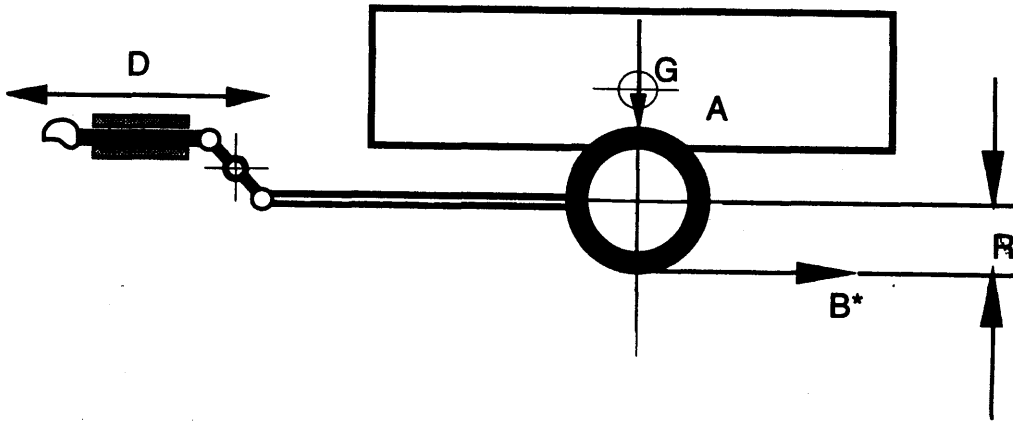

*Diagram 2*

**Mechanical transmission**

(see points 2.2.10 and 5.3.2)

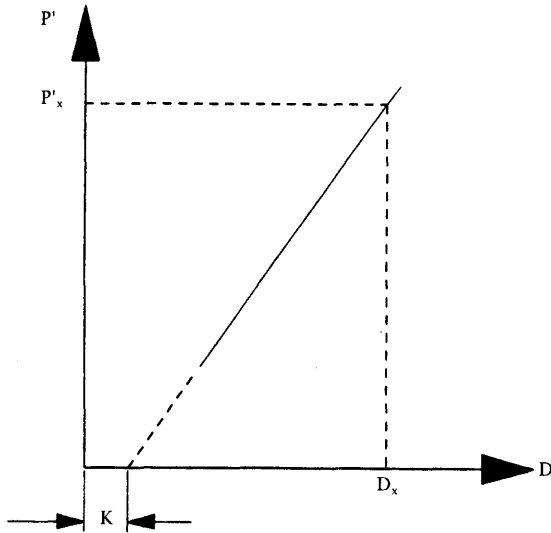

$$\eta_{H0} = \frac{P'_x}{D_x - K} \times \frac{1}{i_{H0}}$$

▼ M7

Diagram 3

**Hydraulic transmission**

(see points 2.2.10 and 5.4.2)

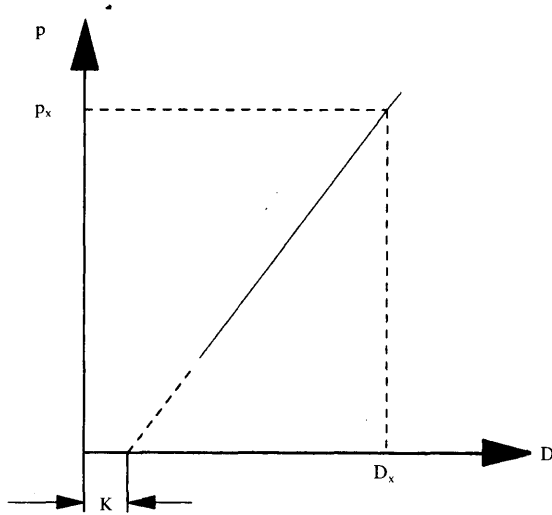

$$\eta_{H0} = \frac{P_x}{D_x - K} \times \frac{F_{HZ}}{i_h}$$

Diagram 4

**Brake checks**

(see points 2.2.22 and 2.3.4)

**Connecting rod and cam**

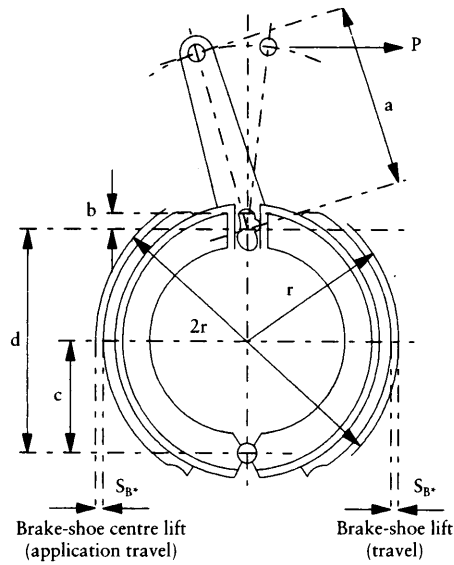

$$i_a = \frac{a}{2b}$$

$$i_g = \frac{a \times d}{b \times c}$$

▼ M7

Brake-shoe centre lift:  $S_B^* = 1,2 \text{ mm} + 0,2 \% \times 2r$

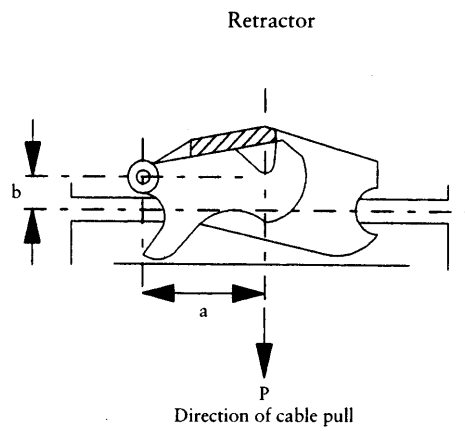

Retractor:

$$i_a = \frac{a}{b}$$

$$i_g = \frac{a \times d}{b \times c}$$

Diagram 5

**Brakes with mechanical transmission**

(see point 2.3)

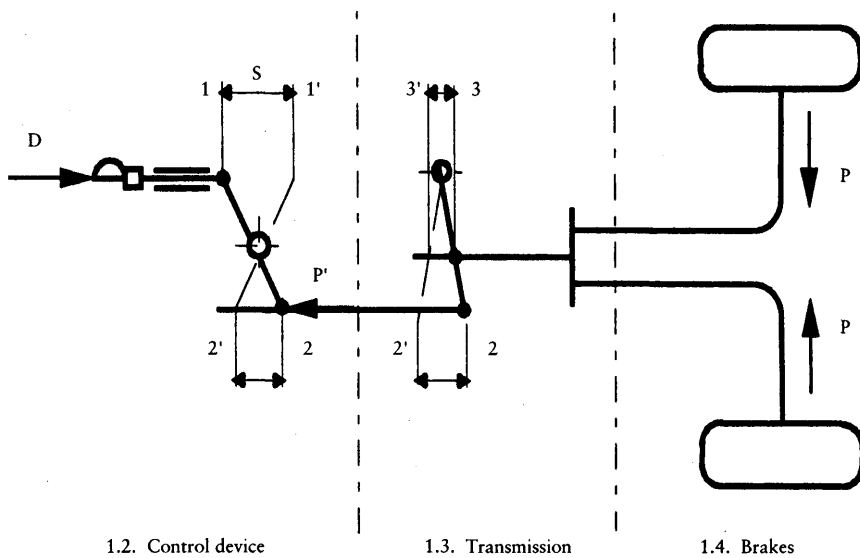

$$i_{H0} = \frac{1-1'}{2-2'}$$

$$i_{H1} = \frac{2-2'}{3-3'}$$



▼ M7

Diagram 6

**Mechanical brake**

(see points 2.3.6 and 7.2.3.1)

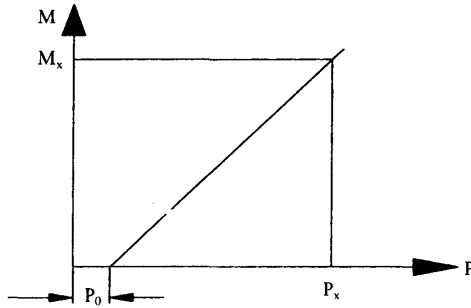

$$e = \frac{M_x}{P_x - P_0}$$

Diagram 7

**Hydraulic brake**

(see points 2.4.6 and 7.2.3.2)

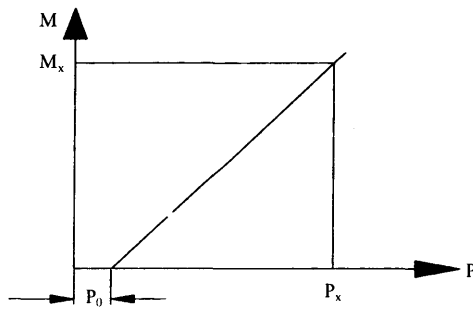

$$e' = \frac{M_x}{P_x - P_0}$$

▼M7

Diagram 8  
Hydraulic transmission braking system

(see point 2.4)

1.2. Control device

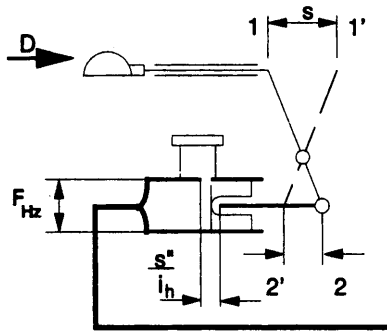

$$i_h = \frac{1 - 1'}{2 - 2'}$$

1.4. Brakes

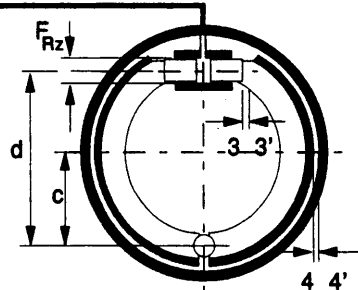

drum brake

$$i_g = \frac{d}{c} = \frac{3 - 3'}{4 - 4'}$$

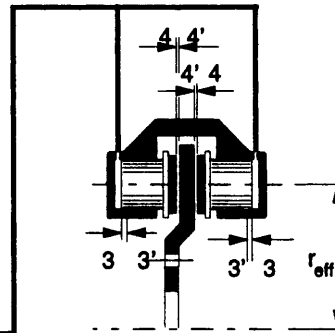

disc brake

$$i_b = \frac{r_{eff}}{r_{eff}} = \frac{3 - 3'}{4 - 4'} = 1$$

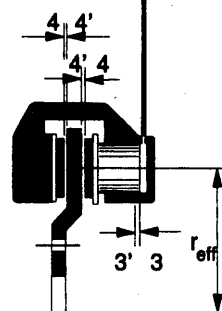

disc brake

$$i_b = \frac{r_{eff}}{r_{eff}} = \frac{3 - 3'}{2 \cdot (4 - 4')} = 1$$

▼ **M7**

## Appendix 2

## Test report on the control device

1. Manufacturer .....
2. Make .....
3. Type .....
4. Characteristics of the trailers for which the control device is intended by the manufacturer:
  - 4.1. mass  $G'_A = \dots\dots\dots$  kg
  - 4.2. permissible vertical static force at the head of the towing device .....
  - 4.3. trailer with rigid drawbar <sup>(1)</sup> or multi-axled trailer with pivoted drawbar <sup>(1)</sup>
5. Brief description  
(List of attached plans and dimensional drawings)
6. Main diagram of the control device
7. Travel  $s = \dots\dots\dots$  mm
8. Reduction ratio of the control device:
  - 8.1. in the case of a device with mechanical transmission <sup>(1)</sup>  
 $i_{H_0} = \text{from } \dots\dots\dots \text{ to } \dots\dots\dots$  <sup>(2)</sup>
  - 8.2. in the case of a device with hydraulic transmission <sup>(1)</sup>  
 $i_h = \text{from } \dots\dots\dots \text{ to } \dots\dots\dots$  <sup>(2)</sup>  
 $F_{HZ} = \dots\dots\dots$   $\text{cm}^2$   
travel of the master cylinder actuator .....
9. Test results:
  - 9.1. Efficiency
    - in the case of a device with mechanical transmission  $\eta_H = \dots\dots\dots$
    - in the case of a device with hydraulic transmission  $\eta_H = \dots\dots\dots$
  - 9.2. complementary force  $K = \dots\dots\dots$  N
  - 9.3. Maximum damping force  $D_1 = \dots\dots\dots$  N
  - 9.4. Maximum towing force  $D_2 = \dots\dots\dots$  N
  - 9.5. Threshold force  $K_A = \dots\dots\dots$  N
  - 9.6. Loss of travel and spare travel:
    - where the position of the towing device has an effect  $s_0$  <sup>(1)</sup> = .....
    - in the case of a device with hydraulic transmission  $s''$  <sup>(1)</sup> = .....
  - 9.7. Effective travel of the control  $s' = \dots\dots\dots$
  - 9.8. An overload protector according to point 3.6 of this Annex is provided/not provided <sup>(1)</sup>
    - 9.8.1. If the overload protector is fitted before the transmission lever of the control device
      - 9.8.1.1. Threshold force of the overload protector  
 $D_A = \dots\dots\dots$  N
      - 9.8.1.2. where the overload protector is mechanical <sup>(1)</sup>  
maximum force  $P'_{\max}$  which the inertia control device can develop  
 $P'_{\max}/i_{H_0} = \dots\dots\dots$  N

<sup>(1)</sup> Delete as appropriate.<sup>(2)</sup> Indicate the lengths whose ratio was used to determine  $i_{H_0}$  or  $i_h$ .

**▼M7**

- 9.8.1.3. where the overload protector is hydraulic <sup>(1)</sup>  
maximum hydraulic pressure which the inertia control device can develop  
 $P'_{\max}/i_H = \dots\dots\dots \text{ N/cm}^2$
- 9.8.2. If the overload protector is fitted after the transmission lever of the control device
- 9.8.2.1. Threshold force of the overload protector  
where the overload protector is mechanical <sup>(1)</sup>  $D_A i_{H_0} = \dots\dots\dots \text{ N}$ ,  
where the overload protector is hydraulic <sup>(1)</sup>  $D_A i_h = \dots\dots\dots$
- 9.8.2.2. Where the overload protector is mechanical <sup>(1)</sup>  
maximum force  $P'_{\max}$  which the inertia control device can develop  
 $P'_{\max} = \dots\dots\dots \text{ N}$
- 9.8.2.3. Where the overload protector is hydraulic <sup>(1)</sup>  
maximum hydraulic pressure which the inertia control device can develop  
 $P'_{\max} = \dots\dots\dots \text{ N/cm}^2$
10. Technical service which carried out the tests
11. The control device described above does/does not <sup>(1)</sup> comply with the requirements of points 3, 4 and 5 of the testing conditions for vehicles fitted with inertia braking systems.

.....  
Signature

<sup>(1)</sup> Delete as appropriate

▼ **M7**

*Appendix 3*  
**Test report on the brake**

1. Manufacturer .....
2. Make .....
3. Type .....
4. Technically permissible maximum mass per wheel  $G_{Bo} = \dots\dots\dots$  kg
5. Maximum braking torque  $M_{max} = \dots\dots\dots$  Nm  
(as specified by the manufacturer according to point 6.2 of this Annex)
- 5.1. Tested braking torque =  $\dots\dots\dots$  Nm  
(according to points 6.2.1 and 6.2.2 respectively of this Annex)
6. Dynamic tyre rolling radius  
 $R_{min} = \dots\dots\dots$  m;  $R_{max} = \dots\dots\dots$  m
7. Brief description  
(List of plans and dimensional drawings)
8. Main diagram of the brake:
9. Test result:
- | Mechanical brake <sup>(1)</sup>   | Hydraulic brake <sup>(1)</sup>   |
|---|--|
| 9.1. Reduction ration<br>$i_g = \dots\dots\dots$ <sup>(2)</sup>                                   | 9.1a. Reduction ration<br>$i'_g = \dots\dots\dots$ <sup>(2)</sup>                                  |
| 9.2. Half shoe centre lift<br>$s_B = \dots\dots\dots$ mm  | 9.2a. Half shoe centre lift<br>$s_B = \dots\dots\dots$ mm  |
| 9.3. Half minimum shoe centre lift<br>$s_B = \dots\dots\dots$ mm                                  | 9.3a. Half minimum shoe centre lift<br>$s_B = \dots\dots\dots$ mm                                  |
| 9.4. Withdrawal force<br>$P_0 = \dots\dots\dots$ N  | 9.4a. Withdrawal pressure<br>$p_0 = \dots\dots\dots$ bar   |
| 9.5. Coefficient<br>$Q = \dots\dots\dots$ m   | 9.4a. Coefficient<br>$Q' = \dots\dots\dots$ m cm <sup>2</sup>                                      |
| 9.6. An overload protector according to point 3.6 of this Annex is/is not provided <sup>(1)</sup> | 9.6a. An overload protector according to point 3.6 of this Annex is/is not provided <sup>(1)</sup> |
| 9.6.1. Braking torque activating the overload protector<br>$M_A = \dots\dots\dots$ Nm             | 9.6.1a. Braking torque activating the overload protector<br>$M_A = \dots\dots\dots$ Nm             |
| 9.7. Maximum permissible force for $M_{max}$<br>$P_{max} = \dots\dots\dots$ N                     | 9.7a. Maximum permissible pressure for $M_{max}$<br>$p_{max} = \dots\dots\dots$ N/cm <sup>2</sup>  |
|   | 9.8a. Surface area of wheel cylinder<br>$F_{RZ} = \dots\dots\dots$ cm <sup>2</sup>                 |
|   | 9.9a. (for disc brakes)<br>Fluid volume absorption<br>$V_{60} = \dots\dots\dots$ cm <sup>2</sup>   |
10. Technical Service which carried out the test
11. The above brake does/does not <sup>(1)</sup> conform to the requirements of points 3 and 6 of the testing conditions for vehicles fitted with inertia braking systems described in this Annex.  
The brake may/may not <sup>(1)</sup> be used for an inertia braking system without an overload

.....  
Signature

<sup>(1)</sup> Delete as appropriate.

<sup>(2)</sup> Indicate the lengths which have been used to determine  $i_g$  or  $i'_g$

▼ **M7***Appendix 4***Test report on the compatibility of the control device, the transmission and the brakes**

1. *Control device*  
described in the attached test report (see Appendix 2)  
  
Reduction ratio selected:  
 $i_{H0}^{(1)} = \dots\dots\dots^{(2)}$  or  $i_h^{(1)} = \dots\dots\dots^{(2)}$   
(shall be between the limits specified in Appendix 2, point 8.1 or 8.2)
  
2. *Brakes*  
described in the attached test report (see Appendix 3)
  
3. *Transmission devices on the trailer*
  - 3.1. Brief description with main diagram
  - 3.2. Reduction ratio and efficiency of the mechanical transmission device on the trailer  
 $i_{HI}^{(2)} = \dots\dots\dots$   
 $\eta_{HI} = \dots\dots\dots$
  
4. *Trailer*
  - 4.1. Manufacturer:
  - 4.2. Make:
  - 4.3. Type:
  - 4.4. Type of drawbar connection:  
single-axled trailer with rigid drawbar/multi-axled trailer with pivoted drawbar <sup>(1)</sup>
  - 4.5. Number of brakes  $n = \dots\dots\dots$
  - 4.6. Technically permissible maximum mass  $G_A = \dots\dots\dots$  kg
  - 4.7. Dynamic tyre rolling radius  $R = \dots\dots\dots$  m
  - 4.8. Permissible force on the coupling  $D^* = 0,10 \times g \times G_A = \dots\dots\dots$  N  
or  
 $D^* = 0,067 \times g \times G_A = \dots\dots\dots$  N  
Required braking force  $B^* = 0,5 \times g \times G_A = \dots\dots\dots$  N  
Braking force  $B = 0,49 \times g \times G_A = \dots\dots\dots$  N
  
5. *Compatibility Test results*
  - 5.1. Stress threshold  $100 K_A/g \times G_A \dots\dots\dots$   
(shall be between 2 and 4)
  - 5.2. Maximum compressive force  $100 D_1/(g \times G_A) \dots\dots\dots$   
(shall not exceed 10 for trailers with rigid drawbar, or, 6,7 for multi-axled trailers with pivoted drawbar)
  - 5.3. Maximum tractive force  $100 D_2/(g \times G_A) \dots\dots\dots$   
(shall be between 10 and 50)
  - 5.4. Technically permissible maximum mass for the inertia control device  $G_A' \dots\dots\dots$  kg  
(shall not be less than  $G_A$ )

<sup>(1)</sup> Delete as applicable.<sup>(2)</sup> Indicate the lengths which have been used to determine  $i_{h0}$ ,  $i_h$  or  $i_{HI}$ .

## ▼M7

- 5.5. Technically permissible maximum mass for all trailer brakes.  
 $G_B = n \times G_{Bo} = \dots\dots\dots$  kg  
 (shall not be less than  $G_A$ )
- 5.6. Maximum braking torque of the brakes  
 $n \times M_{max}/(B \times R) = \dots\dots\dots$   
 (shall be equal to or greater than 1,2)
- 5.6.1. An overload protector within the meaning of point 3.6 of this Annex is/is not <sup>(1)</sup> fitted on the inertia control device/on the brakes <sup>(1)</sup>
- 5.6.1.1. Where the overload protector is mechanical on the inertia control device <sup>(1)</sup>  
 $n \times P_{max}/(i_{HI} \times \eta_{HI} \times P'_{max}) = \dots\dots\dots$   
 (shall be equal or greater than 1,0)
- 5.6.1.2. where the overload protector is hydraulic on the inertia control device <sup>(1)</sup>  
 $P_{max}/P'_{max} = \dots\dots\dots$   
 (shall be equal or greater than 1,0)
- 5.6.1.3. if the overload protector is on the inertia control device:  
 threshold force  $D_A/D^* = \dots\dots\dots$   
 (shall be equal or greater than 1,2)
- 5.6.1.4. if the overload protector is fitted on the brake:  
 threshold torque  $n M_A/(B \times R) = \dots\dots\dots$   
 (shall be equal or greater than 1,2)
- 5.7. Inertia braking system with mechanical transmission <sup>(1)</sup>
- 5.7.1.  $i_H = i_{Ho} \times i_{HI} = \dots\dots\dots$
- 5.7.2.  $\eta_H = \eta_{Ho} \times \eta_{HI} = \dots\dots\dots$
- 5.7.3.  $\left[ \frac{B \times R}{Q} + n \times P_o \right] \frac{1}{(D^* - K) \times \eta_H} = \dots\dots\dots$   
 (shall not be greater than  $i_H$ ).
- 5.7.4.  $\frac{s'}{S_{B^*} \times i_g} = \dots\dots\dots$
- 5.8. Inertia braking system with hydraulic transmission <sup>(1)</sup>
- 5.8.1.  $i_h/F_{HZ} = \dots\dots\dots$
- 5.8.2.  $\left[ \frac{B \times R}{n \times Q'} + P_o \right] \frac{1}{(D^* - K) \times \eta_H} = \dots\dots\dots$   
 (shall be not greater than  $i_h/F_{HZ}$ )
- 5.8.3.  $\frac{s'}{2s_{B^*} \times n \times F_{RZ} \times i_g'} = \dots\dots\dots$   
 (shall be not less than  $i_h/F_{HZ}$ )
- 5.8.4.  $s/i_h = \dots\dots\dots$   
 (shall be not greater than the travel of the master cylinder actuator as specified in point of Appendix 2)
6. *Technical Service which carried out the tests*
7. The inertia braking system described above does/does not<sup>(1)</sup> comply with the requirements of points 3 to 9 of the testing conditions for vehicles fitted with inertia braking systems.

.....  
 Signature

<sup>(1)</sup> Delete as appropriate.

▼ **M7***ANNEX IX***Type-approval documentation***Appendix I*

## MODEL

(maximum format: A4 (210 × 297 mm))

**EC TYPE-APPROVAL CERTIFICATE**

Stamp of administration

►<sup>(0)</sup>Communication (\*) concerning the ◀

- type approval <sup>(1)</sup>
- extension of type approval <sup>(1)</sup>
- refusal of type approval <sup>(1)</sup>
- withdrawal of type approval <sup>(1)</sup>

of a type of a vehicle/component/separate technical unit <sup>(1)</sup> with regard to Directive 71/320/EC, as last amended by Directive 98/12/EF.

Type-approval number: .....

Reason for extension: .....

## SECTION I

- 0.1. Make (trade name of manufacturer):
- 0.2. Type:
- 0.3. Means of identification of type if marked on the vehicle/component/separate technical unit <sup>(1)</sup> <sup>(2)</sup>:
- 0.3.1. Location of that marking:
- 0.4. Category of vehicle <sup>(1)</sup> <sup>(3)</sup>:
- 0.5. Name and address of manufacturer:
- 0.7. In the case of components and separate technical units, location and method of affixing of the EC approval mark:
- 0.8. Address(es) of assembly plant(s):

## SECTION II

1. Additional information (where applicable): See Addendum
2. Technical service responsible for carrying out the tests:
3. Date of test report:
4. Number of test report:
5. Remarks (if any): See Addendum
6. Place:
7. Date:
8. Signature:
9. The index to the information package lodged with the approval authority, which may be obtained on request, is attached.

(\*) At the request of (an) applicant(s) for an approval to Annex XV of Directive 71/320/EEC, the information referred to in Annex IX, Appendix 3, of Directive 71/320/EEC shall be provided by the Type Approval Authority. However, this information shall not be provided for purposes other than approvals to Annex XV of Directive 71/320/EEC.

<sup>(1)</sup> Delete where not applicable.

<sup>(2)</sup> If the means of identification of type contains characters not relevant to describe the vehicle, component or separate technical unit types covered by this type-approval certificate such characters shall be represented in the documentation by the symbol '?' (e. g. ABC?123?).

<sup>(3)</sup> As defined in Annex II (A) to Directive 70/156/EEC.



▼ **M7***Addendum*

to EC type-approval certificate No ... concerning the type-approval of a vehicle with regard to Directive 71/320/EEC as last amended by Directive 98/12/EC

1. ADDITIONAL INFORMATION
- 1.1. *Mass of vehicle*
  - 1.1.1. Maximum mass of vehicle: .....
  - 1.1.2. Minimum mass of vehicle: .....
  - 1.1.3. Distribution of the mass on each axle (maximum value): .....
- ▶<sup>(1)</sup> 1.2. *Brake linings:*
  - 1.2.1 Brake linings tested to all relevant prescriptions of Annex II: .....
  - 1.2.1.1 Make(s) and type(s) of brake linings: .....
  - 1.2.2 Alternative brake linings tested in Annex XII: .....
  - 1.2.2.1 Make(s) and type(s) of brake linings: .....
- 1.3. *In the case of a motor vehicle:*
  - 1.3.1. Engine type: .....
  - 1.3.2. If applicable <sup>(1)</sup>, maximum mass of trailer which may be coupled: .....
  - 1.3.2.1. full trailer: .....
  - 1.3.2.2. semi-trailer: .....
  - 1.3.2.3. centre-axle trailer: indicate also the maximum ratio of the coupling overhang <sup>(2)</sup> to the wheelbase: .....
  - 1.3.2.4. maximum mass of the combination: .....
  - 1.3.2.5. O<sub>1</sub> trailer: braked/unbraked <sup>(1)</sup> .....
  - 1.3.2.6. vehicle is/is not <sup>(1)</sup> equipped to tow trailers with electrical braking system .....
  - 1.3.2.7. vehicle is/is not <sup>(1)</sup> equipped to tow trailers with anti-lock braking systems .....
- 1.4. *Tyre dimensions:*
  - 1.4.1. Temporary-use spare wheel/tyre dimensions: .....
  - 1.4.2. Vehicle meets the requirements of Annex XIII: yes/no <sup>(1)</sup> .....
- 1.5. *Number and arrangement of axles:* .....
- 1.6. *Brief description of the braking equipment:* .....

<sup>(1)</sup> Delete as appropriate.

<sup>(2)</sup> 'Coupling overhang' is the horizontal difference between the coupling for centre-axle trailers and the centre-line of the rear axle(s).

**▼M7**

- 1.7. *Distribution of braking among the axles of a vehicle:* .....
- 1.7.1. Does the vehicle fulfil the requirements contained in the Appendix to Annex II: yes/no <sup>(1)</sup>
- 1.7.2. Information required in point 7.3 of the Appendix to Annex II: .....
- 1.8. *Vehicles equipped with anti-lock braking systems*
- 1.8.1. Motor vehicles
- 1.8.1.1. Does the vehicle fulfil the requirements contained in Annex X: yes/no <sup>(1)</sup>
- 1.8.1.2. Category of anti-lock braking system: Category 1/2/3 <sup>(1)</sup>
- 1.8.2. Trailers
- 1.8.2.1. Does the vehicle fulfil the requirements contained in Annex X: yes/no <sup>(1)</sup>
- 1.8.2.2. Category of anti-lock braking system: Category A/B <sup>(1)</sup>
- 1.8.2.3. Where an Annex XIV test report has been utilised, the test report number shall be stated: .....
- 1.9. *Trailers with electrical braking systems*
- 1.9.1. Does the vehicle fulfil the requirements in Annex XI: yes/no <sup>(1)</sup> .....
5. *Remarks:* .....

---

<sup>(1)</sup> Delete as appropriate.

▼ **M7***Appendix 2***Test report**

- 1.
- Mass of vehicle at the time of testing on the following:*

	unladen (kg)	laden (kg)
King pin supporting load <sup>(1)</sup>		
Axle No 1 <sup>(2)</sup>		
Axle No 2		
Axle No 3		
Axle No 4		
Total		

- 2.
- Result of the tests:*

Test	Test speed km/h	Measured performance	Measured force applied to the control (N)
2.1. Type 0 tests, engine disconnected service braking secondary braking			
2.2. Type 0 test engine connected service braking in accordance with Annex II, point 2.1.1.1.1 <sup>(2)</sup>			
2.3. Type I tests with repeated braking <sup>(3)</sup> with continuous braking <sup>(4)</sup>			
2.4. Type II or Type IIA tests, as appropriate			
2.4.1. Type III test <sup>(4)</sup>			

<sup>(1)</sup> In the case of a semi-trailer or a centre-axle trailer, enter the mass corresponding to the load on the coupling device.<sup>(2)</sup> Delete as appropriate.<sup>(3)</sup> Applies only to motor vehicles.<sup>(4)</sup> Applies only to trailers.

## ▼M7

- 2.5. Braking system(s) used during the Type II/IIA or Type III <sup>(1)</sup> test:
- 2.6. Reaction time and dimensions of flexible pipes
- 2.6.1. Reaction time at the brake actuator ..... sec.
- 2.6.2. Reaction time at the control line coupling head ..... sec.
- 2.6.3. Flexible pipes of tractive units for semi-trailers:  
— length: ... m  
— internal diameter ... mm
- 2.7. Cases in which Type I and/or II (or IIA) or Type III tests do not have to be carried out (Annex VII):
- 2.7.1. Type-approval number of the reference vehicle
- 2.7.2.

	Vehicle axles			Reference axles		
	Mass per axle (*)	Required braking force to the wheels	Speed	Mass per axle (*)	Actual braking force developed at the wheels	Speed
	kg	N	km/h	kg	N	km/h
Axle 1						
Axle 2						
Axle 3						
Axle 4						

(\*) This is the technically permissible maximum mass per axle.

- 2.7.3.

Maximum mass of the vehicle submitted for type-approval	... kg
Required braking force to the wheels	... N
Required retarding torque on the main shaft of the brake	... Nm
Retarding torque obtained on the main shaft of the brake (according to diagram)	... Nm

## ▼M7

## 2.7.4.

Reference axle ...	Report No ...	Date ... (copy attached)	
	Type I	Type III	
Brake forces per axle (N) (see point 4.2, Appendix 1 of Annex VII)			
Axle 1	$T_1 = \dots\dots\dots \% P_e$	$T_1 = \dots\dots\dots \% P_e$	
Axle 2	$T_2 = \dots\dots\dots \% P_e$	$T_2 = \dots\dots\dots \% P_e$	
Axle 3	$T_3 = \dots\dots\dots \% P_e$	$T_3 = \dots\dots\dots \% P_e$	
Predicted actuator stroke (mm) (see point 4.3.1.1, Appendix 1 of Annex VII)			
Axle 1	$S_1 = \dots\dots\dots$	$S_1 = \dots\dots\dots$	
Axle 2	$S_2 = \dots\dots\dots$	$S_2 = \dots\dots\dots$	
Axle 3	$S_3 = \dots\dots\dots$	$S_3 = \dots\dots\dots$	
Average output thrust (N) (see point 4.3.1.2, Appendix 1 of Annex VII)			
Axle 1	$Th_{A1} = \dots\dots\dots$	$Th_{A1} = \dots\dots\dots$	
Axle 2	$Th_{A2} = \dots\dots\dots$	$Th_{A2} = \dots\dots\dots$	
Axle 3	$Th_{A3} = \dots\dots\dots$	$Th_{A3} = \dots\dots\dots$	
Braking performance (N) (see point 4.3.1.4, Appendix 1 of Annex VII)			
Axle 1	$T_1 = \dots\dots\dots$	$T_1 = \dots\dots\dots$	
Axle 2	$T_2 = \dots\dots\dots$	$T_2 = \dots\dots\dots$	
Axle 3	$T_3 = \dots\dots\dots$	$T_3 = \dots\dots\dots$	
	Type 0 subject trailer test result (E)	Type I (predicted) hot	Type III (predicted) hot
Braking performance of vehicle (see point 4.3.2, Appendix 1 of Annex VII)			
Hot braking requirements (see point 1.3.3 and 1.6.2 of Annex II)	$\geq 0,36$ and $\geq 0,6 E$	$\geq 0,40$ and $\geq 0,6 E$	

3. *Reservoirs and energy sources using compressed-air:*
- 3.1. Total volume of the brake reservoirs .....
- 3.2. Value  $p_2$  declared by manufacturer .....
- 3.3. Pressure in the reservoir after a test of eight brake applications .....

**▼M7**

- 3.4. Charging time  $T_1$  .....
- 3.5. Charging time  $T_2$  .....
- 3.6. Total volume of the reservoirs of auxiliary systems .....
- 3.7. Charging time  $T_3$  .....
  
- 4. *Automatic braking on trailers with compressed-air braking system*
- 4.1. Braking rate achieved .....
  
- 5. *Trailers with electrical braking system*
- 5.1. Braking rate achieved .....

▼ M7*Appendix 3***List of vehicle data for the purpose of approvals pursuant to Annex XV**

1. Description of the vehicle type
  - 1.1. Trade name or mark of the vehicle, if available:
  - 1.2. Vehicle category:
  - 1.3. Vehicle type according to Annex IX, Appendix 1:
  - 1.4. Models or trade names of vehicles constituting the vehicle type, if available:
  - 1.5. Manufacturer's name and address:
2. Make and type of brake linings
  - 2.1. Brake linings tested to all relevant prescriptions of Annex II:
  - 2.2. Brake linings tested to Annex XII:
3. Minimum mass of vehicle:
  - 3.1. Distribution of mass of each axle (minimum value):
4. Maximum mass of vehicle:
  - 4.1. Distribution of mass of each axle (maximum value):
5. Maximum vehicle speed:
6. Tyre and wheel dimensions:
7. Brake circuit configuration (e.g. front/rear or diagonal split):
8. Declaration of which system is the secondary braking system:
9. Specifications of brake valves (if applicable)
  - 9.1. Adjustment specifications of the load sensing valve:
  - 9.2. Setting of pressure valve:
10. Designed brake force distribution:
11. Specification of brake
  - 11.1. Disc brake type  
(e.g. number of pistons with diameter(s), ventilated or solid disc):
  - 11.2. Drum brake type  
(e.g. simplex/duplex, with piston size and drum dimensions):
  - 11.3. In the case of compressed air brake systems, e.g. type and size of chambers, levers, etc.:
12. Master cylinder type and size:
13. Booster type and size:

## ▼M7

## ANNEX X

**Test requirements for vehicles with anti-lock braking systems**

1. GENERAL
  - 1.1. This Annex defines the required braking performance for road vehicles fitted with anti-lock braking systems. In addition, motor vehicles which are authorised to tow a trailer, and trailers equipped with compressed-air braking systems, shall, when the vehicles are laden, meet the requirements for compatibility set out in the Appendix to point 1.1.4.2 of Annex II.
  - 1.2. The anti-lock braking systems known at present comprise a sensor or sensors, a controller or controllers and a modulator or modulators. Any systems of a different design which may be introduced in the future will be deemed to be anti-lock braking systems within the meaning of this Annex and the Appendix to point 1.1.4.2 of Annex II, if they provide performances equal to those prescribed by this Annex.
2. DEFINITIONS
  - 2.1. An 'anti-lock braking system' is part of a service braking system which automatically controls the degree of slip, in the direction of rotation of the wheel(s), on one or more wheels of the vehicle during braking.
  - 2.2. 'Sensor' means a component designed to identify and transmit to the controller the conditions of rotation of the wheel(s) or the dynamic conditions of the vehicle.
  - 2.3. 'Controller' means a component designed to evaluate the data transmitted by the sensor(s) and to transmit a signal to the modulator.
  - 2.4. 'Modulator' means a component designed to vary the braking force(s) in accordance with the signal received from the controller.
  - 2.5. 'Directly controlled wheel' means a wheel whose braking force is modulated according to data provided at least by its own sensor<sup>(1)</sup>.
  - 2.6. 'Indirectly controlled wheel' means a wheel whose braking force is modulated according to data provided by the sensor(s) of other wheel(s)<sup>(1)</sup>.
3. TYPES OF ANTI-LOCK BRAKING SYSTEMS
  - 3.1. A motor vehicle shall be deemed to be equipped with an anti-lock braking system within the meaning of point 1 of the Appendix to point 1.1.4.2 of Annex II, if one of the following systems is fitted:
    - 3.1.1. **Category 1 anti-lock braking system:**  
A vehicle equipped with a category 1 anti-lock braking system shall meet all the relevant requirements of this Annex.
    - 3.1.2. **Category 2 anti-lock braking system:**  
A vehicle equipped with a category 2 anti-lock braking system shall meet all the relevant requirements of this Annex, except those of point 5.3.5.
    - 3.1.3. **Category 3 anti-lock braking system:**  
A vehicle equipped with a category 3 anti-lock braking system shall meet all the relevant requirements of this Annex except those of points 5.3.4 and 5.3.5. On such vehicles, any individual axle (or bogie) which does not include at least one directly controlled wheel shall fulfil the conditions of adhesion utilisation and the wheel-locking sequence of the Appendix to point 1.1.4.2. of Annex II, instead of the adhesion utilisation requirements prescribed in point 5.2 of this Annex. However, if the relative positions of the adhesion utilisation curves do not meet the

<sup>(1)</sup> Anti-lock braking systems with 'select-high' control are deemed to include both directly and indirectly controlled wheels; in systems with 'select-low' control, all sensed wheels are deemed to be directly controlled wheels.



## ▼M7

requirements of point 3.1.1 of the Appendix to point 1.1.4.2 of Annex II, a check shall be made to ensure that the wheels on at least one of the rear axles do not lock before those on the front axle or axles under the conditions prescribed in points 3.1.1 and 3.1.4 of the Appendix to point 1.1.4.2 of Annex II with regard to the braking rate and the load respectively. These requirements may be checked on high- or low-adhesion road surfaces (about 0,8 and 0,3 maximum) by modulating the service braking control force.

- 3.2. A trailer shall be deemed to be equipped with an anti-lock braking system within the meaning of point 1 of the Appendix to point 1.1.4.2 of Annex II, when at least two wheels on opposite sides of the vehicle are directly controlled and all remaining wheels are either directly or indirectly controlled by the anti-lock braking system. In the case of full trailers, at least two wheels on one front axle and two wheels on one rear axle shall be directly controlled with each of these axles having at least one independent modulator and all remaining wheels are either directly or indirectly controlled. In addition, the anti-lock equipped trailer shall meet one of the following conditions:
- 3.2.1. **Category A anti-lock braking system:**
- A trailer equipped with a category A anti-lock braking system shall meet all the relevant requirements of this Annex.
- 3.2.2. **Category B anti-lock braking system:**
- A trailer equipped with a category B anti-lock braking system shall meet all the relevant requirements of this Annex, except point 6.3.2.
4. **GENERAL REQUIREMENTS**
- 4.1. Any electrical failure or sensor anomaly that affects the system with respect to the functional and performance requirements in this Annex, including those in the supply of electricity, the external wiring to the controller(s), the controller(s) <sup>(1)</sup> and the modulator(s) shall be signalled to the driver by a specific optical warning signal.
- 4.1.1. The warning signal shall light up when the anti-lock braking system is energised and, with the vehicle stationary, it shall be verified that none of the above-mentioned defects are present before extinguishing the signal.
- 4.1.2. The static sensor check may verify that a sensor was not functioning the last time that the vehicle was at a speed greater than 10 km/h <sup>(2)</sup>. Also during this verification phase, the electrically controlled pneumatic modulator valve(s) shall cycle at least once.
- 4.2. Motor vehicles equipped with an anti-lock braking system and authorised to tow a trailer equipped with such a system, with the exception of vehicles of categories M<sub>1</sub> and N<sub>1</sub>, shall be fitted with a separate optical warning signal for the anti-lock braking system of the trailer, meeting the requirements of point 4.1 of this Annex.
- 4.2.1. This warning signal shall not light up when a trailer without an anti-lock braking system is coupled or when no trailer is coupled. This function shall be automatic.

<sup>(1)</sup> Until uniform test procedures have been agreed, the manufacturer shall provide the technical service with an analysis of potential failures within the controller(s) and their effects. This information shall be subject to discussion and agreement between the technical service and the vehicle manufacturer.

<sup>(2)</sup> The warning signal may light up again while the vehicle is stationary, provided that it is extinguished before the vehicle speed reaches 10 km/h when no defect is present.

▼ M7

- 4.3. The abovementioned optical warning signal(s) shall be visible even in daylight and it shall be easy for the driver to check that they are in working order.
- 4.4. Except for vehicles of categories M<sub>1</sub> and N<sub>1</sub>, O<sub>1</sub> and O<sub>2</sub>, the electrical connections used for the anti-lock braking systems of towing vehicles and trailers shall be effected by a special connector conforming to ISO Standard 7638-1985 or ISO/DIS Standard 7638-1996<sup>(1)</sup>.
- 4.5. In the event of a failure of the anti-lock braking system, the residual braking performance shall be that prescribed for the vehicle in question in the event of a failure of a part of the transmission of the service braking system (see point 2.2.1.4 of Annex I). This requirement shall not be construed as a departure from the requirements concerning secondary braking. In the case of trailers, the residual braking performance in the event of a defect in the anti-lock braking system according to point 4.1 of this Annex shall be at least 80 % of the laden prescribed performance for the service braking system of the relevant trailer.
- 4.6. The operation of the system shall not be adversely affected by magnetic or electrical fields<sup>(2)</sup>.
- 4.7. A manual device may not be provided to disconnect or change the control mode<sup>(3)</sup> of the anti-lock braking system, except on off-road motor vehicles of categories N<sub>2</sub> or N<sub>3</sub>. Where a device is fitted to N<sub>2</sub> or N<sub>3</sub> off-road motor vehicles, the following conditions shall be met:
- 4.7.1. the motor vehicle with the anti-lock braking system disconnected or the control mode changed by the device referred to in point 4.7 above shall satisfy all the relevant requirements in the Appendix to point 1.1.4.2 of Annex II;
- 4.7.2. an optical warning signal shall inform the driver that the anti-lock braking system has been disconnected or the control mode changed; the anti-lock failure warning signal may be used for this purpose;
- 4.7.3. the anti-lock braking system shall automatically be reconnected/returned to on-road mode when the ignition (start) device is again set to the 'on' (run) position;
- 4.7.4. the vehicle user's handbook provided by the manufacturer should warn the driver of the consequences of manual disconnection or mode change of the anti-lock braking system;
- 4.7.5. the device referred to in point 4.7 above may, in conjunction with the towing vehicle, disconnect/change the control mode of the anti-lock braking system of the trailer; a separate device for the trailer alone is not permitted.
5. SPECIAL PROVISIONS CONCERNING MOTOR VEHICLES
- 5.1. *Energy consumption*
- Braking systems equipped with anti-lock braking systems shall maintain their performance when the service braking control device is fully applied for long periods. Compliance with the requirement shall be verified by means of the following tests:
- 5.1.1. *Test procedure*

<sup>(1)</sup> The wiring specification of point 6.2 of ISO 7638-1985 or point 5.4 of ISO/DIS standard 7638-1996 for the trailer may only be reduced if the trailer is equipped with its own independent fuse. The rating of the fuse shall be such that the current rating of the conductors is not exceeded.

With the exception of vehicles of categories N<sub>3</sub> and O<sub>4</sub>, and until a uniform international standard has been agreed, the electrical connection between towing vehicles and trailers equipped with a 12 volt electrical system shall conform with DIN standard 72570, Part 4.

<sup>(2)</sup> This shall be demonstrated by compliance with the technical requirements laid down in Council Directive 72/245/EEC (OJ L 152, 6.7.1972, p. 15), as last amended by Directive 95/54/EC (OJ L 266, 3.11.1995, p. 1).

<sup>(3)</sup> It is understood that devices changing the control mode of the anti-lock braking system are not subject to point 4.7 if in the changed control mode condition all requirements for the category of anti-lock braking system, with which the vehicle is equipped, are fulfilled. However, in this case points 4.7.2, 4.7.3 and 4.7.4 shall be met.

▼ M7

- 5.1.1.1. The initial energy level in the energy storage device(s) shall be that specified by the manufacturer. This level shall be at least such as to ensure the efficiency prescribed for service braking when the vehicle is laden. The energy storage device(s) for pneumatic auxiliary equipment shall be isolated.
- 5.1.1.2. From an initial speed of not less than 50 km/h, on a surface with a coefficient of adhesion of 0,3 <sup>(1)</sup> or less, the brakes of the laden vehicle shall be fully applied for a time *t*, during which time the energy consumed by the indirectly controlled wheels shall be taken into consideration and all directly controlled wheels shall remain under control of the anti-lock braking system throughout that time.
- 5.1.1.3. The vehicle's engine shall be then stopped or the supply to the energy storage device(s) cut off.
- 5.1.1.4. The service braking control shall be then fully actuated four times in succession with the vehicle stationary.
- 5.1.1.5. When the control is applied for the fifth time, it shall be possible to brake the vehicle with at least the performance prescribed for secondary braking of the laden vehicle.
- 5.1.1.6. During the tests, in the case of a motor vehicle authorised to tow a trailer equipped with a compressed-air braking system, the supply line shall be blocked of and an energy storage device of 0,5 litre capacity shall be connected to the control line (in accordance with point 1.2.2.3 of Annex IV, section A). When the brakes are applied for the fifth time, as provided in point 5.1.1.5, the energy level supplied to the control line shall not be below half the level obtained at a full application starting with the initial energy level.
- 5.1.2. *Additional requirements*
- 5.1.2.1. The coefficient of adhesion of the road surface is measured with the vehicle in question, by the method described in point 1.1 of Appendix 2 to this Annex.
- 5.1.2.2. The braking test shall be conducted with the engine disconnected and idling, and with the vehicle laden.
- 5.1.2.3. The braking time *t* shall be determined by the formula:  

$$t = \frac{v_{\max}}{7}$$
 (but not less than 15 seconds)  
 where *t* is expressed in seconds and  $v_{\max}$  represents the maximum design speed of the vehicle expressed in km/h, with an upper limit of 160 km/h.
- 5.1.2.4. If the time *t* cannot be completed in a single braking phase, further phases may be used, up to a maximum of four in all.
- 5.1.2.5. If the test is conducted in several phases, no fresh energy shall be supplied between the phases of the test. From the second phase, the energy consumption corresponding to the initial brake application may be taken into account, by subtracting one full brake application from the four full applications prescribed in point 5.1.1.4 (and 5.1.1.5, 5.1.1.6 and 5.1.2.6) of this Annex for each of the second, third and fourth phases used in the test prescribed in point 5.1.1 of this Annex as applicable.
- 5.1.2.6. The performance prescribed in point 5.1.1.5 shall be deemed to be satisfied if, at the end of the fourth application, with the vehicle stationary, the energy level in the storage device(s) is at or above that required for secondary braking with the laden vehicle.
- 5.2. *Utilisation of adhesion*
- 5.2.1. The utilisation of adhesion by the anti-lock braking system takes into account the actual increase in braking distance beyond the theoretical minimum. The anti-lock braking system shall be deemed to be satisfactory when the condition

<sup>(1)</sup> Until such test surfaces become generally available, tyres at the limit of wear, and higher values up to 0,4 may be used at the discretion of the technical service. The actual value obtained and the type of tyres and surface shall be recorded.

▼ M7

$$\varepsilon \geq 0,75$$

is satisfied, where  $\varepsilon$  represents the adhesion utilised, as defined in point 1.2 of Appendix 2 to this Annex.

- 5.2.2. The adhesion utilisation ( $\varepsilon$ ) shall be measured on road surfaces with a coefficient of adhesion of 0,3<sup>(1)</sup> or less, and of about 0,8 (dry road), with an initial speed of 50 km/h. To eliminate the effects of differential brake temperatures it is recommended that  $Z_{AL}$  be determined prior to the determination of  $k$ .
- 5.2.3. The test procedure to determine the coefficient of adhesion ( $k$ ) and the formulae for calculation of the adhesion utilisation ( $\varepsilon$ ) shall be those laid down in Appendix 2 to this Annex.
- 5.2.4. The utilisation of adhesion by the anti-lock braking system shall be checked on complete vehicles equipped with anti-lock braking systems of categories 1 or 2. In the case of vehicles equipped with category 3 anti-lock braking systems, only the axle(s) with at least one directly controlled wheel shall satisfy this requirement.
- 5.2.5. The condition  $\varepsilon \geq 0,75$  shall be checked with the vehicle laden and unladen. The laden test on the high-adhesion surface may be omitted if the prescribed force on the control device does not achieve full cycling of the anti-lock braking system. For the unladen test, the control force may be increased up to 100 daN if no cycling is achieved with its full force value<sup>(2)</sup>. If 100 daN is insufficient to make the system cycle, then this test may be omitted. For air braking systems, the air pressure may not be increased above the cut-out pressure for the purpose of this test.

5.3. *Additional checks*

The following additional checks shall be carried out with the engine disconnected, with the vehicle laden and unladen:

- 5.3.1. The wheels directly controlled by an anti-lock braking system shall not lock when the full force<sup>(3)</sup> is suddenly applied on the control device, on the road surfaces specified in point 5.2.2 of this Annex, at an initial speed of 40 km/h and at a high initial speed as indicated in the table below<sup>(4)</sup>:

Condition	Vehicle category	Maximum test speed
High-adhesion surface	— All categories except $N_2$ , $N_3$ laden	$0,8 v_{\max} \leq 120$ km/h
	— $N_2$ , $N_3$ laden	$0,8 v_{\max} \leq 80$ km/h
Low-adhesion surface	— $M_1$ , $N_1$	$0,8 v_{\max} \leq 120$ km/h
	— $M_2$ , $M_3$ $N_2$ except semi-trailer tractors	$0,8 v_{\max} \leq 80$ km/h
	— $N_3$ and semi-trailer tractors $N_2$	$0,8 v_{\max} \leq 70$ km/h

<sup>(1)</sup> Until such test surfaces become generally available, tyres at the limit of wear, and higher values up to 0,4 may be used at the discretion of the technical service. The actual value obtained and the type of tyres and surface shall be recorded.

<sup>(2)</sup> 'Full force' means the maximum force laid down in Annex II for the category of vehicle: a higher force may be used if required to activate the anti-lock braking system.

<sup>(3)</sup> 'Full force' means the maximum force laid down in Annex II for the category of vehicle: a higher force may be used if required to activate the anti-lock braking system.

<sup>(4)</sup> The purpose of these tests is to check that the wheels do not lock and that the vehicle remains stable; it is not necessary, therefore, to make complete stops and bring the vehicle to a complete halt on the low-adhesion surface.

▼ **M7**

- 5.3.2. When an axle passes from a high-adhesion surface ( $k_H$ ) to a low-adhesion ( $k_L$ ) where  $k_H \geq 0,5$  and  $k_H/k_L \geq 2$  <sup>(1)</sup>, with the full force <sup>(2)</sup> applied on the control device, the directly controlled wheels shall not lock. The running speed and the instant of applying the brakes shall be so calculated that, with the anti-lock braking system fully cycling on the high-adhesion surface, the passage from one surface to the other is made at high and at low speed, under the conditions laid down in point 5.3.1 above <sup>(3)</sup>.
- 5.3.3. When a vehicle passes from a low-adhesion surface ( $k_L$ ) to a high-adhesion ( $k_H$ ) where  $k_H \geq 0,5$  and  $k_H/k_L \geq 2$ , with the full force <sup>(4)</sup> applied on the control device, the deceleration of the vehicle shall rise to the appropriate high value within a reasonable time and the vehicle shall not deviate from its initial course. The running speed and the instant of applying the brakes shall be so calculated that, with the anti-lock braking system fully cycling on the low-adhesion surface, the passage from one surface to the other occurs at approximately 50 km/h.
- 5.3.4. In the case of vehicles equipped with anti-lock braking systems of categories 1 and 2, when the right and left wheels of the vehicle are situated on surfaces with differing coefficients of adhesion ( $k_H$  and  $k_L$ ) where  $k_H \geq 0,5$  and  $k_H/k_L \geq 2$ , the directly controlled wheels shall not lock when the full force <sup>(5)</sup> is suddenly applied on the control device at a speed of 50 km/h.
- 5.3.5. Furthermore, laden vehicles equipped with anti-lock braking systems of category 1 shall, under the conditions of point 5.3.4 above, satisfy the prescribed braking rate in Appendix 3 to this Annex.
- 5.3.6. However, in the tests provided for in points 5.3.1, 5.3.2, 5.3.3, 5.3.4 and 5.3.5 above, brief periods of wheel-locking are allowed. Furthermore, wheel-locking is permitted when the vehicle speed is less than 15 km/h; likewise, locking of indirectly controlled wheels is permitted at any speed, but stability and steerability shall not be affected.
- 5.3.7. During the tests provided for in points 5.3.4 and 5.3.5 above, steering correction is permitted if the angular rotation of the steering control is within 120° during the initial 2 seconds and not more than 240° in all. Furthermore, at the beginning of these tests the longitudinal median plane of the vehicle shall pass over the boundary between the high- and low-adhesion surfaces and during these tests no part of the (outer)tyres shall cross this boundary.

## 6. SPECIAL PROVISIONS CONCERNING TRAILERS

6.1. *Energy consumption*

Trailers equipped with anti-lock braking systems shall be so designed that, even after the service braking control device has been fully applied for some time, the vehicle retains sufficient energy to bring it to a halt within a reasonable distance.

- 6.1.1. Compliance with the above requirement shall be checked by the procedure specified below, with the vehicle unladen, on a straight and level road with a surface having a good coefficient of adhesion <sup>(6)</sup>, and with the brakes adjusted as closely as possible and with the brake load sensing device (if fitted) held in the 'laden' position throughout the test.

<sup>(1)</sup>  $k_H$  is the high-adhesion surface coefficient.

$k_L$  is the low-adhesion surface coefficient.

$k_H$  and  $k_L$  are measured as laid down in Appendix 2 to this Annex.

<sup>(2)</sup> 'Full force' means the maximum force laid down in Annex II for the category of vehicle: a higher force may be used if required to activate the anti-lock braking system.

<sup>(3)</sup> The purpose of these tests is to check that the wheels do not lock and that the vehicle remains stable; it is not necessary, therefore, to make complete stops and bring the vehicle to a complete halt on the low-adhesion surface.

<sup>(4)</sup> 'Full force' means the maximum force laid down in Annex II for the category of vehicle: a higher force may be used if required to activate the anti-lock braking system.

<sup>(5)</sup> 'Full force' means the maximum force laid down in Annex II for the category of vehicle: a higher force may be used if required to activate the anti-lock braking system.

<sup>(6)</sup> If the coefficient of adhesion of the test track is too high, preventing the anti-lock braking system from cycling then the test may be carried out on a surface with a lower coefficient of adhesion.

## ▼M7

6.1.2. In the case of compressed-air braking systems, the initial energy level in the energy storage device(s) shall be equivalent to a pressure of 8,0 bar at the coupling head of the trailer's supply line.

6.1.3. With an initial vehicle speed of at least 30 km/h, the brakes shall be fully applied for a time  $t = 15$  s, during which time the energy consumed by the indirectly controlled wheels shall be taken into consideration and all directly controlled wheels shall remain under control of the anti-lock braking system. During this test, the supply to the energy storage device(s) shall be cut off.

If the time  $t = 15$  s cannot be completed in a single braking phase, further phases may be used. During these phases, no fresh energy shall be supplied to the energy storage device(s) and, as from the second phase, the additional energy consumption for filling the actuators is to be taken into account, e.g. by the following test procedure.

The pressure in the reservoir(s) when starting the first phase is to be that stated in point 6.1.2 above. At the beginning of the following phase(s), the pressure in the reservoir(s) after application of the brakes shall be not less than the pressure in the reservoir(s) at the end of the preceding phase. At the subsequent phase(s), the only time to be taken into account is from the point at which the pressure in the reservoir(s) is equal to that at the end of the preceding phase.

6.1.4. At the end of the braking, with the vehicle stationary, the service braking control device shall be fully actuated four times. During the fifth application, the pressure in the operating circuits shall be sufficient to provide a total braking force at the periphery of the wheels equal to not less than 22,5 % of the maximum stationary wheel load and without causing and automatic application of any braking system not being under the control of the anti-lock braking system.

## 6.2. *Utilisation of adhesion*

6.2.1. Trailers equipped with an anti-lock braking system shall be deemed acceptable when the condition  $\varepsilon \geq 0,75$  is satisfied, where  $\varepsilon$  represents the adhesion utilised, as defined in point 2 of Appendix 2 to this Annex. This condition shall be verified with the vehicle unladen, on a straight and level road with a surface having a good coefficient of adhesion <sup>(1)</sup> <sup>(2)</sup>.

6.2.2. To eliminate the effects of differential brake temperatures, it is recommended that  $Z_{RAL}$  be determined prior to the determination of  $k_R$ .

## 6.3. *Additional checks*

6.3.1. At speeds exceeding 15 km/h, the wheels directly controlled by an anti-lock braking system shall not lock when the full force <sup>(3)</sup> is suddenly applied on the control device of the towing vehicle. This shall be checked, under the conditions prescribed in point 6.2 of this Annex, at initial speeds of 40 km/h and 80 km/h.

6.3.2. The provisions of this point shall only apply to trailers equipped with an anti-lock braking system of category A.

When the right and left wheels are situated on surfaces which produce differing maximum braking rates ( $Z_{RALH}$  and  $Z_{RALL}$ ), where

$$\frac{Z_{RALH}}{\varepsilon_H} \geq 0,5 \text{ and } \frac{Z_{RALH}}{Z_{RALL}} \geq 2$$

the directly controlled wheels shall not lock when the full force <sup>(4)</sup> is suddenly applied on the control device of the towing vehicle at

<sup>(1)</sup> If the coefficient of adhesion of the test track is too high, preventing the anti-lock braking system from cycling then the test may be carried out on a surface with a lower coefficient of adhesion.

<sup>(2)</sup> In the case of trailers fitted with a brake load sensing device the pressure setting may be increased to ensure full cycling.

<sup>(3)</sup> 'Full force' means the maximum force laid down in Annex II for the category of vehicle: a higher force may be used if required to activate the anti-lock braking system.

<sup>(4)</sup> 'Full force' means the maximum force laid down in Annex II for the category of vehicle: a higher force may be used if required to activate the anti-lock braking system.

**▼M7**

a speed of 50 km/h. The ratio  $z_{RALH}/z_{RALL}$  may be ascertained by the procedure in point 2 of Appendix 2 to this Annex or by calculating the ratio  $z_{RALH}/z_{RALL}$ . Under this condition, the unladen vehicle shall satisfy the prescribed braking rate in Appendix 3 of this Annex <sup>(1)</sup>.

- 6.3.3. At vehicle speeds  $\geq 15$  km/h, the directly controlled wheels are permitted to lock for brief periods, but at speeds  $< 15$  km/h, any locking is permissible. Indirectly controlled wheels are permitted to lock at any speed. In all cases, stability must not be affected.

<sup>(1)</sup> In the case of trailers fitted with a brake load sensing device the pressure setting may be increased to ensure full cycling.

▼ **M7**

*Appendix 1*  
**Symbols and definitions**

Symbol	Notes
$E$	wheelbase
$E_R$	distance between king-pin and centre of axle of semi-trailer (or distance between drawbar coupling and centre of axle or axles of centre-axle trailer)
$\varepsilon$	the adhesion utilised by the vehicle: quotient of the maximum braking rate with the anti-lock braking system operative ( $z_{AL}$ ) and the coefficient of adhesion ( $k$ )
$\varepsilon_i$	the $\varepsilon$ -value measured on axle $i$ (in the case of a motor vehicle with a category 3 anti-lock system)
$\varepsilon_H$	the $\varepsilon$ -value on the high-friction surface
$\varepsilon_L$	the $\varepsilon$ -value on the low-friction surface
$F$	force [N]
$F_{bR}$	braking force of the trailer with the anti-lock braking system inoperative
$F_{bRmax}$	maximum value of $F_{bR}$
$F_{bRmax,i}$	value of $F_{bRmax}$ with only axle $i$ of the trailer braked
$F_{bRAL}$	braking force of the trailer with the anti-lock braking system operative
$F_{Cnd}$	total normal reaction of road surface on the unbraked and non-driven axles of the vehicle combination under static conditions
$F_{Cd}$	total normal reaction of road surface on the unbraked and driven axles of the vehicle combination under static conditions
$F_{dyn}$	normal reaction of road under dynamic conditions with the anti-lock braking system operative
$F_{idyn}$	$F_{dyn}$ on axle $i$ in case of motor vehicles or full trailers
$F_i$	normal reaction of road surface on axle $i$ under static conditions
$F_M$	total normal static reaction of road surface on all wheels of motor (towing) vehicle
$F_{Mnd}^{(1)}$	total normal static reaction of road surface on the unbraked and non-driven axles of the motor vehicle
$F_{Md}^{(1)}$	total normal static reaction of road surface on the unbraked and driven axles of the motor vehicle
$F_R$	total normal static reaction of road surface on all wheels of trailer
$F_{Rdyn}$	total normal dynamic reaction of road surface on the axle(s) of semi-trailer or centre-axle trailer
$F_{wM}^{(1)}$	$0,01 F_{Mnd} + 0,015 F_{Md}$
$g$	acceleration due to gravity ( $9,81 \text{ m/s}^2$ )



▼ **M7**

Symbol	Notes
$h$	height of centre of gravity specified by the manufacturer and agreed by the technical service conducting the approval test
$h_D$	height of drawbar (hinge point on trailer)
$h_K$	height of fifth wheel coupling (king pin)
$h_R$	height of centre of gravity of the trailer
$k$	coefficient of adhesion between tyre and road
$k_f$	k-factor of one front axle
$k_H$	k-value determined on the high-friction surface
$k_i$	k-value determined on axle $i$ for a vehicle with a category 3 anti-lock braking system
$k_L$	k-value determined on the low-friction surface
$k_{lock}$	value of adhesion for 100 % slip
$k_M$	k-factor of the motor vehicle
$k_{peak}$	maximum value of the curve 'adhesion versus slip'
$k_r$	k-factor of one rear axle
$k_R$	k-factor of the trailer
$P$	mass of individual vehicle [kg]
$R$	ratio of $k_{peak}$ to $k_{lock}$
$t$	time interval [s]
$t_m$	mean value of $t$
$t_{min}$	minimum value of $t$
$z$	braking rate
$z_{AL}$	braking rate $z$ of the vehicle with the anti-lock braking system operative
$z_C$	braking rate $z$ of the vehicle combination, with the trailer only braked and the anti-lock braking system inoperative
$z_{CAL}$	braking rate $z$ of the vehicle combination, with the trailer only braked and the anti-lock braking system operative
$z_{Cmax}$	maximum value of $z_C$
$z_{Cmax,i}$	maximum value of $z_C$ , with only axle $i$ of the trailer braked
$z_m$	mean braking rate
$z_{max}$	maximum value of $z$
$z_{MALS}$	$z_{AL}$ of the motor vehicle on a 'split surface'
$z_R$	braking rate $z$ of the trailer with the anti-lock braking system inoperative

▼ **M7**

Symbol	Notes
$z_{RAL}$	$z_{AL}$ of the trailer obtained by braking all the axles, the towing vehicle unbraked and its engine disconnected
$z_{RALH}$	$z_{RAL}$ on the surface with the high coefficient of adhesion
$z_{RALL}$	$z_{RAL}$ on the surface with the low coefficient of adhesion
$z_{RALS}$	$z_{RAL}$ on the split surface
$z_{RH}$	$z_R$ on the surface with the high coefficient of adhesion
$z_{RL}$	$z_R$ on the surface with the low coefficient of adhesion
$z_{RHmax}$	maximum value of $z_{RH}$
$z_{RLmax}$	maximum value of $z_{RL}$
$z_{Rmax}$	maximum value of $z_R$

(<sup>1</sup>)  $F_{Mnd}$  and  $F_{MD}$ : in case of two-axled motor vehicles: these symbols may be simplified to corresponding  $F_i$  symbols.

## ▼M7

## Appendix 2

## Utilisation of adhesion

1. METHOD OF MEASUREMENT FOR MOTOR VEHICLES
- 1.1. Determination of the coefficient of adhesion (k)
- 1.1.1. The coefficient of adhesion (k) shall be determined as the quotient of the maximum braking forces without locking the wheels and the corresponding dynamic load on the axle being braked.
- 1.1.2. The brakes shall be applied only on one axle of the vehicle under test, at an initial speed of 50 km/h. The braking forces shall be distributed between the wheels of the axle to reach maximum performance. The anti-lock braking system shall be disconnected, or inoperative, between 40 km/h and 20 km/h.
- 1.1.3. A number of tests at increments of line pressure shall be carried out to determine the maximum braking rate of the vehicle ( $z_{\max}$ ).

During each test, a constant input force shall be maintained and the braking rate shall be determined by reference to the time taken (t) for the speed to reduce from 40 km/h to 20 km/h using the formula:

$$z = \frac{0,566}{t}$$

$z_{\max}$  is the maximum value of z

t is in seconds.

- 1.1.3.1. Wheel-lock may occur below 20 km/h.
- 1.1.3.2. Starting from the minimum measured value of t, called  $t_{\min}$ , then select three values of t comprised within  $t_{\min}$  and  $1,05 t_{\min}$  and calculate their arithmetical mean value  $t_m$ ,

then calculate

$$z_m = \frac{0,566}{t_m}$$

If it is demonstrated that for practical reasons the three values determined above cannot be obtained, then the minimum time  $t_{\min}$  may be utilised. However, the requirements of point 1.3 still apply.

- 1.1.4. The braking forces shall be calculated from the measured braking rate and the rolling resistance of the unbraked axle(s) which is equal to 0,015 and 0,010 of the static axle load for a driven axle and a non-driven axle, respectively.
- 1.1.5. The dynamic load on the axle shall be that given by the relations in the Appendix to point 1.1.4.2 of Annex II.
- 1.1.6. The value of k shall be rounded to three decimal places.
- 1.1.7. Then, the test will be repeated for the other axles(s) as defined in points 1.1.1 to 1.1.6 above (for exemptions, see points 1.4 and 1.5 below).
- 1.1.8. For example, in the case of a two-axle rear-wheel drive vehicle, with the front axle<sup>(1)</sup> being braked, the coefficient of adhesion (k) is given by:

$$k_f = \frac{z_m \times P \times g - 0,015 \times F_2}{F_1 + \frac{h}{E} z_m \times P \times g}$$

- 1.1.9. One coefficient will be determined for the front axle  $k_f$  and one for the rear axle  $k_r$ .
- 1.2. *Determination of the adhesion utilised ( $\epsilon$ )*

<sup>(1)</sup> Anti-lock braking systems with 'select-high' control are deemed to include both directly and indirectly controlled wheels; in systems with 'select-low' control, all sensed wheels are deemed to be directly controlled wheels.

▼ **M7**

- 1.2.1. The adhesion utilised ( $\varepsilon$ ) is defined as the quotient of the maximum braking rate with the anti-lock braking system operative ( $z_{AL}$ ) and the coefficient of adhesion  $k_M$ , i. e.

$$\varepsilon = \frac{z_{AL}}{k_M}$$

- 1.2.2. From an initial vehicle speed of 55 km/h, the maximum value for the braking rate ( $z_{AL}$ ) shall be measured with the anti-lock braking system operative. This value for  $z_{AL}$  shall be based on the average value of three tests, as previously described in point 1.1.3 of this Appendix, using the time taken for the speed to reduce from 45 km/h to 15 km/h, according to the following formula:

$$z_{AL} = \frac{0,849}{t_m}$$

- 1.2.3. The coefficient of adhesion  $k_M$  shall be determined by weighting with the dynamic axle loads:

$$k_M = \frac{k_f F_{fdyn} + k_r \times F_{rdyn}}{P \times g}$$

where:

$$F_{fdyn} = F_f + \frac{h}{E} \times z_{AL} \times P \times g$$

$$F_{rdyn} = F_r - \frac{h}{E} \times z_{AL} \times P \times g$$

- 1.2.4. The value of  $\varepsilon$  shall be rounded to two decimal places.
- 1.2.5. In the case of a vehicle equipped with an anti-lock braking system of category 1 or 2, the value of  $z_{AL}$  is based on the whole vehicle, with the anti-lock braking system in operation, and the adhesion utilised ( $\varepsilon$ ) shall be given by the same formula quoted in point 1.2.1 above.
- 1.2.6. In the case of a vehicle equipped with an anti-lock braking system of category 3, the value of  $z_{AL}$  shall be measured on each axle which has at least one directly controlled wheel.

Example: for a two-axle vehicle with an anti-lock braking system acting only on the rear axle (2), the adhesion utilised ( $\varepsilon$ ) is given by:

$$\varepsilon_2 = \frac{z_{AL} \times P \times g - 0,010 \times F_1}{k_2 \times (F_2 - \frac{h}{E} z_{AL} \times P \times g)}$$

This calculation shall be made for each axle having at least one directly controlled wheel.

- 1.3. If  $\varepsilon > 1,00$ , the measurements of coefficients of adhesion shall be repeated. A tolerance of 10 % is acceptable.
- 1.4. For motor vehicles equipped with three axles, only the axle not associated with a close-coupled bogie shall be used to establish a  $k$  value for the vehicle <sup>(1)</sup>.
- 1.5. For vehicles of categories  $N_2$  and  $N_3$  with a wheel base less than 3,80 m and with  $h/E > 0,25$ , the determination of the coefficient of adhesion for the rear axle shall be omitted.

<sup>(1)</sup> Until a uniform test procedure is agreed, vehicles with more than three axles and special vehicles will be subject to consultation with the technical service.

▼ **M7**

- 1.5.1. In that case, the adhesion utilised ( $\varepsilon$ ) is defined as the quotient of the maximum braking rate with the anti-lock braking system operative ( $z_{AL}$ ) and the coefficient of adhesion ( $k_f$ ), i. e.

$$\varepsilon = \frac{z_{AL}}{k_f}$$

2. METHOD OF MEASUREMENT FOR TRAILERS

2.1. *General*

- 2.1.1. The coefficient of adhesion ( $k$ ) shall be determined as the quotient of the maximum braking forces without locking the wheels and the corresponding dynamic load on the axle being braked.

- 2.1.2. The brakes shall be applied on only one axle of the trailer under test, at an initial speed of 50 km/h. The braking forces shall be distributed between the wheels of the axle to reach maximum performance. The anti-lock braking system shall be disconnected or inoperative between 40 km/h and 20 km/h.

- 2.1.3. A number of tests at increments of line pressure shall be carried out to determine the maximum braking rate of the vehicle combination ( $z_{Cmax}$ ) with the trailer only braked. During each test, a constant input force shall be maintained and the braking rate shall be determined by reference to the time taken ( $t$ ) for the speed to reduce from 40 km/h to 20 km/h using the formula:

$$z_c = \frac{0,566}{t}$$

- 2.1.3.1. Wheel-lock may occur below 20 km/h.

- 2.1.3.2. Starting from the minimum measured value of  $t$ , called  $t_{min}$ , then select three values of  $t$  comprised within  $t_{min}$  and  $1,05 t_{min}$  and calculate their arithmetical mean value  $t_m$ .

then calculate:

$$z_{cmax} = \frac{0,566}{t_m}$$

If it is demonstrated that for practical reasons the three values determined above cannot be obtained, then the minimum time  $t_{min}$  may be utilised.

- 2.1.4. The adhesion utilised ( $\varepsilon$ ) shall be calculated by means of the formula:

$$\varepsilon = \frac{z_{RAL}}{k_R}$$

The  $k$  value shall be determined according to point 2.2.3 for full trailers or point 2.3.1 for semi-trailers, respectively.

- 2.1.5. If  $\varepsilon > 1,00$  the measurements of coefficients of adhesion shall be repeated. A tolerance of 10 % is accepted.

- 2.1.6. The maximum braking rate ( $z_{RAL}$ ) shall be measured with the anti-lock braking system operative and the towing vehicle unbraked, based on the average value of three tests, as in point 2.1.3 of this Appendix.

2.2. *Full trailers*

- 2.2.1. The measurement of  $k$  (with the anti-lock braking system being disconnected, or inoperative, between 40 km/h and 20 km/h) shall be performed for the front and rear axles.

For one front axle  $i$ :

$$F_{bRmaxi} = z_{cmaxi} (F_M + F_R) - 0,01F_{cnd} - 0,015F_{cd}$$

▼ M7

$$F_{\text{idyn}} = F_i + \frac{z_{\text{cmax}}(F_M \times h_D + g \times P \times h_R) - F_{\text{wM}} \times h_D}{E}$$

$$k_f = \frac{F_{\text{bRmaxi}}}{F_{\text{idyn}}}$$

For one rear axle i:

$$F_{\text{bRmaxi}} = z_{\text{cmaxi}}(F_M + F_R) - 0,01F_{\text{cnd}} - 0,015F_{\text{cd}}$$

$$F_{\text{idyn}} = F_i - \frac{z_{\text{cmax}}(F_M \times h_D + g \times P \times h_R) - F_{\text{wM}} \times h_D}{E}$$

$$k_r = \frac{F_{\text{bRmaxi}}}{F_{\text{idyn}}}$$

2.2.2. The values of  $k_f$  and  $k_r$  shall be rounded to three decimal places.

2.2.3. The coefficient of adhesion  $k_R$  shall be determined proportionally according to the dynamic axle loads.

$$k_R = \frac{k_f \times F_{\text{idyn}} + k_r \times F_{\text{rdyn}}}{P \times g}$$

2.2.4. Measurement of  $z_{\text{RAL}}$  (with the anti-lock braking system operative)

$$z_{\text{RAL}} = \frac{z_{\text{CAL}} \times (F_M + F_R) - 0,01F_{\text{Cnd}} - 0,015F_{\text{Cd}}}{F_R}$$

$z_{\text{RAL}}$  shall be determined on a surface with a high coefficient of adhesion and, for vehicles with a category A anti-lock braking system, also on a surface with a low coefficient of adhesion.

2.3. *Semi-trailers and centre-axle trailers*

2.3.1. The measurement of  $k$  (with the anti-lock braking system being disconnected, or inoperative, between 40 km/h and 20 km/h) shall be carried out with wheels fitted only on one axle, the wheels of the other axle(s) are removed.

$$F_{\text{bRmax}} = z_{\text{cmax}} \times (F_M + F_R) - F_{\text{wM}}$$

$$F_{\text{Rdyn}} = F_R - \frac{F_{\text{bRmax}} \times h_k + z_C \times g \times P \times (h_R - h_K)}{E_R}$$

$$k = \frac{F_{\text{bRmax}}}{F_{\text{Rdyn}}}$$

**▼M7**

- 2.3.2. The measurement of  $z_{RAL}$  (with the anti-lock braking system operative) shall be carried out with all wheels fitted.

$$F_{bRAL} = z_{CAL} \times (F_M + F_R) - F_{wM}$$

$$F_{Rdyn} = F_R - \frac{F_{bRAL} \times h_k + z_C \times g \times P \times (h_R - h_K)}{E_R}$$

$$\frac{z_{RAL} = F_{bRAL}}{F_{Rdyn}}$$

$z_{RAL}$  shall be determined on a surface with a high coefficient of adhesion and, for vehicles with a category A anti-lock braking system, also on a surface with a low coefficient of adhesion.

▼ M7*Appendix 3***Performance on differing adhesion surfaces**

1. MOTOR VEHICLES
  - 1.1. The prescribed braking rate referred to in point 5.3.5 of this Annex may be calculated by reference to the measured coefficient of adhesion of the two surfaces on which this test is carried out.  
  
These two surfaces shall satisfy the conditions prescribed in point 5.3.4 of this Annex.
  - 1.2. The coefficient of adhesion ( $k_H$  and  $k_L$ ) of the high- and low-adhesion surfaces, respectively, shall be determined in accordance with the provisions in point 1.1 of Appendix 2 to this Annex.
  - 1.3. The braking rate ( $z_{MALS}$ ) for laden motor vehicles shall be:

$$z_{MALS} \geq 0,75 \frac{4k_L + k_H}{5} \text{ and } z_{MALS} \geq k_L$$

2. TRAILERS
  - 2.1. The braking rate referred to in point 6.3.2 of this Annex may be calculated by reference to the measured braking rates  $z_{RALH}$  and  $z_{RALL}$  on the two surfaces on which the tests are carried out with the anti-lock braking system operative. These two surfaces shall satisfy the conditions prescribed in point 6.3.2 of this Annex.
  - 2.2. The braking rate  $z_{RALS}$  shall be:

$$z_{RALS} \geq \frac{0,75}{\varepsilon_H} \times \frac{4z_{RALL} + z_{RALH}}{5}$$

and

$$z_{RALS} > \frac{z_{RALL}}{\varepsilon_H}$$

If  $\varepsilon_H > 0,95$  use  $\varepsilon_H = 0,95$ .



▼ **M7***Appendix 4***Method of selection of the low-adhesion surface**

1. Details of the coefficient of adhesion of the surface selected, as determined in point 5.1.1.2 of this Annex, shall be given to the technical service.
  - 1.1. These data shall include a curve of the coefficient of adhesion versus slip (from 0 to 100 % slip) for a speed of approximately 40 km/h <sup>(1)</sup>.
    - 1.1.1. The maximum value of the curve will represent  $k_{\text{peak}}$  and the value at 100 % slip will represent  $k_{\text{lock}}$ .
    - 1.1.2. The ratio R shall be determined as the quotient of the  $k_{\text{peak}}$  and  $k_{\text{lock}}$ .
 
$$R = \frac{k_{\text{peak}}}{k_{\text{lock}}}$$
    - 1.1.3. The value of R shall be rounded to one decimal place.
    - 1.1.4. The surface to be used shall have a ratio R between 1,0 and 2,0 <sup>(2)</sup>.
2. Prior to the tests, the technical service shall ensure that the selected surface meets the specified requirements and shall be informed of the following:
  - test method to determine R,
  - type of vehicle (motor vehicle, trailer, etc.),
  - axle load and tyres (different loads and different tyres have to be tested and the results shown to the technical service which will decide if they are representative for the vehicle to be approved).
  - 2.1. The value of R shall be mentioned in the test report.  
The calibration of the surface has to be carried out at least once a year with a representative vehicle to verify the stability of R.

<sup>(1)</sup> Until a uniform test procedure is established for the determination of the adhesion curve for vehicles with a maximum mass exceeding 3,5 tonnes, the curve established for passenger cars may be used. In this case, for vehicles with a maximum mass exceeding 3,5 tonnes, the ratio  $k_{\text{peak}}$  to  $k_{\text{lock}}$  shall be established using a value of  $k_{\text{peak}}$  as defined in Appendix 2 of this Annex. With the consent of the technical service, the coefficient of adhesion described in this item may be determined by another method provided that the equivalence of the values of  $k_{\text{peak}}$  and  $k_{\text{lock}}$  are demonstrated.

<sup>(2)</sup> Until such test surfaces become generally available, a ratio R up to 2,5 is acceptable, subject to discussion with the technical service.

## ▼M7

## ANNEX XI

**Test conditions for trailers with electrical braking systems**

1. GENERAL
  - 1.1. For the purposes of the following provisions, electrical brakes are service braking systems consisting of a control device, an electro-mechanical transmission device, and friction brakes. The electrical control device regulating the voltage for the trailer shall be situated on the trailer.
  - 1.2. The electrical energy required for the electrical braking system shall be supplied to the trailer by the motor vehicle.
  - 1.3. Electrical braking systems shall be actuated by operating the service braking system of the motor vehicle.
  - 1.4. The nominal voltage rating shall be 12 V.
  - 1.5. The maximum current consumption shall not exceed 15 A.
  - 1.6. The electrical connection of the electrical braking system to the motor vehicle shall be effected by means of a special plug and socket connection corresponding to ... <sup>(1)</sup>, the plug of which shall not be compatible with the sockets of the lighting equipment of the vehicle. The plug together with the cable shall be situated on the trailer.
2. CONDITIONS CONCERNING THE TRAILER
  - 2.1. If there is a battery on the trailer fed by the power supply unit of the motor vehicle, it shall be separated from its supply line during service braking of the trailer.
  - 2.2. With trailers whose unladen mass is less than 75 % of their maximum mass the braking force shall be automatically regulated as a function of the loading condition of the trailer.
  - 2.3. Electrical braking systems shall be such that even if the voltage in the connection lines is reduced to a value of 7 V, a braking effect of 20 % of the (sum of the) maximum stationary axle load(s) shall be maintained.
  - 2.4. Control devices for regulating the braking force, which react to the inclination in the direction of travel (pendulum, spring-mass-system, liquid-inertia-switch) shall be attached to the chassis if the trailer has more than one axle and a vertically adjustable towing device. In the case of single-axle trailers and trailers with close-coupled axles where the axle spread is less than 1 metre, these control devices shall be equipped with a mechanism indicating its horizontal position (e.g. spirit level) and shall be manually adjustable to allow the mechanism to be set in the horizontal plane in line with the direction of travel of the vehicle.
  - 2.5. The relay for actuating the braking current in accordance with point 2.2.1.20 of Annex I, which is connected to the actuating line, shall be situated on the trailer.
  - 2.6. A dummy socket shall be provided for the plug.
  - 2.7. A tell-tale shall be provided at the control device, lighting up at any brake application and indicating the proper functioning of the trailer electrical braking system.
3. PERFORMANCE
  - 3.1. Electrical braking systems shall respond at a deceleration of the tractor/trailer combination of not more than 0,4 m/s<sup>2</sup>.
  - 3.2. The braking effect may commence with an initial braking force, which shall not be higher than 10 % of the (sum of the) maximum stationary axle load(s) nor higher than 13 % of the (sum of the) stationary axle load(s) of the unladen trailer.

<sup>(1)</sup> Under study. Until the characteristics of this special connection have been determined, the type to be used will be indicated by the national authority granting the approval.

**▼M7**

- 3.3. The braking forces may also be increased in steps. At higher levels of the braking forces than those referred to in point 3.2 these steps shall be not higher than 6 % of the sum of the maximum stationary axle loads, nor higher than 8 % of the (sum of the) stationary axle load(s) of the unladen trailer. However, in the case of single-axle trailers having a maximum mass not exceeding 1,5 tonnes, the first step shall not exceed 7 % of the sum of the maximum stationary axle loads of the trailer. An increase of 1 % of this value shall be permitted for the subsequent steps (e.g. first step 7 %, second step 8 %, third step 9 %, etc.; any further step should not exceed 10 %). For the purpose of these provisions a two-axle trailer having a wheelbase shorter than 1 metre shall be considered as a single-axle trailer.
- 3.4. The prescribed braking force of the trailer of at least 50 % of the maximum total axle load shall be attained — with maximum mass — in the case of a mean fully developed deceleration of the tractor/trailer combination of not more than 5,9 m/s<sup>2</sup> with multi-axle trailers. Trailers with close-coupled axles where the axle spread is less than 1 metre shall also be considered as single-axle trailers within the meaning of this provision. Moreover, the limits as defined in the Appendix to this Annex shall be observed. If the braking force is regulated in steps, they shall lie within the range shown in the Appendix to this Annex.
- 3.5. The test shall be carried out with an initial speed of 60 km/h.
- 3.6. Automatic braking of the trailer shall be provided in accordance with the conditions of point 2.2.2.9 of Annex I. If this automatic braking action requires electrical energy, a trailer braking force of at least 25 % of the maximum total axle load shall be guaranteed for at least 15 minutes to satisfy the abovementioned conditions.

▼ M7

## Appendix

## Compatibility of the braking rate of the trailer and the mean fully developed deceleration of the tractor/trailer combination

(Trailer laden and unladen)

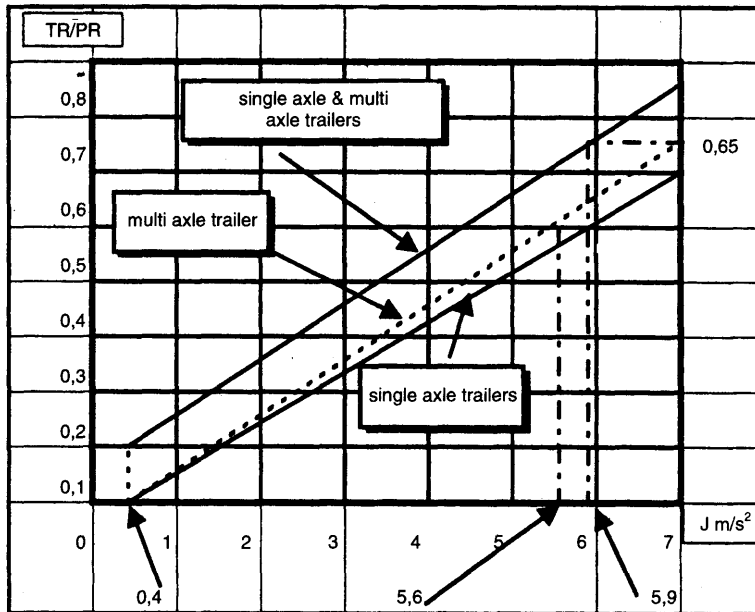

## Notes:

1. Limits indicated in the diagram refer to laden and unladen trailers. When the trailer unladen mass exceeds 75 % of its maximum mass, limits shall be applied only to 'laden' conditions.
2. Limits indicated in the diagram shall not affect the provisions of this Annex regarding the minimum braking performances required. However, if braking performances obtained during the test — in accordance with provisions indicated in point 3.4 above — are greater than those requested, do not exceed the limits indicated in the above diagram.

TR = sum of braking forces at periphery of all wheels of trailer.

PR = total normal static reaction of road surface on wheels of trailer.

J = mean fully developed deceleration of tractor/trailer combination.

▼ **M7***ANNEX XII***Inertia dynamometer test method for brake linings**

1. GENERAL
  - 1.1. The procedure described in this Annex may be applied in the event of a modification of vehicle-type resulting from the fitting of brake linings of another type to vehicles which have been approved in accordance with this Directive.
  - 1.2. The alternative types of brake linings shall be checked by comparing their performance with that obtained from the brake linings with which the vehicle was equipped at the time of approval and conforming to the components identified in the relevant information document, a model of which is given in Annex XVIII or Annex XIX.
  - 1.3. The technical authority responsible for conducting approval tests may, at its discretion, require comparison of the performance of the brake linings to be carried out in accordance with the relevant provisions contained in Annex II.
  - 1.4. Application for approval by comparison shall be made by the vehicle manufacturer.
  - 1.5. In the context of this Annex 'vehicle' means the vehicle-type approved according to this Directive and for which it is requested that the comparison shall be considered satisfactory.
2. TEST EQUIPMENT
  - 2.1. A dynamometer having the following characteristics shall be used:
    - 2.1.1. it shall be capable of generating the inertia required by point 3.1 of this Annex, and have the capacity to meet the requirements prescribed by points 1.3, 1.4 and 1.6 of Annex II with respect to Type I, Type II and Type III fade tests;
    - 2.1.2. the test brakes fitted shall be identical with those of the original vehicle-type concerned;
    - 2.1.3. air cooling, if provided, shall be in accordance with point 3.4 of this Annex;
    - 2.1.4. the instrumentation for the test shall be capable of providing at least the following data:
      - 2.1.4.1. a continuous recording of disc or drum rotational speed;
      - 2.1.4.2. number of revolutions completed during a stop, to resolution not greater than one eighth of a revolution;
      - 2.1.4.3. stop time;
      - 2.1.4.4. a continuous recording of the temperature measured in the centre of the path swept by the lining or a mid-thickness of the disc or drum or lining;
      - 2.1.4.5. a continuous recording of brake application control line pressure or force;
      - 2.1.4.6. a continuous recording of brake output torque.
3. TEST CONDITIONS
  - 3.1. The dynamometer shall be set as close as possible, with  $\pm 5\%$  tolerance, to the rotary inertia equivalent to that part of the total inertia of the vehicle braked by the appropriate wheel(s) according to the following formula:

$$I = MR^2$$

where:

I = rotary inertia (kgm<sup>2</sup>)

R = dynamic tyre rolling radius(m)

M = that part of the maximum mass of the vehicle braked by the appropriate wheel(s).

## ▼M7

- In the case of a single-ended dynamometer, this part shall be calculated from the design braking distribution in the case of motor vehicles when deceleration corresponds to the appropriate value given in point 2.1.1.1.1 of Annex II; in the case of trailers, the value of M shall correspond to the load on the ground for the appropriate wheel when the vehicle is stationary and loaded to its maximum mass.
- 3.2. The initial rotational speed of the inertia dynamometer shall correspond to the linear speed of the vehicle as prescribed in Annex II and shall be based on the rolling radius of the tyre;
- 3.3. Brake linings shall be at least 80 % bedded and shall not have exceeded a temperature of 180 °C during the bedding procedure, or alternatively, at the vehicle manufacturer's request, be bedded in accordance with his recommendations.
- 3.4. Cooling air may be used, flowing over the brake in a direction perpendicular to its axis of rotation. The velocity of the cooling air flowing over the brake shall not be greater than 10 km/h. The temperature of the cooling air shall be the ambient temperature.
4. TEST PROCEDURE
- 4.1. Five sample sets of the brake lining shall be subjected to the comparison test. They shall be compared with five sets of linings conforming to the original components identified in the information document concerning the first approval of the vehicle-type concerned.
- 4.2. Brake lining equivalence shall be based on a comparison of the results achieved using the test procedures prescribed in this Annex and in accordance with the following requirements:
- 4.3. *Type 0 cold performance test*
- 4.3.1. Three brake applications shall be made when the initial temperature is below 100 °C. The temperature shall be measured in accordance with the provisions of point 2.1.4.4.
- 4.3.2. In the case of brake linings intended for use on vehicles of categories M and N, brake applications shall be made from an initial rotational speed equivalent to that given in point 2.1.1.1.1 of Annex II and the brake shall be applied to achieve a mean torque equivalent to the mean fully developed deceleration prescribed in that item. In addition, tests shall be carried out at several rotational speeds, the lowest being equivalent to 30 % of the maximum speed of the vehicle and the highest being equivalent to 80 % of that speed.
- 4.3.3. In the case of brake linings intended for use on vehicles of category O, brake applications shall be made from an initial rotational speed equivalent to 60 km/h, and the brake shall be applied to achieve a mean torque equivalent to that prescribed in point 2.2.1 of Annex II. A supplementary cold performance test from an initial rotational speed equivalent to 40 km/h shall be carried out for comparison with the Type I test result as described in point 2.2.1.2.1 of Annex II.
- 4.3.4. The mean braking torque during the above cold performance tests on the linings being tested for the purpose of comparison shall, for the same input measurement, be within the test limits  $\pm 15$  % of the mean braking torque recorded with the brake linings conforming to the component identified in the relevant application for vehicle type approval.
- 4.4. *Type I test*
- 4.4.1. With repeated braking
- 4.4.1.1. Brake linings for vehicles of categories M and N shall be tested according to the procedure given in point 1.3.1 of Annex II.
- 4.4.2. With continuous braking
- 4.4.2.1. Brake linings for trailers of category O shall be tested in accordance with point 1.3.2 of Annex II.
- 4.4.3. Hot performance

**▼M7**

- 4.4.3.1. On completion of the tests required under points 4.4.1 and 4.4.2 above, the hot braking performance test specified in point 1.3.3 of Annex II shall be carried out.
- 4.4.3.2. The mean braking torque during the above hot performance tests on the linings being tested for the purpose of comparison shall, for the same input measurement, be within the test limits  $\pm 15\%$  of the mean braking torque recorded with the brake linings conforming to the component identified in the relevant application for vehicle type approval.
- 4.5. *Type II test*
- 4.5.1. This test shall be required only if, on the vehicle-type in question, the friction brakes are used for the Type II test.
- 4.5.2. Brake linings for motor vehicles of category M<sub>3</sub> and N<sub>3</sub> (except those required under point 2.2.1.19 of Annex I to undergo a Type IIA test), shall be tested according to the procedure set out in point 1.4.1 of Annex II. Trailers of category O<sub>4</sub> shall be tested according to the procedure set out in point 1.6. of Annex II
- 4.5.3. Hot performance
- 4.5.3.1. On completion of the test required under point 4.5.2 above, the hot performance test specified in point 1.4.3 of Annex II shall be carried out.
- 4.5.3.2. The mean braking torque during the above hot performance tests on the linings being tested for the purpose of comparison shall, for the same input measurement, be within the test limits  $\pm 15\%$  of the mean braking torque recorded with the brake linings conforming to the component identified in the relevant application for vehicle type approval.
- 4.6. *Fade test (Type III test)*
- 4.6.1. Test with repeated braking
- 4.6.1.1. Brake linings for trailers of category O<sub>4</sub>, shall be tested according to the procedure given in point 1.6 of Annex II to this Directive.
- 4.6.3. Hot performance
- 4.6.3.1. On completion of the tests required under points 4.6.1 and 4.6.2 of this Annex, the hot-braking performance test specified in point 1.6.2 of Annex II to this Directive shall be completed.
- 4.6.3.2. The mean braking torque during the above hot performance test on the linings being tested for the purpose of comparison shall, for the same input measurement, be within the test limits  $\pm 15\%$  of the mean braking torque recorded with the brake linings conforming to the component identified in the relevant application for vehicle type approval.
- 5. INSPECTION OF BRAKE LININGS
- 5.1. Brake linings shall be visually inspected on completion of the tests outlined above to check that they are in satisfactory condition for continued use in normal service.

▼ M7

## ANNEX XIII

**Braking and deviation test for vehicles with temporary-use spare wheels/tyres**

1. GENERAL CONDITIONS
  - 1.1. The test track shall be substantially level and have a surface affording good adhesion.
  - 1.2. The test shall be performed when there is no wind liable to affect the results.
  - 1.3. The vehicle shall be loaded to its maximum mass as determined in point 1.14 of Annex I.
  - 1.4. The axle loads resulting from the loading condition in accordance with point 1.3 of this Annex shall be proportional to the maximum axle loads as determined in point 1.2.1.2.1 of Annex II
  - 1.5. The tyres shall be inflated to the pressure recommended for the vehicle-type by the manufacturer.

## 2. BRAKING AND DEVIATION TEST

- 2.1. The test shall be carried out with the temporary-use spare wheel/tyre fitted alternately in place of one front wheel and one rear wheel. However, if use of the temporary-use spare wheel/tyre is restricted to a specific axle, the test shall be carried out only with the temporary-use spare wheel/tyre fitted to that axle.
- 2.2. The test shall be carried out using the service braking system from an initial speed of 80 km/h with the engine disconnected.
- 2.3. The stopping distance shall not exceed the value resulting from the following formula <sup>(1)</sup>:
 
$$s \leq 0,1v + \frac{v^2}{150}$$

where

s = stopping distance in m

v = initial speed of 80 km/h.

The force applied to the control shall not exceed 500 N.

The mean fully developed deceleration during the test shall not be less than 5,8 m s<sup>-2</sup>.

- 2.4. Tests shall be carried out for each of the fitting conditions of temporary-use spare wheels/tyres specified in point 2.1 of this Annex.
- 2.5. The prescribed braking performance shall be obtained without any wheel-locking, deviation of the vehicle from its intended course, abnormal vibration, abnormal wear of the tyre during the test or excessive steering correction.

<sup>(1)</sup> This formula corresponds to that prescribed for the service braking system performance of vehicles of category M<sub>1</sub> in point 2.1.1.1.1 of Annex II.



▼ **M7***ANNEX XIV***Alternative procedure for testing trailer anti-lock braking system (ABS)**

1. GENERAL
  - 1.1. Testing of a trailer in accordance with Annex X of this Directive may be waived at the time of type-approval of the trailer provided that the anti-lock braking system (ABS) complies with the requirements of this Annex.
2. INFORMATION DOCUMENT
  - 2.1. The manufacturer of the ABS shall supply to the technical service an information document of the system(s) requiring approval. This document shall contain at least the following information:
    - 2.1.1. General
      - 2.1.1.1. Name of manufacturer
      - 2.1.1.2. System name
      - 2.1.1.3. System variations
      - 2.1.1.4. System configurations (e. g. 2S/1M, 2S/2M etc.)
      - 2.1.1.5. Explanation of the basic function and/or philosophy of the system
    - 2.1.2. Applications
      - 2.1.2.1. List of trailer types and ABS configurations for which approval is required.
      - 2.1.2.2. Schematic diagrams of the system configurations installed on the trailers defined in point 2.1.2.1 with consideration given to the following parameters:
        - Sensor locations
        - Modulator locations
        - Lift axles
        - Steering axles
        - Tube: type — bore size(s) and lengths
      - 2.1.2.3. Relationship of tyre circumference to the resolution of the exciter, including tolerances.
      - 2.1.2.4. Tolerance on tyre circumference between one axle and another fitted with the same exciter.
      - 2.1.2.5. Scope of application with respect to suspension type, e. g. balanced mechanical etc. with reference to the manufacturer and model/type.
      - 2.1.2.6. Recommendations on differential brake input torque (if any) in relation to the ABS configuration and trailer bogie.
      - 2.1.2.7. Test data shall be supplied to enable the worst-case axle loading to be determined for the purpose of the energy consumption test. This shall be determined by carrying out a series of tests with incremental axle loads. Operating within the axle load range of  $\pm 10\,000$  N of the maximum energy consumption value, a minimum of five results within this range is required. Additional results shall be supplied to illustrate the trend outside of the maximum consumption range. Based on the above data the test trailer(s) shall be loaded to represent the determined worst-case.
      - 2.1.2.8. Additional information (if applicable) to the application of the anti-lock braking system.
    - 2.1.3. Component description
      - 2.1.3.1. Sensor(s)
        - Function
        - Identification (e.g. part number(s))
      - 2.1.3.2. Controller(s)

▼ M7

- General description and function
  - Identification (e. g. part number(s))
  - Failure modes as defined in point 4.1 of Annex X
  - Additional features (e. g. retarder control, automatic configuration, variable parameters, diagnostics).
- 2.1.3.3. Modulator(s)
- General description and function
  - Identification (e. g. part number(s))
  - Limitations (e. g. maximum delivery volume to be controlled)
- 2.1.3.4. Electrical Equipment
- Circuit diagram(s)
  - Powering methods
  - Warning lamp sequence
- 2.1.3.5. Pneumatic Circuits
- Braking schematics covering the ABS configurations as applied to the trailer types defined in point 2.1.2.1
  - Limitations on pipe/tube sizes and associated lengths that have an effect on system performance (e. g. between modulator and brake chamber)
- 2.1.4. Electro-magnetic compatibility (EMC)
- 2.1.4.1. Compliance with point 4.6. of Annex X concerning EMC in terms of susceptibility and emissions will be fulfilled on submission of a technical file or approval to a recognised standard<sup>(1)</sup>. The file or approval document shall include details of the test method, configurations(s) tested and results obtained.
3. DEFINITION OF TEST VEHICLE(S)
- 3.1. Based on the information supplied in the information document, in particular the trailer applications defined in point 2.1.2.1, the technical service shall carry out tests on representative trailers having up to three axles and equipped with the respective anti-lock braking system/configuration requiring approval — as defined in point 2.1.2.1 of this Annex. Additionally, when selecting the trailers for evaluation consideration shall also be given to the parameters defined in the following paragraphs.
- 3.1.1. Suspension type
- The method of evaluating the performance of the anti-lock braking system relative to the suspension type will be selected in the following way:
- Semi-trailers: For each suspension group e. g. balanced mechanical etc. a representative trailer shall be evaluated.
- Full trailers: Evaluation to be carried out on a representative trailer equipped with any one suspension type.
- 3.1.2. Wheelbase
- For semi-trailers the wheelbase shall not be a limiting factor but for full trailers the shortest wheelbase shall be evaluated.
- 3.1.3. Brake type
- Approval shall be limited to cam brakes but should other brake types become available then comparative testing may be required.
- 3.1.4. Load sensing device
- The utilisation of adhesion shall be determined with the load sensing device set to the laden and unladen conditions. To

<sup>(1)</sup> This shall be demonstrated by compliance with the technical requirements laid down in Council Directive 72/245/EEC (OJ L 152, 6.7.1972, p. 15), as last amended by Directive 95/54/EC (OJ L 266, 8.11.1995, p. 1).

▼ M7

ensure full cycling of the ABS the load sensing device may be adjusted so that the static brake chamber pressure is 1 bar greater than the maximum ABS cycling pressure.

## 3.1.5. Brake actuation

Differentials in the level of actuation shall be recorded for evaluation during the tests to determine the utilisation of adhesion. Results obtained from tests for one trailer may be applied to other trailers of the same type.

## 3.1.6. Energy consumption

The trailer(s) selected to evaluate the ABS shall be such that it is possible to load the axles to the worst case load as defined in point 2.1.2.7.

3.2. For each type of trailer under test, documentation showing brake compatibility as defined by the Appendix to Annex II (diagrams 2 and 4) shall be made available to demonstrate conformity.

3.3. For the purpose of the approval semi-trailers and centre-axle trailers shall be deemed to be of the same vehicle-type.

## 4. TEST SCHEDULE

4.1. The following tests shall be conducted by the technical service on the vehicle(s) defined in point 3 of this annex for each ABS configuration — see point 2.1.4 — taking into consideration the application list defined in point 2.1.2.1. However, worst-case cross referencing may eliminate certain tests. If worst-case testing is actually used, this should be stated in the test report.

## 4.1.1. Utilisation of adhesion

Tests shall be carried out according to the procedure defined in point 6.2 of Annex X for each AS configuration and trailer type, as defined in the information document (point 2.1.2.1).

## 4.1.2. Energy consumption

4.1.2.1. Axle loading — The axle loadings of the trailer being evaluated shall be such as to represent the worst-case condition with respect to energy consumption (point 2.1.2.7).

4.1.2.2. Energy consumption test — Test shall be carried out according to the procedure defined in point 6 of annex X for each ABS configuration.

4.1.2.3. To enable trailers submitted for approval to be checked for conformity to the anti-lock energy consumption requirements (see point 6.1, Annex X), the following checks shall be carried out:

4.1.2.3.1. Prior to the commencement of the energy consumption test (point 4.1.2.2) the relationship ( $R_1$ ) of brake chamber push rod travel ( $s_T$ ) against brake lever length ( $l_T$ ) shall be determined for a brake chamber pressure of 6,5 bar.

Example:  $l_T = 130\text{mm}$ ,  $s_T = 22\text{ mm}$ ,

$$R_1 = \frac{s_T}{l_T} = \frac{22}{130} = 0,169$$

4.1.2.3.2. With the load sensing device set to the laden condition and the initial energy level set according to point 6.1.2 to Annex X the energy storage device(s) shall be isolated from further supply of air. The brakes shall be applied with a control pressure of 6,5 bar at the coupling head and then released. Further applications shall be made until the pressure in the brake chambers is the same as that obtained after following the test procedure defined in points 4.1.2.1 and 4.1.2.2. The number of equivalent brake applications ( $n_c$ ) shall be noted.

4.1.3. Split-friction test Where an anti-lock braking system is to be defined as a category A system then all such ABS configurations shall be subject to the performance requirements of point 6.3.2 of Annex X.

▼ **M7**

- 4.1.4. Low and high speed performance
- 4.1.4.1. With the trailer set as for the utilisation of adhesion evaluation, verification of the low and high speed performance shall be carried out according to 6.3.1 of Annex X.
- 4.1.4.2. Where a tolerance exists between the number of exciter teeth and tyre circumference, functional checks shall be carried out at the extremes of tolerance in accordance with point 6.3 of Annex X. This may be achieved by utilising different tyre sizes or by producing special exciters to simulate the frequency extremes.
- 4.1.5. Additional checks
- The following additional checks shall be carried out with the towing vehicle unbraked and the trailer unladen:
- 4.1.5.1. When an axle/bogie passes from a high-adhesion surface ( $k_H$ ) to a low-adhesion surface ( $k_L$ ) where  $k_H \geq 0,5$  and  $k_H/k_L \geq 2$  with a control pressure at the coupling head of 6,5 bar, the directly controlled wheels shall not lock. The running speed and the instant of applying the trailer brakes is so calculated that with the anti-lock braking system fully cycling on the high-adhesion surface, the passage from one surface to the other being made at approximately 80 km/h and 40 km/h.
- 4.1.5.2. When a trailer passes from a low-adhesion surface ( $k_L$ ) to a high-adhesion surface ( $k_H$ ) where  $k_H \geq 0,5$  and  $k_H/k_L \geq 2$ , with a control pressure at the coupling head of 6,5 bar, the pressure in the brake chambers shall rise to an appropriate high value within a reasonable time and the trailer shall not deviate from its initial course. The running speed and the instant of applying the brake is so calculated that, with the anti-lock braking system fully cycling on the low adhesion surface, the passage from one surface to the other occurs at approximately 50 km/h.
- 4.1.6. Failure mode simulation
- A check shall be made on a test vehicle or simulation rig with respect to the external wiring and compliance to point 4.1 of Annex X.
5. APPROVAL REPORT
- 5.1. An approval report shall be produced, the content of which is defined in Appendix 1 to this Annex.
6. VERIFICATION
- 6.1. *Verification of components and installation*
- The specification of the ABS installed on the trailer to be type approved shall be verified by satisfying each of the following criteria:

	Item	Criteria
6.1.1.	(a) Sensor(s)	No change allowed
	(b) Controller(s)	No change allowed
	(c) Modulator(s)	No change allowed
6.1.2.	Tube size(s) and lengths	
	(a) Reservoir supply to modulator(s)	
	Minimum inside diameter	May be increased
	Maximum overall length	May be reduced
	(b) Modulator delivery to brake chambers	
	Inside diameter	No change allowed
Maximum overall length	May be reduced	
6.1.3.	Warning signal sequence	No change allowed

▼ M7

	Item	Criteria
6.1.4.	Differentials in brake input torque within a bogie	Only approved differentials (if any) permitted
6.1.5.	For other limitations refer to section 4 of the test report as described in Appendix 1 to this Annex	Installation to be within the scope of the limitations defined No deviation allowed

6.2. *Verification of reservoir capacity*

6.2.1. As the range of braking systems and auxiliary equipment used on a trailer is diverse it is not possible to have a table of recommended reservoir capacities. To verify that adequate storage capacity is installed testing may be conducted according to point 6 of Annex X or the procedure defined below should be followed:

6.2.1.1. Brake adjustment shall be such as to represent the conditions of the test trailer(s) on which the anti-lock braking system(s) was approved. On the trailer to be approved the brake chamber push rod travel at a brake chamber pressure of 6,5 bar shall be calculated and set according to the following formula:

Note:

To provide a level of security with respect to the energy storage capacity a safety factor of + 20 % has been included.

$$S_v = l_v \times 1,2 \times R_l$$

Example:

$$l_v = 150 \text{ mm}, R_l = 0,169$$

$$S_v = 150 \times 1,2 \times 0,169 = 30,4 \text{ mm}$$

6.2.1.2. With the brakes adjusted according to point 6.2.1.1 — when a trailer is equipped with automatic wear adjustment devices the automatic adjustment mechanism shall be disabled for the purpose of the test or an equivalent manual adjusting device installed — and the load sensing device set to the laden condition and the initial energy level set according to point 6.1.2 of Annex X, the energy storage device(s) shall be isolated from further supply. The brakes shall be applied with a control pressure of 6,5 bar at the coupling head and then fully released. Further brake applications/releases shall be made up to the number  $n_e$  determined from the test conducted in accordance with point 4.1.2.3.2. During this application, the pressure in the operating circuit shall be sufficient to provide a total braking force at the periphery of the wheels equal to not less than 22,5 % of the maximum stationary wheel load and without causing automatic application of any braking system not being under the control of the anti-lock braking system.

6.3. *Verification of function*

6.3.1. This shall be limited to a dynamic functional check of the anti-lock braking system. To ensure full cycling it may be necessary to adjust the load sensing device or utilise a surface having a low tyre-to-road adhesion.

▼ **M7***Appendix 1***Trailer anti-lock braking system approval report**

Approval Report No: ...

1.           **Identification**
  - 1.1.       Manufacturer of the anti-lock braking system (name and address):
  - 1.2.       System name/model:
2.           **System(s) and installation(s) approved**
  - 2.1.       ABS configuration(s) approved (e.g. 2S/1M, 2S/2M etc.):
  - 2.2.       Range of application (type of trailer and number of axles):
  - 2.3.       Methods of powering:
    - ISO 7638, ISO 1185, etc.
  - 2.4.       Identification of approved sensor(s), controller(s) and modulator(s):
  - 2.5.       Energy consumption — equivalent number of static brake applications and the ratio of actuator stroke against brake lever length:
  - 2.6.       Additional features e.g. retarder control, lift axle configuration etc:
3.           **Test data and results**
  - 3.1.       Test vehicle data:
  - 3.2.       Test surface information:
  - 3.3.       Test results:
    - 3.3.1.     Utilisation of adhesion:
    - 3.3.2.     Energy consumption:
    - 3.3.3.     Split-friction test:
    - 3.3.4.     Low speed performance:
    - 3.3.5.     High speed performance:
    - 3.3.6.     Additional checks:
      - 3.3.6.1.   Transition from high to low-adhesion surfaces:
      - 3.3.6.2.   Transition from low to high-adhesion surfaces:
    - 3.3.7.     Failure mode simulation:
    - 3.3.8.     Functional checks of optional power connections:
    - 3.3.9.     Electro-magnetic compatibility:
4.           **Limitations of installation**
  - 4.1.       Relationship of tyre circumference to the resolution of the exciter:
  - 4.2.       Tolerance on tyre circumference between one axle and another fitted with the same exciter:
  - 4.3.       Suspension type:
  - 4.4.       Differential(s) in brake input torque within a trailer bogie:
  - 4.5.       Wheelbase of full trailer:
  - 4.6.       Brake type:
  - 4.7.       Tube sizes and lengths:
  - 4.8.       Load sensing device application:
  - 4.9.       Warning lamp sequence:
  - 4.10.      Other recommendations/limitations (e.g. locations of sensors, modulator(s), lift axle(s), steering axle(s)):

**▼M7**

5.

**Date of test**

The anti-lock braking system described above complies with the requirements of Annex XIV of Directive 71/320/EEC as last amended by Directive 98/12/EC.

Technical service/approval authority <sup>(1)</sup> conducting the test:

.....  
Signed Date

Approval Authority if different from the Technical Service:

.....  
Signed Date

Attachment:

(Manufacturer's information document).

<sup>(1)</sup> Delete as appropriate.

▼ M7*Appendix 2***Symbols and definitions**

Symbol	Notes
$s_T$	Brake chamber push rod travel of reference test trailer in mm
$l_T$	Brake lever length of reference test trailer in mm
$R_1$	Ratio of $s_T/l_T$
$n_e$	Number of equivalent static brake applications
$l_v$	Brake lever length of trailer to be approved in mm
$s_v$	Brake chamber push rod travel of trailer to be approved in mm



## ▼M7

## ANNEX XV

**EC type-approval of replacement brake lining assemblies as separate technical units**

1. SCOPE
  - 1.1 This Annex applies to the type-approval as separate technical units within the meaning of Article 2 of Directive 70/156/EEC, of brake lining assemblies to be installed on motor vehicles and trailers of categories  $M_1 \leq 3,5$  tonnes,  $M_2 \leq 3,5$  tonnes,  $N_1$ ,  $O_1$  and  $O_2$  as replacement parts.
  - 1.2 Approvals are only mandatory for those replacement brake lining assemblies intended to be fitted to such motor vehicles and trailers which were approved pursuant to Directive 71/320/EEC as amended by this Directive.
2. DEFINITIONS
 

For the purpose of this Annex,

  - 2.1. 'braking equipment' has the meaning assigned in point 1.2 of Annex 1 to this Directive;
  - 2.2. 'friction brake' means the part of the braking equipment in which the forces opposing the movement of a vehicle develop by friction between a brake lining and a wheel disc or drum moving relatively to each other;
  - 2.3. 'brake lining assembly' means a component of a friction brake which is pressed against a drum or disc, respectively, to produce the friction force;
    - 2.3.1. 'shoe assembly' means a brake lining assembly of a drum brake;
      - 2.3.1.1. 'shoe' means a component of a shoe assembly which carries the brake lining;
    - 2.3.2. 'pad assembly' means a brake lining assembly of a disc brake;
      - 2.3.2.1. 'backplate' means a component of a pad assembly which carries the brake lining;
    - 2.3.3. 'brake lining' means the friction material component of a brake lining assembly;
    - 2.3.4. 'friction material' means the product of a specified mixture of materials and processes which together determine the characteristics of a brake lining;
  - 2.4. 'brake lining type' means a category of brake linings which do not differ in friction material characteristics;
  - 2.5. 'brake lining assembly type' means wheel sets of brake lining assemblies which do not differ in brake lining type, dimension or functional characteristics;
  - 2.6. 'original brake lining' means a brake lining type referenced in the vehicle type-approval certificate, Annex IX, Addendum to Appendix 1, point 1.2 and subpoints;
  - 2.7. 'original brake lining assembly' means a brake lining assembly conforming to the data submitted in a vehicle information document;
  - 2.8. 'replacement brake lining assembly' means a brake lining assembly of a type approved under this Directive as a suitable service replacement for an original brake lining assembly;
  - 2.9. 'manufacturer' means the organisation which can assume technical responsibility for the brake lining assemblies and can demonstrate that it possesses the necessary means to achieve conformity of production.
3. APPLICATION FOR EC TYPE-APPROVAL
  - 3.1. An application for EC type-approval pursuant to Article 3(4) of Directive 0/156/EEC of a replacement brake lining assembly type for (a) specific vehicle type(s) shall be submitted by the manufacturer of the replacement brake lining assembly.

**▼M7**

- 3.2. An application may be submitted by the holder of (a) vehicle type-approval(s) to this Directive in respect of replacement brake lining assemblies conforming to the type referenced in the vehicle type-approval certificate, Annex IX, Addendum to Appendix 1, point 1.2 and subpoints.
- 3.3. A model for the information document is given in Annex XVII.
- 3.4. The following must be submitted to the technical service responsible for the type-approval tests:
- 3.4.1 Brake lining assemblies of the type for which approval is sought in sufficient quantity to perform the approval tests. The samples shall be clearly and indelibly marked with the applicant's trade name or mark and the type designation.
- 3.4.2 The suitable representative vehicle(s) and/or brake(s).
4. GRANTING OF EC TYPE-APPROVAL
- 4.1. If the relevant requirements are satisfied, EC Type-Approval pursuant to Article 4(3) and, if applicable, Article 4(4) of Directive 70/156/EEC shall be granted.
- 4.2. A model for the EC type-approval certificate is given in Annex XVI.
- 4.3. An approval number in accordance with Annex VII to Directive 70/156/EEC shall be assigned to each type of replacement brake lining assembly approved. The same Member State shall not assign the same number to another brake lining assembly type. The same type-approval number may cover the use of that brake lining assembly type on a number of differing vehicle types.
- 4.4. MARKING
- 4.4.1. Every replacement brake lining conforming to the type approved under this Directive as a separate technical unit shall bear an EC type-approval mark.
- 4.4.2. This mark shall consist of a rectangle surrounding the letter 'e' followed by the distinguishing number or letters of the Member State which has granted the type-approval:

- 1 for Germany
- 2 for France
- 3 for Italy
- 4 for the Netherlands
- 5 for Sweden
- 6 for Belgium

**▼A2**

- 7 for Hungary
- 8 for the Czech Republic

**▼M7**

- 9 for Spain
- 11 for the United Kingdom
- 12 for Austria
- 13 for Luxembourg
- 17 for Finland
- 18 for Denmark

**▼M9**

- 19 for Romania

**▼A2**

- 20 for Poland

**▼M7**

- 21 for Portugal

▼ M7

23 for Greece

▼ A2

26 for Slovenia

27 for Slovakia

29 for Estonia

32 for Latvia

▼ M9

34 for Bulgaria

▼ A2

36 for Lithuania

CY for Cyprus

▼ M7

IRL for Ireland

▼ A2

MT for Malta.

▼ M7

It must also include in the vicinity of the rectangle the 'base approval number' contained in section 4 of the type-approval number referred to in Annex VII of Directive 70/156/EEC, preceded by the two figures indicating the sequence number assigned to the most recent major technical amendment to Directive 71/320/EEC on the date EC type-approval was granted. In this Directive the sequence number is 01. The additional three digits arranged in the vicinity of the rectangle shall be used to designate the shoe or backplate.

4.4.3. The approval mark referred to in point 4.4.2 above shall be clearly legible and be indelible.

4.4.4. Appendix 1 to this Annex gives examples of arrangements of the approval mark and approval data referred to above and in point 6.5 below.

## 5. SPECIFICATIONS AND TESTS

### 5.1. *General*

A replacement brake lining assembly shall be so designed and constructed that when substituted for the assembly originally fitted to a vehicle the braking efficiency of that vehicle accords with that of the approved vehicle type in compliance with the provisions of Annex II to this Directive.

Specifically:

- (a) a vehicle equipped with replacement brake lining assemblies shall satisfy the relevant braking requirements of this Directive;
- (b) a replacement brake lining assembly shall display performance characteristics similar to that of the original brake lining assembly it is intended to replace;
- (c) a replacement brake lining assembly must possess adequate mechanical characteristics;

5.2. Replacement brake lining assemblies conforming to the type specified in vehicle type-approval documentation to this Directive are deemed to satisfy the requirements of paragraph 5 of this Annex.

### 5.3. *Performance requirements*

5.3.1. Replacement brake lining assemblies for vehicles of categories M<sub>1</sub>, M<sub>2</sub> and N<sub>1</sub>

Replacement brake lining assemblies shall be tested according to the prescriptions of Appendix 2 and must satisfy the requirements stated in this appendix. For speed sensitivity and cold performance

▼ **M7**

- equivalence one of the two methods describes in Appendix 2 shall be used.
- 5.3.2. Replacement brake lining assemblies for vehicles of categories O<sub>1</sub> and O<sub>2</sub>
- Replacement brake lining assemblies shall be tested according to the prescriptions of Appendix 3 and shall satisfy the requirements stated in Appendix 3 and Appendix 4 of this Annex.
- 5.4. *Mechanical characteristics*
- 5.4.1. Replacement brake lining assemblies of the type for which approval is requested shall be tested for shear strength according to ISO 6312: (1981) standard.
- The minimum acceptable shear strength is 250 N/cm<sup>2</sup> for pad assemblies and 100 N/cm<sup>2</sup> for shoe assemblies.
- 5.4.2. Replacement brake lining assemblies of the type for which approval is requested shall be tested for compressibility according to ISO 6310: (1981) standard.
- The compressibility values shall not exceed 2 % at ambient temperature and 5 % at 400 °C for pad assemblies and 2 % at ambient temperature and 4 % at 200 °C for shoe assemblies.
6. PACKAGING AND MARKING
- 6.1. ► **M8** Replacement brake lining assemblies conforming to a type approved in accordance with this Directive shall be packaged in axle sets. ◀
- 6.2. Each axle set shall be contained in a sealed package constructed to show previous opening.
- 6.3. Each package shall display the following information:
- 6.3.1. the quantity of replacement brake lining assemblies in the package;
- 6.3.2. manufacturer's name or trade mark;
- 6.3.3. make and type of replacement brake-lining assemblies;
- 6.3.4. ► **M8** sufficient for the customer to identify the vehicles/axles/-brakes for which the contents are approved; ◀
- 6.3.5. the approval mark.
- 6.4. Each package shall contain fitting instructions:
- 6.4.1. with particular reference to ancillary parts;
- 6.4.2. stating that replacement brake lining assemblies should be replaced in axle sets.
- 6.5. Each replacement brake lining assembly shall display permanently one set of approval data:
- 6.5.1. the approval mark;
- 6.5.2. the date of manufacture, at least month and year;
- 6.5.3. make and type of brake lining.
7. MODIFICATIONS OF THE TYPE AND AMENDMENTS TO APPROVALS
- 7.1. In the case of modifications of the type approved pursuant to this Directive, the provisions of Article 5 of Directive 70/156/EEC shall apply.
8. CONFORMITY OF PRODUCTION
- 8.1. As a general rule measures to ensure the conformity of production shall be taken pursuant to Article 10 of 70/156/EEC.
- 8.2. Original brake lining assemblies being the subject of an application under point 3.2. are deemed to satisfy the requirements of point 8.

▼ M7

- 8.3. The tests referred to in point 2.3.5 of Annex 10 to 70/156/EEC are those prescribed in point 5.4. and in Appendix 4 to this Annex.
- 8.4. The normal frequency of inspections authorised by the competent authority shall be one per year.

▼ M7*Appendix I***Arrangements of the approval mark and approval data**

(see point 4.4 and 6.5 of this Annex)

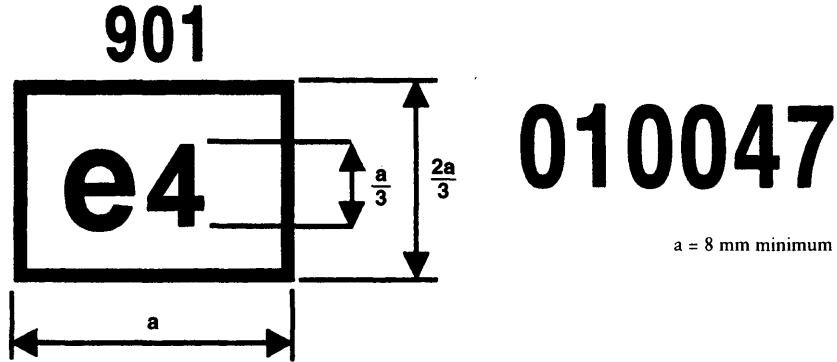

The above approval mark shows that the item concerned has been approved in the Netherlands (e 4), pursuant to this Directive. In this illustration the first two digits (01) refer to the sequence number assigned to the most recent technical amendments made to Council Directive 71/320/EEC; the following four digits (0047) are those allocated by the approval authority to the brake lining type as the base approval number, and the additional three digits (901) arranged in the vicinity of the rectangle are those allocated by the approval authority to the shoe or backplate. All nine digits together comprise the approval mark for that replacement brake lining assembly type.

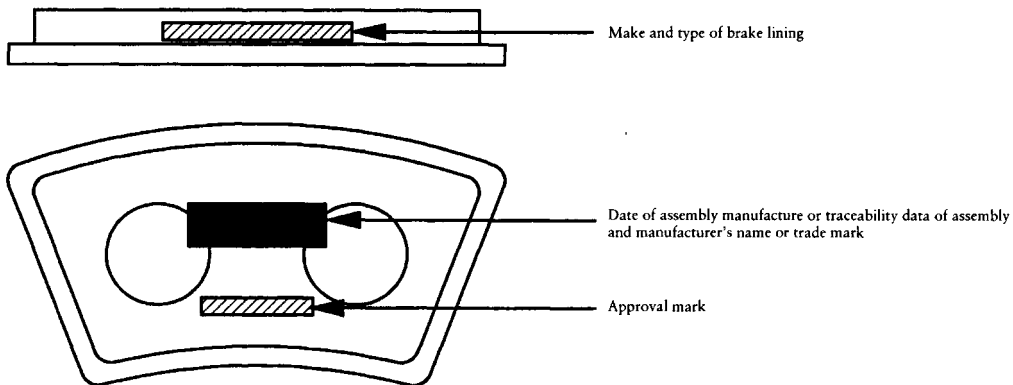
**Example of pad assembly marking**

**▼ M7**

Example of the shoe assembly marking

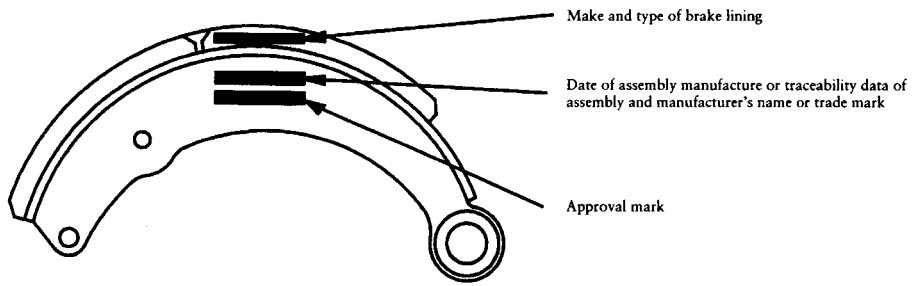

*Note:*

Positions of any these markings shown in the examples above are not mandatory

▼ **M7***Appendix 2***Requirements for replacement brake lining assemblies for vehicles of categories M<sub>1</sub>, M<sub>2</sub> and N<sub>1</sub>**

1. CONFORMANCE WITH THIS DIRECTIVE
 

Compliance with the requirements of this Directive shall be demonstrated in a vehicle test.

  - 1.1. *Test vehicle*

A vehicle which is representative of the type(s) for which the replacement brake lining assembly approval is required shall be equipped with the replacement brake lining assemblies of the type for which approval is requested and instrumented for brake testing as required by the Directive.

Brake linings assemblies submitted for test shall be fitted to the relevant brakes and, until a fixed burnishing procedure is established, shall be burnished to the manufacturer's instructions in agreement with the technical service.
  - 1.2. The braking system of the vehicle shall be tested according to the requirements for the vehicle category in question (M<sub>1</sub>, M<sub>2</sub> or N<sub>1</sub>) in Annex II, points 1 and 2. The applicable requirements or tests are:
    - 1.2.1. Service braking system
      - 1.2.1.1. Type 0 test with engine disconnected, vehicle laden
      - 1.2.1.2. Type 0 test with engine connected, vehicle unladen and laden, according to Annex II, points 1.2.3.1 (stability test) and 1.2.3.2 (only the test with initial speed  $v = 0,8 v_{max}$ )
      - 1.2.1.3. Type I test
    - 1.2.2. Secondary braking system
      - 1.2.2.1. Type 0 test with engine disconnected, vehicle laden (this test may be omitted in cases where it is obvious that the requirements are met, e. g. diagonal split braking system)
    - 1.2.3. Parking braking system
 

(Only applicable if the brakes for which lining approval is sought are used for parking).

      - 1.2.3.1. Downhill test at 18 % gradient, vehicle laden.
  - 1.3. The vehicle must satisfy all the relevant requirements stated in Annex II, point 2 for that category of vehicles.
2. ADDITIONAL REQUIREMENTS
 

Compliance with the additional requirements shall be demonstrated by using one of the two following methods:

  - 2.1. *Vehicle test (split axle test)*

For this test the vehicle shall be fully laden and all brake applications made with engine disconnected, on a level road.

The vehicle service brake control system shall be equipped with a means of isolating front and rear axle brakes so that either may be used independently of the other.

Where brake lining assembly approval is required for front axle brakes the rear axle brakes shall remain inoperative throughout the test.

Where brake lining assembly approval is required for rear axle brakes the front axle brakes shall remain inoperative throughout the test.
  - 2.1.1. Cold performance equivalence test
 

A comparison of the cold performance of the replacement brake lining assembly and the original brake lining assembly shall be made by comparing the results of testing to the following method:



▼ **M7**

- 2.1.1.1. Make a minimum of six brake applications at spaced increments of pedal effort or line pressure up to wheel lock or, alternatively, up to a mean fully developed deceleration of  $6 \text{ m/s}^2$  or up to the allowed maximum pedal force for the category of vehicle in question from an initial speed as given in the table below:

Vehicle category	Test speed in km/h	
	front axle	rear axle
M <sub>1</sub>	70	45
M <sub>2</sub>	50	40
N <sub>1</sub>	65	50

The initial brake temperature at the start of each application shall be  $\leq 100 \text{ }^\circ\text{C}$ .

- 2.1.1.2. Note and plot pedal force or line pressure and mean fully developed deceleration for each application, and determine the pedal force or line pressure required to achieve (if possible) a mean fully developed deceleration of  $5 \text{ m/s}^2$  for front axle brakes and  $3 \text{ m/s}^2$  for rear axle brakes. If these values cannot be achieved with the maximum allowed pedal force determine alternatively the pedal force or line pressure required to achieve maximum deceleration.
- 2.1.1.3. The replacement brake lining assembly shall be considered to show similar performance characteristics to the original brake lining assembly if the achieved mean fully developed decelerations at the same control force or line pressure in the upper two thirds of the generated curve are within 15 % of these obtained with the original brake lining assembly.

## 2.1.2. Speed sensitivity test

- 2.1.2.1. Using the pedal force derived from item 2.1.1.2 of this Appendix and with initial brake temperature  $\leq 100 \text{ }^\circ\text{C}$ , make three brake applications from each of the following speeds:

Front axle 65 km/h, 100 km/h and 135 km/h where  $v_{\text{max}}$  exceeds 150 km/h.

Rear axle 45 km/h, 65 km/h and 90 km/h where  $v_{\text{max}}$  exceeds 150 km/h.

- 2.1.2.2. Average the results for each group of three applications and plot speed against corresponding mean fully developed deceleration.
- 2.1.2.3. Mean fully developed decelerations recorded for the higher speeds shall lie within 15 % of those recorded for the lowest speed.

## 2.2. Inertia dynamometer test

### 2.2.1. Test equipment

For the tests an inertia dynamometer shall be equipped with the vehicle brake in question. The dynamometer shall be instrumented for continuous recording of rotational speed, brake torque, pressure in the brake line, number of rotations after brake application, braking time and brake rotor temperature.

### 2.2.2. Test conditions

- 2.2.2.1. The rotational mass of the dynamometer shall correspond to half the axle portion of the maximum vehicle mass as listed in the table below and to the rolling radius of the largest tyre that is authorised for that vehicle type(s).

Vehicle category	Axle portion of maximum vehicle mass	
	front	rear
M <sub>1</sub>	0,77	0,32
M <sub>2</sub>	0,69	0,44
N <sub>1</sub>	0,66	0,39

▼ M7

- 2.2.2.2. The initial dynamometer rotational speed shall correspond to the linear vehicle speed as stated in points 2.2.3 and 2.2.4 of this Appendix and shall be based on the dynamic rolling radius of the tyre.
- 2.2.2.3. Brake linings submitted for test shall be fitted to the relevant brakes and, until a fixed burnishing procedure is established, shall be burnished to the manufacturer's instructions in agreement with the technical service.
- 2.2.2.4. If cooling air is used, the speed of the airflow at the brake must not be higher than 10 km/h.
- 2.2.3. Cold performance equivalence test
- A comparison of the cold performance of the replacement brake lining assembly and the original brake lining assembly shall be made by comparing the results of testing to the following method.
- 2.2.3.1. From the initial speed of 80 km/h for M<sub>1</sub> and N<sub>1</sub> and 60 km/h for M<sub>2</sub> and with brake temperature ≤ 100 °C at the start of each application make a minimum of six brake applications at spaced intervals of line pressure up to a mean fully developed deceleration of 6 m/s<sup>2</sup>.
- 2.2.3.2. Note and plot line pressure and mean fully developed deceleration for each application, and determine line pressure required to achieve 5 m/s<sup>2</sup>.
- 2.2.3.3. The replacement brake lining assembly shall be considered to show similar performance characteristics to the original brake lining assembly if the achieved mean fully developed decelerations at the same control force or line pressure in the upper two thirds of the generated curve are within 15 % of those obtained with original brake lining assembly.
- 2.2.4. Speed sensitivity test
- 2.2.4.1. Using the line pressure derived from point 2.2.3.2. and with initial brake temperature ≤ 100 °C make three brake applications from rotational speeds corresponding to vehicle linear speeds of:  
75 km/h, 120 km/h and 160 km/h where v<sub>max</sub> exceeds 150 km/h
- 2.2.4.2. Average the results for each group of three applications and plot speed against corresponding mean fully developed deceleration.
- 2.2.4.3. Mean fully developed decelerations recorded for the higher speeds shall lie within 15 % of that recorded for the lowest speed.

## ▼M7

## Appendix 3

**Requirements for replacement brake lining assemblies for vehicles of categories O<sub>1</sub> and O<sub>2</sub>**

## 1. GENERAL

The test method described in this Appendix is based on an inertia dynamometer test. Alternatively the tests may be carried out on a test vehicle or on a rolling road test bench provided that the same test conditions are achieved and the same parameters measured as in the inertia dynamometer test.

## 2. TEST EQUIPMENT

For the tests an inertia dynamometer shall be equipped with the vehicle brake in question. The dynamometer shall be instrumented for continuous recording of rotational speed, brake torque, pressure in the brake line or actuation force, number of rotations after brake application, braking time and brake rotor temperature.

2.1. *Test conditions*

2.1.1. The rotational mass of the dynamometer shall correspond to half the relevant axle portion of the maximum vehicle mass and the rolling radius of the largest tyre that is authorised for that vehicle type(s).

2.1.2. The initial dynamometer rotational speed shall correspond to the linear vehicle speed as stated in point 3.1. of this Appendix and shall be based on the dynamic rolling radius of the smallest tyre that is authorised for that vehicle(s).

2.1.3. Brake lining assemblies submitted for the test shall be fitted to the relevant brake and, until a fixed burnishing procedure is established, shall be burnished to the manufacturer's instruction in agreement with the technical service.

2.1.4. If cooling air is used the speed of the airflow at the brake must not be higher than 10 km/h.

2.1.5. The actuation device fitted to the brake must correspond to the vehicle installation.

## 3. TESTS AND REQUIREMENTS

3.1. *Test 0 test*

From the initial speed of 60 km/h with a brake temperature  $\leq 100$  °C at the start of each application make a minimum of six consecutive brake applications at spaced intervals of line pressure or application force up to the maximum line pressure or up to 6 m/s<sup>2</sup> deceleration. Repeat the last brake application using an initial speed of 40 km/h.

3.2. *Type I test*

## 3.2.1. Heating procedure

The brake shall be heated with continuous braking according to the requirement of Annex II, point 1.3.2. starting with a brake rotor temperature  $\leq 100$  °C.

## 3.2.2. Hot performance

On completion of the heating procedure the hot performance from an initial speed of 40 km/h shall be measured under the conditions of point 3.1 above using the same line pressure or application force (the temperature conditions may be different). The mean fully developed deceleration with the heated brake must not be less than 60 % of the value achieved with the cold brake or 3,5 m/s<sup>2</sup>.

3.3. *Cold performance equivalence test*

A comparison of the cold performance of the replacement brake lining assembly and the original brake lining assembly shall be made by comparing the results of the Type 0 test as described in point 3.1.

**▼M7**

- 3.3.1. The Type 0 test as prescribed in point 3.1. shall be performed with one set of the original brake lining assembly.
- 3.3.2. The replacement brake lining assembly shall be considered to show similar performance characteristics to the original brake lining assembly if the achieved mean fully developed declarations at the same line pressure or application force in the upper two thirds of the generated curve within 15 % of those obtained with the original brake lining assembly.

▼ M7*Appendix 4***Determination of friction behaviour by machine testing**

1. INTRODUCTION
  - 1.1. Samples of a replacement brake lining assembly type shall be tested on a machine capable of generating the test conditions and applying the test procedures described in this Appendix.
  - 1.2. Test results shall be evaluated to determine sample friction behaviour.
  - 1.3. The friction behaviour of samples shall be compared to assess conformity with the standard registered for a replacement brake lining assembly type.
2. EQUIPMENT
  - 2.1. The machine shall be designed to accept and operate a full size brake similar to those fitted to the vehicle axle used for approval testing to point 5 of this Annex.
  - 2.2. The disc or drum rotational speed shall be  $660 \pm 10 \text{ min}^{-1}$  without load and shall not fall below  $600 \text{ min}^{-1}$  on full load.
  - 2.3. The test cycles and brake applications during the cycles shall be adjustable and automatic.
  - 2.4. Output torque or brake pressure (constant torque method) and working surface temperature shall be recorded.
  - 2.5. Provisions shall be made to direct cooling air across the brake at a rate of  $600 \pm 60 \text{ m}^3/\text{h}$ .
3. TEST PROCEDURE
  - 3.1. *Sample preparation*

The manufacturer's bedding schedule shall ensure a minimum of 80 % surface contact area for pad assemblies without exceeding a surface temperature of  $300 \text{ }^\circ\text{C}$  and 70 % surface contact area for the leading shoe assemblies without exceeding a surface temperature of  $200 \text{ }^\circ\text{C}$ .
  - 3.2. *Test schedule*

The test schedule comprises a number of consecutive braking cycles each containing  $\chi$  braking intervals of 5 seconds brake applied followed by 10 seconds brake released.

The following two methods may be used alternatively:

    - 3.2.1. Test schedule with constant pressure
      - 3.2.1.1. Pad assemblies
 

The hydraulic pressure  $p$  under the piston(s) of the calliper shall be constant following the formula:

$$p = \frac{M_d}{0,57 \times r_w \times A_k}$$

$M_d = 150 \text{ Nm}$  for  $A_k \leq 18,1 \text{ cm}^2$

$M_d = 300 \text{ Nm}$  for  $A_k > 18,1 \text{ cm}^2$

$A_k$  = area of calliper piston(s)

$r_w$  = effective radius of disc

▼ **M7**

No of cycle	Number of brake applications $\chi$	Initial brake rotor temperature (°C) $y$	Maximum brake rotor temperature (°C)	Forced cooling
1	1 × 10	≤ 60	open	no
2-6	5 × 10	100	open (350)	no
7	1 × 10	100	open	yes

## 3.2.1.2 Shoe assemblies

The mean contact pressure at the brake lining working surface shall be constant at  $22 \pm 6$  N/cm<sup>2</sup> calculated for a static brake without self-energising.

No of cycle	Number of brake applications $\chi$	Initial brake rotor temperature (°C)	Maximum brake rotor temperature (°C)	Forced cooling
1	1 × 10	≤ 60	200	yes
2	1 × 10	100	open	no
3	1 × 10	100	200	yes
4	1 × 10	100	open	no

## 3.2.2. Test schedule with constant torque

This method applies only for pad assemblies. The brake torque shall be constant within a tolerance of  $\pm 5$  % and adjusted to guarantee the maximum brake rotor temperatures given in the table below.

No of cycle	Number of brake applications $\chi$	Initial brake rotor temperature (°C) $y$	Maximum brake rotor temperature (°C)	Forced cooling
1	1 × 5	≤ 60	300-350	no
2-4	3 × 5	100	300-350	no
5	1 × 10	100	500-600	no
6-9	4 × 5	100	300-350	no
10	1 × 10	100	500-600	no
11-13	3 × 5	100	300-350	no
14	1 × 5	≤ 60	300-350	no

## 3.3. Evaluation of test results

Friction behaviour is determined from the brake torque noted at selected points in a test schedule. Where brake factor is constant, e.g. a disc brake, brake torque may be translated to coefficient of friction.

## 3.3.1. Pad assemblies

3.3.1.1. The operational coefficient of friction ( $\mu_{op}$ ) is the mean of the values recorded during cycles two to seven (constant pressure method) or during cycles 2-4, 6-9 and 11-13 (constant torque method); measurement being made one second after commencing the first brake application of each cycle.

3.3.1.2. The maximum coefficient of friction ( $\mu_{max}$ ) is the lowest value recorded during all cycles.

3.3.1.3. The minimum coefficient of friction ( $\mu_{min}$ ) is the lowest value recorded during all cycles.

## 3.3.2. Shoe assemblies

3.3.2.1. The mean torque ( $M_{mean}$ ) is the average of the maximum and minimum values of brake torque recorded during the fifth brake application of cycles one and three.

**▼M7**

- 3.3.2.2. The hot torque ( $M_{\text{hot}}$ ) is the minimum brake torque developed during cycles two and four. If the temperature exceeds 300 °C during these cycles the value at 300 °C is to be taken as  $M_{\text{hot}}$ .
- 3.4. *Acceptance criteria*
- 3.4.1. With each application for approval of a brake lining assembly type there shall be submitted:
- 3.4.1.1. for pad assemblies, values for ( $\mu_{\text{op}}$ ), ( $\mu_{\text{min}}$ ) en ( $\mu_{\text{max}}$ )
- 3.4.1.2. for shoe assemblies, values for  $M_{\text{mean}}$  and  $M_{\text{hot}}$ .
- 3.4.2. During production of an approved brake lining assembly type, test samples must demonstrate compliance with the values registered under point 3.4.1. of this Appendix with the following tolerances:
- 3.4.2.1. for disc brake pads:
- $\mu_{\text{op}} \pm 15\%$  of registered value
- $\mu_{\text{min}} \geq$  registered value
- $\mu_{\text{max}} \leq$  registered value
- 3.4.2.2. for simplex drum brake linings:
- $M_{\text{mean}} \pm 20\%$  of registered value
- $M_{\text{hot}} \geq$  registered value.

▼M7

## ANNEX XVI

## MODEL

*(maximum format: A4 (210 × 297 mm))*

## EC TYPE-APPROVAL CERTIFICATE

Stamp of administration

Communication concerning the:

- type-approval <sup>(1)</sup>
- extension of type-approval <sup>(1)</sup>
- refusal of type-approval <sup>(1)</sup>
- withdrawal of type-approval <sup>(1)</sup>

of a type of vehicle/component/separate technical unit <sup>(1)</sup> with regard to Directive 71/320/EC as last amended by Directive 98/12/EC.

EC type-approval number: .....

Reason for extension: .....

## SECTION I

1. Make (trade name of manufacturer):
2. Type and general commercial description:
3. Means of identification of type if marked on the vehicle component/separate technical unit <sup>(1)</sup> <sup>(2)</sup>:
- 3.1. Location of that marking:
4. Category of vehicle <sup>(1)</sup> <sup>(3)</sup>:
5. Name and address of manufacturer:
6. In the case of components and separate technical units, location and method of affixing of the EC approval mark:
7. Address(es) of assembly plant(s):

## SECTION II

1. Additional information (where applicable): See Addendum
2. Technical service responsible for carrying out the tests:
3. Date of test report:
4. Number of test report:
5. Remarks (if any): See Addendum
6. Place:
7. Date:
8. Signature:
9. The index to the information package lodged with the approval authority, which may be obtained on request, is attached.

<sup>(1)</sup> Delete where inapplicable.<sup>(2)</sup> If the means of identification of type contains characters not relevant to describe the vehicle component or separate technical unit types covered by this type-approval certificate such characters shall be represented in the documentation by the symbol: '?' (e.g. ABC?123?).<sup>(3)</sup> As defined in Annex II (A) to Directive 70/156/EEC.



▼ M7

*Addendum*

to EC type-approval certificate No . . . concerning the separate technical unit type approval of a brake lining assembly with regard to Directive 71/320/EEC as last amended by Directive 98/12/EC

1. Additional information

1.1. Make and type of brake lining assembly:

1.2. Make and type of brake lining:

1.3. Vehicles/axles/brakes for which brake lining assembly type qualifies as original brake lining assembly:

.....  
.....

1.4. Vehicles/axles/brakes for which brake lining assembly type qualifies as replacement brake lining assembly:

.....  
.....

5. Remarks: .....

▼ **M7***ANNEX XVII***INFORMATION DOCUMENT No ...****relating to EC type-approval of brake lining assemblies.***(Directive 71/320/EEC as last amended by Directive 98/12/EC)*

The following information, if applicable, shall be supplied in triplicate and include a list of contents. Any drawings shall be supplied in appropriate scale and in sufficient detail on size A4 format. Photographs, if any, shall show sufficient detail.

If the systems, components or separate technical units have electronic controls, information concerning their performance shall be supplied.

- 0. GENERAL
  - 0.1. Make (trade name of manufacturer): .....
  - 0.2. Type: .....
  - 0.5. Name and address of manufacturer: .....
  - 0.7. In the case of components and separate technical units, location and method of affixing the EC approval mark: .....
  - 0.8. Address(es) of assembly plant(s): .....
- 1. DESCRIPTION OF THE DEVICE
  - 1.1. Make and type of brake lining assembly:
  - 1.2. Make and type of brake lining:
  - 1.3. Vehicle(s)/axle(s)/brake(s) for which the brake lining assembly qualifies as original brake lining assembly: .....
  - 1.4. Vehicle(s)/axle(s)/brake(s) for which the brake lining assembly is intended to qualify as replacement brake lining assembly: .....
  - 1.5. Drawings(s) of the brake lining assembly showing functional dimensions: .....
  - 1.6. Indication of positions on the vehicle(s)/axle(s)/brake(s) for which approval is sought: .....
  - 1.7. Values for friction behaviour (see point 3.4.1 of Appendix 4 to Annex XV): .....

## ▼M7

## ANNEX XVIII

## INFORMATION DOCUMENT No ...

**pursuant to Annex I of Council Directive 70/156/EEC (\*) relating to EC type-approval of a vehicle with respect to the braking equipment of motor vehicles***(Directive 71/320/EEC as last amended by Directive 98/12/EC).*

The following information, if applicable, shall be supplied in triplicate and include a list of contents. Any drawings shall be supplied in appropriate scale and in sufficient detail on size A4 format. Photographs, if any, shall show sufficient detail.

If the systems, components or separate technical units have electronic controls, information concerning their performance shall be supplied.

- 0. GENERAL
  - 0.1. Make (trade name of manufacturer):
  - 0.2. Type:
  - 0.3. Means of identification of type, if marked on the vehicle <sup>(b)</sup>:
    - 0.3.1. Location of that marking:
  - 0.4. Category of vehicle <sup>(c)</sup>:
  - 0.5. Name and address of manufacturer:
  - 0.8. Address(es) of assembly plant(s):
- 1. GENERAL CONSTRUCTION CHARACTERISTICS OF THE VEHICLE.
  - 1.1. Photographs and/or drawings of a representative vehicle:
  - 1.3. Number of axles and wheels:
    - 1.3.1. Number and position of axles with double wheels:
    - 1.3.3. Powered axles (number, position, interconnection):
  - 1.8. Hand of drive: left/right <sup>(1)</sup>
- 2. MASSES AND DIMENSIONS <sup>(e)</sup> (in kg and mm) (Refer to drawing where applicable)
  - 2.1. Wheelbase(s) (fully loaded) <sup>(f)</sup>:
  - 2.3.1. Track of each steered axle <sup>(i)</sup>:
  - 2.6. Mass of the vehicle with bodywork, and with coupling device in the case of a towing vehicle of category other than M<sub>1</sub> in running order, or mass of the chassis with cab if the manufacturer does not fit the bodywork and/or coupling device (including coolant, oils, fuel, 100 % other liquids except used waters, tools, spare wheel and driver and, for buses and coaches, the mass of the crew member (75 kg) if there is a crew seat in the vehicle): (maximum and minimum):...
    - 2.6.1. Distribution of this mass among the axles and, in the case of a semi-trailer or centre-axle trailer, load on the coupling point: (maximum and minimum):...
  - 2.7. Minimum mass of the completed vehicle as stated by the manufacturer, in the case if an incomplete vehicle:
    - 2.7.1. Distribution of this mass among the axles and, in the case of semi-trailer or centre-axle trailer, load on the coupling point:
  - 2.8. Technically permissible maximum laden mass stated by the manufacturer (maximum and minimum <sup>(g)</sup>):

(\*) The point numbers and footnotes used in this information document correspond to those set out in Annex I to Directive 70/156/EEC. Points not relevant for the purpose of this Directive are omitted.

▼ **M7**

- 2.8.1. Distribution of this mass among the axles and, in the case of semi-trailer or centre-axle trailer, load on the coupling point (maximum and minimum):
- 2.9. Technically permissible maximum load/mass on each axle:
- 2.10. Technically permissible maximum/mass on each axle group:
- 2.11. Technically permissible maximum towable mass of the motor vehicle in the case of:
  - 2.11.1. Full trailer:
  - 2.11.2. Semi-trailer:
  - 2.11.3. Centre-axle trailer:
    - 2.11.3.1. Maximum ratio of the coupling overhang <sup>(p)</sup> to the wheelbase:
  - 2.11.4. Technically permissible maximum mass of the combination:
  - 2.11.6. Maximum mass of unbraked trailer:
- 2.12. Technically permissible maximum static vertical load/mass on the vehicle's coupling point:
  - 2.12.1 of the motor vehicle:
- 3. POWER PLANT <sup>(q)</sup>
  - 3.1. Manufacturer:
    - 3.1.1. Manufacturer's engine code (as marked on the engine, or other means of identification):
  - 3.2. Internal combustion engine
    - 3.2.1.1. Working principle: positive ignition/compression ignition, four stroke/two stroke <sup>(l)</sup>:
    - 3.2.1.9. Maximum permitted engine speed as prescribed by the manufacturer: ... min<sup>-1</sup>
  - 3.2.5. Electrical system
    - 3.2.5.1. Rated voltage: ... V positive/negative ground <sup>(l)</sup>
    - 3.2.5.2. Generator:
      - 3.2.5.2.1. Type:
      - 3.2.5.2.2. Nominal output: ... VA
  - 3.3. Electric motor
    - 3.3.1. Type (winding, excitation):
      - 3.3.1.1. Maximum hourly output: ... kW
      - 3.3.1.2. Operating voltage: ... V
    - 3.3.2. Battery
      - 3.3.2.2. Mass: ... kg
  - 3.4. Other engines or motors or combinations thereof (particulars regarding the parts of such engines or motors):
- 4. TRANSMISSION
  - 4.1. Drawing of the transmission (\*\*):
  - 4.2. Type (mechanical, hydraulic, electric, etc.):

(\*\*) If necessary for the explanation of point 8.

## ▼M7

## 4.6. Gear ratios

Gear	Internal gearbox ratios (ratios of engine to gearbox output shaft revolutions)	Final drive ratio(s) (ratio of gearbox output shaft to driven wheel revolutions)	Total gear ratios
Maximum for CVT <sup>(1)</sup>			
1			
2			
3			
...			
Minimum for CVT <sup>(1)</sup>			
Reverse			

<sup>(1)</sup> Continuously variable transmission.

- 4.7. Maximum vehicle speed (in km/h) <sup>(w)</sup>:
5. AXLES
- 5.4. Position of retractable axle(s):
6. SUSPENSION
- 6.1. Drawing of the suspension arrangements (\*\*):
- 6.2. Type and design of the suspension of each axle or group of axles or wheel:
- 6.6. Tyres and wheels
- 6.6.1. Tyre/wheel combination(s) (for tyres indicate size designation, minimum load-capacity index, minimum speed category symbol; for wheels indicate rim size(s) and off-set(s))
- 6.6.1.1. AXLES
- 6.6.1.1.1. Axle 1:
- 6.6.1.1.2. Axle 2:
- 6.6.1.1.3. Axle 3:
- 6.6.1.1.4. Axle 4:
- etc.
- 6.6.2. Upper and lower limit of rolling radii:
- 6.6.2.1. Axle 1:
- 6.6.2.2. Axle 2:
- 6.6.2.3. Axle 3:
- 6.6.2.4. Axle 4:
- etc.
- 6.6.3. Tyre pressure(s) as recommended by the vehicle manufacturer:  
...kPa
- 6.6.5. Brief description of temporary-use spare unit, if any:
8. BRAKES
- The following particulars, including means of identification, where applicable, are to be given:
- 8.1. Type and characteristics of the brakes (as defined in Annex I, point 1.6 to Directive 71/320/EEC) with a drawing, (e.g. drums or discs, wheels braked, connection to braked wheels, make and type of shoe/pad assemblies and/or linings, effective braking areas,

(\*\*) If necessary for the explanation of point 8.

▼ M7

- radius of drums, shoes or discs, mass of drums, adjustment devices relevant parts of the axle(s) and suspension, etc.
- 8.2. Operating diagram, description and/or drawing of the following braking systems (as defined in Annex I, point 1.2 to Directive 71/320/EEC) with e.g. transmission and control (construction, adjustment, lever ratios, accessibility of control and its position, ratchet controls in the case of mechanical transmission, characteristics of the main parts of the linkage, cylinders and control pistons, brake cylinders or equivalent components in the case of electrical braking systems).
- 8.2.1. Service braking system:
- 8.2.2. Secondary braking system:
- 8.2.3. Parking braking system:
- 8.2.4. Any additional braking system:
- 8.3. Control and transmission of trailer braking systems in vehicles designed to tow a trailer:
- 8.4. Vehicle is equipped to tow a trailer with electric/pneumatic/hydraulic <sup>(1)</sup> service brakes: yes/no <sup>(1)</sup>
- 8.5. Anti-lock braking system: Yes/No/Optional <sup>(1)</sup>
- 8.5.1. For vehicles with anti-lock braking systems, description of system operation (including any electronic parts), electric block diagram, hydraulic or pneumatic circuit plan:
- 8.6. Calculation and curves according to the Appendix to point 1.1.4.2. of Annex II to Directive 71/320/EEC (or the Appendix to Annex XI, if applicable):
- 8.7. Description and/or drawing of the energy supply (also to be specified for power-assisted braking systems):
- 8.7.1. In the case of compressed air systems, working pressure  $p_2$  in the pressure reservoir(s):
- 8.7.2. In the case of vacuum braking systems, the initial energy level in the reservoir(s):
- 8.8. Calculation of the braking system; determination of the ratio between the total braking forces at the circumference of the wheels and the force applied to the braking control:
- 8.9. Brief description of the braking systems (according to point 1.6. of Annex IX, Appendix 1 to Directive 71/320/EEC):
- 8.10. If claiming exemptions from the Type I and/or Type II or Type III tests, state the number of the report in accordance with Appendix 2 of Annex VII to Directive 71/320/EEC:

Date: ..... File: .....

▼ M7

## ANNEX XIX

## INFORMATION DOCUMENT No ...

**pursuant to Annex I of Council Directive 70/156/EEC (\*) relating to EC type-approval of a vehicle with respect to the braking equipment of trailers with other than inertia (overrun) brakes***(Directive 71/320/EEC as last amended by Directive 98/12/EC).*

The following information, if applicable, shall be supplied in triplicate and include a list of contents. Any drawings shall be supplied in appropriate scale and in sufficient detail on size A4 format. Photographs, if any, shall show sufficient detail.

If the systems, components or separate technical units have electronic controls, information concerning their performance shall be supplied.

- 0. GENERAL
  - 0.1. Make (trade name of manufacturer):
  - 0.2. Type:
  - 0.3. Means of identification of type, if marked on the vehicle <sup>(b)</sup>:
    - 0.3.1. Location of that marking:
  - 0.4. Category of vehicle <sup>(c)</sup>:
  - 0.5. Name and address of manufacturer:
  - 0.8. Address(es) of assembly plant(s):
- 1. GENERAL CONSTRUCTION CHARACTERISTICS OF THE VEHICLE
  - 1.1. Photographs and/or drawings of a representative vehicle:
  - 1.3. Number of axles and wheels:
    - 1.3.1. Number and position of axles with double wheels:
  - 2. MASSES AND DIMENSIONS <sup>(e)</sup> (in kg and mm) (Refer to drawing where applicable)
    - 2.1. Wheelbase(s) (fully loaded) <sup>(f)</sup>:
    - 2.3.1. Track of each steered axle <sup>(g)</sup>:
    - 2.6. Mass of the vehicle with bodywork, and with coupling device in the case of a towing vehicle of category other than M<sub>1</sub> in running order, or mass of the chassis with cab if the manufacturer does not fit the bodywork and/or coupling device (including coolant, oils, fuel, 100 % other liquids except used waters, tools, spare wheel and driver and, for buses and coaches, the mass of the crew member (75 kg) if there is a crew seat in the vehicle) (maximum and minimum): ...
      - 2.6.1. Distribution of this mass among the axles and, in the case of a semi-trailer or centre-axle trailer, load on the coupling point (maximum and minimum): ...
    - 2.7. Minimum mass of the completed vehicle as stated by the manufacturer, in the case if an incomplete vehicle:
      - 2.7.1. Distribution of this mass among the axles and, in the case of semi-trailer or centre-axle trailer, load on the coupling point:
    - 2.8. Technically permissible maximum laden mass stated by the manufacturer <sup>(h)</sup>(maximum and minimum):
      - 2.8.1. Distribution of this mass among the axles and, in the case of semi-trailer or centre-axle trailer, load on the coupling point (maximum and minimum):
    - 2.9. Technically permissible maximum load/mass on each axle:

(\*) The point numbers and footnotes used in this information document correspond to those set out in Annex I to Directive 70/156/EEC. Points not relevant for the purpose of this Directive are omitted.

▼ **M7**

- 2.10. Technically permissible maximum load/mass on each axle group:
- 2.12. Technically permissible maximum static vertical load/mass on the vehicle's coupling point:
  - 2.12.2 of the semi-trailer or centre-axle trailer:
- 5. AXLES
- 5.4. Position of retractable axle(s):
- 6. SUSPENSION
- 6.1. Drawing of the suspension arrangements (\*\*):
- 6.2. Type and design of the suspension of each axle or group of axles or wheel:
  - 6.6. Tyres and wheels
    - 6.6.1. Tyre/wheel combination(s) (for tyres indicate size designation, minimum load-capacity index, minimum speed category symbol; for wheels indicate rim size(s) and off-set(s))
      - 6.6.1.1. AXLES
        - 6.6.1.1.1. Axle 1:
        - 6.6.1.1.2. Axle 2:
        - 6.6.1.1.3. Axle 3:
        - 6.6.1.1.4. Axle 4:
        - etc.
      - 6.6.2. Upper and lower limit or rolling radii:
        - 6.6.2.1. Axle 1:
        - 6.6.2.2. Axle 2:
        - 6.6.2.3. Axle 3:
        - 6.6.2.4. Axle 4:
        - etc.
      - 6.6.3. Tyre pressure(s) as recommended by the vehicle manufacturer: ... kPa
- 8. BRAKES
 

The following particulars, including means of identification, where applicable, are to be given:

  - 8.1. Type and characteristics of the brakes (as defined in Annex I, point 1.6, to Directive 71/320/EEC) with a drawing, (e.g. drums or discs, wheels braked, connection to braked wheels, make and type of shoe/pad assemblies and/or linings, effective braking areas, radius of drums, shoes or discs, mass of drums, adjustment devices relevant parts of the axle(s) and suspension, etc.):
  - 8.2. Operating diagram, description and/or drawing of the following braking systems (as defined in Annex I, point 1.2, to Directive 71/320/EEC) with e.g. transmission and control (construction, adjustment, lever ratios, accessibility of control and its position, ratchet controls in the case of mechanical transmission, characteristics of the main parts of the linkage, cylinders and control pistons, brake cylinders or equivalent components in the case of electrical braking systems).
    - 8.2.1. Service braking system:
    - 8.2.3. Parking braking system:
    - 8.2.4. Any additional braking system:
    - 8.2.5. Break-away braking system
  - 8.5. Anti-lock braking system: Yes/No/Optional <sup>(1)</sup>

(\*\*) If necessary for the explanation of point 8.



**▼M7**

- 8.5.1 For vehicles with anti-lock braking systems, description of system operation (including any electronic parts), electric block diagram, hydraulic or pneumatic circuit plan:
- 8.6. Calculation and curves according to the Appendix to point 1.1.4.2. of Annex II to Directive 71/320/EEC (or the Appendix to Annex XI, if applicable):
- 8.7. Description and/or drawing of the energy supply (also to be specified for power-assisted braking system):
  - 8.7.1. In the case of compressed air braking systems, working pressure  $p_2$  in the pressure reservoir(s):
  - 8.7.2. In the case of vacuum braking systems, the initial energy level in the reservoir(s):
- 8.8. Calculation of the braking system; determination of the ratio between the total braking forces at the circumference of the wheels and the force applied to the braking control:
- 8.9. Brief description of the braking systems (according to point 1.6. of Annex IX, Appendix 1 to Directive 71/320/EEC):
- 8.10. If claiming exemptions from the Type I and/or Type II or Type III tests, state the number of the report in accordance with Appendix 2 of Annex VII to Directive 71/320/EEC:

Date: ..... File: .....