

This document is meant purely as a documentation tool and the institutions do not assume any liability for its contents

► **B**

COUNCIL DIRECTIVE

of 1 March 1971

on the approximation of the laws of the Member States relating to the rear-view mirrors of motor vehicles

(71/127/EEC)

(OJ L 68, 22.3.1971, p. 1)

Amended by:

	Official Journal		
	No	page	date
► <u>M1</u> Commission Directive 79/795/EEC of 20 July 1979	L 239	1	22.9.1979

Amended by:

► <u>A1</u> Act of Accession of Denmark, Ireland and the United Kingdom of Great Britain and Northern Ireland	L 73	14	27.3.1972
(adapted by Council Decision of 1 January 1973)	L 2	1	1.1.1973

Corrected by:

- **C1** Consolidated text of corrigenda to instruments published in Special Editions 1952-72, p. 85 (71/127/EEC)

▼B**COUNCIL DIRECTIVE****of 1 March 1971****on the approximation of the laws of the Member States relating to
the rear-view mirrors of motor vehicles**

(71/127/EEC)

THE COUNCIL OF THE EUROPEAN COMMUNITIES,

Having regard to the Treaty establishing the European Economic Community, and in particular Article 100 thereof;

Having regard to the proposal from the Commission;

Having regard to the Opinion of the European Parliament⁽¹⁾;Having regard to the Opinion of the Economic and Social Committee⁽²⁾;Whereas the technical requirements which motor vehicles must satisfy pursuant to national laws relate, *inter alia*, to their rear-view mirrors;Whereas those requirements differ from one Member State to another; whereas it is therefore necessary that all Member States adopt the same requirements either in addition to or in place of their existing requirements, in order, in particular, to allow the EEC type-approval procedure which was the subject of the Council Directive of 6 February 1970⁽³⁾ on the approximation of the laws of the Member States relating to the type-approval of motor vehicles and their trailers to be applied in respect of each type of vehicle;

Whereas rules on rear-view mirrors should lay down requirements concerning not only how such mirrors should be fitted on vehicles but also their construction;

Whereas a harmonised type-approval procedure for rear-view mirrors makes it possible for each Member State to check compliance with the common construction and testing requirements and to inform the other Member States of its findings by sending a copy of the type-approval certificate completed for each type of rear-view mirror; whereas the placing of an EEC type-approval mark on all mirrors manufactured in conformity with the approved type obviates any need for technical checks on these mirrors in the other Member States;

HAS ADOPTED THIS DIRECTIVE:

Article 1

1. Each Member State shall approve any type of rear-view mirror which satisfies the construction and testing requirements laid down in item 2 of Annex I.

2. The Member State which has granted type approval shall take the measures required in order to verify, in so far as is necessary and if need be in co-operation with the competent authorities in the other Member States, that production models conform to the approved type. Such verification shall be limited to spot checks.

Article 2

Member States shall issue to the manufacturer, or to his authorised representative, an EEC type-approval mark which shall conform to the model shown in item 2.6 of Annex I, for each type of rear-view mirror which they approve pursuant to Article 1.

⁽¹⁾ OJ No C 160, 18.12.1969, p. 7.

⁽²⁾ OJ No C 48, 16.4.1969, p. 16.

⁽³⁾ OJ No L 42, 23.2.1970, p. 1.

▼B

Member States shall take all appropriate measures to prevent the use of marks liable to create confusion between rear-view mirrors which have been type-approved pursuant to Article 1 and other mirrors.

Article 3

1. No Member State may prohibit the placing on the market of rear-view mirrors on grounds relating to their construction or method of functioning if they bear the EEC type-approval mark.

2. Nevertheless, this provision shall not prevent a Member State from taking such measures in respect of rear-view mirrors bearing the EEC type-approval mark which, by their design, do not conform to the approved prototype.

That State shall inform the other Member States and the Commission forthwith of the measures taken, specifying the reasons for its decision. The provisions of Article 5 shall also apply.

▼M1

There shall be failure to conform to the approved type, within the meaning of the first subparagraph, where the requirements of item 2 of Annex I are not observed.

▼B*Article 4*

The competent authorities of each Member State shall within one month send to the competent authorities of the other Member States a copy of the type-approval certificates completed for each type of rear-view mirror which they approve or refuse to approve.

Article 5

1. If the Member State which has granted EEC type-approval finds that a number of rear-view mirrors bearing the same type-approval mark do not conform to the type which it has approved, it shall take the necessary measures to ensure that production models conform to the approved type. The competent authorities of that State shall advise those of the other Member States of the measures taken, which may, where necessary, extend to withdrawal of EEC type-approval. The said authorities shall take the same measures if they are informed by the competent authorities of another Member State of such failure to conform.

2. The competent authorities of Member States shall inform each other within one month of any withdrawal of EEC type-approval, and of the reasons for such measure.

3. If the Member State which has granted EEC type-approval disputes the failure to conform notified to it, the Member States concerned shall endeavour to settle the dispute. The Commission shall be kept informed and shall, where necessary, hold appropriate consultations for the purpose of reaching a settlement.

Article 6

All decisions taken pursuant to the provisions adopted in implementation of this Directive which refuse or withdraw type-approval for a rear-view mirror or prohibit its use shall set out in detail the reasons on which they are based. A decision shall be notified to the party concerned, who shall at the same time be informed of the remedies available to him under the laws in force in the Member States and of the time limits allowed for the exercise of such remedies.

▼B*Article 7***▼M1**

1. With effect from 1 February 1980, no Member State may, on grounds relating to rear-view mirrors:
 - (a) — refuse, in respect of a type of motor vehicle, to grant EEC type-approval, to issue the document referred to in the last indent of Article 10 (1) of Directive 70/156/EEC, or to grant national type-approval, or
 - prohibit the entry into service of the vehicles,
 if the rear-view mirrors of this type of vehicle or of these vehicles comply with the provisions of this Directive;
 - (b) — refuse, in respect of a type of rear-view mirror, to grant EEC component type-approval or national type-approval, if these rear-view mirrors comply with the provisions of this Directive, or
 - prohibit the placing on the market of rear-view mirrors which bear the EEC component type-approval mark laid down in this Directive.
2. With effect from 1 October 1981 a Member State:
 - (a) — shall not issue the document referred to in the last indent of Article 10 (1) of Directive 70/156/EEC in respect of a type of vehicle of which the rear-view mirrors do not comply with the provisions of this Directive,
 - may refuse to grant national type-approval in respect of a type of vehicle of which the rear-view mirrors do not comply with the provisions of this Directive;
 - (b) — shall not grant EEC component type-approval in respect of a type of rear-view mirror if the latter does not comply with the provisions of this Directive,
 - may refuse to grant national component type-approval in respect of a type of rear-view mirror if the latter does not comply with the provisions of this Directive.
3. With effect from 1 October 1984 Member States:
 - may prohibit the entry into service of vehicles of which the rear-view mirrors do not comply with the provisions of this Directive,
 - may prohibit the placing on the market of rear-view mirrors which do not bear the EEC component type-approval mark laid down in this Directive.

▼A1*Article 7a*

No Member State may refuse or prohibit the sale or registration, entry into service or use of a vehicle on grounds relating to its rear-view mirrors if these comply with the requirements laid down in the Annexes.

▼B*Article 8*

For the purposes of this Directive, 'vehicle' means any motor vehicle intended for use on the road, with or without bodywork, having at least four wheels and a maximum design speed exceeding 25 km/h, with the exception of vehicles which run on rails, agricultural tractors and machinery, and public works vehicles.

Article 9

The amendments necessary for adjusting the requirements of Annexes I, II and III so as to take account of technical progress shall be adopted in accordance with the procedure laid down in Article 13 of the Council Directive of 6 February 1970 on the approximation of the laws of the Member States relating to the type approval of motor vehicles and their trailers.

▼B

Article 10

1. Member States shall put into force provisions containing the requirements needed in order to comply with this Directive within eighteen months of its notification and shall forthwith inform the Commission thereof.
2. Member States shall ensure that the texts of the main provisions of national law which they adopt in the field governed by this Directive are communicated to the Commission.

Article 11

This Directive is addressed to the Member States.

▼ **M1**

ANNEX I

1. DEFINITIONS

- 1.1. 'Rear-view mirror' means any device intended to give, within the field of vision defined in item 3.4, a clear view to the rear, excluding complex optical systems such as periscopes.
- 1.2. 'Interior rear-view mirror' means a device as defined in item 1.1 which can be fitted in the passenger compartment of a vehicle.
- 1.3. 'Exterior rear-view mirror' means a device as defined in item 1.1 which can be mounted on the external surface of a vehicle.
- 1.4. 'Additional rear-view mirror' means a rear-view mirror other than a device of the type defined in item 1.1 which can be fitted to the inside or outside of the vehicle provided that it complies with the provisions of item 2 other than 2.1.1, 2.2 and 2.3.4.
- 1.5. 'Rear-view mirror type' means devices which do not differ in respect of the following essential characteristics:
- 1.5.1. the dimensions and radius of curvature of the rear-view mirror's reflecting surface:
- 1.5.2. the design, shape or materials of the rear-view mirrors, including the connection with the bodywork.
- 1.6. 'Class of rear-view mirrors' means all devices having one or more common characteristics or functions. Interior rear-view mirrors are grouped in Class I. Additional interior rear-view mirrors are grouped in Class Is.

Exterior rear-view mirrors are grouped in Classes II and III.

Additional exterior rear-view mirrors are grouped in Classes IIs and IIIs.

- 1.7. 'r' means the average of the radii of curvature measured over the reflecting surface, in accordance with the method described in item 2 of Appendix 1 to this Annex.
- 1.8. 'The principal radii of curvature at one point on the reflecting surface (r_p)' means the values obtained with the apparatus defined in Appendix 1, measured on the arc of the reflecting surface passing through the centre of the mirror parallel to the segment b, as defined in item 2.2.2.1, and on the arc perpendicular to this segment.
- 1.9. 'The radius of curvature at one point on the reflecting surface (r_p)' means the arithmetical average of the principal radii of curvature r_1 and r'_1 , i. e.:
- $$r_p = \frac{r_1 + r'_1}{2}$$
- 1.10. 'Centre of the mirror' means the centroid of the visible area of the reflecting surface.
- 1.11. 'The radius of curvature of the constituent parts of the rear-view mirror' means the radius 'c' of the arc of the circle which most closely approximates to the curved form of the part in question.
- 1.12. 'The driver's ocular points' means two points 65 mm apart and 635 mm vertically above point R of the driver's seat as defined in Annex IV. The straight line joining these points runs perpendicular to the vertical longitudinal median plane of the vehicle. The centre of the segment joining the two ocular points is in a vertical longitudinal plane which must pass through the centre of the driver's designated seating position, as specified by the vehicle manufacturer.
- 1.13. 'Ambinocular vision' means the total field of vision obtained by the superimposition of the monocular fields of the right eye and the left eye (see diagram below).

▼ M1

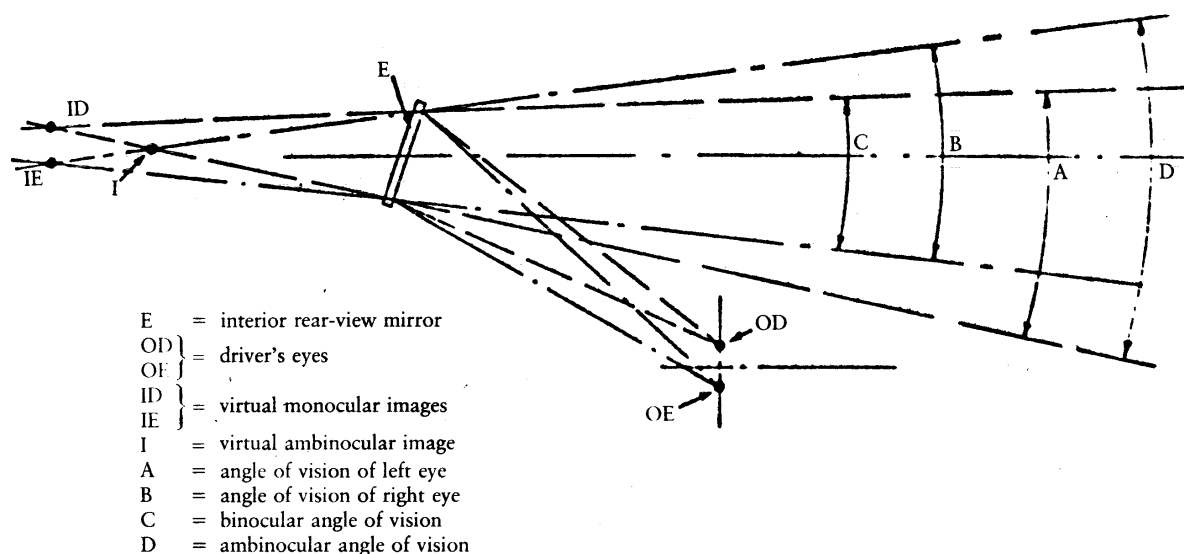

1.14. 'Type of vehicle as regards rear-view mirrors' means motor vehicles which are identical in respect of the following basic features:

- 1.14.1. the bodywork features which reduce the field of vision;
- 1.14.2. the coordinates of point R;
- 1.14.3. the prescribed positions and types of rear-view mirror.

1.15. 'Vehicles of categories M₁, M₂, M₃, N₁, N₂ and N₃' means those defined in Annex I to Directive 70/156/EEC.

2. PROVISIONS RELATING TO EEC COMPONENT TYPE-APPROVAL OF REAR-VIEW MIRRORS

2.1. General specifications

- 2.1.1. All rear-view mirrors must be adjustable.
- 2.1.2. The edge of the reflecting surface must be enclosed in a holder which, on its perimeter, must have a value 'c' ≥ 2.5 mm at all points and in all directions. If the reflecting surface projects beyond the holder, the radius of curvature 'c' on the edge of the projecting part must be not less than 2.5 mm and the reflecting surface must return into the holder under a force of 50 N applied to the point of greatest projection, relative to the holder, in a horizontal direction approximately parallel to the longitudinal median plane of the vehicle.
- 2.1.3. When the rear-view mirror is mounted on a plane surface, all parts, irrespective of the adjustment position of the device, including those parts remaining attached to the support after the test provided for in 2.4.2, which are in potential, static contact with a sphere either 165 mm in diameter in the case of an interior rear-view mirror or 100 mm in diameter in the case of an exterior rear-view mirror, must have a radius of curvature 'c' of not less than 2.5 mm.
 - 2.1.3.1. Edges of fixing holes or recesses of which the diameter or longest diagonal is less than 12 mm are exempt from the radius requirements of item 2.1.3 provided that they are blunted.
- 2.1.4. The attachment device on the vehicle must be so designed that a cylinder with a 50 mm radius, having as its axis the axis, or one of the axes, of pivot or rotation which ensure deflection of the rear-view mirror in the direction of impact concerned, passes through at least part of the surface to which the device is attached.
- 2.1.5. The parts of exterior rear-view mirrors referred to in items 2.1.2 and 2.1.3 which are made of a material with a Shore A hardness not exceeding 60 are exempt from the relevant provisions.
- 2.1.6. In the case of those parts of interior rear-view mirrors which are made of a material with a Shore A hardness of less than 50 and which are mounted on a rigid support, the requirements of items 2.1.2 and 2.1.3 shall only apply to the support.

▼ **M1****2.2. Dimensions****2.2.1. Interior rear-view mirrors (Class I)**

The dimensions of the reflecting surface must be such that it is possible to inscribe thereon a rectangle one side of which is 4 cm and the other 'a' cm in length, where

$$a = 15 \text{ cm} \times \frac{1}{1 + \frac{1000}{r}}$$

2.2.2. Exterior rear-view mirrors (classes II and III)

2.2.2.1. The dimensions of the reflecting surface must be such that it is possible to inscribe therein:

- a rectangle 4 cm high the base length of which, measured in centimetres, has the value 'a',
- a segment which is parallel to the height of the rectangle and the length of which, expressed in centimetres, has the value 'b'.

2.2.2.2. The minimum values of 'a' and 'b' are given in the table below:

Class of rear-view mirror	Categories of vehicles for which the rear-view mirrors are designed	a	b
II	M ₂ , M ₃ , N ₂ and N ₃	$\frac{17}{1 + \frac{1000}{r}}$	20
III	M ₁ and N ₁	$\frac{13}{1 + \frac{1000}{r}}$	7

2.3. Reflecting surface and coefficients of reflection

2.3.1. The reflecting surface of a rear-view mirror must be either flat or spherically convex.

2.3.2. Differences between the radii of curvature

2.3.2.1. The difference between r_i or r'_i and r_p at each reference point must not exceed 0.15 r.

2.3.2.2. The difference between any of the radii of curvature (r_{p1} , r_{p2} , and r_{p3}) and r must not exceed 0.15 r.

2.3.2.3. When r is not less than 3 000 mm, the value of 0.15 r quoted in items 2.3.2.1 and 2.3.2.2 is replaced by 0.25 r.

2.3.3. The value of 'r' must be not less than:

- 1 800 mm for Class II rear-view mirrors,
- 1 200 mm for Class I and III rear-view mirrors.

2.3.4. The value of the normal coefficient of reflection, as determined according to the method described in Appendix 2 to this Annex, must be not less than 40 %.

If the mirror has two positions ('day' and 'night'), the 'day' position must allow the colours of the signals used for road traffic to be recognized. The value of the normal coefficient of reflection in the 'night' position must be not less than 4 %.

2.3.5. The reflecting surface must retain the characteristics laid down in item 2.3.4 in spite of prolonged exposure to adverse weather conditions in normal use.

2.4. Tests

2.4.1. The reaction of rear-view mirrors to impact and bending on the holder fixed to the stem or support shall be tested in the manner described in items 2.4.2 and 2.4.3.

2.4.1.1. The test provided for in item 2.4.2 shall not be required in the case of any Class II or IIs exterior rear-view mirror of which no part is less than 2 m from the ground, regardless of the adjustment posi-

▼M1

tion, when the vehicle is under a load corresponding to its maximum technically permissible weight.

In such cases the manufacturer is required to provide a description stipulating that the rear-view mirror must be mounted in such a way that none of its parts, in any of the possible adjustment positions, is less than 2 m above the ground when the vehicle is under a load corresponding to its maximum technically permissible weight.

Where advantage is taken of this derogation, the arm shall be indelibly marked with the symbol \triangle 2m and the type-approval certificate shall be endorsed to this effect.

2.4.2. *Impact test*

2.4.2.1. Description of the test rig.

2.4.2.1.1. The test rig consists of a pendulum capable of swinging about two horizontal axes at right angles to each other, one of which is perpendicular to the plane containing the 'release' trajectory of the pendulum.

The end of the pendulum comprises a hammer formed by a rigid sphere with a diameter of 165 ± 1 mm and having a 5 mm-thick rubber covering of Shore hardness A 50.

A device is provided which permits determination of the maximum angle assumed by the arm in the plane of release.

A support firmly fixed to the structure of the pendulum serves to hold the specimens in compliance with the impact requirements specified in item 2.4.2.2.6.

Figure 1 below gives the dimensions of the test rig and the special design specifications.

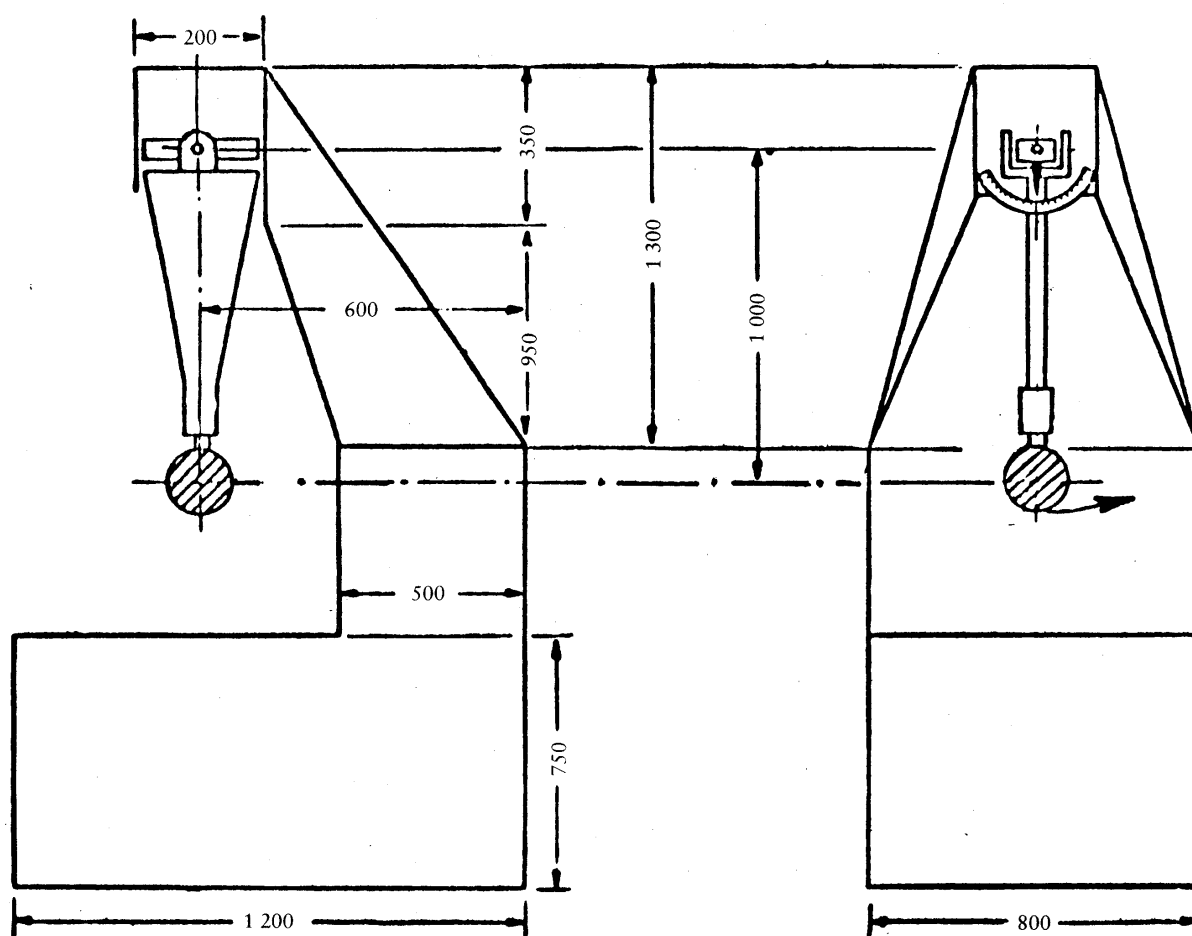

Figure 1

▼ **M1**

- 2.4.2.1.2. The centre of percussion of the pendulum coincides with the centre of the sphere which forms the hammer. It is at a distance 'l' from the axis of oscillation in the release plane which is equal to 1 ± 5 mm. The reduced mass of the pendulum is $m = 6.8 \pm 0.05$ kg (the relationship of 'm' to the total mass 'm' of the pendulum and to the distance 'd' between the centre of gravity of the pendulum and its axis of rotation is expressed in the equation:

$$m_0 = m \frac{d}{l}.$$

- 2.4.2.2. Description of the test.
- 2.4.2.2.1. The procedure used to clamp the rear-view mirror to the support shall be that recommended by the manufacturer of the device or, where appropriate, by the vehicle manufacturer.
- 2.4.2.2.2. Positioning of the rear-view mirror for the test.
- 2.4.2.2.2.1. Rear-view mirrors shall be so positioned on the pendulum impact rig such that the axes which are horizontal and vertical when the rear-view mirror is installed on a vehicle in accordance with the demander's mounting instructions are in a similar position.
- 2.4.2.2.2.2. When a rear-view mirror is adjustable with respect to the base, the test position shall be that in which any pivoting device is least likely to operate, within the limits of adjustment provided by the demander.
- 2.4.2.2.2.3. When the rear-view mirror has a device for adjusting its distance from the base, the device must be set in the position in which the distance between the holder and the base is shortest.
- 2.4.2.2.2.4. When the reflecting surface is mobile in the holder, it shall be so adjusted that the upper corner which is furthest from the vehicle is in the position of greatest projection relative to the holder.
- 2.4.2.2.3. Except in the case of test 2 for interior rear-view mirrors (see item 2.4.2.2.6.1), when the pendulum is in a vertical position the horizontal and longitudinal vertical planes passing through the centre of the hammer shall pass through the centre of the mirror as defined in item 1.10. The longitudinal direction of oscillation of the pendulum shall be parallel to the longitudinal median plane of the vehicle.
- 2.4.2.2.4. When, under the conditions governing adjustment laid down in items 2.4.2.2.1 and 2.4.2.2.2, parts of the rear-view mirror limit the return of the hammer, the point of impact must be displaced in a direction perpendicular to the axis of rotation or pivoting in question.

This displacement must be no greater than is strictly necessary for the execution of the test; it must be limited in such a way that:

- either the sphere delimiting the hammer remains at least tangential to the cylinder as defined in paragraph 2.1.4,
- or the point of contact with the hammer is located at least 10 mm from the periphery of the reflecting surface.

- 2.4.2.2.5. The test consists in allowing the hammer to fall from a height corresponding to a pendulum angle of 60° from the vertical so that the hammer strikes the rear-view mirror at the moment when the pendulum reaches the vertical position.
- 2.4.2.2.6. The rear-view mirrors are subjected to impact under the following different conditions:
- 2.4.2.2.6.1. Interior rear-view mirrors
- Test 1 — The point of impact shall be as defined in item 2.4.2.2.3. The impact must be such that the hammer strikes the rear-view mirror on the reflecting surface side.
 - Test 2 — Point of impact on the edge of the housing, so that the impact produced makes an angle of 45° with the plane of the mirror and is situated in the horizontal plane passing through the centre of the mirror. The impact must occur on the reflecting surface side.
- 2.4.2.2.6.2. Exterior rear-view mirrors
- Test 1 — The point of impact shall be as defined in item 2.4.2.2.3 or 2.4.2.2.4. The impact must be such that the hammer strikes the rear-view mirror on the reflecting surface side.

▼M1

— Test 2 — The point of impact shall be as defined in item 2.4.2.2.3 or 2.4.2.2.4. The impact must be such that the hammer strikes the rear-view mirror on the side opposite to the reflecting surface.

2.4.3. *Bending test on the holder fixed to the stem*

2.4.3.1. Description of the test

The holder is placed horizontally in a device in such a way that the adjustment parts of the mounting can be clamped securely. In the direction of the greatest dimension of the holder, the end nearest to the point of fixing on the adjustment part is immobilized by means of a fixed stop 15 mm wide covering the entire width of the holder.

At the other end, a stop identical to the one described above is placed on the holder so that the specified test load can be applied to it (Figure 2).

The end of the holder opposite that at which the force is applied may be clamped instead of simply blocked, as shown in Figure 2.

Example of bending-test apparatus for rear-view mirror holders

Figure 2

2.4.3.2. The test load is 25 kg. It is applied for one minute.

2.5. **Results of the tests**

2.5.1. In the tests described in item 2.4.2, the pendulum must continue to swing after impact in such a way that the projection of the position assumed by the arm on the plane of release makes an angle of at least 20° with the vertical.

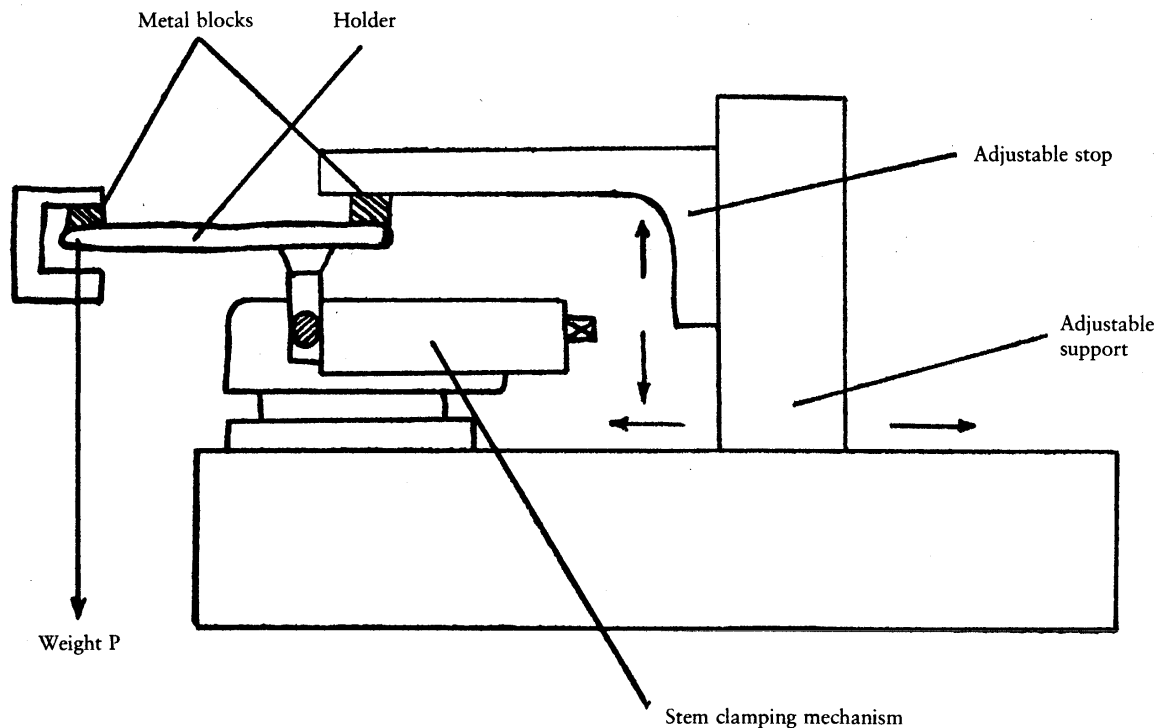
The accuracy of measurement of the angle shall be within $\pm 1^\circ$.

This requirement is not applicable to rear-view mirrors stuck to the windscreen, in respect of which the requirement stipulated in item 2.5.2 shall apply after the test.

2.5.2. Should the mounting of the rear-view mirror break during the tests described in item 2.4.2 for rear-view mirrors stuck to the windscreen, the part remaining must not project beyond the base by more than 1 cm and the configuration remaining after the test must satisfy the conditions laid down in item 2.1.3.

▼ **M1**

- 2.5.3. The mirror must not break during the tests described in items 2.4.2 and 2.4.3. However, breakage of the mirror will be allowed if one of the following conditions is fulfilled:
- 2.5.3.1. the fragments of glass still adhere to the back of the holder or to a surface firmly attached to the holder; partial separation of the glass from its backing is admissible provided this does not exceed 2.5 mm on either side of the cracks. It is permissible for small splinters to become detached from the surface of the glass at the point of impact;
- 2.5.3.2. the mirror is made of safety glass.

2.6. **EEC component type-approval conditions and marking**

- 2.6.1. *Application for EEC component type-approval*
- 2.6.1.1. Application for EEC component type-approval for a type of rear-view mirror shall be made by the holder of the trade mark or name, or by his authorized representative.
- 2.6.1.2. For each type of rear-view mirror the application shall be accompanied by:
- 2.6.1.2.1. a technical description, specifying in particular the type(s) of vehicle for which the rear-view mirror is intended;
- 2.6.1.2.2. sufficiently detailed drawings for identification of the rear-view mirror, together with instructions for mounting: the drawings must show the proposed position of the EEC component type-approval mark;
- 2.6.1.2.3. four rear-view mirrors: three for use in the tests and one to be retained by the laboratory for any further examination that might subsequently prove necessary. Additional specimens may be called for at the request of the laboratory.
- 2.6.2. *EEC component type-approval mark*
- 2.6.2.1. The EEC component type-approval mark shall consist of a rectangle surrounding the lower case letter 'e' followed by the distinguishing letter(s) or number of the Member State which has granted the component type-approval:
- 1 for Germany,
 - 2 for France,
 - 3 for Italy,
 - 4 for the Netherlands,
 - 6 for Belgium,
 - 11 for the United Kingdom,
 - 13 for Luxembourg,
 - 18 for Denmark,
 - IRL for Ireland.

It must also include in the vicinity of the rectangle the EEC component type-approval number.

This number shall consist of the component type-approval number shown on the certificate completed for the type (see Annex II), preceded by two figures indicating the sequence number of the latest amendment to Council Directive 71/127/EEC on the date EEC component type-approval was granted. The amendment sequence number and the component type-approval number shown on the certificate shall be separated by an asterisk. In this Directive the sequence number is 01.

- 2.6.2.2. The abovementioned type-approval mark (symbol and number) shall be indelibly inscribed on an essential part of the rear-view mirror in such a way as to be clearly visible even after the rear-view mirror has been mounted on a vehicle.

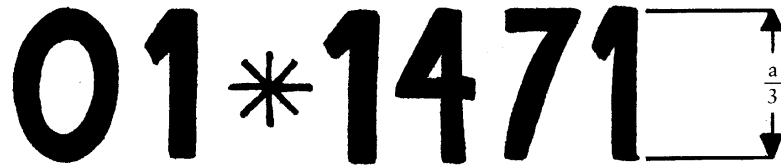
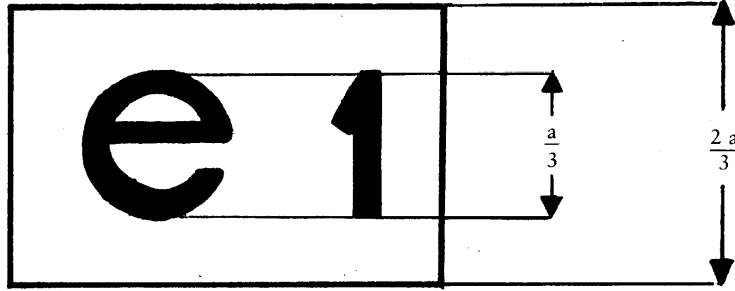
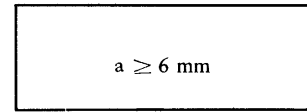
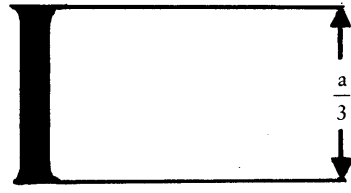
▼ M1Examples of EEC component type-approval marks⁽¹⁾

The article bearing the EEC component type-approval mark shown above is a Class I mirror (interior rear-view mirror) which has been type-approved in Germany (e 1) under number 01 * 1471.

⁽¹⁾ The numbers in the diagram are for guidance only.

▼M1

a ≥ 6 mm

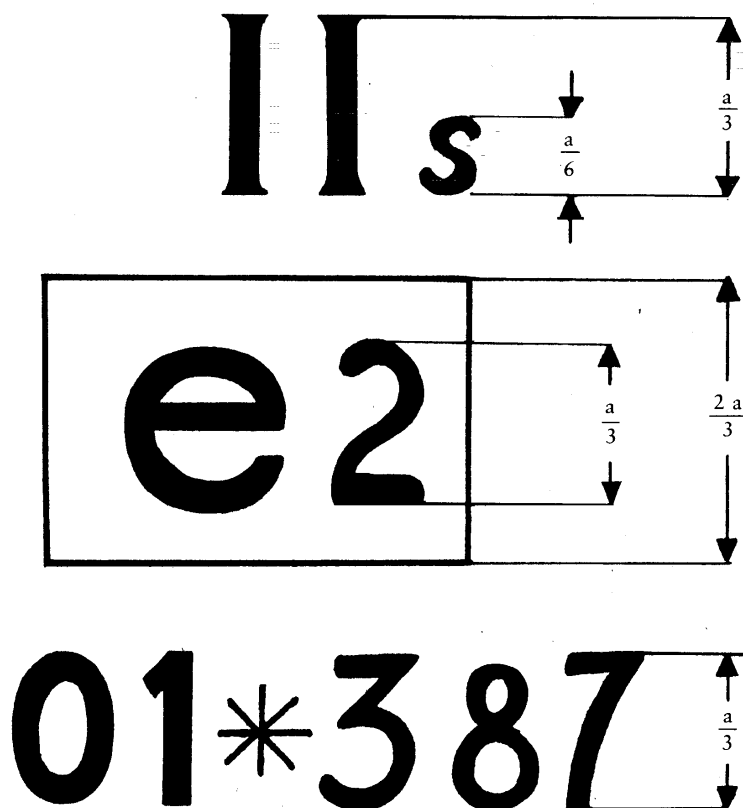

The article bearing the EEC component type-approval mark shown above is a Class II mirror (additional exterior rear-view mirror) which has been type-approved in France (e 2) under the number 01 * 387.

3. REQUIREMENTS CONCERNING FITTING TO VEHICLES

3.1. General

3.1.1. Rear-view mirrors must be fixed in such a way that the mirror does not move so as significantly to change the field of vision as measured or vibrate to an extent which would cause the driver to misinterpret the nature of the image perceived.

3.1.1.1. The conditions laid down in item 3.1.1 must be maintained when the vehicle is moving at speeds of up to 80 % of its maximum design speed, but not exceeding 150 km/h.

3.1.2. Exterior rear-view mirrors fitted on vehicles of categories M_2 , M_3 , N_2 and N_3 must be Class II mirrors and those fitted on vehicles of categories M_1 and N_1 must be Class II or Class III mirrors.

3.2. Number and position

3.2.1. Rear-view mirrors must be so placed that the driver, when sitting on the driving seat in a normal driving position, has a clear view of the road to the rear of the vehicle.

3.2.2. All vehicles of categories M_1 and N_1 must be fitted with both an interior and an exterior rear-view mirror. The latter must be fitted on the left side of the vehicle in Member States with right-hand rule of the road and on the right side of the vehicle in Member States with left-hand rule of the road.

3.2.2.1. If the interior rear-view mirror does not meet the requirements laid down in item 3.4.2, an additional exterior rear-view mirror must be fitted to the vehicle. The latter shall be fitted to the right side of the vehicle in Member States with right-hand rule of the road and to the left side of the vehicle in Member States with left-hand rule of the road.

▼ **M1**

- 3.2.2.2. If the interior rear-view mirror does not provide any rearward vision, its presence shall not be required.
- 3.2.3. All vehicles in categories M₂, M₃, N₂ and N₃ must be fitted with two exterior rear-view mirrors, one on each side of the vehicle.
- 3.2.4. Exterior rear-view mirrors shall be visible through the side windows or through the portion of the windscreen that is swept by the windscreen wiper. This provision shall not apply to exterior rear-view mirrors fitted on the right side of vehicles of categories M₂ and M₃ in Member States with right-hand rule of the road and on the left side of vehicles of the same categories in Member States with left-hand rule of the road.
- 3.2.5. In the case of any vehicle which is in chassis/cab form when the field of vision is measured, the minimum and maximum body widths shall be stated by the manufacturer and, if necessary, simulated by dummy head boards. All vehicle and mirror configurations taken into consideration during the tests shall be shown on the type-approval certificate.
- 3.2.6. A two-plane or 'double' mirror is not permitted if both planes are necessary to meet the field-of-vision requirements. However, if the main glass meets all the requirements for a Class II or III mirror, it is acceptable. The auxiliary glass will be taken into account in the determination of the height from the ground and of the projection in accordance with item 3.2.10. The enclosure of the auxiliary glass must also comply with the conditions specified in item 2.1.2.
- 3.2.7. The prescribed exterior rear-view mirror on the driver's side of the vehicle must be so located that an angle of not more than 55° is formed between the vertical longitudinal median plane of the vehicle and the vertical plane passing through the centre of the rear-view mirror and through the centre of the straight line 65 mm long which joins the driver's two ocular points.
- 3.2.8. Rear-view mirrors must not project beyond the external bodywork of the vehicle substantially more than is necessary to comply with the requirements concerning fields of vision laid down in item 3.4.
- 3.2.9. Where the lower edge of an exterior rear-view mirror is less than 2 m above the ground when the vehicle is laden, this rear-view mirror must not project more than 0.20 m beyond the overall width of the vehicle measured without rear-view mirrors.
- 3.2.10. Subject to the requirements of items 3.2.8 and 3.2.9, rear-view mirrors may project beyond the permissible maximum widths of vehicles.
- 3.3. **Adjustment**
- 3.3.1. The interior rear-view mirror must be capable of being adjustable by the driver from his driving position.
- 3.3.2. The exterior rear-view mirror situated on the driver's side must be capable of being adjusted from inside the vehicle while the door is closed, although the window may be open. The mirror may, however, be locked in position from the outside.
- 3.3.3. The requirements of item 3.3.2 do not apply to exterior rear-view mirrors which, after having been knocked out of alignment, can be returned to their former position without the need for adjustment.
- 3.4. **Fields of vision**
- 3.4.1. *General*
- The fields of vision defined below must apply in respect of ambino-cular vision, the eyes being at the 'driver's ocular points' as defined in item 1.12 above. The fields of vision shall be determined when the vehicle is in running order as defined in item 2.6 of Annex I to Directive 70/156/EEC and is carrying in addition one front-seat passenger, the mass of the passenger being 75 kg ± 1 %. They must be established through windows which have a total light transmission factor of at least 70% measured perpendicularly to the surface.
- 3.4.2. *Interior rear-view mirror*
- The field of vision must be such that the driver can see at least a 20 m-wide, flat, horizontal portion of the road centred on the vertical longitudinal median plane of the vehicle and extending

▼M1

from 60 m behind the driver's ocular points (Figure 3) to the horizon.

- 3.4.2.1. It is permissible for the field of vision to be reduced by the presence of head restraints and such devices as sun visors, rear windscreen wipers and heating elements, provided that they do not obscure more than 15% of the prescribed field of vision when projected onto a vertical plane perpendicular to the longitudinal median plane of the vehicle.
- 3.4.3. *Left-hand exterior rear-view mirror for vehicles driven on the right of the road and right-hand exterior rear-view mirror for vehicles driven on the left of the road.*
- 3.4.3.1. The field of vision must be such that the driver can see at least a 2·50 m-wide, flat, horizontal portion of the road, which is bounded on the right (in the case of vehicles driven on the right), or on the left (in the case of vehicles driven on the left) by the plane which is parallel to the median longitudinal vertical plane passing through the outermost point of the vehicle on the left (in the case of vehicles driven on the right), or on the right (in the case of vehicles driven on the left) and extends from 10 m behind the driver's ocular points to the horizon (Figure 4).
- 3.4.4. *Right-hand exterior rear-view mirror for vehicles driven on the right and left-hand exterior rear-view mirror for vehicles driven on the left.*
- 3.4.4.1. The field of vision must be such that the driver can see at least a 3·50 m-wide, flat, horizontal portion of the road, which is bounded on the left (in the case of vehicles driven on the right), or on the right (in the case of vehicles driven on the left) by a plane parallel to the median longitudinal vertical plane of the vehicle and passing through the outermost point of the vehicle on the right (in the case of vehicles driven on the right) or on the left (in the case of vehicles driven on the left) and which extends from 30 m behind the driver's ocular points to the horizon.
- 3.4.4.2. In addition, the road must be visible to the driver over a width of 0·75 m, from a point 4 m behind the vertical plane passing through the driver's ocular points (Figure 4).
- 3.4.5. *Obstructions*
- In the determination of the fields of vision specified above, no account is taken of obstructions caused by door handles, outline marker lights, direction indicators, the extremities of rear bumpers and obstructions due to the bodywork similar to those caused by the abovementioned elements.
- 3.4.6. *Test procedure*
- The field of vision shall be determined by placing powerful light sources at the ocular points and examining the light reflected on a vertical monitoring screen. Other, equivalent methods may be used.

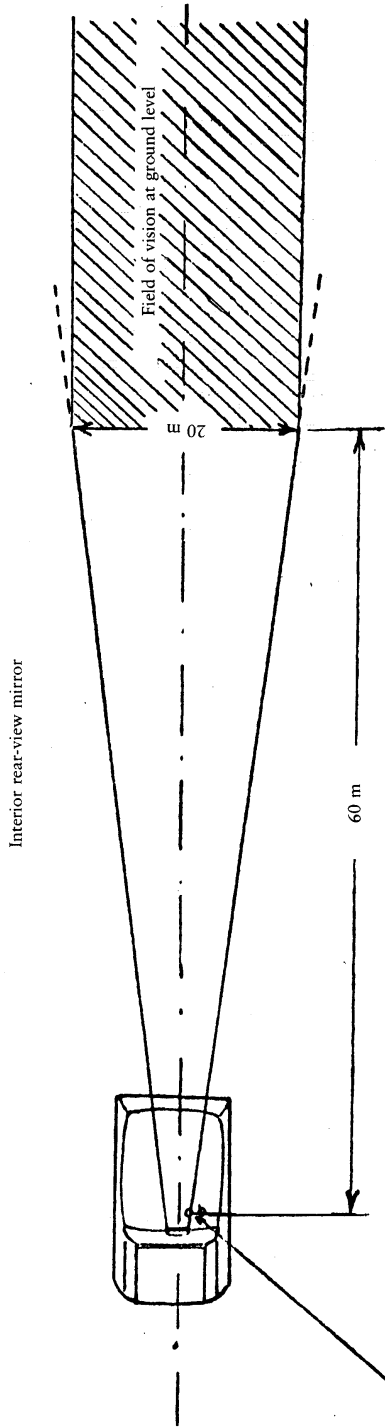

Figure 3

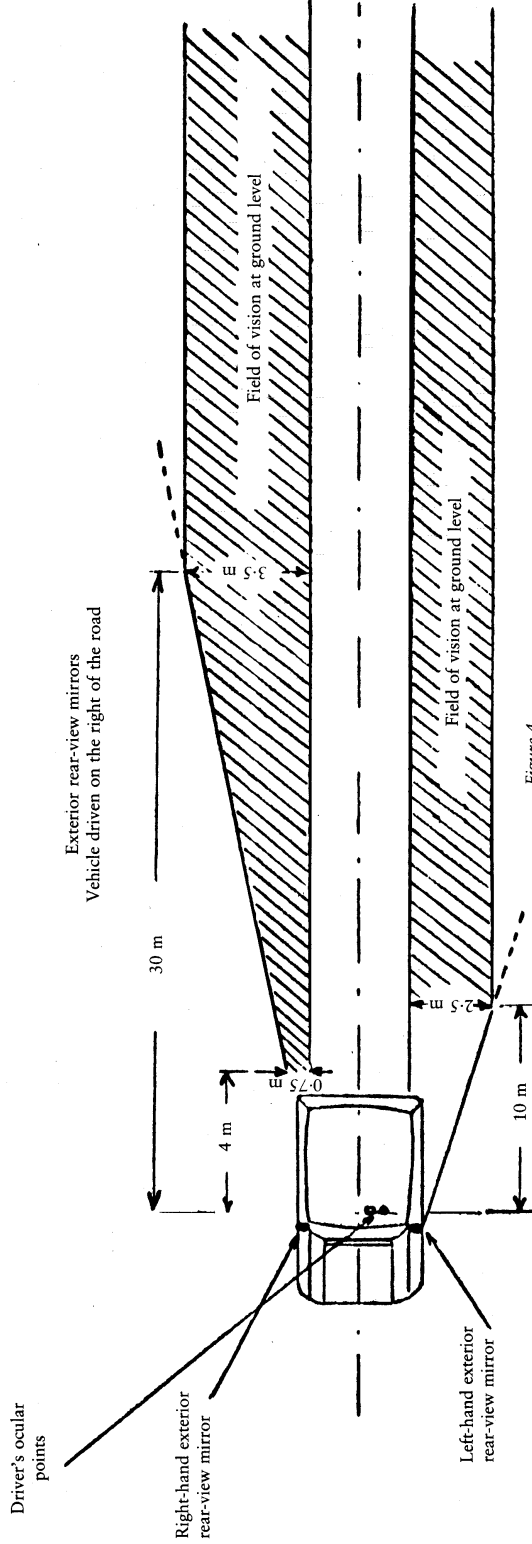

Figure 4

▼M1*Appendix 1***PROCEDURE FOR DETERMINING THE RADIUS OF CURVATURE 'r'
OF A MIRROR'S REFLECTION SURFACE**

1. MEASUREMENTS

1.1. **Equipment**

The 'spherometer' described in Figure 1 is used.

1.2. **Measuring points**

1.2.1. The principal radii of curvature shall be measured at three points situated as close as possible to positions at one third, half and two thirds of the distance along the arc of the reflecting surface passing through the centre of the mirror and parallel to segment b, or of the arc passing through the centre of the mirror which is perpendicular to it if this arc is the longer.

1.2.2. Where, owing to the size of the mirror, it is impossible to obtain measurements in the directions defined in item 1.8 of Annex I, the technical services responsible for the tests may take measurements at the said point in two perpendicular directions as close as possible to those prescribed above.

2. CALCULATION OF THE RADIUS OF CURVATURE (r)

'r' expressed in mm is calculated from the formula:

$$r = \frac{r_{p1} + r_{p2} + r_{p3}}{3}$$

where:

r_{p1} = the radius of curvature at the first measuring point,

r_{p2} = the radius of curvature at the second measuring point,

r_{p3} = the radius of curvature at the third measuring point.

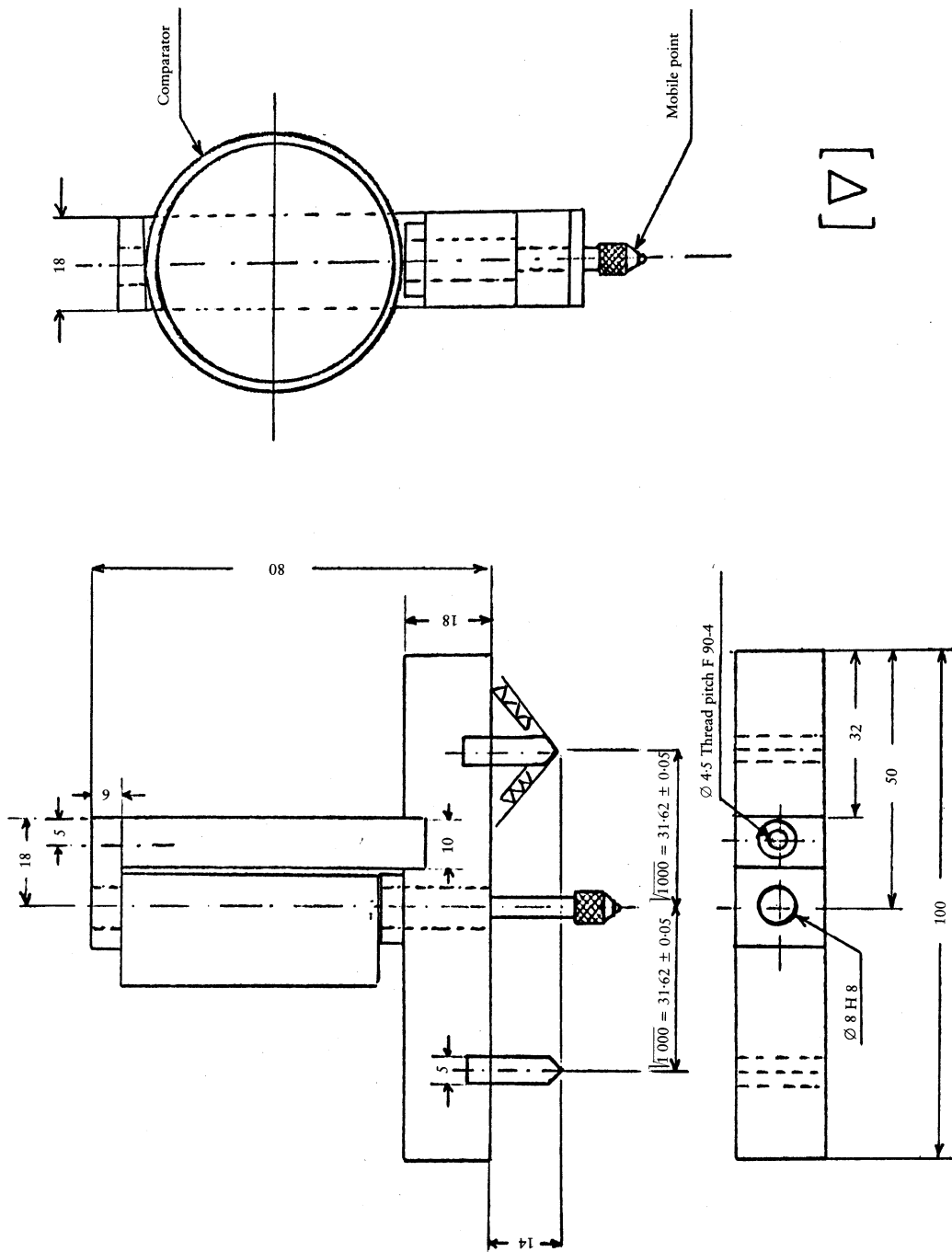

Figure 1

TEST METHOD FOR DETERMINING REFLECTIVITY

1. DEFINITIONS

- 1.1. 'CIE standard illuminant A¹⁾': Colorimetric illuminant, respecting the full radiator at $T_{68} = 2\,855.6$ K.
- 1.2. 'CIE standard source A¹⁾': Gas-filled tungsten filament lamp operating at a correlated colour temperature of $T_{68} = 2\,855.6$ K.
- 1.3. 'CIE 1931 standard colorimetric observer' (¹⁾): Receptor of radiation whose colorimetric characteristics correspond to the spectral tristimulus values $\bar{x}(\lambda)$, $\bar{y}(\lambda)$, $\bar{z}(\lambda)$ (see table).
- 1.4. 'CIE spectral tristimulus values' (¹⁾): Tristimulus values of the spectral components of an equi-energy spectrum in the CIE (XYZ) system.
- 1.5. 'Photopic vision' (¹⁾): Vision by the normal eye when it is adapted to levels of luminance of at least several candelas per square metre.

2. APPARATUS

2.1. General

The apparatus shall consist of a light source, a holder for the test sample, a receiver unit with a photodetector and an indicating meter (see figure 1), and means of eliminating the effects of extraneous light.

The receiver may incorporate a light-integrating sphere to facilitate measuring the reflectance of non-flat (convex) mirrors (see figure 2).

2.2. Spectral characteristics of light source and receiver

The light source shall consist of a CIE standard source A and associated optics to provide a near-collimated light beam. A voltage stabilizer is recommended in order to maintain a fixed lamp voltage during instrument operation.

The receiver shall have a photodetector with a spectral response proportional to the photopic luminosity function of the CIE (1931) standard colorimetric observer (see table). Any other combination of illuminant-filter-receptor giving the overall equivalent of CIE standard illuminant A and photopic vision may be used. When an integrating sphere is used in the receiver, the interior surface of the sphere shall be coated with a matt (diffusive) spectrally non-selective white coating.

2.3. Geometrical conditions

The angle of the incident beam (θ) should preferably be 0.44 ± 0.09 rad ($25 \pm 5^\circ$) from the perpendicular to the test surface and shall not exceed the upper limit of the tolerance (i.e. 0.53 rad or 30°). The axis of the receptor shall make an angle (θ) with this perpendicular equal to that of the incident beam (see figure 1). The incident beam upon arrival at the test surface shall have a diameter of not less than 19 mm (0.75 in). The reflected beam shall not be wider than the sensitive area of the photodetector, shall not cover less than 50% of such area, and as nearly as possible shall cover the same area segment as used during instrument calibration.

When an integrating sphere is used in the receiver section, the sphere shall have a minimum diameter of 127 mm (5 in). The sample and incident beam apertures in the sphere wall shall be of such a size as to admit the entire incident and reflected light beams. The photodetector shall be so located as not to receive direct light from either the incident or the reflected beam.

2.4. Electrical characteristics of the photodetector-indicator unit

The photodetector output as read on the indicating meter shall be a linear function of the light intensity on the photosensitive area. Means (electrical and/or optical) shall be provided to facilitate zeroing and calibration adjust-

(¹⁾ Definitions taken from CIE publication 50 (45), International Electrotechnical Vocabulary, Group 45: Lighting.

▼ **M1**

ments. Such means shall not affect the linearity or the spectral characteristics of the instrument. The accuracy of the receptor-indicator unit shall be within $\pm 2\%$ of full scale, or $\pm 10\%$ of the magnitude of the reading, whichever is the smaller.

2.5. Sample holder

The mechanism shall be capable of locating the test sample so that the axes of the source arm and receptor intersect at the reflecting surface. The reflecting surface may lie within or at either face of the mirror sample, depending on whether it is a first-surface, second-surface or prismatic 'flip'-type mirror.

3. PROCEDURE**3.1. Direct calibration method**

In the direct calibration method, air is used as the reference standard. This method is applicable for those instruments which are so constructed as to permit calibration at the 100% point by swinging the receiver to a position directly on the axis of the light source (see figure 1).

It may be desired in some cases (such as when measuring low-reflectivity surfaces) to use an intermediate calibration point (between 0 and 100% on the scale) with this method. In these cases, a neutral density filter of known transmittance shall be inserted in the optical path, and the calibration control shall then be adjusted until the meter reads the percentage transmission of the neutral density filter. This filter shall be removed before reflectivity measurements are performed.

3.2. Indirect calibration method

The indirect calibration method is applicable in the case of instruments with fixed source and receiver geometry. A properly calibrated and maintained reflectance standard is required. This reference standard should preferably be a flat mirror with a reflectance value as near as possible to that of the test samples.

3.3. Flat mirror measurement

The reflectance of flat mirror samples can be measured on instruments employing either the direct or the indirect calibration method. The reflectance value is read directly from the indicating meter.

3.4. Non-flat (convex) mirror measurement

Measurement of the reflectance of non-flat (convex) mirrors requires the use of instruments which incorporate an integrating sphere in the receiver unit (see figure 2). If the instrument indicating meter indicates n_x divisions with a standard mirror of $E\%$ reflectance, then, with a mirror of unknown reflectance, n_x divisions will correspond to a reflectance of $X\%$, in accordance with the formula

$$X = E \frac{n_x}{n_e}$$

▼M1

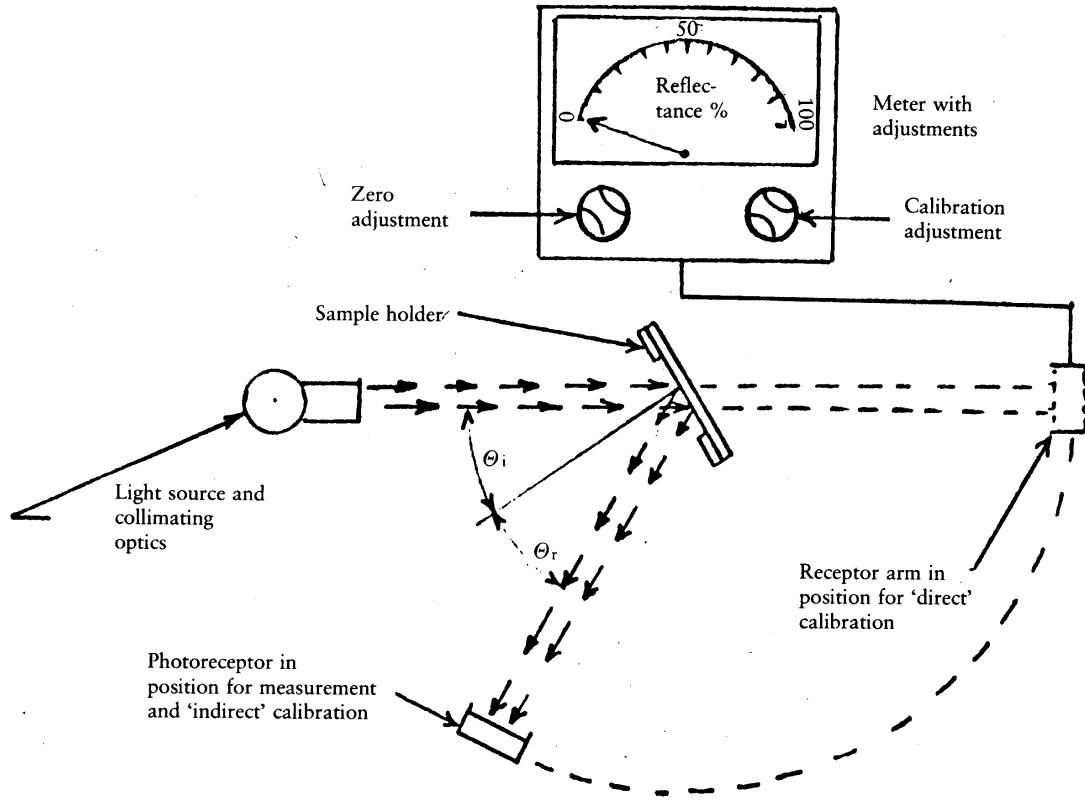

Figure 1. Generalized reflectometer showing geometries for the two calibration methods

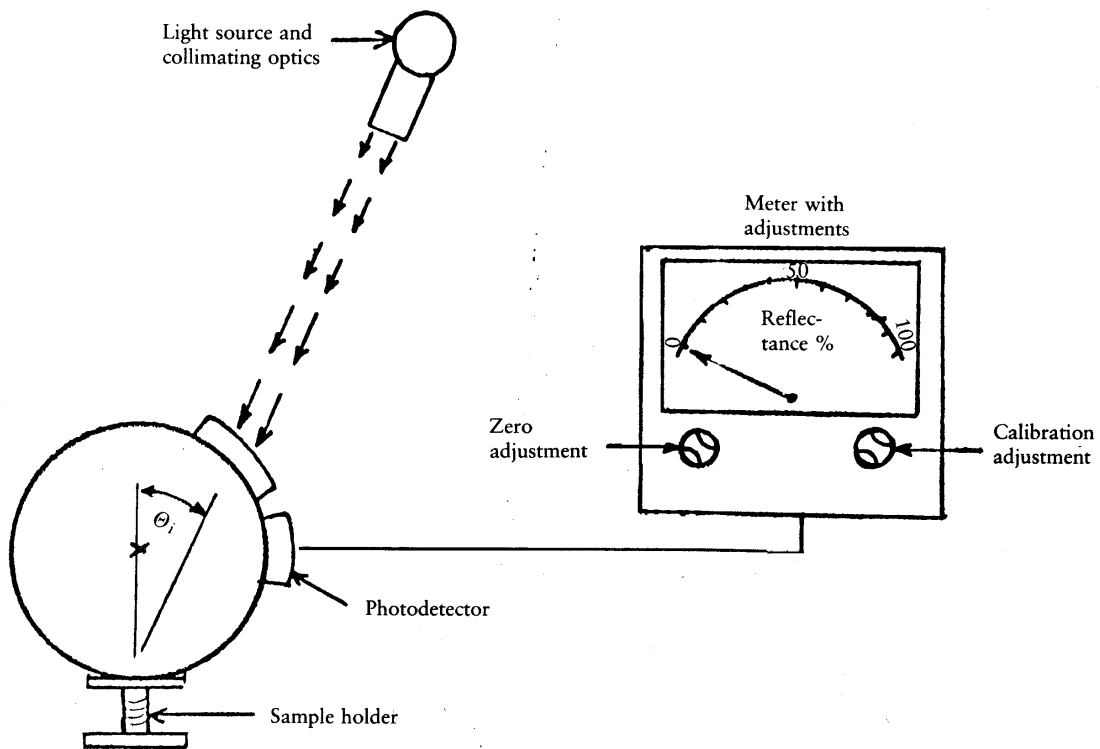

Figure 2. Generalized reflectometer incorporating an integrating sphere in the receiver

▼ **M1****Spectral tristimulus values for the CIE 1931 standard colorimetric observer⁽¹⁾**

(This table is taken from IEC publication 50 (45) (1970))

λ nm	$\bar{x}(\lambda)$	$\bar{y}(\lambda)$	$\bar{z}(\lambda)$
380	0-001 4	0-000 0	0-006 5
390	0-004 2	0-000 1	0-020 1
400	0-014 3	0-000 4	0-067 9
410	0-043 5	0-001 2	0-207 4
420	0-134 4	0-004 0	0-645 6
430	0-283 9	0-011 6	1-385 6
440	0-348 3	0-023 0	1-747 1
450	0-336 2	0-038 0	1-772 1
460	0-290 8	0-060 0	1-669 2
470	0-195 4	0-091 0	1-287 6
480	0-095 6	0-139 0	0-813 0
490	0-032 0	0-208 0	0-465 2
500	0-004 9	0-323 0	0-272 0
510	0-009 3	0-503 0	0-158 2
520	0-063 3	0-710 0	0-078 2
530	0-165 5	0-862 0	0-042 2
540	0-290 4	0-954 0	0-020 3
550	0-433 4	0-995 0	0-008 7
560	0-594 5	0-995 0	0-003 9
570	0-762 1	0-952 0	0-002 1
580	0-916 3	0-870 0	0-001 7
590	1-026 3	0-757 0	0-001 1
600	1-062 2	0-631 0	0-000 8
610	1-002 6	0-503 0	0-000 3
620	0-354 4	0-381 0	0-000 2
630	0-642 4	0-265 0	0-000 0
640	0-447 9	0-175 0	0-000 0
650	0-283 5	0-107 0	0-000 0
660	0-164 9	0-061 0	0-000 0
670	0-087 4	0-032 0	0-000 0
680	0-046 8	0-017 0	0-000 0
690	0-022 7	0-008 2	0-000 0
700	0-011 4	0-004 1	0-000 0
710	0-005 8	0-002 1	0-000 0
720	0-002 9	0-001 0	0-000 0
730	0-001 4	0-000 5	0-000 0
740	0-000 7	0-000 2 ⁽¹⁾	0-000 0
750	0-000 3	0-000 1	0-000 0
760	0-000 2	0-000 1	0-000 0
770	0-000 1	0-000 0	0-000 0
780	0-000 0	0-000 0	0-000 0

⁽¹⁾ Changed in 1966 (from 3 to 2).⁽¹⁾ Abridged table. The values of $\bar{y}(\lambda) = V(\lambda)$ are rounded off to four decimal places.

▼ M1

ANNEX II

MODEL EEC COMPONENT TYPE-APPROVAL CERTIFICATE

Name of administration

Notification concerning the grant, refusal or withdrawal of EEC component type-approval for a type or rear-view mirror

- EEC component type-approval No
1. Trade name or mark
 2. Class (I, II, III, Is, IIs, IIIs) ⁽¹⁾
 3. Name and address of manufacturer
 4. If applicable, name and address of manufacturer's authorized representative
 5. Symbol $\frac{\wedge}{2 \text{ m}}$ defined in item 2.4.1.1 of Annex I: yes/no ⁽¹⁾
 6. Submitted for type-approval on
 7. Test laboratory
 8. Date and number of laboratory report
 9. Date of grant/refusal/withdrawal of EEC component type-approval ⁽¹⁾
 10. Place
 11. Date
 12. The following documents, bearing the type-approval number shown above, are annexed to this type-approval certificate
- (descriptive notes, drawings, diagrams and plans of the rear-view mirror)
These documents must be supplied to the competent authorities of the other Member States at their express request.
13. Remarks, if any, particularly as regards restrictions on use and/or conditions for fitting

.....
(Signature)

⁽¹⁾ Delete where inapplicable.

▼ M1

ANNEX III

ANNEX TO THE EEC TYPE-APPROVAL CERTIFICATE FOR A VEHICLE WITH REGARD TO THE INSTALLATION OF REAR-VIEW MIRRORS

(Articles 4 (2) and 10 of Council Directive 70/156/EEC of 6 February 1970 on the approximation of the laws of the Member States relating to the type-approval of motor vehicles and their trailers)

Name of administration

- EEC type-approval No extension ⁽¹⁾
1. Trade name or mark of vehicle
 2. Type of vehicle
 3. Name and address of vehicle manufacturer
 4. If applicable, name and address of authorized representative
 5. Trade name or mark of rear-view mirrors and component type-approval number
 6. Extension of EEC type-approval of the vehicle to cover the following rear-view mirror type
 7. Data for identification of the R point of the driver's seating position
 8. Maximum and minimum bodywork widths in respect of which the rear-view mirror has been granted type-approval (in the case of chassis/cabs referred to in item 3.2.5 of Annex I)
 9. Vehicle submitted for EEC type-approval on
 10. Technical department responsible for checking conformity for the purpose of EEC type-approval
 11. Date of report issued by that department
 12. Number of report issued by that department
 13. EEC type-approval in respect of the installation of rear-view mirrors has been granted/refused ⁽¹⁾
 14. An extension of EEC type-approval in respect of the installation of rear-view mirrors has been granted/refused ⁽²⁾
 15. Place
 16. Date
 17. Signature

⁽¹⁾ Where appropriate, state whether the extension of the initial EEC type-approval is the first, second, etc.

⁽²⁾ Delete where inapplicable.

▼ M1

18. The following documents, bearing the type-approval number shown above, are annexed to this certificate:
- drawings showing the mountings of the rear-view mirrors,
 - drawings and plans showing the mounting positions and the characteristics of the part of the structure where the rear-view mirrors are mounted,
 - general view from the front, the rear and the passenger compartment showing where the rear-view mirrors are fitted.

These documents must be supplied to the competent authorities of the other Member States at their express request.

▼ M1

ANNEX IV

**PROCEDURE FOR DETERMINING THE H POINT AND VERIFYING
THE RELATIVE POSITIONS OF THE R AND H POINTS**

The relevant parts of Annex III to Directive 77/649/EEC are applicable.