

This document is meant purely as a documentation tool and the institutions do not assume any liability for its contents

► **B**

COUNCIL DIRECTIVE

of 20 March 1970

► **M4** on the approximation of the laws of the Member States relating to measures to be taken against air pollution by gases from engines of motor vehicles ◀

(70/220/EEC)

(OJ L 76, 6.4.1970, p. 1)

Amended by:

	Official Journal		
	No	page	date
► <u>M1</u> Council Directive 74/290/EEC of 28 May 1974	L 159	61	15.6.1974
► <u>M2</u> Commission Directive 77/102/EEC of 30 November 1976	L 32	32	3.2.1977
► <u>M3</u> Commission Directive 78/665/EEC of 14 July 1978	L 223	48	14.8.1978
► <u>M4</u> Council Directive 83/351/EEC of 16 June 1983	L 197	1	20.7.1983
► <u>M5</u> Council Directive 88/76/EEC of 3 December 1987	L 36	1	9.2.1988

Amended by:

► <u>A1</u> Act of Accession of Denmark, Ireland and the United Kingdom of Great Britain and Northern Ireland	L 73	14	27.3.1972
--	------	----	-----------

▼B

COUNCIL DIRECTIVE
of 20 March 1970

►M4 on the approximation of the laws of the Member States relating to measures to be taken against air pollution by gases from engines of motor vehicles ◄

(70/220/EEC)

THE COUNCIL OF THE EUROPEAN COMMUNITIES,

Having regard to the Treaty establishing the European Economic Community, and in particular Article 100 thereof;

Having regard to the proposal from the Commission;

Having regard to the Opinion of the European Parliament⁽¹⁾;

Having regard to the Opinion of the Economic and Social Committee⁽²⁾;

Whereas a regulation of 14 October 1968 amending the *Straßenverkehrs-Zulassungs-Ordnung* was published in Germany in the *Bundesgesetzblatt* Part I of 18 October 1968; whereas that regulation contains provisions on measures to be taken against air pollution by positive-ignition engines of motor vehicles; whereas those provisions will enter into force on 1 October 1970;

Whereas a regulation of 31 March 1969 on the 'Composition of exhaust gases emitted from petrol engines of motor vehicles' was published in France in the *Journal officiel* of 17 May 1969; whereas that regulation is applicable:

- from 1 September 1971, to type-approved vehicles with a new type of engine, that is to say, a type of engine which has never before been installed in a type-approved vehicle;
- from 1 September 1972, to vehicles put into service for the first time;

Whereas those provisions are liable to hinder the establishment and proper functioning of the common market; whereas it is therefore necessary that all Member States adopt the same requirements, either in addition to or in place of their existing rules, in order, in particular, to allow the EEC type — approval procedure which was the subject of the Council Directive⁽³⁾ of 6 February 1970 on the approximation of the laws of the Member States relating to the type approval of motor vehicles and their trailers to be applied in respect of each type of vehicle;

Whereas, however, the present Directive will be applied before the date laid down for the application of the Directive of 6 February 1970; whereas at that time therefore the procedures of this last Directive will not yet be applicable; whereas therefore an *ad hoc* procedure must be laid down in the form of a communication certifying that a vehicle type has been tested and that it satisfies the requirements of this Directive;

Whereas, on the basis of that communication, each Member State requested to grant national type approval of a type of vehicle must be able to ascertain whether that type has been submitted to the tests laid down in this Directive; whereas, to this end, each Member State should inform the other Member States of its findings by sending them a copy of the communication completed for each type of motor vehicle which has been tested;

Whereas a longer period of adaptation should be laid down for industry in respect of the requirements relating to the testing of the average emission of gaseous pollutants in a congested urban area after a cold

⁽¹⁾ OJ No C 160, 18.12.1969, p. 7.

⁽²⁾ OJ No C 48, 16.4.1969, p. 16.

⁽³⁾ OJ No L 42, 23.2.1970, p. 1.

▼B

start than in respect of the other technical requirements of this Directive;

Whereas it is desirable to use the technical requirements adopted by the UN Economic Commission for Europe in its Regulation No 15⁽¹⁾ (Uniform provisions concerning the approval of vehicles equipped with a positive-ignition engine with regard to the emission of gaseous pollutants by the engine), annexed to the Agreement of 20 March 1958 concerning the adoption of uniform conditions of approval and reciprocal recognition of approval for motor vehicle equipment and parts;

Whereas, furthermore, the technical requirements must be rapidly adapted to take account of technical progress; whereas, to this end, provision should be made for application of the procedure laid down in Article 13 of the Council Directive of 6 February 1970 on the type approval of motor vehicles and their trailers;

HAS ADOPTED THIS DIRECTIVE:

▼M4*Article 1*

For the purposes of this Directive, 'vehicle' means any vehicle with a positive-ignition engine or with a compression-ignition engine, intended for use on the road, with or without bodywork, having at least four wheels, a permissible maximum mass of at least 400 kg and a maximum design speed equal to or exceeding 50 km/h, with the exception of agricultural tractors and machinery and public works vehicles.

▼B*Article 2*

No Member State may refuse to grant EEC type approval or national type approval of a vehicle on grounds relating to air pollution by gases from positive-ignition engines of motor vehicles:

- from 1 October 1970, where that vehicle satisfies both the requirements contained in Annex I, with the exception of those in items 3.2.1.1 and 3.2.2.1, and the requirements contained in Annexes II, IV, V and VI;
- from 1 October 1971, where that vehicle satisfies, in addition, the requirements contained in items 3.2.1.1 and 3.2.2.1 of Annex I and in Annex III.

▼A1*Article 2a*

No Member State may refuse or prohibit the sale or registration, entry into service or use of a vehicle on grounds relating to air pollution by gases from positive-ignition engines of motor vehicles if that vehicle satisfies the requirements set out in Annexes I, II, III, IV, V and VI.

▼B*Article 3*

1. On application being made by a manufacturer or his authorised representative, the competent authorities of the Member State concerned shall complete the sections of the communication provided for in Annex VII. A copy of that communication shall be sent to the other Member States and to the applicant. Other Member States which are requested to grant national type approval for the same type of vehicle shall accept that document as proof that the tests provided for have been carried out.

2. The provisions of paragraph 1 shall be revoked as soon as the Council Directive of 6 February 1970 on the type approval of motor vehicles and their trailers enters into force.

⁽¹⁾ ECE (Geneva) Document W/TRANS/WP 29/293/Rev. 1, 11.4.1969.

▼B*Article 4*

The Member State which has granted type approval shall take the necessary measures to ensure that it is informed of any modification of a part or characteristic referred to in item 1.1 of Annex I. The competent authorities of that Member State shall determine whether fresh tests should be carried out on the modified prototype and whether a fresh report should be drawn up. Where such tests reveal failure to comply with the requirements of this Directive, the modification shall not be approved.

Article 5

The amendments necessary for adjusting the requirements of Annexes I to VII so as to take account of technical progress shall be adopted in accordance with the procedure laid down in Article 13 of the Council Directive of 6 February 1970 on the type approval of motor vehicles and their trailers.

Article 6

1. Member States shall adopt provisions containing the requirements needed in order to comply with this Directive before 30 June 1970 and shall forthwith inform the Commission thereof.
2. Member States shall ensure that they communicate to the Commission the text of the main provisions of national law which they adopt in the field covered by this Directive.

Article 7

This Directive is addressed to the Member States.

▼ **M4**

ANNEX I

SCOPE, DEFINITIONS, APPLICATION FOR EEC TYPE-APPROVAL, EEC TYPE-APPROVAL, SPECIFICATIONS AND TESTS, EXTENSION OF EEC TYPE-APPROVAL, CONFORMITY OF PRODUCTION, TRANSITIONAL PROVISIONS

1. SCOPE

This Directive applies to the emission of gaseous pollutants from all motor vehicles equipped with positive-ignition engines and from vehicles of categories M₁ and N₁⁽¹⁾ equipped with compression-ignition engines, covered by Article 1 ► **M5**, with the exception of those vehicles of category N₁, for which type +approval has been granted under Directive 88/76/EEC⁽²⁾.

At the request of the manufacturers, type +approval to this Directive may be extended from M₁ or N₁ vehicles equipped with compression +ignition engines which have already been type +approved to M₂ and N₂ vehicles having a reference mass not exceeding 2 840 kg and meeting the conditions of section 6 of this Annex (extension of EEC type +approval). ◀

2. DEFINITIONS

For the purposes of this Directive:

- 2.1. 'Vehicle type', with regard to the emission of gaseous pollutants from the engine, means a category of power-driven vehicles which do not differ in such essential respects as:
 - 2.1.1. the equivalent inertia determined in relation to the reference mass as prescribed in 5.1 of Annex III; and
 - 2.1.2. the engine and vehicle characteristics as defined in 1 to 6 and 8 of Annex II and Annex VII.
- 2.2. ► **M5** For the purposes of Annex IIIA 'reference mass' means the mass of the vehicle in running order less the uniform mass of the driver of 75 kg and increased by a uniform mass of 136 kg. ◀
 - 2.2.1. 'Mass of the vehicle in running order' means the mass defined under 2.6 of Annex I to Directive 70/156/EEC.
- 2.3. 'Maximum mass' means the mass defined under 2.7 of Annex I to Directive 70/156/EEC.
- 2.4. 'Gaseous pollutants' means carbon monoxide, hydrocarbons (assuming a ratio of CH_{1,85}), and oxides of nitrogen, the latter being expressed in nitrogen dioxide (NO₂) equivalent.
- 2.5. 'Engine crankcase' means the spaces in or external to an engine which are connected to the oil sump by internal or external ducts through which gases and vapours can escape.
- 2.6. 'Cold start device' means a device which enriches the air/fuel mixture of the engines temporarily, thus assisting the engine to start.
- 2.7. 'Starting aid' means a device which assists the engine to start without enrichment of the air/fuel mixture of the engine, e.g. glow plugs, modifications to the injection timing.

▼ **M5**

- 2.8. 'Engine capacity' means:
 - 2.8.1. for reciprocating piston positive +ignition engines, the nominal engine swept volume,
 - 2.8.1.1. for rotary piston (Wankel) positive +ignition engines, double the nominal engine swept volume.

⁽¹⁾ As defined in 0.4 of Annex I to Directive 70/156/EEC (OJ No L 42, 23. 2. 1970, p. 1).

⁽²⁾ OJ No L 36, 9. 2. 1988, p. 1.

▼ M4

3. APPLICATION FOR EEC TYPE-APPROVAL

- 3.1. The application for approval of a vehicle type with regard to the emission of gaseous pollutants from its engine is submitted by the vehicle manufacturer or by his authorized representative.
- 3.2. It is accompanied by the following documents in triplicate and by the following particulars:
- 3.2.1. a description of the engine type comprising all the particulars referred to in Annex II;
- 3.2.2. drawings of the combustion chamber and of the piston, including the piston rings;
- 3.2.3. maximum lift of valves and angles of opening and closing in relation to dead centres;

▼ M5

- 3.2.4. a description of the measures taken to ensure that a vehicle equipped with a positive +ignition engine is so constructed that it can only be supplied with unleaded petrol in accordance with Directive 85/210/EEC.

This condition is deemed to be met if it can be demonstrated that the inlet orifice of the fuel tank is so designed that it prevents the tank from being filled from a petrol pump delivery nozzle which has an external diameter of 23,6 mm or greater.

▼ M4

- 3.3. A vehicle representative of the vehicle type to be approved is submitted for the tests described in 5 of this Annex to the technical service responsible for the type-approval tests.

4. EEC TYPE-APPROVAL

- 4.1. A form conforming to the model set out in Annex VII must be attached to the EEC type-approval certificate.

5. REQUIREMENTS AND TESTS

5.1. **General**

- **M5** 5.1.1. ◀ The components liable to affect the emission of gaseous pollutants must be so designed, constructed and assembled as to enable the vehicle, in normal use, to comply with the requirements of this Directive, despite the vibration to which they may be subjected.

▼ M5

The technical measures taken by the manufacturer must be such as to ensure that the emission of air +polluting gases is effectively limited throughout the normal life of the vehicle and under normal conditions of use.

- 5.1.2. A vehicle equipped with a positive +ignition engine must be designed to be capable of running on unleaded petrol as specified by Directive 85/210/EEC.

▼ M45.2. **Description of tests**

- 5.2.1. The vehicle must, according to its category, be subjected to tests of different types, as specified below. The tests are:
- type I, II and III if powered by a positive-ignition engine, and
 - type I if powered by a compression-ignition engine.
- 5.2.1.1. *Type I test* (verifying the average emission of gaseous pollutants after a cold start)
- 5.2.1.1.1. This test must be carried out on all vehicles referred to in 1, of a maximum mass not exceeding 3,5 tonnes.
- 5.2.1.1.2. The vehicle is placed on a dynamometer bench equipped with a means of load and inertia simulation. A test lasting a total of 13 minutes and comprising four cycles is performed without interruption. Each cycle comprises 15 phases (idling, acceleration, steady speed, deceleration, etc.). During the test the exhaust gases are diluted and a proportional sample collected in one or more bags. The exhaust gases of the vehicle tested are diluted, sampled and analyzed following the procedure described below; the total volume of the diluted exhaust is measured.

▼ **M4**

- 5.2.1.1.3. The test is carried out by the procedure described in Annex III. The methods used to collect and analyze the gases must be those prescribed. Other analysis methods may be approved if it is found that they yield equivalent results.

▼ **M5**

- 5.2.1.1.4. Subject to 5.2.1.1.4.2 and 5.2.1.1.5, the test is repeated three times. The mass of the carbon monoxide, the combined mass of the hydrocarbons and the nitrogen oxides and the mass of the nitrogen oxides obtained must be less than the amounts given below for the corresponding vehicle categories:

Engine capacity C (cm ³)	Mass of carbon monoxide L1 (g/test)	Combined mass of hydrocarbons and nitrogen oxides L2 (g/test)	Mass of nitrogen oxides L3 (g/test)
C > 2 000	25	6,5	3,5
1 400 ≤ C ≤ 2 000	30	8	
C < 1 400	45	15	6

Vehicles equipped with compression +ignition engines with a capacity exceeding 2 000 cm³ must comply with the limit values corresponding to the 1 400 cm³ to 2 000 cm³ inclusive engine capacity category.

▼ **M4**

- 5.2.1.1.4.1. Nevertheless, for each of the pollutants referred to in 5.2.1.1.4, one of the three results obtained may exceed by not more than 10 % the limit prescribed in that section for the vehicle concerned, provided the arithmetical mean of the three results is below the prescribed limit. Where the prescribed limits are exceeded for more than one pollutant (i.e. carbon monoxide and the combined mass of hydrocarbons and nitrogen oxides ► **M5** and the mass of nitrogen oxides ◀) it is immaterial whether this occurs in the same test or in different tests⁽¹⁾.
- 5.2.1.1.4.2. The number of tests prescribed in 5.2.1.1.4 may, on the request of the manufacturer, be increased to 10 tests provided that the arithmetic mean (\bar{x}) of the three results performed for carbon monoxide and/or for the combined emissions of hydrocarbons and of oxides of nitrogen ► **M5** and the emissions of nitrogen oxides ◀ falls between 100 and 110 % of the limit. In this case, the decision, after testing, depends exclusively on the average results obtained from all 10 tests ($\bar{x} < L$).
- 5.2.1.1.5. The number of tests prescribed in 5.2.1.1.4 is reduced in the conditions hereinafter defined, where V_1 is the result of the first test and V_2 the result of the second test for each of the pollutants referred to in 5.2.1.1.4.
- 5.2.1.1.5.1. Only one test is performed if V_1 readings of carbon monoxide as well as the combined hydrocarbon and oxides of nitrogen ► **M5** and the emissions of nitrogen oxides ◀ reading are less than or equal to 0,70 L.
- 5.2.1.1.5.2. Only two tests are performed if the results of both the carbon monoxide and the combined value of hydrocarbons and oxides of nitrogen ► **M5** and the emissions of nitrogen oxides ◀ are $V_1 \leq 0,85$ L, and if, at the same time, one of these values is $V_1 > 0,70$ L. In addition, the V_2 readings of both the carbon monoxide emissions and the combined emissions of hydrocarbon and oxides of nitrogen ► **M5** and the emissions of nitrogen oxides ◀ must satisfy the requirement that $V_1 + V_2 \leq 1,70$ L, and $V_2 \leq L$.

⁽¹⁾ If one of the three results obtained of each of the pollutants exceeds by more than 10 % the limit prescribed in 5.2.1.1.4 for the vehicle concerned, the test may be continued as specified in 5.2.1.1.4.2.

▼M4

Figure 1

Flow sheet for the type-approval of the European test procedure (see 5.2)

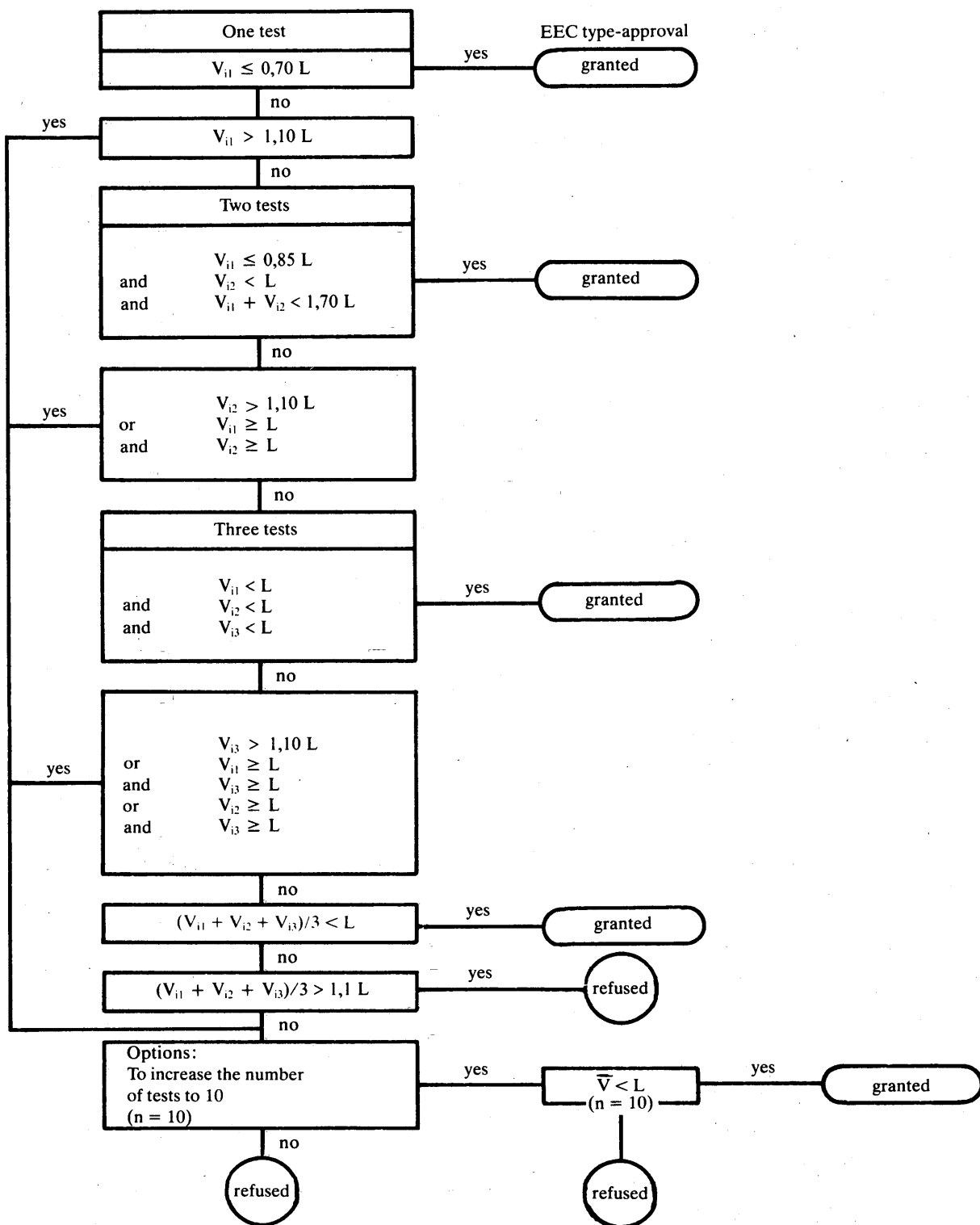

▼ **M4**

- 5.2.1.2. *Type II test* (carbon monoxide emission test at idling speed)
- 5.2.1.2.1. With the exception of vehicles powered by a compression-ignition engine, this test must be carried out on all vehicles referred to in 1.
- 5.2.1.2.2. The carbon monoxide content by volume of the exhaust gases emitted with the engine idling must not exceed 3,5 %. When a check is made in accordance with the requirements of Annex IV under operating conditions not in conformity with the standards recommended by the manufacturer (configuration of the adjustment components), the maximum content measured by volume must not exceed 4,5 %.
- 5.2.1.2.3. Conformity with the latter requirement is checked by means of a test carried out using the procedure described in Annex IV.
- 5.2.1.3. *Type III test* (verifying emissions of crankcase gases)
- 5.2.1.3.1. This test must be carried out on all vehicles referred to in 1 except those having compression-ignition engines.
- 5.2.1.3.2. The engine's crankcase ventilation system must not permit the emission of any of the crankcase gases into the atmosphere.
- 5.2.1.3.3. Conformity with the latter requirement is checked by means of a test carried out using the procedure described in Annex V.

6. EXTENSION OF EEC TYPE-APPROVAL

6.1. **Vehicle types of different reference masses**

- 6.1.1. Approval of a vehicle type may under the following conditions be extended to vehicle types which differ from the type approved only in respect of their reference mass.
- 6.1.1.1. Approval may be extended to vehicle types of a reference mass requiring merely the use of the next higher or next lower equivalent inertia.
- 6.1.1.2. If the reference mass of the vehicle type for which extension of the approval is requested requires the use of a flywheel of equivalent inertia higher than that used for the vehicle type already approved, extension of the approval is granted.
- 6.1.1.3. If the reference mass of the vehicle type for which extension of the approval is requested requires the use of a flywheel of equivalent inertia lower than that used for the vehicle type already approved, extension of the approval is granted if the masses of the pollutants obtained from the vehicle already approved are within the limits prescribed for the vehicle for which extension of the approval is requested.

6.2. **Vehicle types with different overall gear ratios**

- 6.2.1. Approval granted to a vehicle type may under the following conditions be extended to vehicle types differing from the type-approval only in respect of their overall transmission ratios:
- 6.2.1.1. For each of the transmission ratios used in the type I test, it is necessary to determine the proportion $E = \frac{V_2 - V_1}{V_1}$ where V_1 and V_2 are respectively the speed at 1 000 r/min of the engine of the vehicle type approved and the speed of the vehicle type for which extension of the approval is requested.
- 6.2.2. If for each gear ratio $E \leq 8 \%$, the extension is granted without repeating the type I tests;
- 6.2.3. If for at least one gear ratio $E > 8 \%$ and if for each gear ratio $E \leq 13 \%$, the type I tests are repeated, but may be performed in a laboratory chosen by the manufacturer subject to the approval of the authority granting type-approval. The report of the tests must be sent to the technical service responsible for the type-approval tests.

6.3. **Vehicle types of different reference masses and different overall transmission rating**

Approval granted to a vehicle type may be extended to vehicle types differing from the approved type only in respect of their reference mass and their overall transmission ratios, provided that all the conditions prescribed in 6.1 and 6.2 are fulfilled.

▼ **M4**6.4. **Note**

When a vehicle type has been approved in accordance with 6.1 to 6.3, such approval may not be extended to other vehicle types.

▼ **M5**6.5. **Positive-ignition engined vehicle types with different engine fuel requirements**

6.5.1. Approval shall be extended to vehicle types modified for engine fuel requirement purposes, provided the conditions set out in section 8.4.

6.6. **Vehicle types with automatic or continuously variable transmissions**

6.6.1. Approval granted to a vehicle type with a manual transmission may under the following conditions be extended to vehicle types with automatic or continuously variable transmissions:

6.6.1.1. the same basic forms of components and systems (other than the transmission) liable to affect the emissions of gaseous pollutants must be fitted and operational. However differences in detail to allow for the different operating characteristics of automatic or continuously variable transmissions are acceptable;

6.6.1.2. the vehicle type must have a reference mass within $\pm 5\%$ of the reference mass of the vehicle type with the manual transmission;

6.6.1.3. the vehicle type must be tested and satisfy the requirements of section 5 modified as follows:

the limit values for the nitrogen oxides are those resulting from the multiplication of the L3 values given in the table in section 5.2.1.1.4 by a factor of 1,3 and the limit values for the combined mass of the hydrocarbons and the nitrogen oxides are those resulting from the multiplication of the L2 values given in the table in section 5.2.1.1.4 by a factor of 1,2.

▼ **M4**

7. CONFORMITY OF PRODUCTION

7.1. As a general rule, conformity of production models, with regard to limitation of the emission of gaseous pollutants from the engine, is checked on the basis of the description in the Annex to the type-approval certificate set out in Annex VII and, where necessary, of all or some of the tests of types I, II and III described in 5.2.

7.1.1. Conformity of the vehicle in a type I test is checked as follows:

7.1.1.1. A vehicle is taken from the series and subjected to the test described in 5.2.1.1. However, the limits shown in 5.2.1.1.4 are replaced by the following:

▼ **M5**

Engine capacity	Mass of carbon monoxide	Combined mass of hydrocarbons and nitrogen oxides	Mass of nitrogen oxides
C (cm ³)	L1 (g/test)	L2 (g/test)	L3 (g/test)
C > 2 000	30	8,1	4,4
1 400 ≤ C ≤ 2 000	36	10	
C < 1 400	54	19	7,5

Vehicles equipped with compression +ignition engines with a capacity exceeding 2 000 cm³ must comply with the limit values corresponding to the 1 400 to 2 000 cm³ inclusive engine capacity category.

▼ **M4**

7.1.1.2. If the vehicle taken from the series does not satisfy the requirements of 7.1.1.1, the manufacturer may ask for measurements to be performed on a sample of vehicles taken from the series and including the vehicle originally taken. The manufacturer determines the size n of the sample. Vehicles other than the vehicle originally taken are subjected to a single type I test.

▼ M4

The result to be taken into consideration for the vehicle taken originally is the arithmetical mean of the three type I tests carried out on the vehicle. The arithmetic mean (\bar{x}) of the results obtained with the sample and the standard deviation $S^{(1)}$ must be determined for both the carbon monoxide emission and for the combined emissions of hydrocarbons and oxides of nitrogen. The production of the series is then deemed to conform if the following condition is met:

$$\bar{x} + k \cdot S \leq L$$

where

▼ M5

L is the limit value laid down in section 7.1.1.1 for the emissions of carbon monoxide, the combined emissions of hydrocarbons and nitrogen oxides and the emissions of nitrogen oxides;

▼ M4

k is a statistical factor depending on n and given in the following table:

n	2	3	4	5	6	7
k	0,973	0,613	0,489	0,421	0,376	0,342
n	8	9	10	11	12	13
k	0,317	0,296	0,279	0,265	0,253	0,242
n	14	15	16	17	18	19
k	0,233	0,224	0,216	0,210	0,203	0,195

$$\text{If } n \geq 20, \quad k = \frac{0,860}{\sqrt{n}}$$

- 7.1.2. In a type II or type III test carried out on a vehicle taken from the series, the conditions laid down in 5.2.1.2.2 and 5.2.1.3.2 must be complied with.
- 7.1.3. Notwithstanding the requirements of 3.1.1 of Annex III, the technical service responsible for verifying the conformity of production may, with the consent of the manufacturer, carry out tests of types I, II and III on vehicles which have been driven less than 3 000 km.

▼ M5

- 7.2. Where type approval is extended under the provisions of section 6.6 (automatic and continuously variable transmissions) the limit values for the nitrogen oxides are those resulting from the multiplication of the values L3 given in the table in section 7.1.1.1 by a factor of 1,3, and the limit values for the combined mass of the hydrocarbons and the nitrogen oxides are those resulting from the multiplication of the values L2 given in the table in section 7.1.1.1 by a factor of 1,2.

▼ M4

8. TRANSITIONAL PROVISIONS

▼ M5

- 8.1. For the type +approval and verification of conformity of
- vehicles other than those of category M₁,
 - passenger vehicles of category M₁ designed to carry more than six occupants including the driver or whose maximum mass exceeds 2 500 kg,
 - off +road vehicles as defined in Annex I to Directive 70/156/EEC as last amended by Directive 87/403/EEC⁽²⁾,

⁽¹⁾ $S^2 = \frac{\sum (x - \bar{x})^2}{n - 1}$, where x is any one of the individual results obtained with the sample n.

⁽²⁾ OJ No L 220, 8. 8. 1987, p. 44.

▼ **M5**

the limit values shown in the tables in sections 5.2.1.1.4 (type +approval) and 7.1.1.1 (conformity check) of Directive 70/220/EEC, as last amended by Directive 83/351/EEC, are applicable as from 1 October 1989 in the case of new vehicle types and from 1 October 1990 in the case of vehicles entering into service for the first time.

▼ **M4**

- 8.2. For the checking of production conformity of vehicles which were type-approved before 1 October 1984 as far as their emissions of pollutants are concerned, in accordance with the provisions of Directive 70/220/EEC, as amended by Directive 78/665/EEC, the provisions of the abovementioned Directive remain applicable until the Member States make use of Article 2 (3) of this Directive.

▼ **M5**

8.3. **Test equivalent to the type I test for verifying emissions after a cold start**

- 8.3.1. For the type +approval and verification of production of vehicles of category M_1 equipped with an engine whose capacity $\geq 1\,400\text{ cm}^3$, the technical service may, at the request of a manufacturer, carry out the equivalent test described in Annex IIIA (EPA cycle) instead of that described in 5.2.1.1. In that event, the following provisions apply:

- 8.3.1.1. For vehicle type +approval, the limit values specified in the table in section 5.2.1.1.4 are replaced by the following:

- mass of carbon monoxide (L1): 2,11 g/km,
- mass of hydrocarbons: 0,25 g/km,
- mass of nitrogen oxides (L3): 0,62 g/km.

These limit values are deemed to be met if they are not exceeded by the results of tests on a vehicle type when the masses of each pollutant are multiplied by the appropriate deterioration factor from the following table:

Emission control system	Deterioration factor		
	CO	HC	NO _x
1. Positive +ignition engine with oxidizing catalytic converter	1,2	1,3	1,0
2. Positive +ignition engine without catalytic converter	1,2	1,3	1,0
3. Positive +ignition engine with three +way catalytic converter	1,2	1,3	1,1
4. Compression +ignition engine	1,1	1,0	1,0

Where a manufacturer has obtained evidence of deterioration factors specific to the vehicle type using the certification procedures of Community export markets, those factors may be used as an alternative when establishing compliance with the limit values set out in this section.

- 8.3.1.2. For the verification of production conformity, vehicles may be taken from the series and subjected to the test described in Annex IIIA.

- 8.3.1.2.1. A failed vehicle is one whose test results, when adjusted by the deterioration factors established for the type approved in accordance with section 8.3.1 lead to one or more of the limit values in section 8.3.1.1 being exceeded.

- 8.3.1.2.2. The production of the series is deemed to conform or not to conform by testing vehicles comprising a test sample until a pass decision is reached for all limit values or a fail decision is reached for one limit value. A pass decision is reached when the cumulative number of failed vehicles as defined in section 8.3.1.2.1 for each limit value is less than or equal to the pass decision number appropriate to the cumulative number of vehicles tested. A fail decision is reached when the cumulative number of failed vehicles for one limit value is greater than or equal to the fail decision number appropriate to the cumulative number of vehicles tested.

Once a pass decision has been made for a particular limit value the number of vehicles whose final deteriorated test results exceed that

▼ M5

limit value must not be considered any further for the purposes of checking conformity of production.

The pass and fail decision numbers associated with the cumulative number of vehicles tested are given in the following table:

Cumulative number of vehicles tested	Pass decision (number of failures)	Fail decision (number of failures)
1	(¹)	(²)
2	(¹)	(²)
3	(¹)	(²)
4	(¹)	(²)
5	0	(²)
6	0	6
7	1	7
8	2	8
9	2	8
10	3	9
11	3	9
12	4	10
13	4	10
14	5	11
15	5	11
16	6	12
17	6	12
18	7	13
19	7	13
20	8	14
21	8	14
22	9	15
23	9	15
24	10	16
25	11	16
26	11	17
27	12	17
28	12	18
29	13	19
30	13	19
31	14	20
32	14	20
33	15	21
34	15	21
35	16	22
36	16	22
37	17	23
38	17	23
39	18	24
40	18	24
41	19	25
42	19	26
43	20	26
44	21	27
45	21	27
46	22	28
47	22	28
48	23	29
49	23	29
50	24	30
51	24	30
52	25	31
53	25	31
54	26	32
55	26	32
56	27	33
57	27	33
58	28	33
59	28	33

▼ M5

Cumulative number of vehicles tested	Pass decision (number of failures)	Fail decision (number of failures)
60	32	33

(¹) Series not able to pass at this stage.

(²) Series not able to fail at this stage.

- 8.3.1.3. Manufacturers of vehicles in possession of certificates issued by government authorities in Community export markets incorporating results of tests equivalent to those set out in Annex IIIA to this Directive may present such results.
- 8.4. For the extension of EEC type +approval to vehicles approved in accordance with the provisions of Directive 70/220/EEC, as last amended by Directive 83/351/EEC, but modified to satisfy the engine fuel requirements of this Directive, the manufacturers are to certify that:
- 8.4.1. the vehicle type conforms with the requirement of section 5.1.2 regarding engine fuel requirements,
- and
- 8.4.2. the vehicle continues to meet the production conformity limits in accordance with Directive 70/220/EEC, as last amended by Directive 83/351/EEC.

▼M5

Sampling plan for use with Annex IIIA test

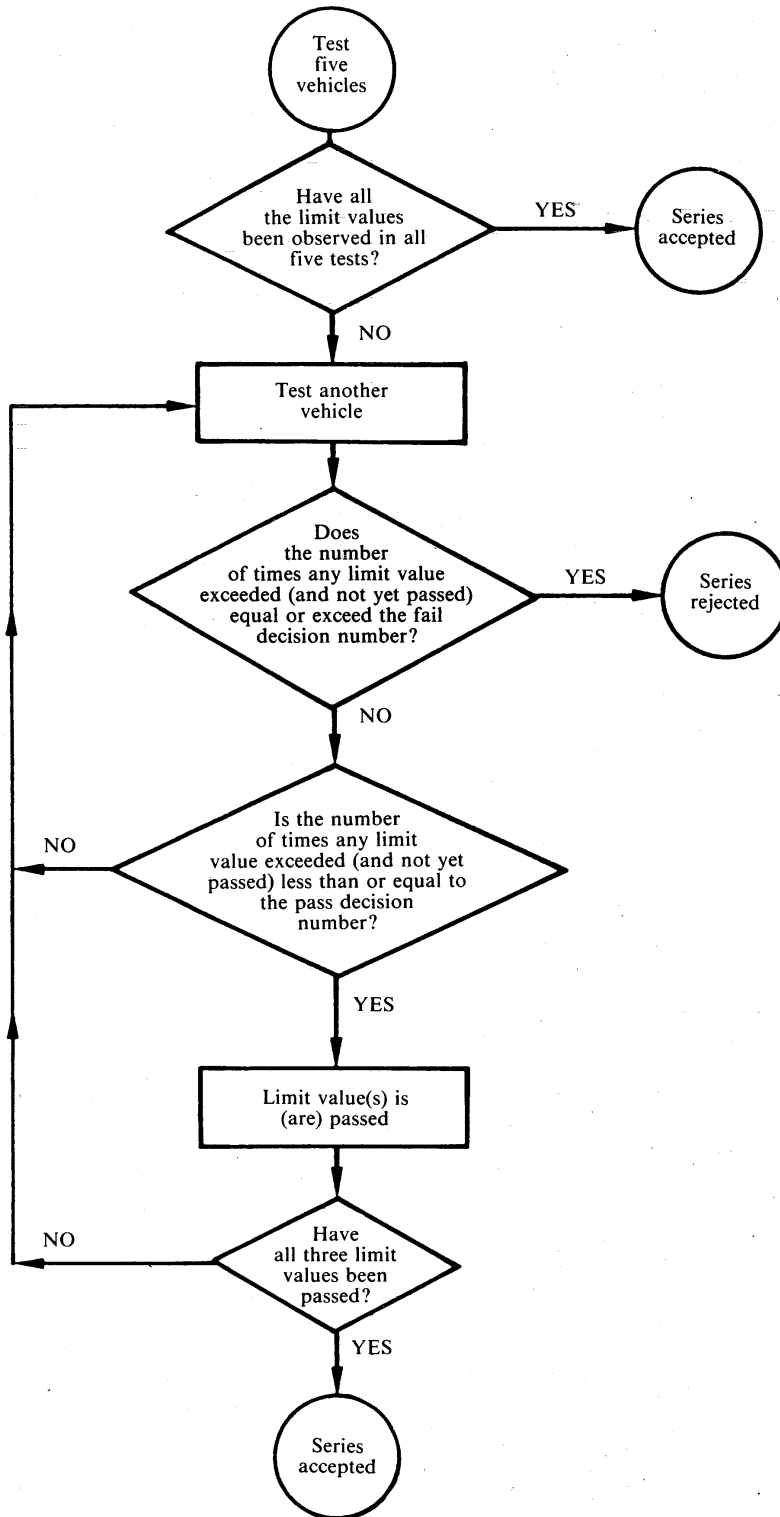

▼ M5

Sampling plan for use with Annex IIIA test

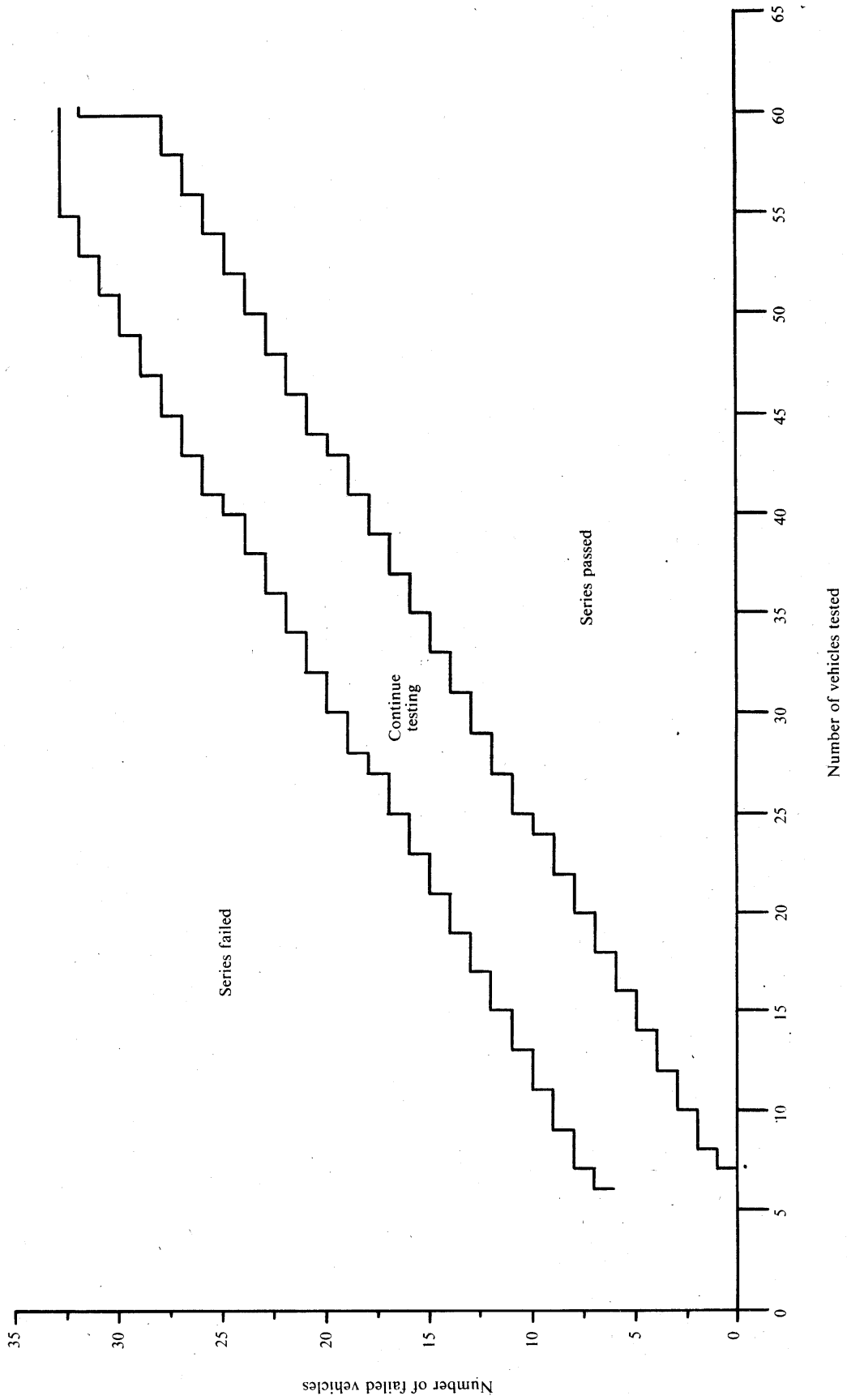

▼ **M4**

ANNEX II

ESSENTIAL CHARACTERISTICS OF THE ENGINE AND INFORMATION CONCERNING THE CONDUCT OF TEST (1)

1. **Description of engine**
 - 1.1. Make:
 - 1.2. Type:
 - 1.3. Working principle: positive ignition/compression ignition, four stroke/two stroke (2):
 - 1.4. Bore: mm^{▶(4)}◀
 - 1.5. Stroke: mm^{▶(4)}◀
 - 1.6. Number and layout of cylinders and firing order:
 - 1.7. Cylinder capacity: cm³ ▶⁽⁵⁾◀
 - 1.8. Compression ratio (2):
 - 1.9. Drawings of combustion chamber and piston crown:
 - 1.10. Cooling system: liquid/air cooling (2):
 - 1.11. Supercharger: yes/no (2) Description of the system:
 - 1.12. *Intake system*
 - Intake manifold: Description:
 - Air filter: Make: Type:
 - Intake silencer: Make: Type:
 - 1.13. Device for recycling crankcase gases (description and diagrams):
2. **Additional anti-pollution devices (if any, and if not covered by another heading)**
 - Description and diagrams:
3. **Air intake and fuel feed**
 - 3.1. Description and diagrams of inlet pipes and their accessories (dash-pot, heating device, additional air intakes, etc.):
 - 3.2. Fuel feed
 - 3.2.1. By carburettor(s) (2): Number:
 - 3.2.1.1. Make:

(1) In the case of non-conventional engines and systems, particulars equivalent to those referred to here shall be supplied by the manufacturer.

(2) Delete as inapplicable.

(3) Specify the tolerance.

▶⁽⁴⁾ This figure must be rounded off to the nearest tenth of a millimetre.

(5) This value must be calculated with $\pi = 3,1416$ and rounded off to the nearest cm³. ◀

▼ **M4**

- 3.2.1.2. Type:
 - 3.2.1.3. Adjustments ⁽¹⁾
 - 3.2.1.3.1. Jets:
 - 3.2.1.3.2. Venturis:
 - 3.2.1.3.3. Float-chamber level:
 - 3.2.1.3.4. Mass of float:
 - 3.2.1.3.5. Float needle:
- } or Curve of fuel delivery plotted against air flow, and settings required to keep to the curve ⁽¹⁾⁽²⁾
- 3.2.1.4. Manual/automatic choke ⁽²⁾:
 Closure setting ⁽¹⁾:
 - 3.2.1.5. Feed pump
 Pressure ⁽¹⁾: or characteristic diagram ⁽¹⁾:
 - 3.2.2. By fuel injection ⁽²⁾ system description
 Working principle: Intake manifold/direct injection
 injection prechamber/swirl chamber ⁽²⁾:
 - 3.2.2.1. Fuel pump:
 - 3.2.2.1.1. Make:
 - 3.2.2.1.2. Type:
 - 3.2.2.1.3. Delivery: mm³ per stroke at a pump speed of r/min ⁽¹⁾⁽²⁾
 or, alternatively, a characteristic diagram ⁽¹⁾⁽²⁾:
 Calibration procedure: test bench/engine ⁽²⁾
 - 3.2.2.1.4. Injection timing:
 - 3.2.2.1.5. Injection curve:
 - 3.2.2.2. Injector nozzle:
 - 3.2.2.3. Governor:
 - 3.2.2.3.1. Make:
 - 3.2.2.3.2. Type:
 - 3.2.2.3.3. Cut-off point under load min⁻¹:
 - 3.2.2.3.4. Maximum speed without load min⁻¹:
 - 3.2.2.3.5. Idle speed:
 - 3.2.2.4. Cold start device:
 - 3.2.2.4.1. Make:
 - 3.2.2.4.2. Type:

⁽¹⁾ Specify the tolerance.
⁽²⁾ Delete as inapplicable.

▼ **M4**

- 3.2.2.4.3. System description:
- 3.2.2.5. Starting aid:
- 3.2.2.5.1. Make:
- 3.2.2.5.2. Type:
- 3.2.2.5.3. System description:
- 4. Valve timing or equivalent data**
- 4.1. Maximum lift of valves, angles of opening and closing, or timing details of alternative distribution systems, in relation to top dead centre:
- 4.2. Reference and/or setting ranges ⁽¹⁾:
- 5. Ignition**
- 5.1. Ignition system type:
- 5.1.1. Make:
- 5.1.2. Type:
- 5.1.3. Ignition advance curve ⁽²⁾:
- 5.1.4. Ignition timing ⁽²⁾:
- 5.1.5. Contact-point gap ⁽²⁾ and dwell-angle ⁽¹⁾⁽²⁾:
- 6. Exhaust system**
- 6.1. Description and diagrams:
- 7. Additional information on test conditions**
- 7.1. *Sparking plugs*
- 7.1.1. Make:
- 7.1.2. Type:
- 7.1.3. Spark-gap setting:
- 7.2. *Ignition coil*
- 7.2.1. Make:
- 7.2.2. Type:

⁽¹⁾ Delete as inapplicable.

⁽²⁾ Specify the tolerance.

▼ **M4**7.3. *Ignition condenser*

7.3.1. Make:

7.3.2. Type:

▶⁽¹⁾ **Information to be supplied for the tests provided for in Annex IIIA**

Gear change-over point (for first to second, etc.):

Method of cold starting:

8. **Engine performance (declared by manufacturer)**8.1. Idle r/min ⁽¹⁾:

8.2. Carbon monoxide content by volume in the exhaust gas with the engine idling — % (manufacturer's standard):

8.3. R/min at maximum power ⁽¹⁾:

8.4. Maximum power: kW (according to the method described in Annex I to Directive 80/1269/EEC)

9. **Lubricant used**

9.1. Make:

9.2. Type:

⁽¹⁾ Specify the tolerance.

▼ **M4***ANNEX III***TYPE I TEST****(Verifying the average emission of pollutants in a congested urban area after a cold start)****1. INTRODUCTION**

This Annex describes the procedure for the type I test defined in 5.2.1.1 of Annex I.

2. OPERATING CYCLE ON THE CHASSIS DYNAMOMETER**2.1. Description of the cycle**

The operating cycle on the chassis dynamometer is that indicated in the following table and depicted in the graph in Appendix 1. The breakdown by operations is also given in the table in the said Appendix.

2.2. General conditions under which the cycle is carried out

Preliminary testing cycles must be carried out if necessary to determine how best to actuate the accelerator and brake controls so as to achieve a cycle approximating to the theoretical cycle within the prescribed limits.

2.3. Use of the gearbox

2.3.1. If the maximum speed which can be attained in first gear is below 15 km/h, the second, third and fourth gears are used. The second, third and fourth gears may also be used when the driving instructions recommend starting in second gear on level ground, or when first gear is therein defined as a gear reserved for cross-country driving, crawling or towing.

2.3.2. Vehicles equipped with semi-automatic-shift gearboxes are tested by using the gears normally employed for driving, and the gear shift is used in accordance with the manufacturer's instructions.

2.3.3. Vehicles equipped with automatic-shift gearboxes are tested with the highest gear ('Drive') engaged. The accelerator must be used in such a way as to obtain the steadiest acceleration possible, enabling the various gears to be engaged in the normal order. Furthermore, the gear-change points shown in Appendix 1 to this Annex do not apply; acceleration must continue throughout the period represented by the straight line connecting the end of each period of idling with the beginning of the next following period of steady speed. The tolerances given in 2.4 apply.

2.3.4. Vehicles equipped with an overdrive which the driver can actuate are tested with the overdrive out of action.

2.4. Tolerances

2.4.1. A tolerance of ± 1 km/h is allowed between the indicated speed and the theoretical speed during acceleration, during steady speed, and during deceleration when the vehicle's brakes are used. If the vehicle decelerates more rapidly without the use of the brakes, only the requirements of 6.5.3 apply. Speed tolerances greater than those prescribed are accepted during phase changes provided that the tolerances are never exceeded for more than 0,5 s on any one occasion.

2.4.2. The time tolerances are $\pm 0,5$ s. The above tolerances apply equally at the beginning and at the end of each gear-changing period⁽¹⁾.

⁽¹⁾ It should be noted that the time of two seconds allowed includes the time for changing gear and, if necessary, a certain amount of latitude to catch up with the cycle.

Operating cycle on the chassis dynamometer

No of operation	Operation	Phase	Acceleration (m/s ²)	Speed (km/h)	Duration of each		Cumulative time (s)	Gear to be used in the case of a manual gearbox
					Operation (s)	Phase (s)		
1	Idling	1			11	11	11	6 s PM + 5 s K ₁ (*)
2	Acceleration	2	1,04	0 — 15	4	4	15	1
3	Steady speed	3		15	8	8	23	1
4	Deceleration	4	- 0,69	15 — 10	2	2	25	1
5	Deceleration, clutch disengaged	5	- 0,92	10 — 0	3	3	28	K ₁ (*)
6	Idling	6			21	21	49	16 s PM + 5 s K ₁ (*)
7	Acceleration	7	0,83	0 — 15	5	5	54	1
8	Gear change	8			2	2	56	
9	Acceleration	9	0,94	15 — 32	5	5	61	2
10	Steady speed	10		32	24	24	85	2
11	Deceleration	11	- 0,75	32 — 10	8	8	93	2
12	Deceleration, clutch disengaged	12	- 0,92	10 — 0	3	3	96	K ₂ (*)
13	Idling	13			21	21	117	16 s PM + 5 s K ₁ (*)
14	Acceleration	14	0,83	0 — 15	5	5	122	1
15	Gear change	15			2	2	124	
16	Acceleration	16	0,62	15 — 35	9	9	133	2
17	Gear change	17			2	2	135	
18	Acceleration	18	0,52	35 — 50	8	8	143	3
19	Steady speed	19		50	12	12	155	3
20	Deceleration	20	- 0,52	50 — 35	8	8	163	3
21	Steady speed	21		35	13	13	176	3
22	Gear change	22			2	2	178	
23	Deceleration	23	- 0,86	32 — 10	7	7	185	2
24	Deceleration, clutch disengaged	24	- 0,92	10 — 0	3	3	188	K ₂ (*)
25	Idling	25			7	7	195	7 s PM (*)

(*) PM = gearbox in neutral, clutch engaged.
 K₁, K₂ = first or second gear engaged, clutch disengaged.

▼ M4

- 2.4.3. The speed and time tolerances are combined as indicated in Appendix 1 to this Annex.
3. VEHICLE AND FUEL
- 3.1. **Test vehicle**
- 3.1.1. The vehicle must be presented in good mechanical condition. It must have been run-in and driven at least 3 000 km before the test.
- 3.1.2. The exhaust device must not exhibit any leak likely to reduce the quantity of gas collected, which quantity must be that emerging from the engine.
- 3.1.3. The tightness of the intake system may be checked to ensure that carburation is not affected by an accidental intake of air.
- 3.1.4. The settings of the engine and of the vehicle's controls must be those prescribed by the manufacturer. This requirement also applies, in particular, to the settings for idling (rotation speed and carbon monoxide content of the exhaust gases), for the cold start device and for the exhaust gas pollutant emission control system.
- 3.1.5. The vehicle to be tested, or an equivalent vehicle, must be fitted, if necessary, with a device to permit the measurement of the characteristic parameters necessary for chassis dynamometer setting, in conformity with 4.1.1.
- 3.1.6. The technical service may verify that the vehicle's performance conforms to that stated by the manufacturer, that it can be used for normal driving and, more particularly, that it is capable of starting when cold and when hot.

▼ M5**▼ M4**

- 3.2. **Fuel**
- The appropriate reference fuel as defined in Annex VI must be used for testing.
4. TEST EQUIPMENT
- 4.1. **Chassis dynamometer**
- 4.1.1. The dynamometer must be capable of simulating road load within one of the following classifications:
- dynamometer with fixed load curve, i.e. a dynamometer whose physical characteristics provide a fixed load curve shape,
 - dynamometer with adjustable load curve, i.e. a dynamometer with at least two road load parameters that can be adjusted to shape the load curve.
- 4.1.2. The setting of the dynamometer must not be affected by the lapse of time. It must not produce any vibrations perceptible to the vehicle and likely to impair the vehicle's normal operations.
- 4.1.3. It must be equipped with means to simulate inertia and load. These simulators are connected to the front roller in the case of a two-roller dynamometer.
- 4.1.4. *Accuracy*
- 4.1.4.1. It must be possible to measure and read the indicated load to an accuracy of $\pm 5\%$.
- 4.1.4.2. In the case of a dynamometer with a fixed load curve the accuracy of the load setting at 50 km/h must be $\pm 5\%$. In the case of a dynamometer with adjustable load curve, the accuracy of matching dynamometer load to road load must be 5 % at 30, 40, and 50 km/h and 10 % at 20 km/h. Below this, dynamometer absorption must be positive.
- 4.1.4.3. The total inertia of the rotating parts (including the simulated inertia where applicable) must be known and must be within ± 20 kg of the inertia class for the test.

▼ **M4**

- 4.1.4.4. The speed of the vehicle must be measured by the speed of rotation of the roller (the front roller in the case of a two roller dynamometer). It must be measured with an accuracy of ± 1 km/h at speeds above 10 km/h.
- 4.1.5. *Load and inertia setting*
- 4.1.5.1. Dynamometer with fixed load curve: the load simulator must be adjusted to absorb the power exerted on the driving wheels at a steady speed of 50 km/h. The means by which this load is determined and set are described in Appendix 3.
- 4.1.5.2. Dynamometer with adjustable load curve: the load simulator must be adjusted in order to absorb the power exerted on the driving wheels at steady speeds of 20, 30, 40 and 50 km/h. The means by which these loads are determined and set are described in Appendix 3.
- 4.1.5.3. Inertia
- Dynamometers with electrical inertia simulation must be demonstrated to be equivalent to mechanical inertia systems. The means by which equivalence is established is described in Appendix 4.
- 4.2. **Exhaust gas-sampling system**
- 4.2.1. The exhaust gas-sampling system is designed to enable the measurements of the true mass emission of pollutants by the vehicle exhaust. The system to be used is the constant volume sampler (CVS) system. This requires that the vehicle exhaust be continuously diluted with ambient air under controlled conditions. In the constant volume sampler concept of measuring mass emissions, two conditions must be satisfied, the total volume of the mixture of exhaust and dilution air must be measured and a continuously proportional sample of the volume must be collected for analysis. Mass emissions are determined from the sample concentrations corrected for the pollutant content of the ambient air, and totalized flow over the test period.
- 4.2.2. The flow through the system must be sufficient to eliminate water condensation at all conditions which may occur during a test, as defined in Appendix 5.
- 4.2.3. Figure 1 gives a schematic diagram of the general concept. Appendix 5 gives examples of three types of constant volume sampler system which satisfy the requirements set out in this Annex.
- 4.2.4. The gas and air mixture must be homogeneous at point S2 of the sampling probe.
- 4.2.5. The probe must extract a true sample of the diluted exhaust gases.
- 4.2.6. The system must be free of gas leaks. The design and materials must be such that the system does not influence the pollutant concentration in the diluted exhaust gas. Should any component (heat exchanger, blower, etc.) change the concentration of any pollutant gas in the diluted gas, the sampling for that pollutant must be carried out before that component if the problem cannot be corrected.
- 4.2.7. If the vehicle being tested is equipped with an exhaust pipe comprising several branches, the connecting tubes must be connected as near as possible to the vehicle.
- 4.2.8. Static pressure variations at the tailpipe(s) of the vehicle must remain within $\pm 1,25$ kPa of the static pressure variations measured during the dynamometer driving cycle with no connection to the tailpipe(s). Sampling systems capable of maintaining the static pressure to within $\pm 0,25$ kPa are used if a written request from a manufacturer to the competent authority issuing the approval substantiates the need for the narrower tolerance. The back-pressure must be measured in the exhaust pipe, as near as possible to its end or in an extension having the same diameter.

▼ M4

Figure 1

Diagram of exhaust-gas sampling system

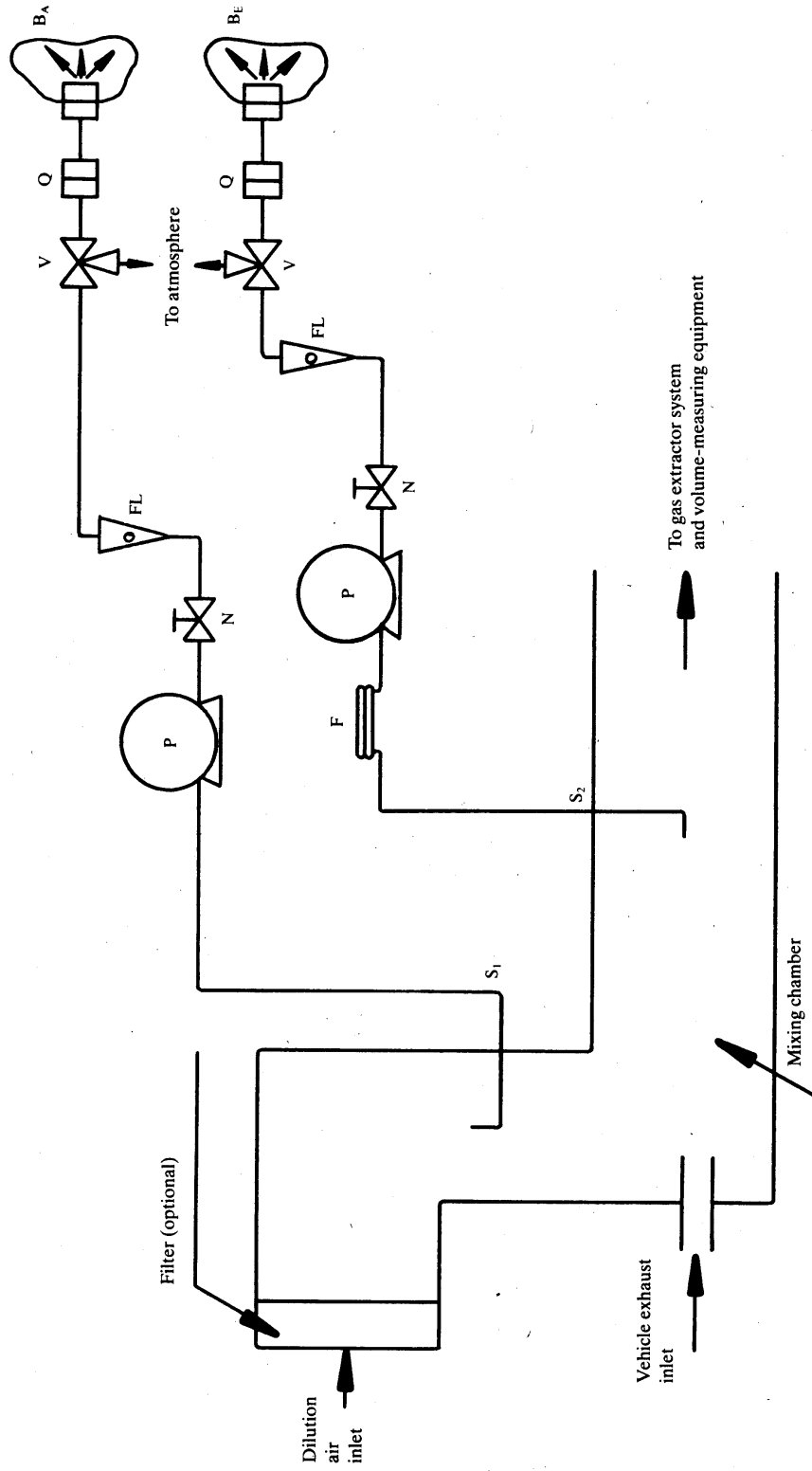

▼ **M4**

- 4.2.9. The various valves used to direct the exhaust gases must be of a quick-adjustment, quick-acting type.
- 4.2.10. The gas samples are collected in sample bags of adequate capacity. These bags must be made of such materials as will not change the pollutant gas by more than $\pm 2\%$ after 20 minutes of storage.

4.3. Analytical equipment4.3.1. *Requirements*

- 4.3.1.1. Pollutant gases must be analyzed with the following instruments:

Carbon monoxide (CO) and carbon dioxide (CO₂) analysis:

The carbon monoxide and carbon dioxide analyzers must be of the non-dispersive infra-red (NDIR) absorption type.

Hydrocarbons (HC) analysis — spark-ignition engines:

The hydrocarbons analyzer must be of the flame ionization (FID) type calibrated with propane gas expressed equivalent to carbon atoms (C₁).

Hydrocarbons (HC) analysis — compression-ignition engines:

The hydrocarbons analyzer must be of the flame ionization type with detector, valves, pipework, etc. heated to 190 ± 10 °C (HFID). It must be calibrated with propane gas expressed equivalent to carbon atoms (C₁).

Nitrogen oxide (NO_x) analysis:

The nitrogen oxide analyzer must be either of the chemiluminescent (CLA) or of the non-dispersive ultra-violet resonance absorption (NDUVR) type, both with an NO_x — NO converter.

4.3.1.2. Accuracy

The analyzers must have a measuring range compatible with the accuracy required to measure the concentrations of the exhaust gas sample pollutants.

Measurement error must not exceed $\pm 3\%$, disregarding the true value of the calibration gases.

For concentrations of less than 100 ppm the measurement error must not exceed ± 3 ppm. The ambient air sample must be measured on the same analyzer and range as the corresponding diluted exhaust sample.

4.3.1.3. Ice-trap

No gas drying device must be used before the analyzers unless shown to have no effect on the pollutant content of the gas stream.

4.3.2. *Particular requirements for compression-ignition engines*

A heated sample line for a continuous HC-analysis with the flame ionization detector (HFID), including recorder (R) must be used. The average concentration of the measured hydrocarbons must be determined by integration. Throughout the test, the temperature of the heated sample line must be controlled at 190 ± 10 °C. The heated sampling line must be fitted with a heated filter (F_H) 99 % efficient with particle $\geq 0,3$ μm to extract any solid particles from the continuous flow of gas required for analysis. The sampling system response time (from the probe to the analyzer inlet) must be no more than four seconds.

The HFID must be used with a constant flow (heat exchanger) system to ensure a representative sample, unless compensation for varying CFV or CFO flows is made.

4.3.3. *Calibration*

Each analyzer must be calibrated as often as necessary and in any case in the month before type-approval testing and at least once every six months for verifying conformity of production. The calibration method to be used is described in Appendix 6 for the analyzers referred to in 4.3.1.

4.4. Volume measurement

- 4.4.1. The method of measuring total dilute exhaust volume incorporated in the constant volume sampler must be such that measurement is accurate to $\pm 2\%$.

▼ **M4**4.4.2. *Constant volume sampler calibration*

The constant volume sampler system volume measurement device must be calibrated by a method sufficient to ensure the prescribed accuracy and at a frequency sufficient to maintain such accuracy.

An example of a calibration procedure which will give the required accuracy is given in Appendix 6. The method utilizes a flow metering device which is dynamic and suitable for the high flow-rate encountered in constant volume sampler testing. The device must be of certified accuracy in conformity with an approved national or international standard.

4.5. **Gases**4.5.1. *Pure gases*

The following pure gases must be available, if necessary, for calibration and operation:

- purified nitrogen (purity ≤ 1 ppm C, ≤ 1 ppm CO, ≤ 400 ppm CO₂, $\leq 0,1$ ppm NO),
- purified synthetic air (purity ≤ 1 ppm C, ≤ 1 ppm CO, ≤ 400 ppm CO₂, $\leq 0,1$ ppm NO); oxygen content between 18 and 21 % vol,
- purified oxygen (purity $\leq 99,5$ % vol O₂),
- purified hydrogen (and mixture containing hydrogen) (purity ≤ 1 ppm C, ≤ 400 ppm CO₂).

4.5.2. *Calibration and span gases*

Gases having the following chemical compositions must be available: mixtures of:

- C₃H₈ and purified synthetic air (4.5.1),
- CO and purified nitrogen,
- CO₂ and purified nitrogen,
- NO and purified nitrogen.

(The amount of NO₂ contained in this calibration gas must not exceed 5 % of the NO content.)

The true concentration of a calibration gas must be within ± 2 % of the stated figure.

The concentrations specified in Appendix 6 may also be obtained by means of a gas divider, diluting with purified N₂ or with purified synthetic air. The accuracy of the mixing device must be such that the concentrations of the diluted calibration gases may be determined to within ± 2 %.

4.6. **Additional equipment**4.6.1. *Temperatures*

The temperatures indicated in Appendix 8 are measured with an accuracy of $\pm 1,5$ °C.

4.6.2. *Pressure*

The atmospheric pressure must be measurable to within $\pm 0,1$ kPa.

4.6.3. *Absolute humidity*

The absolute humidity (H) must be measurable to within ± 5 %.

4.7. The exhaust gas-sampling system must be verified by the method described in 3 of Appendix 7. The maximum permissible deviation between the quantity of gas introduced and the quantity of gas measured is 5 %.

5. **PREPARING THE TEST**5.1. **Adjustment of inertia simulators to the vehicle's translatory inertias**

An inertia simulator is used enabling a total inertia of the rotating masses to be obtained proportional to the reference mass within the following limits:

▼ **M4**

Reference mass of vehicle RW (kg)	Equivalent inertias I (kg)
$RW \leq 750$	680
$750 < RW \leq 850$	800
$850 < RW \leq 1\ 020$	910
$1\ 020 < RW \leq 1\ 250$	1 130
$1\ 250 < RW \leq 1\ 470$	1 360
$1\ 470 < RW \leq 1\ 700$	1 590
$1\ 700 < RW \leq 1\ 930$	1 810
$1\ 930 < RW \leq 2\ 150$	2 040
$2\ 150 < RW \leq 2\ 380$	2 270
$2\ 380 < RW \leq 2\ 610$	2 270
$2\ 610 < RW$	2 270

5.2. **Setting of dynamometer**

The load is adjusted according to methods described in 4.1.4.

The method used and the values obtained (equivalent inertia — characteristic adjustment parameter) must be recorded in the test report.

5.3. **Conditioning of vehicle**

- 5.3.1. Before the test, the vehicle must be kept in a room in which the temperature remains relatively constant between 20 and 30 °C. This conditioning must be carried out for at least six hours and continue until the engine oil temperature and coolant, if any, are within ± 2 °C of the temperature of the room.

If the manufacturer so requests, the test must be carried out not later than 30 hours after the vehicle has been run at its normal temperature.

- 5.3.2. The tyre pressures must be the same as that specified by the manufacturer and used for the preliminary road test for brake adjustment. The tyre pressures may be increased by up to 50 % from the manufacturer's recommended setting in the case of a two-roller dynamometer. The actual pressure used must be recorded in the test report.

6. **PROCEDURE FOR BENCH TESTS**6.1. **Special conditions for carrying out the cycle**

- 6.1.1. During the test, the test cell temperature must be between 20 and 30 °C. The absolute humidity (H) of either the air in the test cell or the intake air of the engine must be such that:

$$5,5 \leq H \leq 12,2 \text{ g H}_2\text{O/kg dry air}$$

- 6.1.2. The vehicle must be approximately horizontal during the test so as to avoid any abnormal distribution of the fuel.
- 6.1.3. The test must be carried out with the bonnet raised unless this is technically impossible. An auxiliary ventilating device acting on the radiator (water-cooling) or on the air intake (air-cooling) may be used if necessary to keep the engine temperature normal.
- 6.1.4. During the test the speed is recorded against time so that the correctness of the cycles performed can be assessed.

6.2. **Starting-up the engine**

- 6.2.1. The engine must be started up by means of the devices provided for this purpose according to the manufacturer's instructions, as incorporated in the drivers' handbook of production vehicles.
- 6.2.2. The engine must be kept idling for a period of 40 seconds. The first cycle must begin at the end of the aforesaid period of 40 seconds at idle.

▼ **M4****6.3. Idling****6.3.1. Manual-shift or semi-automatic gearbox**

- 6.3.1.1. During periods of idling the clutch must be engaged and the gears in neutral.
- 6.3.1.2. To enable the accelerations to be performed according to the normal cycle the vehicle must be placed in first gear, with the clutch disengaged, five seconds before the acceleration following the idling period considered.
- 6.3.1.3. The first idling period at the beginning of the cycle consists of six seconds of idling in neutral with the clutch engaged and five seconds in first gear with the clutch disengaged.
- 6.3.1.4. For the idling periods during each cycle the corresponding times are 16 seconds in neutral and five seconds in first gear with the clutch disengaged.
- 6.3.1.5. The idling period between two successive cycles comprises 13 seconds in neutral with the clutch engaged.

6.3.2. Automatic-shift gearbox

After initial engagement the selector must not be operated at any time during the test except as in the case specified in 6.4.3.

6.4. Accelerations

- 6.4.1. Accelerations must be so performed that the rate of acceleration is as constant as possible throughout the phase.
- 6.4.2. If an acceleration cannot be carried out in the prescribed time, the extra time required is, if possible, deducted from the time allowed for changing gear, but otherwise from the subsequent steady-speed period.
- 6.4.3. *Automatic-shift gearboxes*

If an acceleration cannot be carried out in the prescribed time, the gear selector is operated in accordance with requirements for manual-shift gearboxes.

6.5. Deceleration

- 6.5.1. All decelerations are effected by removing the foot completely from the accelerator, the clutch remaining engaged. The clutch is disengaged, without use of the gear lever, at a speed of 10 km/h.
- 6.5.2. If the period of deceleration is longer than that prescribed for the corresponding phase, the vehicle's brakes are used to enable the timing of the cycle to be complied with.
- 6.5.3. If the period of deceleration is shorter than that prescribed for the corresponding phase, the timing of the theoretical cycle is restored by constant speed or idling period merging into the following operation.
- 6.5.4. At the end of the deceleration period (halt of the vehicle on the rollers) the gears are placed in neutral and the clutch engaged.

6.6. Steady speeds

- 6.6.1. 'Pumping' or the closing of the throttle must be avoided when passing from acceleration to the following steady speed.
- 6.6.2. Periods of constant speed are achieved by keeping the accelerator position fixed.

7. PROCEDURE FOR SAMPLING AND ANALYSIS**7.1. Sampling**

Sampling begins at the beginning of the test cycle as defined in 6.2.2 and ends at the end of the idling period after the fourth cycle.

7.2. Analysis

- 7.2.1. The exhaust gases contained in the bag must be analyzed as soon as possible and in any event not later than 20 minutes after the end of the test cycle.

▼ M4

- 7.2.2. Prior to each sample analysis the analyzer range to be used for each pollutant must be set to zero with the appropriate zero gas.
- 7.2.3. The analyzers are then set to the calibration curves by means of span gases of nominal concentrations of 70 to 100 % of the range.
- 7.2.4. The analyzers' zeros are then rechecked. If the reading differs by more than 2 % of range from that set in 7.2.2, the procedure is repeated.
- 7.2.5. The samples are then analyzed.
- 7.2.6. After the analysis, zero and span points are rechecked using the same gases. If these rechecks are within 2 % of those in 7.2.3, the analysis is considered acceptable.
- 7.2.7. At all points in this section the flow-rates and pressures of the various gases must be the same as those used during calibration of the analyzers.
- 7.2.8. The figure adopted for the content of the gases in each of the pollutants measured is that read off after stabilization on the measuring device. Hydrocarbon mass emissions of compression-ignition engines are calculated from the integrated HFID reading, corrected for varying flow if necessary as shown in Appendix 5.

8. DETERMINATION OF THE QUANTITY OF GASEOUS POLLUTANTS EMITTED

8.1. The volume considered

The volume to be considered must be corrected to conform to the conditions of 101,33 kPa and 273,2 K.

8.2. Total mass of gaseous pollutants emitted

The mass M of each pollutant emitted by the vehicle during the test is determined by obtaining the product of the voluminal concentration and the volume of the gas in question, with due regard for the following densities at the abovementioned reference condition:

- in the case of carbon monoxide (CO) $d = 1,25$ grams per litre,
- in the case of hydrocarbons ($\text{CH}_{1,85}$) $d = 0,619$ grams per litre,
- in the case of nitrogen oxides (NO_2) $d = 2,05$ grams per litre.

Appendix 8 gives calculations relative to the various methods, followed by examples, to determine the quantity of gaseous pollutants emitted.

▼ **M4***APPENDIX I***BREAKDOWN OF THE OPERATING CYCLE USED FOR THE TYPE I TEST****1. Breakdown by phases**

	Time	%	
Idling:	60 s	30,8	}
Idling, vehicle moving, clutch engaged on one combination:	9 s	4,6	
Gear-shift:	8 s	4,1	
Accelerations:	36 s	18,5	
Steady-speed periods:	57 s	29,2	
Decelerations:	25 s	12,8	
	195 s	100	

2. Breakdown by use of gears

Idling:	60 s	30,8	}	35,4
Idling, vehicle moving, clutch engaged on one combination:	9 s	4,6		
Gear-shift:	8 s	4,1		
First gear:	24 s	12,3		
Second gear	53 s	27,2		
Third gear:	41 s	21		
	195 s	100		

Average speed during test: 19 km/h.

Effective running time: 195 s.

Theoretical distance covered per cycle: 1,013 km.

Equivalent distance for the test (4 cycles): 4,052 km

▼ M4

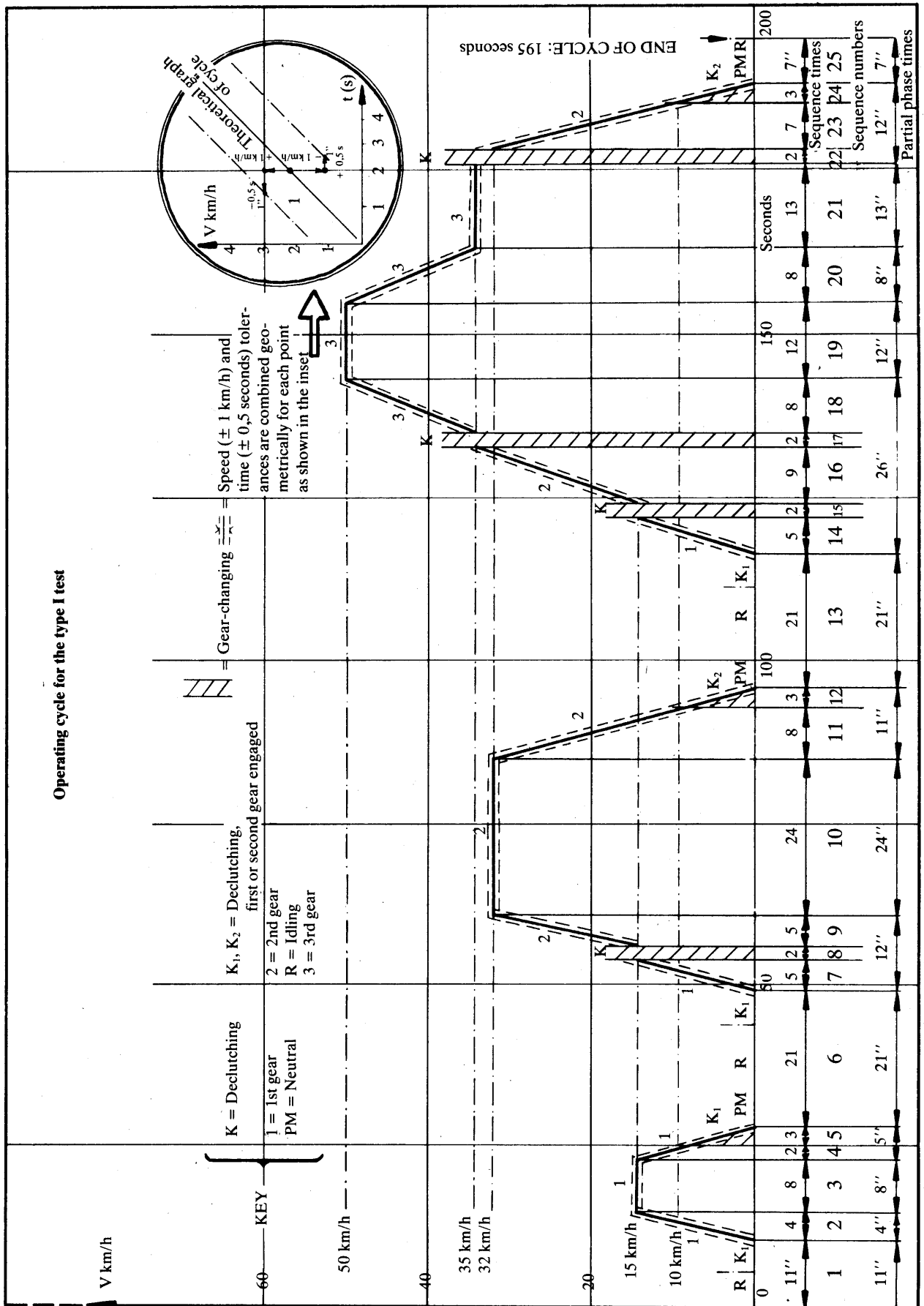

▼ **M4***APPENDIX 2***CHASSIS DYNAMOMETER****1. DEFINITION OF A CHASSIS DYNAMOMETER WITH FIXED LOAD CURVE****1.1. Introduction**

In the event that the total resistance to progress on the road cannot be reproduced on the chassis dynamometer between speeds of 10 and 50 km/h, it is recommended to use a chassis dynamometer having the characteristics defined below.

1.2. Definition**1.2.1. The chassis dynamometer may have one or two rollers.**

The front roller drives, directly or indirectly, the inertia masses and the power absorption device.

1.2.2. Having set the load at 50 km/h by one of the methods described in 3, K can be determined from $P = KV^3$.

The power absorbed (P_a) by the brake and the chassis internal frictional effects from the reference setting to a vehicle speed of 50 km/h, are as follows:

If $V > 12$ km/h:

$$P_a = KV^3 \pm 5 \% KV^3 \pm 5 \% PV_{50}$$

(without being negative).

If $V \leq 12$ km/h:

P_a will be between 0 and $P_a = KV_{12}^3 + 5 \% KV_{12}^3 + 5 \% PV_{50}$ where K is a characteristic of the chassis dynamometer and PV_{50} is the power absorbed at 50 km/h.

2. METHOD OF CALIBRATING THE DYNAMOMETER**2.1. Introduction**

This Appendix describes the method to be used to determine the power absorbed by a dynamometric brake.

The power absorbed comprises the power absorbed by frictional effects and the power absorbed by the power-absorption device. The dynamometer is brought into operation beyond the range of test speeds. The device used for starting up the dynamometer is then disconnected: the rotational speed of the driven roller decreases.

The kinetic energy of rollers is dissipated by the power-absorption unit and by the frictional effects. This method disregards variations in the roller's internal frictional effects caused by rollers with or without the vehicle. The frictional effects of the rear roller shall be disregarded when this is free.

2.2. Calibrating the power indicator to 50 km/h as a function of the power absorbed

The following procedure is used.

- 2.2.1. Measure the rotational speed of the roller if this has not already been done. A fifth wheel, a revolution counter or some other method may be used.
- 2.2.2. Place the vehicle on the dynamometer or devise some other method of starting up the dynamometer.
- 2.2.3. Use the fly-wheel or any other system of inertia simulation for the particular inertia class to be used.

▼ M4

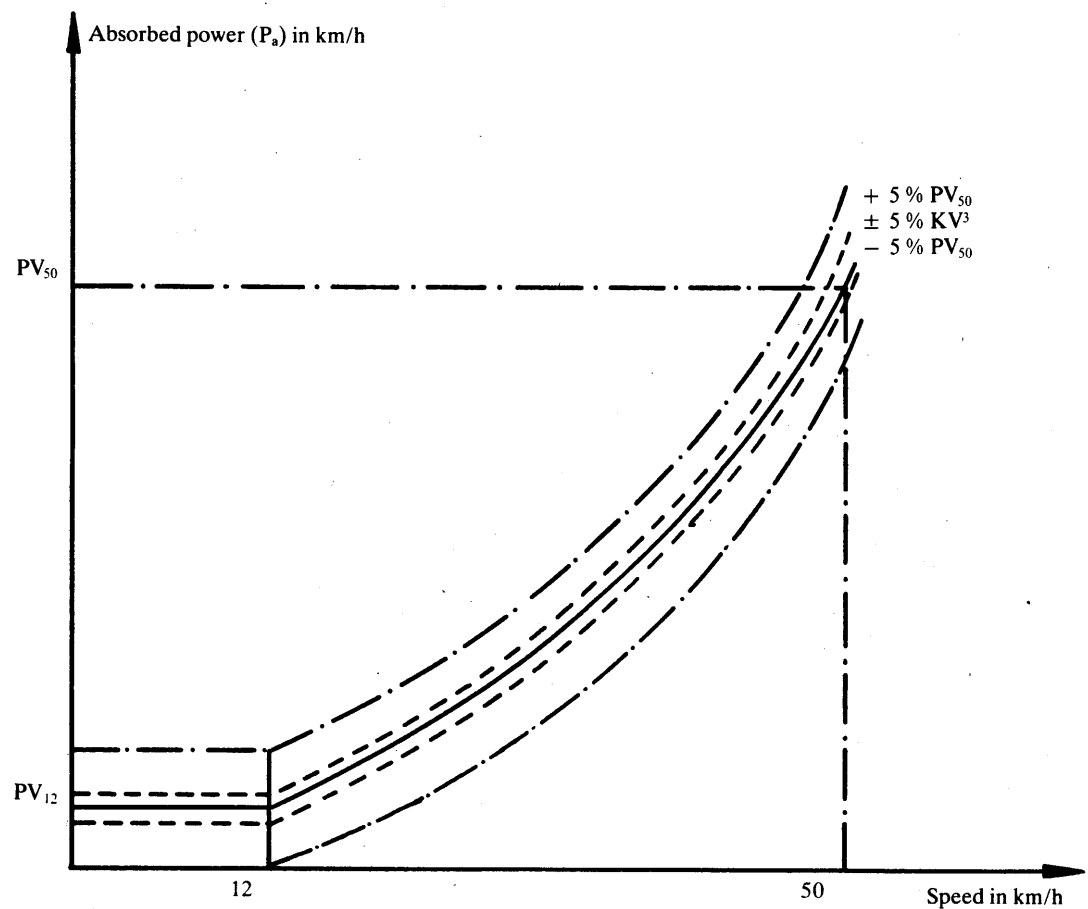

- 2.2.4. Bring the dynamometer to a speed of 50 km/h.
- 2.2.5. Note the power indicated (P_i).
- 2.2.6. Bring the dynamometer to a speed of 60 km/h.
- 2.2.7. Disconnect the device used to start up the dynamometer.
- 2.2.8. Note the time taken by the dynamometer to pass from a speed of 55 km/h to a speed of 45 km/h.
- 2.2.9. Set the power-absorption device at a different level.
- 2.2.10. The requirements of 2.2.4 to 2.2.9 must be repeated sufficiently often to cover the range of road powers used.
- 2.2.11. Calculate the power absorbed, using the formula:

$$P_a = \frac{M_j (V_1^2 - V_2^2)}{2000 t}$$

where

P_a = power absorbed in kW,

M_j = equivalent inertia in kg (excluding the inertial effects of the free rear roller),

V_1 = initial speed in m/s (55 km/h = 15,28 m/s),

V_2 = final speed in m/s (45 km/h = 12,50 m/s),

t = time taken by the roller to pass from 55 to 45 km/h.

- 2.2.12. Diagram showing power indicated at 50 km/h in terms of power absorbed at 50 km/h.

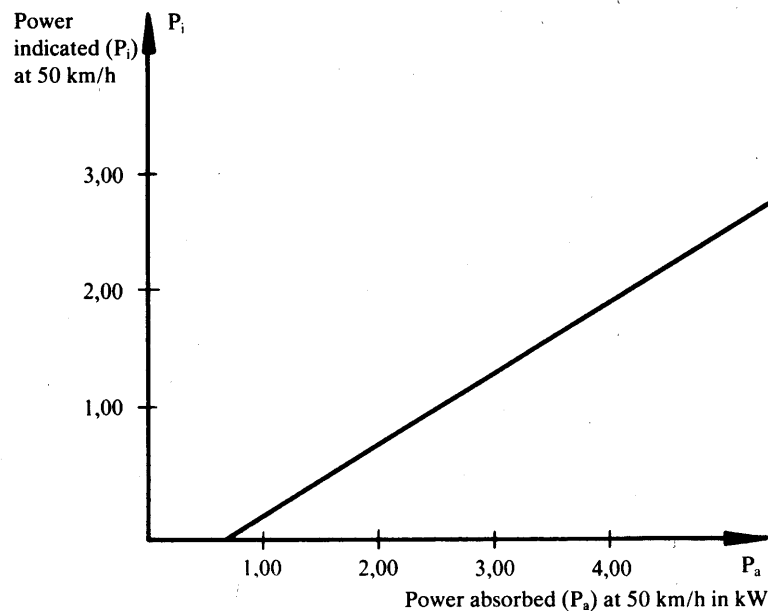
▼ **M4**

2.2.13. The operations described in 2.2.3 to 2.2.12 must be repeated for all inertia classes to be used.

2.3. **Calibration of the power indicator as a function of the absorbed power for other speeds**

The procedures described in 2.2 must be repeated as often as necessary for the chosen speeds.

2.4. **Verification of the power-absorption curve of the dynamometer from a reference setting at a speed of 50 km/h**

2.4.1. Place the vehicle on the dynamometer or devise some other method of starting up the dynamometer.

2.4.2. Adjust the dynamometer to the absorbed power (P_a) at 50 km/h.

2.4.3. Note the power absorbed at 40 — 30 — 20 km/h.

2.4.4. Draw the curve $P_a(V)$ and verify that it corresponds to the requirements of 1.2.2.

2.4.5. Repeat the procedure set out in 2.4.1 to 2.4.4 for other values of power P_a at 50 km/h and for other values of inertias.

2.5. The same procedure must be used for force or torque calibration.

3. **SETTING OF THE DYNAMOMETER**

3.1. **Vacuum method**

3.1.1. *Introduction*

This method is not a preferred method and must be used only with fixed load curve shape dynamometers for determination of load setting at 50 km/h and cannot be used for vehicles with compression-ignition engines.

3.1.2. *Test instrumentation*

The vacuum (or absolute pressure) in the intake manifold vehicle is measured to an accuracy of $\pm 0,25$ kPa. It must be possible to record this reading continuously or at intervals of no more than one second. The speed must be recorded continuously with a precision of $\pm 0,4$ km/h.

3.1.3. *Road test*

3.1.3.1. Ensure that the requirements of 4 of Appendix 3 are met.

▼ **M4**

- 3.1.3.2. Drive the vehicle at a steady speed of 50 km/h recording speed and vacuum (or absolute pressure) in accordance with the requirements of 3.1.2.
- 3.1.3.3. Repeat procedure set out in 3.1.3.2 three times in each direction. All six runs must be completed within four hours.
- 3.1.4. *Data reduction and acceptance criteria*
- 3.1.4.1. Review results obtained in accordance with 3.1.3.2 and 3.1.3.3 (speed must not be lower than 49,5 km/h or greater than 50,5 km/h for more than one second). For each run, read vacuum level at one-second intervals, calculate mean vacuum (\bar{v}) and standard deviation (s). This calculation must consist of no less than 10 readings of vacuum.
- 3.1.4.2. The standard deviation must not exceed 10 % of mean (\bar{v}) for each run.
- 3.1.4.3. Calculate the mean value (\bar{v}) for the six runs (three runs in each direction).
- 3.1.5. *Dynamometer setting*
- 3.1.5.1. Preparation
Perform the operations specified in 5.1.2.2.1 to 5.1.2.2.4 of Appendix 3.
- 3.1.5.2. Setting
After warm-up, drive the vehicle at a steady speed of 50 km/h and adjust dynamometer load to reproduce the vacuum reading (\bar{v}) obtained in accordance with 3.1.4.3. Deviation from this reading must be no greater than 0,25 kPa. The same instruments are used for this exercise as were used during the road test.

3.2. **Other setting methods**

The dynamometer setting may be carried out at a constant speed of 50 km/h in accordance with the requirements of Appendix 3.

3.3. **Alternative method**

With the manufacturer's agreement the following method may be used:

- 3.3.1. The brake is adjusted so as to absorb the power exerted at the driving wheels at a constant speed of 50 km/h in accordance with the following table:

Reference mass of vehicle: RW (kg)	Power absorbed by the dynamometer: P_a (kW)
$RW \leq 750$	1,3
$750 < RW \leq 850$	1,4
$850 < RW \leq 1\ 020$	1,5
$1\ 020 < RW \leq 1\ 250$	1,7
$1\ 250 < RW \leq 1\ 470$	1,8
$1\ 470 < RW \leq 1\ 700$	2,0
$1\ 700 < RW \leq 1\ 930$	2,1
$1\ 930 < RW \leq 2\ 150$	2,3
$2\ 150 < RW \leq 2\ 380$	2,4
$2\ 380 < RW \leq 2\ 610$	2,6
$2\ 610 < RW$	2,7

- 3.3.2. In the case of vehicles, other than passenger cars, with a reference mass of more than 1 700 kg, or vehicles whose wheels are all driven, the power values given in the table set out in 3.3.1 are multiplied by the factor 1,3.

▼ **M4***APPENDIX 3***RESISTANCE TO PROGRESS OF A VEHICLE — MEASUREMENT METHOD ON THE ROAD — SIMULATION ON A CHASSIS DYNAMOMETER**

1. OBJECT OF THE METHODS

The object of the methods defined below is to measure the resistance to progress of a vehicle at stabilized speeds on the road and to simulate this resistance on a dynamometer, in accordance with 4.1.4.1 of Annex III.

2. DEFINITION OF THE ROAD

The road must be level and sufficiently long to enable the measurements specified below to be made. The slope must be constant to within $\pm 0,1$ % and must not exceed 1,5 %.

3. ATMOSPHERIC CONDITIONS

3.1. **Wind**

Testing must be limited to wind speeds averaging less than 3 m/s with peak speeds less than 5 m/s. In addition, the vector component of the wind speed across the test road must be less than 2 m/s. Wind velocity must be measured 0,7 m above the road surface.

3.2. **Humidity**

The road must be dry.

3.3. **Pressure — Temperature**

Air density at the time of the test must not deviate by more than $\pm 7,5$ % from the reference conditions, $p = 100$ kPa and $T = 293,2$ K.

4. VEHICLE PREPARATION

4.1. **Running in**

The vehicle must be in normal running order and adjustment after having been run-in for at least 3 000 km. The tyres must be run in at the same time as the vehicle or have a tread depth within 90 and 50 % of the initial tread depth.

4.2. **Verifications**

The following checks must be made in accordance with the manufacturer's specifications for the use considered:

- wheels, wheel trims, tyres (make, type, pressure),
- front axle geometry,
- brake adjustment (elimination of parasitic drag),
- lubrication of front and rear axles,
- adjustment of the suspension and vehicle level, etc.

4.3. **Preparation for the test**

4.3.1. The vehicle is loaded to its reference mass. The level of the vehicle must be that obtained when the centre of gravity of the load is situated midway between the 'R' points of the front outer seats and on a straight line passing through those points.

4.3.2. In the case of road tests, the windows of the vehicle must be closed. Any covers of air climatization systems, headlamps, etc., must be in the non-operating position.

4.3.3. The vehicle must be clean.

4.3.4. Immediately prior to the test the vehicle is brought to normal running temperature in an appropriate manner.

▼ **M4**

5. METHODS

5.1. **Method of energy variation during coast-down**5.1.1. *On the road*

5.1.1.1. Test equipment and error

— Time must be measured to an error lower than 0,1 s.

— Speed must be measured to an error lower than 2 %.

5.1.1.2. Test procedure

5.1.1.2.1. Accelerate the vehicle to a speed 10 km/h greater than the chosen test speed V.

5.1.1.2.2. Place the gearbox in 'neutral' position

5.1.1.2.3. Measure the time taken for the vehicle to decelerate from

$$V_2 = V + \Delta V \text{ km/h to } V_1 = V - \Delta V \text{ km/h: } t_1 \cdot \Delta V \leq 5 \text{ km/h}$$

5.1.1.2.4. Perform the same test in the opposite direction: t_2 .

5.1.1.2.5. Take the average T_1 of the two times t_1 and t_2 .

5.1.1.2.6. Repeat these tests several times such that the statistical accuracy (p) of the average

$$T = \frac{1}{n} \cdot \sum_{i=1}^n T_i \text{ is no more than 2 \% (p} \leq 2 \text{ \%)}$$

The statistical accuracy (p) is defined by:

$$p = \frac{ts}{\sqrt{n}} \cdot \frac{100}{T}$$

where:

t = coefficient given by the table below,

s = standard deviation,

n = number of tests. $s = \sqrt{\frac{\sum_{i=1}^n (T_i - T)^2}{n - 1}}$

n	4	5	6	7	8	9	10	11	12	13	14	15
t	3,2	2,8	2,6	2,5	2,4	2,3	2,3	2,2	2,2	2,2	2,2	2,2
$\frac{t}{\sqrt{n}}$	1,6	1,25	1,06	0,94	0,85	0,77	0,73	0,66	0,64	0,61	0,59	0,57

5.1.1.2.7. Calculate the power by the formula:

$$P = \frac{M \cdot V \cdot \Delta V}{500 T}$$

where:

P is expressed in kW,

V = speed of the test in m/s,

ΔV = speed deviation from speed V, in m/s,

M = reference mass in kg,

T = time in seconds.

5.1.2. *On the dynamometer*

5.1.2.1. Measurement equipment and accuracy

The equipment must be identical to that used on the road.

5.1.2.2. Test procedure

5.1.2.2.1. Install the vehicle on the test dynamometer.

5.1.2.2.2. Adjust the tyre pressure (cold) of the driving wheels as required by the dynamometer.

▼ M4

- 5.1.2.2.3. Adjust the equivalent inertia of the dynamometer.
- 5.1.2.2.4. Bring the vehicle and dynamometer to operating temperature in a suitable manner.
- 5.1.2.2.5. Carry out the operations specified in 5.1.1.2 with the exception of 5.1.1.2.4 and 5.1.1.2.5 and with replacing M by I in the formula set out in 5.1.1.2.7.
- 5.1.2.2.6. Adjust the brake to meet the requirements of 4.1.4.1. of Annex III.

5.2. Torque measurement method at constant speed**5.2.1. On the road****5.2.1.1. Measurement equipment and error**

Torque measurement must be carried out with an appropriate measuring device accurate to within 2 %.

Speed measurement must be accurate to within 2 %.

5.2.1.2. Test procedure

- 5.2.1.2.1. Bring the vehicle to the chosen stabilized speed V.
- 5.2.1.2.2. Record the torque C(t) and speed over a period of a least 10 s by means of class 1 000 instrumentation meeting ISO standard No 970.
- 5.2.1.2.3. Differences in torque C(t) and speed relative to time must not exceed 5 % for each second of the measurement period.
- 5.2.1.2.4. The torque C_t is the average torque derived from the following formula:

$$C_t = \frac{1}{\Delta t} \int_t^{t+\Delta t} C(t) dt$$

- 5.2.1.2.5. Carry out the test in the opposite direction, i.e. C_e .
- 5.2.1.2.6. Determine the average of these two torques C_t and C_e i.e. C_r .

5.2.2. On the dynamometer**5.2.2.1. Measurement equipment and error**

The equipment must be identical to that used on the road.

5.2.2.2. Test procedure

- 5.2.2.2.1. Perform the operations specified in 5.1.2.2.1 to 5.1.2.2.4.
- 5.2.2.2.2. Perform the operations specified in 5.2.1.2.1 to 5.2.1.2.4.
- 5.2.2.2.3. Adjust the brake setting to meet the requirements of 4.1.4.1 of Annex III.

5.3. Integrated torque over variable driving pattern

- 5.3.1. This method is a non-obligatory complement to the constant speed method described in 5.2.

- 5.3.2. In this dynamic procedure the mean torque value \bar{M} is determined. This is accomplished by integrating the actual torque values with respect to time during operation of the test vehicle with a defined driving cycle. The integrated torque is then divided by the time difference.

The result is:

$$\bar{M} = \frac{1}{t_2 - t_1} \int_{t_1}^{t_2} M(t) \cdot dt \quad (\text{with } M(t) > 0)$$

\bar{M} is calculated from six sets of results.

It is recommended that the sampling rate of \bar{M} be not less than two samples per second.

▼ **M4**5.3.3. *Dynamometer setting*

The dynamometer load is set by the method described in 5.2. If \bar{M} dynamometer does not then match \bar{M} road, the brake setting is adjusted until the values are equal within $\pm 5\%$.

Note:

This method can be used only for dynamometers with electrical inertia simulation or fine adjustment.

5.3.4. *Acceptance criteria*

Standard deviation of six measurements must be no more than 2 % of the mean value.

5.4. **Method of deceleration measurement by gyroscopic platform**5.4.1. *On the road*

5.4.1.1. Measurement equipment and error

- Speed must be measured with an error lower than 2 %.
- Deceleration must be measured with an error lower than 1 %.
- The slope of the road must be measured with an error lower than 1 %.
- Time must be measured with an error lower than 0,1 s.

The level of the vehicle is measured on a reference horizontal ground; as an alternative, it is possible to correct for the slope of the road (α_1).

5.4.1.2. Test procedure

5.4.1.2.1. Accelerate the vehicle to a speed 5 km/h greater than the chosen test speed: V.

5.4.1.2.2. Record the deceleration between V + 0,5 km/h and V - 0,5 km/h.

5.4.1.2.3. Calculate the average deceleration attributed to the speed V by the formula:

$$\bar{\gamma}_1 = \frac{1}{t} \int_0^t \gamma_1(t) dt - g \cdot \sin \alpha_1$$

where:

$\bar{\gamma}_1$ = average deceleration value at the speed V in one direction of the road,

t = time between V + 0,5 km/h and V - 0,5 km/h,

$\gamma_1(t)$ = deceleration recorded with the time,

g = 9,81 m s⁻².

5.4.1.2.4. Perform the same test in the other direction: $\bar{\gamma}_2$.

5.4.1.2.5. Calculate the average of $\Gamma_i = \frac{\bar{\gamma}_1 + \bar{\gamma}_2}{2}$ for test i.

5.4.1.2.6. Perform a sufficient number of tests as specified in 5.1.1.2.6 replacing T by Γ where:

$$\Gamma = \frac{1}{n} \sum_{i=1}^n \Gamma_i$$

5.4.1.2.7. Calculate the average force absorbed $F = M \cdot \Gamma$

where:

M = vehicle reference mass in kg,

Γ = average deceleration calculated beforehand.

5.4.2. *Dynamometer method*

5.4.2.1. Measurement equipment and error

The measurement instrumentation of the dynamometer itself must be used as defined in 2 of Appendix 2 to this Annex.

▼ **M4**

5.4.2.2. Test procedure

5.4.2.2.1. Adjustment of the force on the rim under steady speed

On chassis dynamometer, the total resistance is of the type:

$$(F_{\text{total}}) = (F_{\text{indicated}}) + (F_{\text{driving axle rolling}}), \text{ with}$$

$$(F_{\text{total}}) = (F_{\text{road}}),$$

$$(F_{\text{indicated}}) = (F_{\text{road}}) - (F_{\text{driving axle rolling}}),$$

where:

$(F_{\text{indicated}})$ is the force indicated on the force indicating device of the chassis dynamometer,

(F_{road}) is known,

$(F_{\text{driving axle rolling}})$ can be:

— measured on chassis dynamometer able to work as a motor.

The test vehicle, gearbox in neutral position, is driven by the chassis dynamometer at the test speed; the rolling resistance of the driving axle is then measured on the force indicating device of the chassis dynamometer;

— determined on chassis dynamometer unable to work as a motor.

For the two-roller chassis dynamometer, the R_R value is the one which is determined before on the road.

For the single-roller chassis dynamometer, the R_R value is the one which is determined on the road multiplied by a coefficient (R) which is equal to the ratio between the driving axle mass and the vehicle total mass.

Note

R_R is obtained from the curve: $F = f(V)$.

▼ **M4***APPENDIX 4***VERIFICATION OF INERTIAS OTHER THAN MECHANICAL**

1. OBJECT

The method described in this Appendix makes it possible to check that the simulated total inertia of the dynamometer is carried out satisfactorily in the running phases of the operating cycle.

2. PRINCIPLE

2.1. **Drawing up working equations**

Since the dynamometer is subjected to variations in the rotating speed of the roller(s), the force at the surface of the roller(s) can be expressed by the formula:

$$F = I \cdot \gamma = I_M \cdot \gamma + F_I$$

where:

F = force at the surface of the roller(s),

I = total inertia of the dynamometer (equivalent inertia of the vehicle: cf. table in 5.1),

I_M = inertia of the mechanical masses of the dynamometer,

γ = tangential acceleration at roller surface,

F_I = inertia force.

Note:

An explanation of this formula with reference to dynamometers with mechanically simulated inertias is appended.

Thus, the total inertia is expressed as follows:

$$I = I_M + \frac{F_I}{\gamma}$$

where:

I_M can be calculated or measured by traditional methods,

F_I can be measured on the dynamometer,

γ can be calculated from the peripheral speed of the rollers.

The total inertia (I) is determined during an acceleration or deceleration test with values higher than or equal to those obtained on an operating cycle.

2.2. **Specification for the calculation of total inertia**

The test and calculation methods must make it possible to determine the total inertia I with a relative error ($\Delta I/I$) of less than 2 %.

3. SPECIFICATION

3.1. The mass of the simulated total inertia I must remain the same as the theoretical value of the equivalent inertia (see 5.1 of Annex III) within the following limits:

3.1.1. ± 5 % of the theoretical value for each instantaneous value;

3.1.2. ± 2 % of the theoretical value for the average value calculated for each sequence of the cycle.

3.2. The limit given in 3.1.1 is brought to ± 50 % for one second when starting and, for vehicles with manual transmission, for two seconds during gear changes.

4. VERIFICATION PROCEDURE

4.1. Verification is carried out during each test throughout the cycle defined in 2.1 of Annex III.

▼ **M4**

- 4.2. However, if the requirements of 3 are met, with instantaneous accelerations which are at least three times greater or smaller than the values obtained in the sequences of the theoretical cycle, the verification described above is not necessary.

5. TECHNICAL NOTE

Explanation of drawing-up working equations.

- 5.1. Equilibrium of the forces on the road:

$$CR = k_1 J_{r1} \frac{d\Theta 1}{dt} + k_2 J_{r2} \frac{d\Theta 2}{dt} + k_3 M \gamma r_1 + k_3 F_s r_1$$

- 5.2. Equilibrium of the forces on dynamometer with mechanically simulated inertias:

$$\begin{aligned} C_m &= k_1 J_{r1} \frac{d\Theta 1}{dt} + k_3 \frac{J_{Rm} \frac{dW_m}{dt}}{R_m} r_1 + k_3 F_s r_1 \\ &= k_1 J_{r1} \frac{d\Theta 1}{dt} + k_3 I \gamma r_1 + k_3 F_s r_1 \end{aligned}$$

- 5.3. Equilibrium of the forces of dynamometer with non-mechanically simulated inertias:

$$\begin{aligned} C_e &= k_1 J_{r1} \frac{d\Theta 1}{dt} + k_3 \left(\frac{J_{Re} \frac{dW_e}{dt}}{R_e} r_1 + \frac{C_1}{R_e} r_1 \right) + k_3 F_s r_1 \\ &= k_1 J_{r1} \frac{d\Theta 1}{dt} + k_3 (I_M \gamma + F_1) r_1 + k_3 F_s r_1 \end{aligned}$$

In these formulae:

- CR = engine torque on the road,
 C_m = engine torque on the dynamometer with mechanically simulated inertias,
 C_e = engine torque on the dynamometer with electrically simulated inertias,
 J_{r1} = moment of inertia of the vehicle transmission brought back to the driving wheels,
 J_{r2} = moment of inertia of the non-driving wheels,
 J_{Rm} = moment of inertia of the dynamometer with mechanically simulated inertias,
 J_{Re} = moment of mechanical inertia of the dynamometer with electrically simulated inertias,
 M = mass of the vehicle on the road,
 I = equivalent inertia of the dynamometer with mechanically simulated inertias,
 I_M = mechanical inertia of the dynamometer with electrically simulated inertias,
 F_s = resultant force at stabilized speed,
 C₁ = resultant torque from electrically simulated inertias,
 F₁ = resultant force from electrically simulated inertias,
 $\frac{d\Theta 1}{dt}$ = angular acceleration of the driving wheels,
 $\frac{d\Theta 2}{dt}$ = angular acceleration of the non-driving wheels,
 $\frac{dW_m}{dt}$ = angular acceleration of the mechanical dynamometer,

▼ M4

- $\frac{dW_e}{dt}$ = angular acceleration of the electrical dynamometer,
 γ = linear acceleration,
 r_1 = radius under load of the driving wheels,
 r_2 = radius under load of the non-driving wheels,
 R_m = radius of the rollers of the mechanical dynamometer,
 R_e = radius of the rollers of the electrical dynamometer,
 k_1 = coefficient dependent on the gear reduction ratio and the various inertias of transmission and 'efficiency',
 k_2 = ratio transmission X $\frac{r_1}{r_2}$ X 'efficiency',
 k_3 = ratio transmission X 'efficiency'.

Supposing the two types of dynamometer (5.2 and 5.3) are made equal and simplified, one obtains:

$$k_3 (I_M \cdot \gamma + F_1) r_1 = k_3 I \cdot \gamma \cdot r_1$$

hence,

$$I = I_M + \frac{F_1}{\gamma}$$

DEFINITION OF GAS-SAMPLING SYSTEMS

1. INTRODUCTION

- 1.1. There are several types of sampling devices capable of meeting the requirements set out in 4.2 of Annex III.

The devices described in 3.1, 3.2 and 3.3 will be deemed acceptable if they satisfy the main criteria relating to the variable dilution principle.

- 1.2. In its communications, the laboratory must mention the system of sampling used when performing the test.

2. CRITERIA RELATING TO THE VARIABLE-DILUTION SYSTEM FOR MEASURING EXHAUST-GAS EMISSIONS

2.1. **Scope**

This section specifies the operating characteristics of an exhaust-gas sampling system intended to be used for measuring the true mass emissions of a vehicle exhaust in accordance with the provisions of this Directive. The principle of variable-dilution sampling for measuring mass emissions requires three conditions to be satisfied:

- 2.1.1. the vehicle exhaust gases must be continuously diluted with ambient air under specified conditions;
- 2.1.2. the total volume of the mixture of exhaust gases and dilution air must be measured accurately;
- 2.1.3. a continuously proportional sample of the diluted exhaust gases and the dilution air must be collected for analysis.

Mass emissions are determined from the proportional sample concentrations and the total volume measured during the test. The sample concentrations are corrected to take account of the pollutant content of the ambient air.

2.2. **Technical summary**

Figure 1 gives a schematic diagram of the sampling system.

- 2.2.1. The vehicle exhaust gases must be diluted with a sufficient amount of ambient air to prevent any water condensation in the sampling and measuring system.
- 2.2.2. The exhaust-gas sampling system must make it possible to measure the average volume concentrations of the CO₂, CO, HC and NO_x contained in the exhaust gases emitted during the vehicle testing cycle.
- 2.2.3. The mixture of air and exhaust gases must be homogeneous at the point where the sampling probe is located (see 2.3.1.2).
- 2.2.4. The probe must extract a representative sample of the diluted exhaust gases.
- 2.2.5. The system must make it possible to measure the total volume of the diluted exhaust gases from the vehicle being tested.
- 2.2.6. The sampling system must be gas-tight. The design of the variable-dilution sampling system and the materials that go to make it up must be such that they do not affect the pollutant concentration in the diluted exhaust gases. Should any component in the system (heat exchanger, cyclone separator, blower, etc.) change the concentration of any of the pollutants in the diluted exhaust gases and the fault cannot be corrected, then sampling for that pollutant must be carried out before that component.
- 2.2.7. If the vehicle tested is equipped with an exhaust system comprising more than one tailpipe, the connecting tubes must be connected together by a manifold installed as near as possible to the vehicle.
- 2.2.8. The gas samples must be collected in sampling bags of adequate capacity so as not to hinder the gas flow during the sampling period. These bags must be made of such materials as will not affect the concentrations of pollutant gases (see 2.3.4.4).

▼ M4

- 2.2.9. The variable-dilution system must be so designed as to enable the exhaust gases to be sampled without appreciably changing the back-pressure at the exhaust pipe outlet (see 2.3.1.1).

2.3. Specific requirements**2.3.1. Exhaust-gas collection and dilution device**

- 2.3.1.1. The connection tube between the vehicle exhaust tailpipe(s) and the mixing chamber must be as short as possible; it must in no case:

- cause the static pressure at the exhaust tailpipe(s) on the vehicle being tested to differ by more than $\pm 0,75$ kPa at 50 km/h or more than $\pm 1,25$ kPa for the whole duration of the test from the static pressures recorded when nothing is connected to the vehicle tailpipes. The pressure must be measured in the exhaust tailpipe or in an extension having the same diameter, as near as possible to the end of the pipe,
- change the nature of the exhaust gas.

- 2.3.1.2. There must be a mixing chamber in which the vehicle exhaust gases and the dilution air are mixed so as to produce a homogeneous mixture at the chamber outlet.

The homogeneity of the mixture in any cross-section at the location of the sampling probe must not vary by more than ± 2 % from the average of the values obtained at at least five points located at equal intervals on the diameter of the gas stream. In order to minimize the effects on the conditions at the exhaust tailpipe and to limit the drop in pressure inside the dilution-air conditioning device, if any, the pressure inside the mixing chamber must not differ by more than $\pm 0,25$ kPa from atmospheric pressure.

2.3.2. Suction device/volume measuring device

This device may have a range of fixed speeds as to ensure sufficient flow to prevent any water condensation. This result is generally obtained by keeping the concentration of CO₂ in the dilute exhaust-gas sampling bag lower than 3 % by volume.

2.3.3. Volume measurement

- 2.3.3.1. The volume measuring device must retain its calibration accuracy to within ± 2 % under all operating conditions. If the device cannot compensate for variations in the temperature of the mixture of exhaust gases and dilution air at the measuring point, a heat exchanger must be used to maintain the temperature to within ± 6 °C of the specified operating temperature.

If necessary, a cyclone separator can be used to protect the volume measuring device.

▼M4

Figure 1

Diagram of a variable-dilution system for measuring exhaust-gas emissions

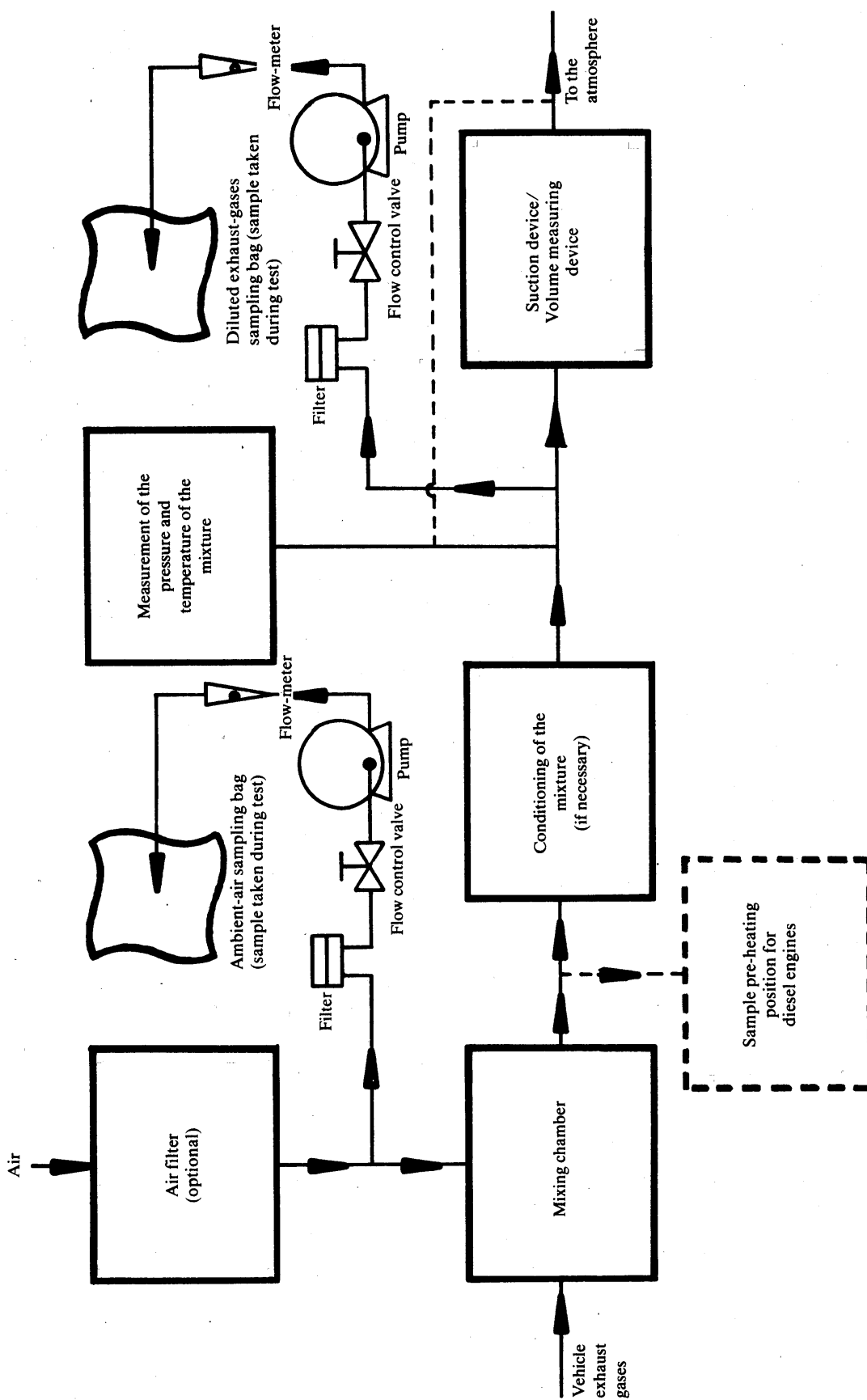

▼ **M4**

- 2.3.3.2. A temperature sensor must be installed immediately before the volume measuring device. This temperature sensor must have an accuracy and a precision of ± 1 °C and a response time of 0,1 s at 62 % of a given temperature variation (value measured in silicone oil).
- 2.3.3.3. The pressure measurements must have a precision and an accuracy of $\pm 0,4$ kPa during the test.
- 2.3.3.4. The measurement of the pressure difference from atmospheric pressure is taken before and, if necessary, after the volume measuring device.
- 2.3.4. *Gas sampling*
- 2.3.4.1. Dilute exhaust gases
 - 2.3.4.1.1. The sample of dilute exhaust gases is taken before the suction device but after the conditioning devices (if any).
 - 2.3.4.1.2. The flow-rate must not deviate by more than ± 2 % from the average.
 - 2.3.4.1.3. The sampling rate must not fall below 5 litres per minute and must not exceed 0,2 % of the flow-rate of the dilute exhaust gases.
 - 2.3.4.1.4. An equivalent limit applies to constant-mass sampling systems.
- 2.3.4.2. Dilution air
 - 2.3.4.2.1. A sample of the dilution air is taken at a constant flow-rate near the ambient air inlet (after the filter if one is fitted).
 - 2.3.4.2.2. The air must not be contaminated by exhaust gases from the mixing area.
 - 2.3.4.2.3. The sampling rate for the dilution air must be comparable to that used in the case of the dilute exhaust gases.
- 2.3.4.3. Sampling operations
 - 2.3.4.3.1. The materials used for the sampling operations must be such that they do not change the pollutant concentration.
 - 2.3.4.3.2. Filters may be used in order to extract the solid particles from the sample.
 - 2.3.4.3.3. Pumps are required in order to convey the sample to the sampling bag(s).
 - 2.3.4.3.4. Flow control valves and flow-meters are needed in order to obtain the flow-rates required for sampling.
 - 2.3.4.3.5. Quick-fastening gas-tight connections may be used between the three-way valves and the sampling bags, the connections sealing themselves automatically on the bag side. Other systems may be used for conveying the samples to the analyzer (three-way stop valves, for example).
 - 2.3.4.3.6. The various valves used for directing the sampling gases must be of the quick-adjusting and quick-acting type.
- 2.3.4.4. Storage of the sample

The gas samples are collected in sampling bags of adequate capacity so as not to reduce the sampling rate. The bags must be made of such a material as will not change the concentration of synthetic pollutant gases by more than ± 2 % after 20 minutes.
- 2.4. **Additional sampling apparatus for testing diesel-engined vehicles**
- 2.4.1. A sampling point after and close to the mixing chamber
- 2.4.2. Heated piping and sampling probe
- 2.4.3. Heated filter and/or pump (the latter may be located in the vicinity of the sample source)
- 2.4.4. A quick-acting connection for analyzing the sample of ambient air collected in the bag
- 2.4.5. All heated components must be kept at a temperature of 190 ± 10 °C by the heated system.

▼ **M4**

- 2.4.6. If it is not possible to compensate for variations in the flow-rate, there must be a heat exchanger and a temperature control device having the characteristics specified in 2.3.3.1 so as to ensure that the flow-rate in the system is constant and the sampling rate is accordingly proportional.
3. DESCRIPTION OF THE DEVICES
- 3.1. **Variable dilution device with positive displacement pump (PDP-CVS) (Figure 1)**
- 3.1.1. The positive displacement pump — constant volume sampler (PDP-CVS) satisfies the requirements of this Annex by metering at a constant temperature and pressure through the pump. The total volume is measured by counting the revolutions made by the calibrated positive displacement pump. The proportional sample is achieved by sampling with pump, flow-meter and flow control valve at a constant flow-rate.
- 3.1.2. Figure 1 is a schematic drawing of such a sampling system. Since various configurations can produce accurate results exact conformity with the drawing is not essential. Additional components such as instruments, valves, solenoids and switches may be used to provide additional information and coordinate the functions of the component system.
- 3.1.3. The collecting equipment consists of:
- 3.1.3.1. A filter (D) for the dilution air, which can be preheated if necessary. This filter must consist of activated charcoal sandwiched between two layers of paper, and shall be used to reduce and stabilize the hydrocarbon concentrations of ambient emissions in the dilution air.
- 3.1.3.2. A mixing chamber (M) in which exhaust gas and air are mixed homogeneously.
- 3.1.3.3. A heat exchanger (H) of a capacity sufficient to ensure that throughout the test the temperature of the air/exhaust-gas mixture measured at a point immediately upstream of the positive displacement pump is within ± 6 °C of the designed operating temperature. This device must not affect the pollutant concentrations of diluted gases taken off after for analysis.
- 3.1.3.4. A temperature control system (TC), used to preheat the heat exchanger before the test and to control its temperature during the test, so that deviations from the designed operating temperature are limited to ± 6 °C.
- 3.1.3.5. The positive displacement pump (PDP), used to transport a constant-volume flow of the air/exhaust-gas mixture; the flow capacity of the pump must be large enough to eliminate water condensation in the system under all operating conditions which may occur during a test; this can be generally ensured by using a positive displacement pump with a flow capacity:
- 3.1.3.5.1. — twice as high as the maximum flow of exhaust gas produced by accelerations of the driving cycle, or
- 3.1.3.5.2. — sufficient to ensure that the CO₂ concentration in the dilute-exhaust sample bag is less than 3 % by volume.
- 3.1.3.6. A temperature sensor (T₁) (accuracy and precision ± 1 °C), fitted at a point immediately upstream of the positive displacement pump; it must be designed to monitor continuously the temperature of diluted exhaust-gas mixture during the test.
- 3.1.3.7. A pressure gauge (G₁) (accuracy and precision $\pm 0,4$ kPa) fitted immediately upstream of the volume meter and used to register the pressure gradient between the gas mixture and the ambient air.
- 3.1.3.8. Another pressure gauge (G₂) (accuracy and precision $\pm 0,4$ kPa) fitted so that the differential pressure between pump inlet and pump outlet can be registered.
- 3.1.3.9. Two sampling outlets (S₁ and S₂) for taking constant samples of the dilution air and of the diluted exhaust-gas/air mixture.
- 3.1.3.10. A filter (F), to extract solid particles from the flows of gas collected for analysis.
- 3.1.3.11. Pumps (P), to collect a constant flow of the dilution air as well as of the diluted exhaust-gas/air mixture during the test.

▼ **M4**

- 3.1.3.12. Flow controllers (N), to ensure a constant uniform flow of the gas samples taken during the course of the test from sampling probes S_1 and S_2 ; and flow of the gas samples must be such that, at the end of each test, the quantity of the samples is sufficient for analysis (~ 10 litres per minute).
- 3.1.3.13. Flow meters (FL), for adjusting and monitoring the constant flow of gas samples during the test.
- 3.1.3.14. Quick-acting valves (V), to divert a constant flow of gas samples into the sampling bags or to the outside vent.
- 3.1.3.15. Gas-tight, quick-lock coupling elements (Q) between the quick-acting valves and the sampling bags; the coupling must close automatically on the sampling-bag side; as an alternative, other ways of transporting the samples to the analyzer may be used (three-way stopcocks, for instance).
- 3.1.3.16. Bags (B), for collecting samples of the diluted exhaust gas and of the dilution air during the test; they must be of sufficient capacity not to impede the sample flow; the bag material must be such as to affect neither the measurements themselves nor the chemical composition of the gas samples (for instance: laminated polyethylene/polyamide films, or fluorinated polyhydrocarbons).
- 3.1.3.17. A digital counter (C), to register the number of revolutions performed by the positive displacement pump during the test.

3.1.4. *Additional equipment required when testing diesel-engined vehicles*

To comply with the requirements of 4.3.1.1 and 4.3.2 of Annex III, the additional components within the dotted lines in Figure 1 must be used when testing diesel-engined vehicles:

- F_h is a heated filter,
- S₃ is a sample point close to the mixing chamber,
- V_h is a heated multiway valve,
- Q is a quick connector to allow the ambient air sample BA to be analyzed on the HFID,
- HFID is a heated flame ionization analyzer,

▼M4

Figure 1
 Constant volume sampler with positive displacement pump (PDP-CVS)

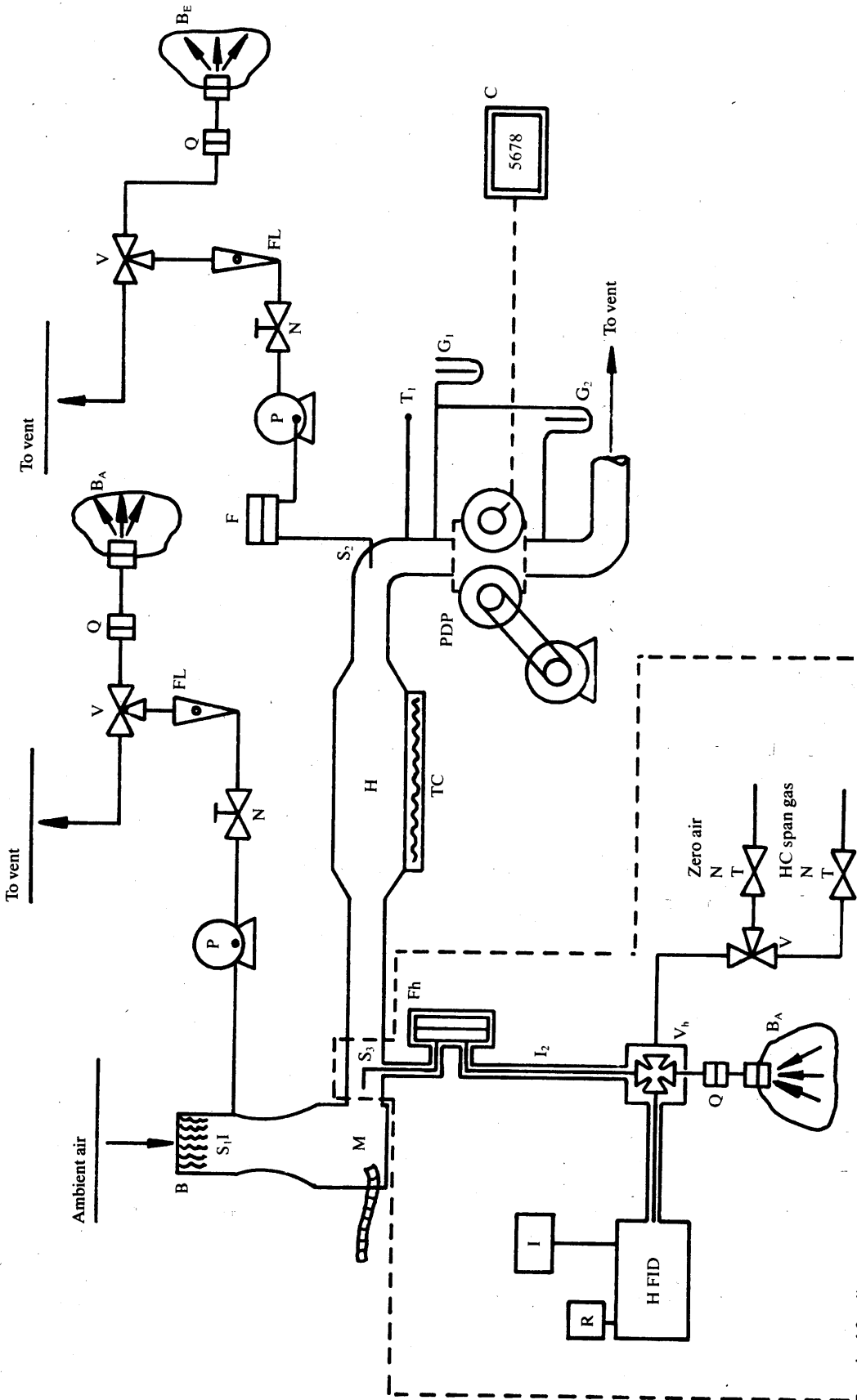

▼ **M4**

R and I are a means of integrating and recording the instantaneous hydrocarbon concentrations,

Lh is a heated sample line.

All heated components must be maintained at 190 ± 10 °C.

3.2. **Critical-flow venturi dilution device (CFV-CVS) (Figure 2)**

3.2.1. Using a critical-flow venturi in connection with the CVS sampling procedure is based on the principles of flow mechanics for critical flow. The variable mixture flow rate of dilution and exhaust gas is maintained at sonic velocity which is directly proportional to the square root of the gas temperature. Flow is continually monitored, computed and integrated over the test.

If an additional critical-flow sampling venturi is used, the proportionality of the gas samples taken is ensured. As both pressure and temperature are equal at the two venturi inlets the volume of the gas flow diverted for sampling is proportional to the total volume of diluted exhaust-gas mixture produced, and thus the requirements of this Annex are met.

3.2.2. Figure 2 is a schematic drawing of such a sampling system. Since various configurations can produce accurate results, exact conformity with the drawing is not essential. Additional components such as instruments, valve, solenoids, and switches may be used to provide additional information and coordinate the functions of the component system.

3.2.3. The collecting equipment consists of:

3.2.3.1. A filter (D) for the dilution air, which can be preheated if necessary: the filter must consist of activated charcoal sandwiched between layers of paper, and must be used to reduce and stabilize the hydrocarbon background emission of the dilution air.

3.2.3.2. A mixing chamber (M), in which exhaust gas and air are mixed homogeneously.

3.2.3.3. A cyclone separator (CS), to extract particles.

3.2.3.4. Two sampling probes (S_1 and S_2), for taking samples of the dilution air as well as of the diluted exhaust gas.

3.2.3.5. A sampling critical flow venturi (SV), to take proportional samples of the diluted exhaust gas at sampling probe S_2 .

3.2.3.6. A filter (F), to extract solid particles from the gas flows diverted for analysis.

3.2.3.7. Pumps (P), to collect part of the flow of air and diluted exhaust gas in bags during the test.

3.2.3.8. A flow controller (N), to ensure a constant flow of the gas samples taken in the course of the test from sampling probe S_1 ; the flow of the gas samples must be such that, at the end of the test, the quantity of the samples is sufficient for analysis (~ 10 litres per minute).

3.2.3.9. A snubber (PS), in the sampling line.

3.2.3.10. Flow meters (FL), for adjusting and monitoring the flow of gas samples during tests.

3.2.3.11. Quick-acting solenoid valves (V), to divert a constant flow of gas samples into the sampling bags or the vent.

3.2.3.12. Gas-tight, quick-lock coupling elements (Q), between the quick-acting valves and the sampling bags; the couplings must close automatically on the sampling-bag side; as an alternative, other ways of transporting the samples to the analyzer may be used (three-way stopcocks, for instance).

3.2.3.13. Bags (B), for collecting samples of the diluted exhaust gas and the dilution air during the tests; they must be of sufficient capacity not to impede the sample flow; the bag material must be such as to affect neither the measurements themselves nor the chemical composition of the gas samples (for instance: laminated polyethylene/polyamide films, or fluorinated polyhydrocarbons).

3.2.3.14. A pressure gauge (G), which is precise and accurate to within $\pm 0,4$ kPa.

▼ **M4**

- 3.2.3.15. A temperature sensor (T), which is precise and accurate to within ± 1 °C and have a response time of 0,1 seconds to 62 % of a temperature change (as measured in silicon oil).
- 3.2.3.16. A measuring critical flow venturi tube (MV), to measure the flow volume of the diluted exhaust gas.
- 3.2.3.17. A blower (BL), of sufficient capacity to handle the total volume of diluted exhaust gas.
- 3.2.3.18. The capacity of the CFV-CVS system must be such that under all operating conditions which may possibly occur during a test there will be no condensation of water. This is generally ensured by using a blower whose capacity is:
 - 3.2.3.18.1. twice as high as the maximum flow of exhaust gas produced by accelerations of the driving cycle;
 - 3.2.3.18.2. sufficient to ensure that the CO₂ concentration in the dilute exhaust sample bag is less than 3 % by volume.
- 3.2.4. *Additional equipment required when testing diesel-engined vehicles*

To comply with the requirements of 4.3.1.1 and 4.3.2 of Annex III, the additional components shown within the dotted lines of Figure 2 must be used when testing diesel-engined vehicles:

- Fh is a heated filter,
- S₃ is a sample point close to the mixing chamber,
- Vh is a heated multiway valve,
- Q is a quick connector to allow the ambient air sample BA to be analyzed on the HFID,
- HFID is a heated flame ionization analyzer,
- R and I are a means of integrating and recording the instantaneous hydrocarbon concentrations,
- Lh is a heated sample line.

All heated components must be maintained at 190 ± 10 °C.

If compensation for varying flow is not possible, then a heat exchanger (H) and temperature control system (TC) as described in 2.2.3 will be required to ensure constant flow through the venturi (MV) and thus proportional flow through S₃.

▼M4

Figure 2

Constant volume sampler with critical-flow venturi (CFV-CVS)

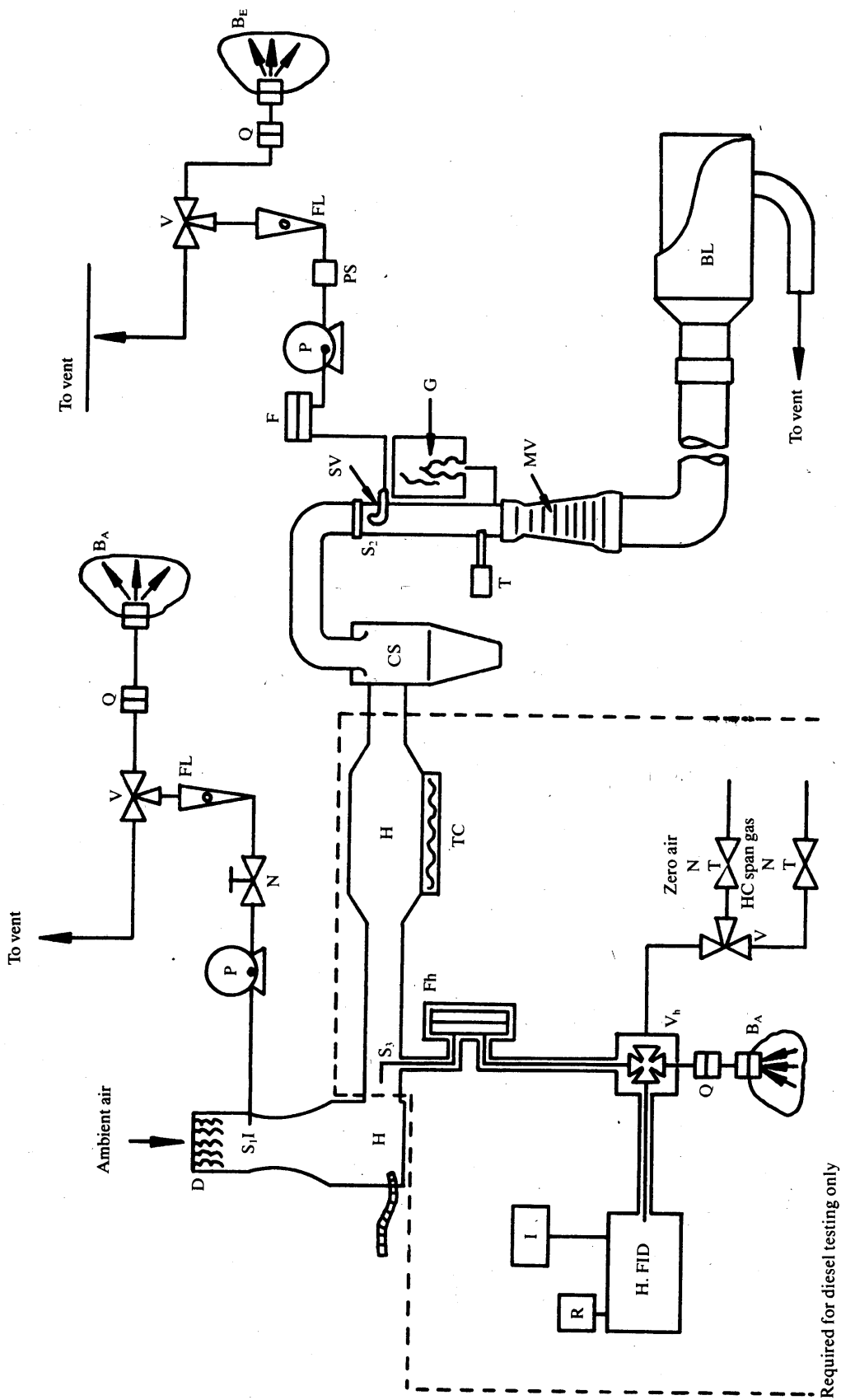

▼ **M4**

- 3.3. **Variable dilution device with constant flow control by orifice (CFO-CVS)** (Figure 3)
- 3.3.1. The collection equipment consists of:
- 3.3.1.1. A sampling tube connecting the vehicle's exhaust pipe to the device itself.
- 3.3.1.2. A sampling device consisting of a pump device for drawing in a diluted mixture of exhaust gas and air.
- 3.3.1.3. A mixing chamber (M) in which exhaust gas and air are mixed homogeneously.
- 3.3.1.4. A heat exchanger (H) of a capacity sufficient to ensure that throughout the test the temperature of the air/exhaust-gas mixture measured at a point immediately before the positive displacement of the flow-rate measuring device is within ± 6 °C of the designed operating temperature. This device must not alter the pollutant concentration of diluted gases taken off for analysis.
- Should this condition not be satisfied for certain pollutants, sampling will be effected before the cyclone for one or several considered pollutants.
- If necessary, a device for temperature control (TC) is used to preheat the heat exchanger before testing and to keep up its temperature during the test at ± 6 °C.
- 3.3.1.5. Two probes (S_1 and S_2) for sampling by means of pumps (P) flow-meters (FL) and, if necessary, filters (F) allowing for the collection of solid particles from gases used for the analysis.
- 3.3.1.6. One pump for dilution air and another one for diluted mixture.
- 3.3.1.7. A volume-meter with an orifice.
- 3.3.1.8. A temperature censor (T_1) (accuracy and precision ± 1 °C), fitted at a point immediately before the volume measurement device; it must be designed to monitor continuously the temperature of the diluted exhaust-gas mixture during the test.
- 3.3.1.9. A pressure gauge (G_1) (accuracy and precision $\pm 0,4$ kPa) fitted immediately before the volume meter and used to register the pressure gradient between the gas mixture and the ambient air.
- 3.3.1.10. Another pressure gauge (G_2) (accuracy and precision $\pm 0,4$ kPa) fitted so that the differential pressure between pump inlet and pump outlet can be registered.
- 3.3.1.11. Flow controllers (N) to ensure a constant uniform flow of gas samples taken during the course of the test from sampling outlets S_1 and S_2 . The flow of the gas samples must be such that, at the end of each test, the quantity of the samples is sufficient for analysis (~ 10 litres per minute).
- 3.3.1.12. Flow-meters (FL) for adjusting and monitoring the constant flow of gas samples during the test.
- 3.3.1.13. Three-way valves (V) to divert a constant flow of gas samples into the sampling bags or to the outside vent.
- 3.3.1.14. Gas-tight, quick-lock coupling elements (Q) between the three-way valves and the sampling bags; the coupling must close automatically on the sampling-bag side. Other ways of transporting the samples to the analyzer may be used (three-way stopcocks, for instance).
- 3.3.1.15. Bags (B) for collecting samples of diluted exhaust gas and of dilution air during the test. They must be of sufficient capacity not to impede the sample flow. The bag material must be such as to affect neither the measurements themselves nor the chemical composition of the gas samples (for instance: laminated polyethylene/polyamide films, or fluorinated polyhydrocarbons).

▼M4

Figure 3

Diagram of a variable dilution device with constant flow control by orifice (CFO-CVS)

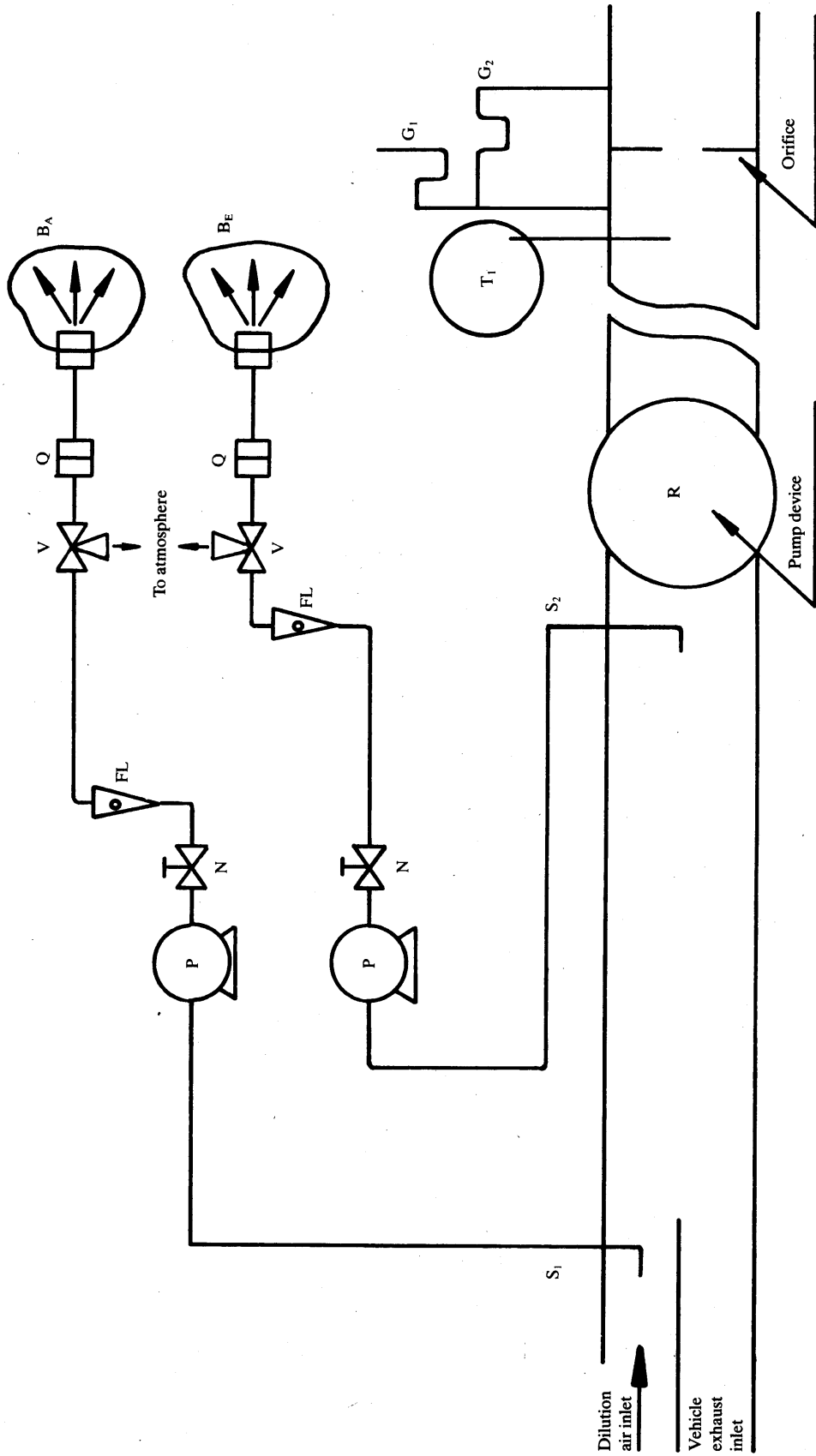

APPENDIX 6

METHOD OF CALIBRATING THE EQUIPMENT

1. ESTABLISHMENT OF THE CALIBRATION CURVE
 - 1.1. Each normally used operating range is calibrated in accordance with the requirements of 4.3.3 of Annex III by the following procedure:
 - 1.2. The analyzer calibration curve is established by at least five calibration points spaced as uniformly as possible. The nominal concentration of the calibration gas of the highest concentration must be not less than 80 % of the full scale.
 - 1.3. The calibration curve is calculated by the least squares method. If the resulting polynomial degree is greater than 3, the number of calibration points must be at least equal to this polynomial degree plus 2.
 - 1.4. The calibration curve must not differ by more than 2 % from the nominal value of each calibration gas.
 - 1.5. **Trace of the calibration curve**
 From the trace of the calibration curve and the calibration points it is possible to verify that the calibration has been carried out correctly. The different characteristic parameters of the analyzer must be indicated, particularly:
 - the scale,
 - the sensitivity,
 - the zero point,
 - the date of carrying out the calibration.
 - 1.6. If it can be shown to the satisfaction of the technical service that alternative technology (e.g. computer, electronically controlled range switch, etc.) can give equivalent accuracy, then these alternatives may be used.
2. VERIFICATION OF THE CALIBRATION
 - 2.1. Each normally used operating range must be checked prior to each analysis in accordance with the following:
 - 2.2. The calibration is checked by using a zero gas and a span gas whose nominal value is near to the supposed value to be analyzed.
 - 2.3. If, for the two points considered, the value found does not differ by more than ± 5 % of the full scale from the theoretical value, the adjustment parameters may be modified. Should this not be the case, a new calibration curve must be established in accordance with 1.
 - 2.4. After testing, zero gas and the same span gas are used for re-checking. The analysis is considered acceptable if the difference between the two measuring results is less than 2 %.
3. EFFICIENCY TEST OF THE NO_x CONVERTER
 The efficiency of the converter used for the conversion of NO₂ into NO is tested as follows:
 Using the test set up as shown in Figure 1 and the procedure described below, the efficiency of converters can be tested by means of an ozonator.
 - 3.1. Calibrate the CLA in the most common operating range following the manufacturer's specifications using zero and span gas (the NO content of which must amount to about 80 % of the operating range and the NO₂ concentration of the gas mixture to less than 5 % of the NO concentration). The NO_x analyzer must be in the NO mode so that the span gas does not pass through the converter. Record the indicated concentration.
 - 3.2. Via a T-fitting, oxygen or synthetic air is added continuously to the gas flow until the concentration indicated is about 10 % less than the indicated calibration concentration given in 3.1. Record the indicated concentration (C). The ozonator is kept deactivated throughout this process.

▼ M4

- 3.3. The ozonator is now activated to generate enough ozone to bring the NO concentration down to 20 % (minimum 10 %) of the calibration concentration given in 3.1. Record the indicated concentration (d).
- 3.4. The NO_x analyzer is then switched to the NO_x mode which means that the gas mixture (consisting of NO, NO₂, O₂ and N₂) now passes through the converter. Record the indicated concentration (a).
- 3.5. The ozonator is now deactivated. The mixture of gases described in 3.2 passes through the converter into the detector. Record the indicated concentration (b).

Figure 1

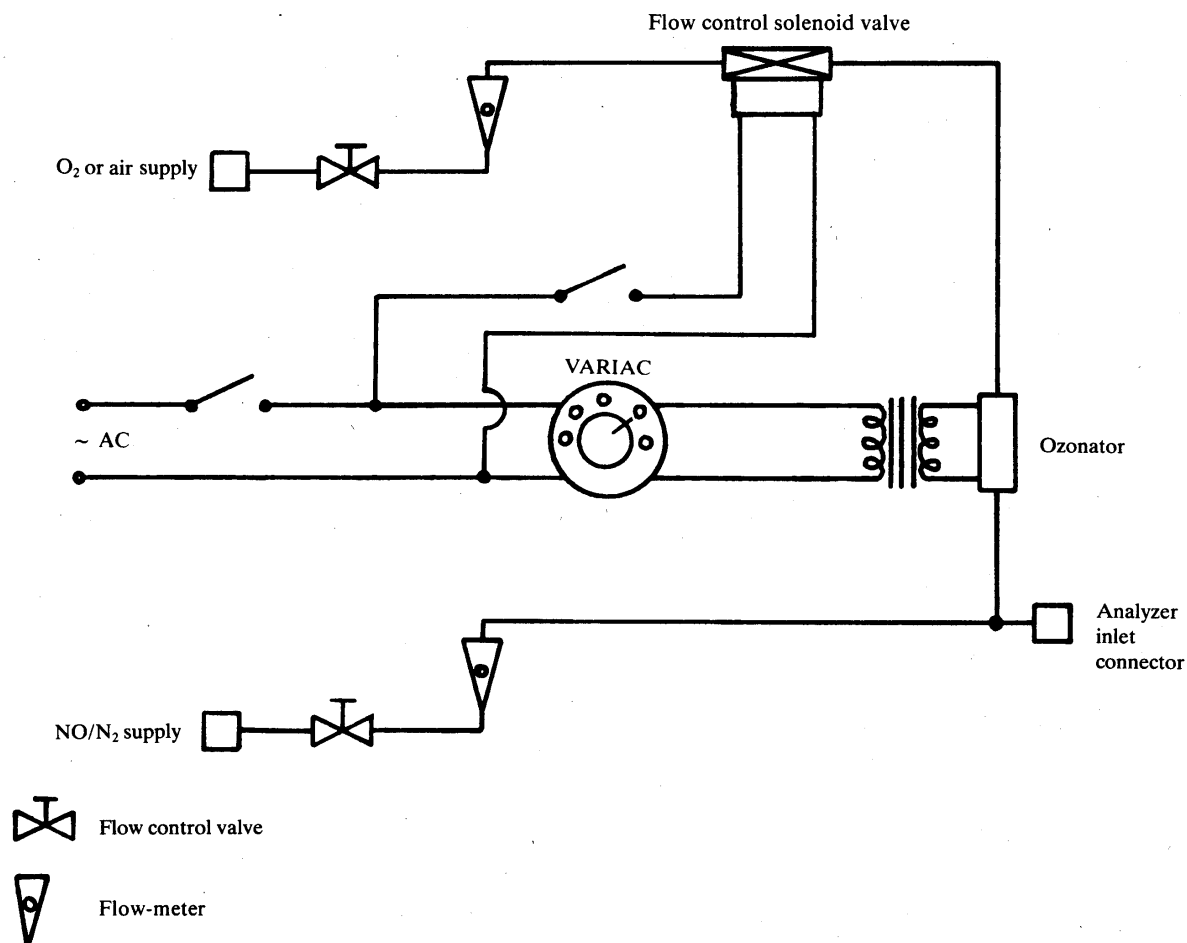

- 3.6. With the ozonator deactivated, the flow of oxygen or synthetic air is also shut off. The NO_x reading of the analyzer must then be no more than 5 % above the figure given in 3.1.
- 3.7. The efficiency of the NO_x converter is calculated as follows:

$$\text{Efficiency (\%)} = \left(1 + \frac{a - b}{c - d} \right) \times 100$$

- 3.8. The efficiency of the converter must not be less than 95 %.
- 3.9. The efficiency of the converter must be tested at least once a week.

4. CALIBRATION OF THE CVS SYSTEM

- 4.1. The CVS system must be calibrated by using an accurate flow-meter and a restricting device. The flow through the system must be measured at various pressure readings and the control parameters of the system measured and related to the flows.
- 4.1.1. Various types of flow-meter may be used, e.g. calibrated venturi, laminar flow-meter, calibrated turbine-meter, provided that they are

▼ **M4**

dynamic measurement systems and can meet the requirements of 4.2.2 and 4.2.3 of Annex III.

- 4.1.2. The following sections give details of methods of calibrating PDP and CFV units, using a laminar flow-meter, which gives the required accuracy, together with a statistical check on the calibration validity.

4.2. **Calibration of the positive displacement pump (PDP)**

- 4.2.1. The following calibration procedure outlines the equipment, the test configuration and the various parameters which are measured to establish the flow-rate of the CVS pump. All the parameters related to the pump are simultaneously measured with the parameters related to the flow-meter which is connected in series with the pump. The calculated flow-rate (given in m³/min at pump inlet, absolute pressure and temperature) can then be plotted versus a correlation function which is the value of a specific combination of pump parameters. The linear equation which relates the pump flow and the correlation function is then determined. In the event that a CVS has a multiple speed drive, a calibration for each range used must be performed.

- 4.2.2. This calibration procedure is based on the measurement of the absolute values of the pump and flow-meter parameters that relate the flow-rate at each point. Three conditions must be maintained to ensure the accuracy and integrity of the calibration curve.

- 4.2.2.1. The pump pressures must be measured at tapings on the pump rather than at the external piping on the pump inlet and outlet. Pressure taps that are mounted at the top centre and bottom centre of the pump drive headplate are exposed to the actual pump cavity pressures, and therefore reflect the absolute pressure differentials.

- 4.2.2.2. Temperature stability must be maintained during the calibration. The laminar flow-meter is sensitive to inlet temperature oscillations which cause the data points to be scattered. Gradual changes of ± 1 °C in temperature are acceptable as long as they occur over a period of several minutes.

- 4.2.2.3. All connections between the flow-meter and the CVS pump must be free of any leakage.

- 4.2.3. During an exhaust emission test, the measurement of these same pump parameters enables the user to calculate the flow-rate from the calibration equation.

- 4.2.3.1. Figure 2 of this Appendix shows one possible test set-up. Variations are permissible, provided that they are approved by the authority granting the approval as being of comparable accuracy. If the set-up shown in Figure 2 of Appendix 5 is used, the following data must be found within the limits of precision given:

barometric pressure (corrected) (P_B)	$\pm 0,03$ kPa
ambient temperature (T)	$\pm 0,2$ °C
air temperature at LFE (ETI)	$\pm 0,15$ °C
pressure depression upstream of LFE (EPI)	$\pm 0,01$ kPa
pressure drop across the LFE matrix (EDP)	$\pm 0,0015$ kPa
air temperature at CVS pump inlet (PTI)	$\pm 0,2$ °C
air temperature at CVS pump outlet (PTO)	$\pm 0,2$ °C
pressure depression at CVS pump inlet (PPI)	$\pm 0,22$ kPa
pressure head at CVS pump outlet (PPO)	$\pm 0,22$ kPa
pump revolutions during test period (n)	± 1 rev
elapsed time for period (minimum 250 s) (t)	$\pm 0,1$ s

- 4.2.3.2. After the system has been connected as shown in Figure 2, set the variable restrictor in the wide-open position and run the CVS pump for 20 minutes before starting the calibration.

▼ M4

- 4.2.3.3. Reset the restrictor valve to a more restricted condition in an increment of pump inlet depression (about 1 kPa) that will yield a minimum of six data points for the total calibration. Allow the system to stabilize for three minutes and repeat the data acquisition.

Figure 2

PDP-CVS calibration configuration

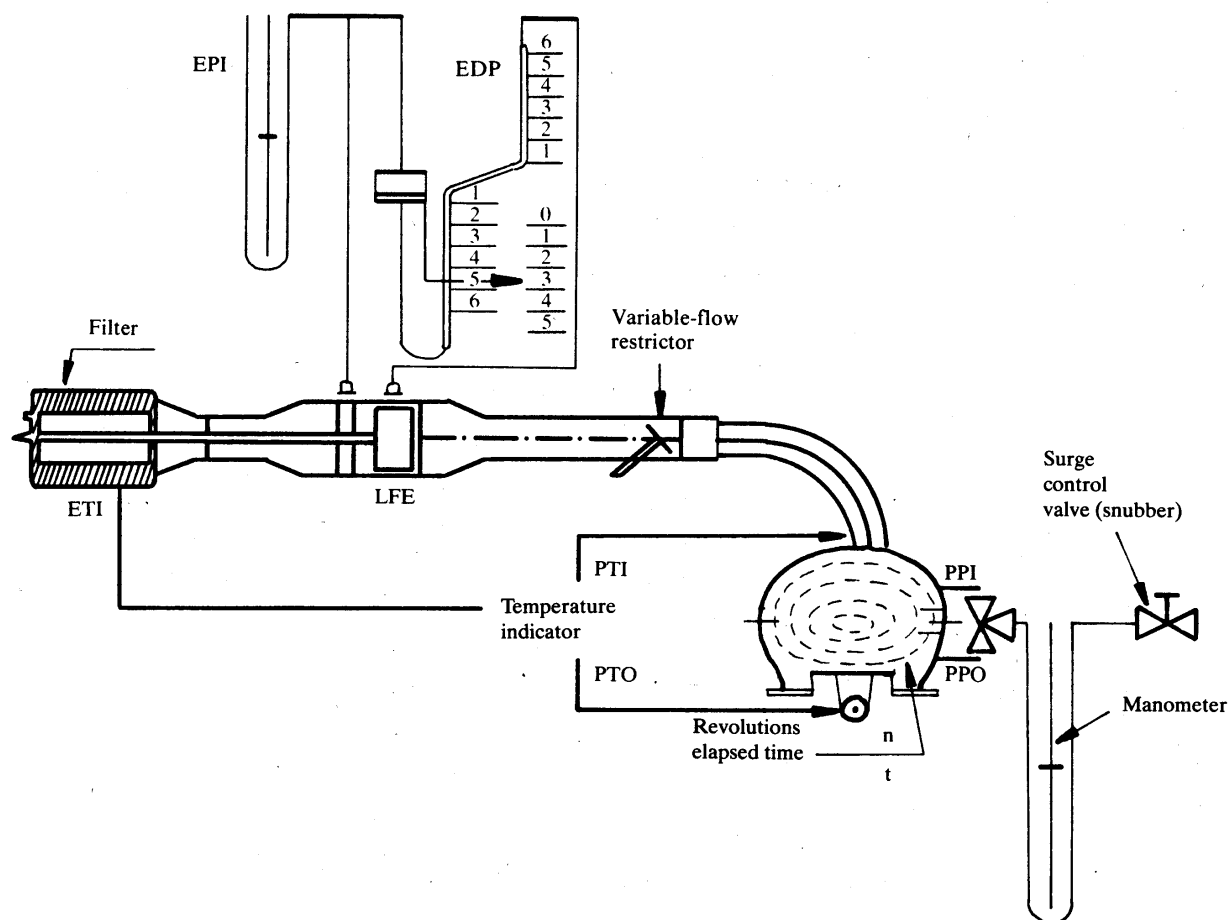

4.2.4. Data analysis

- 4.2.4.1. The air flow-rate (Q_s) at each test point is calculated in standard m^3/min from the flow-meter data using the manufacturer's prescribed method.
- 4.2.4.2. The air flow-rate is then converted to pump flow (V_o) in m^3/rev at absolute pump inlet temperature and pressure.

$$V_o = \frac{Q_s}{n} \cdot \frac{T_p}{273,2} \cdot \frac{101,33}{P_p}$$

where:

V_o = pump flow-rate at T_p and P_p given in m^3/rev ,

Q_s = air flow at 101,33 KPa and 273,2 K given in m^3/min ,

T_p = pump inlet temperature (K),

P_p = absolute pump inlet pressure,

n = pump speed in revolutions per minute.

▼ M4

Figure 3

CFV-CVS calibration configuration

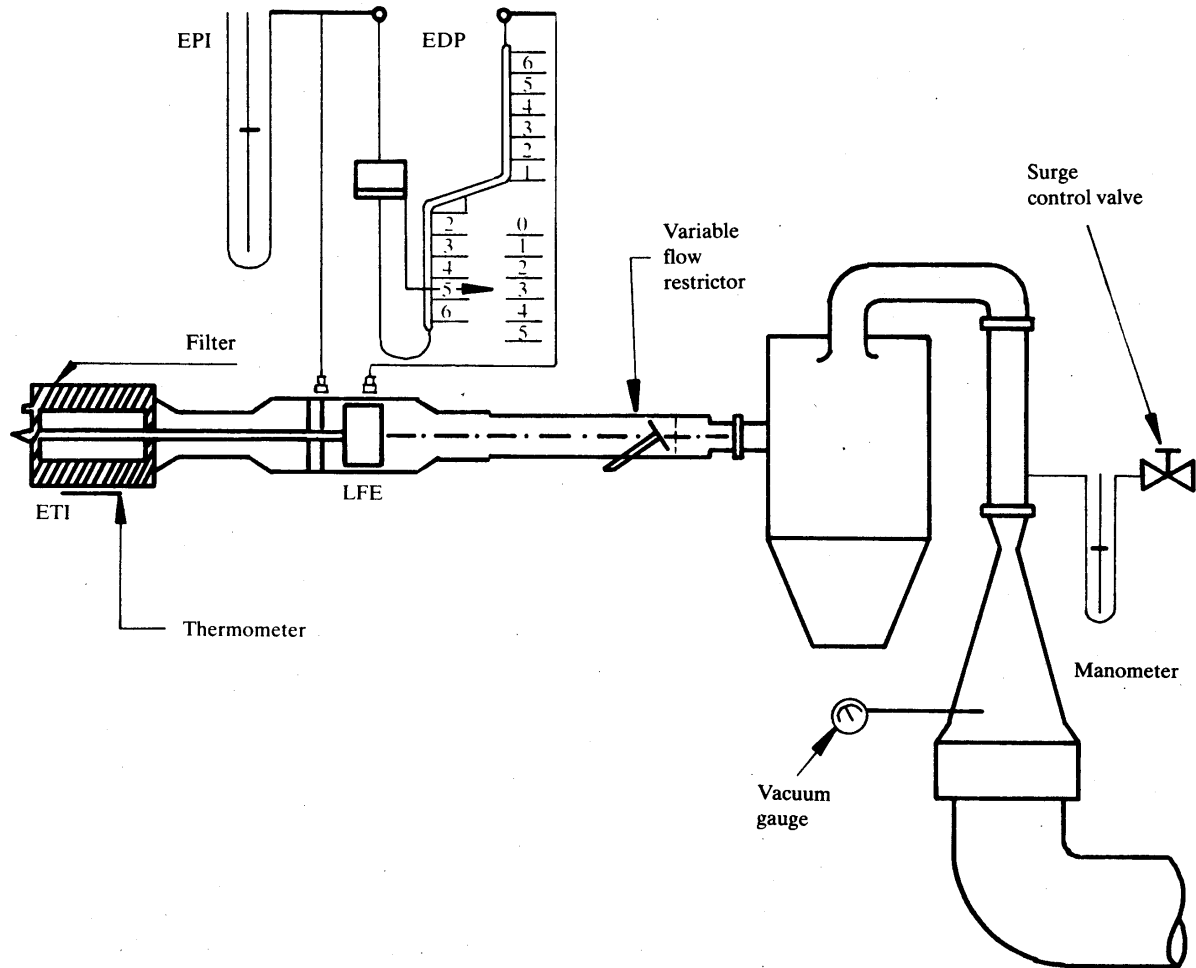

To compensate for the interaction of pump speed pressure variations at the pump and the pump slip rate, the correlation function (X_o) between the pump speed (n), the pressure differential from pump inlet to pump outlet and the absolute pump outlet pressure is then calculated as follows:

$$X_o = \frac{1}{n} \sqrt{\frac{\Delta P_p}{P_e}}$$

where:

x_o = correlation function,

ΔP_p = pressure differential from pump inlet to pump outlet (kPa),

P_e = absolute outlet pressure ($PPO + P_B$) (kPa).

A linear least-square fit is performed to generate the calibration equations which have the formulae:

$$V_o = D_o - M (X_o)$$

$$n = A - B (\Delta P_p)$$

D_o , M , A and B are the slope-intercept constants describing the lines.

4.2.4.3. A CVS system that has multiple speeds must be calibrated on each speed used. The calibration curves generated for the ranges must be approximately parallel and the intercept values (D_o) must increase as the pump flow range decreases.

If the calibration has been performed carefully, the calculated values from the equation will be within $\pm 0,5$ % of the measured value of V_o .

▼ **M4**

Values of M will vary from one pump to another. Calibration is performed at pump start-up and after major maintenance.

4.3. **Calibration of the critical-flow venturi (CFV)**

- 4.3.1. Calibration of the CFV is based upon the flow equation for a critical venturi:

$$Q_s = \frac{K_v \cdot P}{\sqrt{T}}$$

where:

- Q_s = flow,
 K_v = calibration coefficient,
 P = absolute pressure (kPa),
 T = absolute temperature (K).

Gas flow is a function of inlet pressure and temperature.

The calibration procedure described below establishes the value of the calibration coefficient at measured values of pressure, temperature and air flow.

- 4.3.2. The manufacturer's recommended procedure must be followed for calibrating electronic portions of the CFV.
- 4.3.3. Measurements for flow calibration of the critical flow venturi are required and the following data must be found within the limits of precision given:

barometric pressure (corrected) (P_B)	$\pm 0,03$ kPa,
LFE air temperature, flow-meter (ETI)	$\pm 0,15$ °C,
pressure depression upstream of LFE (EPI)	$\pm 0,01$ kPa,
pressure drop across (EDP) LFE matrix	$\pm 0,0015$ kPa,
air flow (Q_s)	$\pm 0,5$ %,
CFV inlet depression (PPI)	$\pm 0,02$ kPa,
temperature at venturi inlet (T_v)	$\pm 0,2$ °C.

- 4.3.4. The equipment must be set up as shown in Figure 3 and checked for leaks. Any leaks between the flow-measuring device and the critical-flow venturi seriously affect the accuracy of the calibration.
- 4.3.5. The variable-flow restrictor must be set to the open position, the blower started and the system stabilized. Data from all instruments must be recorded.
- 4.3.6. The flow restrictor must be varied and at least eight readings across the critical flow range of the venturi must be made.
- 4.3.7. The data recorded during the calibration must be used in the following calculations. The air flow-rate (Q_s) at each test point is calculated from the flow-meter data using the manufacturer's prescribed method.

Calculate values of the calibration coefficient for each test point:

$$K_v = \frac{Q_s \cdot \sqrt{T_v}}{P_v}$$

where:

- Q_s = flow-rate in m³/min at 273,2 K and 101,33 kPa,
 T_v = temperature at the venturi inlet (K),
 P_v = absolute pressure at the venturi inlet (kPa).

Plot K_v as a function of venturi inlet pressure. For sonic flow K_v will have a relatively constant value. As pressure decreases (vacuum increases) the venturi become unchoked and K_v decreases. The resultant K_v changes are not permissible.

For a minimum of eight points in the critical region calculate an average K_v and the standard deviation.

▼ M4

If the standard deviation exceeds 0,3 % of the average K_v take corrective action.

APPENDIX 7

TOTAL SYSTEM VERIFICATION

1. To comply with the requirements of 4.7 of Annex III, the total accuracy of the CVS sampling system and analytical system must be determined by introducing a known mass of a pollutant gas into the system whilst it is being operated as if during a normal test and then analyzing and calculating the pollutant mass according to the formulae in Appendix 8 to this Annex except that the density of propane is taken as 1,967 grams per litre at standard conditions. The following two techniques are known to give sufficient accuracy.
 2. **METERING A CONSTANT FLOW OF PURE GAS (CO OR C₃H₈) USING A CRITICAL FLOW ORIFICE DEVICE**
 - 2.1. A known quantity of pure gas (CO or C₃H₈) is fed into the CVS system through the calibrated critical orifice. If the inlet pressure is high enough, the flow-rate (q), which is adjusted by means of the critical flow orifice, is independent of orifice outlet pressure (critical flow). If deviations exceeding 5 % occur, the cause of the malfunction must be located and determined. The CVS system is operated as in an exhaust emission test for about 5 to 10 minutes. The gas collected in the sampling bag is analyzed by the usual equipment and the results compared to the concentration of the gas samples which was known beforehand.
3. **METERING A LIMITED QUANTITY OF PURE GAS (CO OR C₃H₈) BY MEANS OF A GRAVIMETRIC TECHNIQUE**
- 3.1. The following gravimetric procedure may be used to verify the CVS system. The weight of a small cylinder filled with either carbon monoxide or propane is determined with a precision of ± 0,01 g. For about 5 to 10 minutes, the CVS system is operated as in a normal exhaust emission test, while CO or propane is injected into the system. The quantity of pure gas involved is determined by means of differential weighing. The gas accumulated in the bag is then analyzed by means of the equipment normally used for exhaust-gas analysis. The results are then compared to the concentration figures computed previously.

▼ **M4***APPENDIX 8***CALCULATION OF THE MASS EMISSIONS OF POLLUTANTS**

The mass emissions of pollutants are calculated by means of the following equation:

$$M_i = V_{\text{mix}} \times Q_i \times k_H \times C_i \times 10^{-6} \quad (1)$$

where:

- M_i = mass emission of the pollutant i in grams per test,
 V_{mix} = volume of the diluted exhaust gas expressed in litres per test and corrected to standard conditions (273,2 K and 101,33 kPa),
 Q_i = density of the pollutant i in grams per litre at normal temperature and pressure (273,2 K and 101,33 kPa),
 k_H = humidity correction factor used for the calculation of the mass emissions of oxides of nitrogen. There is no humidity correction for HC and CO,
 C_i = concentration of the pollutant i in the diluted exhaust gas expressed in ppm and corrected by the amount of the pollutant i contained in the dilution air.

1. VOLUME DETERMINATION

- 1.1. Calculation of the volume when a variable dilution device with constant flow control by orifice or venturi is used. Record continuously the parameters showing the volumetric flow, and calculate the total volume for the duration of the test.
- 1.2. Calculation of volume when a positive displacement pump is used. The volume of diluted exhaust gas in systems comprising a positive displacement pump is calculated with the following formula:

$$V = V_o \times N$$

where:

- V = volume of the diluted exhaust gas expressed in litres per test (prior to correction),
 V_o = volume of gas delivered by the positive displacement pump on testing conditions in litres per revolution,
 N = number of revolutions per test.

1.3. Correction of the diluted exhaust-gas volume to standard conditions

The diluted exhaust-gas volume is corrected by means of the following formula:

$$V_{\text{mix}} = V \times K_1 \times \frac{P_B - P_1}{T_p} \quad (2)$$

in which:

$$K_1 = \frac{273,2 \text{ K}}{101,33 \text{ kPa}} = 2,6961 \text{ (K} \times \text{kPa}^{-1}) \quad (3)$$

where:

- P_B = barometric pressure in the test room in kPa,
 P_1 = vacuum at the inlet to the positive displacement pump in kPa relative to the ambient barometric pressure,
 T_p = average temperature of the diluted exhaust gas entering the positive displacement pump during the test (K).

▼ **M4**

2. CALCULATION OF THE CORRECTED CONCENTRATION OF POLLUTANTS IN THE SAMPLING BAG

$$C_i = C_e - C_d \left(1 - \frac{1}{DF} \right) \quad (4)$$

where:

C_i = concentration of the pollutant i in the diluted exhaust gas, expressed in ppm and corrected by the amount of i contained in the dilution air,

C_e = measured concentration of pollutant i in the diluted exhaust gas, expressed in ppm,

C_d = measured concentration of pollutant i in the air used for dilution, expressed in ppm,

DF = dilution factor.

The dilution factor is calculated as follows:

$$DF = \frac{13,4}{c_{CO_2} + (c_{HC} + c_{CO}) 10^{-4}} \quad (5)$$

In this equation:

c_{CO_2} = concentration of CO_2 in the diluted exhaust gas contained in the sampling bag, expressed in % volume,

c_{HC} = concentration of HC in the diluted exhaust gas contained in the sampling bag, expressed in ppm carbon equivalent,

c_{CO} = concentration of CO in the diluted exhaust gas contained in the sampling bag, expressed in ppm.

3. DETERMINATION OF THE NO HUMIDITY CORRECTION FACTOR

In order to correct the influence of humidity on the results of oxides of nitrogen, the following calculations are applied:

$$k_H = \frac{1}{1 - 0,0329 (H - 10,71)} \quad (6)$$

in which:

$$H = \frac{6,211 \times R_a \times P_d}{P_B - P_d \times R_a \times 10^{-2}} \quad (6)$$

where:

H = absolute humidity expressed in grams of water per kilogram of dry air,

R_a = relative humidity of the ambient air expressed as a percentage,

P_d = saturation vapour pressure at ambient temperature expressed in kPa,

P_B = atmospheric pressure in the room, expressed in kPa.

4. EXAMPLE

4.1. Data

4.1.1. Ambient conditions:

ambient temperature: 23 °C = 296,2 K,

barometric pressure: $P_B = 101,33$ kPa,

relative humidity: $R_a = 60$ %,

saturation vapour pressure: $P_d = 3,20$ kPa of H_2O at 23 °C.

4.1.2. Volume measured and reduced to standard conditions (paragraph 1)

$V = 51,961$ m³

▼ **M4**

4.1.3. Analyzer readings:

	Diluted exhaust sample	Dilution-air sample
HC ⁽¹⁾	92 ppm	3,0 ppm
CO	470 ppm	0 ppm
NO _x	70 ppm	0 ppm
CO ₂	1,6 % vol	0,03 % vol

⁽¹⁾ In ppm carbon equivalent.

4.2. **Calculation**4.2.1. Humidity correction factor (k_H) (see formulae (6))

$$H = \frac{6,211 \times R_a \times P_d}{P_B - P_d \times R_a \times 10^{-2}}$$

$$H = \frac{6,211 \times 60 \times 3,2}{101,33 - (3,2 \times 0,60)}$$

$$H = 11,9959$$

$$k_H = \frac{1}{1 - 0,0329 \times (H - 10,71)}$$

$$k_H = \frac{1}{1 - 0,0329 \times (11,9959 - 10,71)}$$

$$k_H = 1,0442$$

4.2.2. Dilution factor (DF) (see formula (5))

$$DF = \frac{13,4}{c_{CO_2} + (c_{HC} + c_{CO}) \times 10^{-4}}$$

$$DF = \frac{13,4}{1,6 + (92 + 4,70) \times 10^{-4}}$$

$$DF = 8,091$$

4.2.3. Calculation of the corrected concentration of pollutants in the sampling bag:

HC, mass emissions (see formulae (4) and (1))

$$C_i = C_e - C_d \left(1 - \frac{1}{DF}\right)$$

$$C_i = 92 - 3 \left(1 - \frac{1}{8,091}\right)$$

$$C_i = 89,371$$

$$M_{HC} = C_{HC} \times V_{mix} \times Q_{HC}$$

$$Q_{HC} = 0,619$$

$$M_{HC} = 89,371 \times 51961 \times 0,619 \times 10^{-6}$$

▼ **M4**

$$M_{\text{HC}} = 2,88 \frac{\text{g}}{\text{test}}$$

CO, mass emissions (see formula (1))

$$M_{\text{CO}} = C_{\text{CO}} \times V_{\text{mix}} \times Q_{\text{CO}}$$

$$Q_{\text{CO}} = 1,25$$

$$M_{\text{CO}} = 470 \times 51\,961 \times 1,25 \times 10^{-6}$$

$$M_{\text{CO}} = 30,5 \frac{\text{g}}{\text{test}}$$

NO_x, mass emissions (see formula (1))

$$M_{\text{NO}_x} = C_{\text{NO}_x} \times V_{\text{mix}} \times Q_{\text{NO}_x} \times k_{\text{H}}$$

$$Q_{\text{NO}_x} = 2,05$$

$$M_{\text{NO}_x} = 70 \times 51\,961 \times 2,05 \times 1,0442 \times 10^{-6}$$

$$M_{\text{NO}_x} = 7,79 \frac{\text{g}}{\text{test}}$$

4.3. HC measurements with diesel engines

To calculate HC-mass emissions for diesel engines the average HC concentration is calculated as follows:

$$c_e = \frac{\int_{t_1}^{t_2} c_{\text{HC}} \cdot dt}{t_2 - t_1} \quad (7)$$

where:

$\int_{t_1}^{t_2} c_{\text{HC}} \cdot dt$ = integral of the recording of the heated FID over the test ($t_2 - t_1$),

c_e = concentration of HC measured in the diluted exhaust in ppm of C₁,

c_e is substituted directly for C_{HC} in all relevant equations.

4.4. Example of a calculation

4.4.1. Data

Ambient conditions

ambient temperature	23 °C	= 296,2 K
barometric pressure	P _B	= 101,33 kPa
relative humidity	R _a	= 60 %
saturation vapour pressure of H ₂ O at 23 °C	P _d	= 3,20 kPa

Positive displacement pump (PDP)

pump volume (from calibration data)	V _o	= 2,439 litres per revolution
vacuum	P _i	= 2,80 kPa
gas temperature	T _p	= 51 °C = 324,2 K
number of pump revolutions	n	= 26 000

▼ **M4***Analyzer readings*

	Diluted exhaust sample	Dilution-air sample
HC	92 ppm	3,0 ppm
CO	470 ppm	0 ppm
NO _x	70 ppm	0 ppm
CO ₂	1,6 % vol	0,03 % vol

4.4.2. *Calculation*

4.4.2.1. Gas volume (see formula (2))

$$V_{\text{mix}} = K_1 \times V_o \times n \frac{P_B - P_i}{T_p}$$

$$V_{\text{mix}} = 2,6961 \times 2,439 \times 26\,000 \times \frac{98,53}{324,2}$$

$$V_{\text{mix}} = 51\,960,89$$

Note

For CFV and similar CVS systems the volume may be read directly from the instrumentation.

4.4.2.2. Humidity correction factor (kH) (see formula (6))

$$H = \frac{6,211 \times R_a \times P_d}{P_B - \left(P_d \times \frac{R_a}{100} \right)}$$

$$H = \frac{6,211 \times 60 \times 3,2}{101,33 - (3,2 \times 0,60)}$$

$$H = 11,99589$$

$$k_H = \frac{1}{1 - 0,0329 \times (H - 10,71)}$$

$$k_H = \frac{1}{1 - 0,0329 \times (11,9959 - 10,71)}$$

$$k_H = 1,0442$$

4.4.2.3. Dilution factor (DF) (see formula (5))

$$DF = \frac{13,4}{c_{\text{CO}_2} + (c_{\text{HC}} + c_{\text{CO}}) 10^{-4}}$$

$$DF = \frac{13,4}{1,6 + (92,0 + 470) 10^{-4}}$$

$$DF = 8,091$$

4.4.2.4. Calculation of the corrected concentration of pollutants in the sampling bag

HC, mass emissions (see formulae (4) and (1))

$$C_i = C_e - C_d \left(1 - \frac{1}{DF} \right)$$

$$C_i = 92,0 - 3 \left(1 - \frac{1}{8,091} \right)$$

▼ M4

$$C_i = 89,372$$

$$M_{HC} = C_{HC} \times V_{mix} \times Q_{HC}$$

$$Q_{HC} = 0,619$$

$$M_{HC} = 89,372 \times 51\,961 \times 0,619 \times 10^{-6}$$

$$M_{HC} = 2,87 \text{ g/test HC}$$

▼M5

ANNEX IIIA

TEST EQUIVALENT TO THE TYPE I TEST FOR VERIFYING EMISSIONS AFTER A COLD START

1. INTRODUCTION

See section 8.3 of Annex I.
2. OPERATING CYCLE ON THE CHASSIS DYNAMOMETER
 - 2.1. **Description of the cycle**

The operating cycle to be applied on the chassis dynamometer is that indicated in the following table and depicted in the graph in Appendix 1. The breakdown by operations is also given in that table.
 - 2.2. *Idem* section 2.2 of Annex III.
 - 2.3. **Transmissions**
 - 2.3.1. All test conditions, except as noted, will be run according to the manufacturer's recommendations.
 - 2.3.2. Vehicles equipped with free wheeling or overdrive, except as noted, will be tested with these features operated according to the manufacturer's recommendations.
 - 2.3.3. Idle modes are to be run with automatic transmission in 'drive' and the wheels braked: manual transmissions to be in gear with the clutch disengaged, except in the first idle mode.

The vehicle must be driven with minimum accelerator pedal movement to maintain the desired speed.
 - 2.3.4. Acceleration must be smooth, following representative gear speeds and procedures. For manual transmissions, the operator must release the accelerator pedal during each gear change and complete the change in the minimum amount of time. If the vehicle cannot accelerate at the specified rate, it is to be operated at maximum available power until its speed reaches the value prescribed for that time in the driving schedule.
 - 2.3.5. The deceleration modes must be run in gear using brakes or accelerator pedal as necessary to maintain the desired speed. Manual transmission vehicles must have the clutch engaged and must not change gears from the previous mode. For those modes which decelerate to zero, manual transmission clutches must be depressed when the speed drops below 24,1 km/h, when engine roughness is evident, or when engine stalling is imminent.
 - 2.3.6. *Manual transmission*
 - 2.3.6.1. In the case of test vehicles equipped with manual transmission, the transmission must be shifted according to the procedures recommended by the manufacturer, subject to the agreement of the technical service responsible for the tests.
 - 2.4. **Tolerances**
 - 2.4.1. The dynamometer driving schedule is listed in Appendix 1. The driving schedule is defined by a smooth trace drawn through the specified speed versus time relationships. It consists of a non +repetitive series of idle, acceleration, cruise, and deceleration modes of various time sequences and rates.
 - 2.4.2. The speed tolerances are:
 - the upper limit is 3,2 km/h higher than the highest point on the trace within one second of the given time,
 - the lower limit is 3,2 km/h lower than the lowest point on the trace within one second of the given time,
 - speed variations greater than the tolerances (such as may occur during gear changes) are acceptable provided they do not occur for more than 2 seconds on any occasion,

▼ **M5**

- speeds lower than those prescribed are acceptable provided the vehicle is operated at maximum available power during such occurrences,
- the speed tolerance must be as specified above, except the upper and lower limits which are 6,4 km/h,
- the following figures show the range of acceptable speed tolerances for typical points. Figure A is typical of portions of the speed curve which are increasing or decreasing throughout the 2 s time interval. Figure B is typical of portions of the speed curve which include a maximum or minimum.

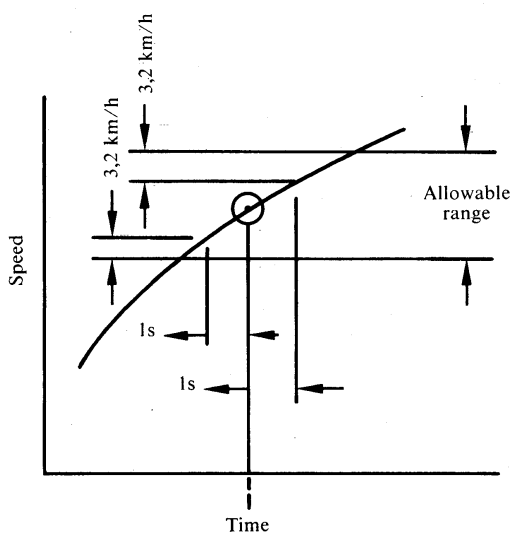

Figure A

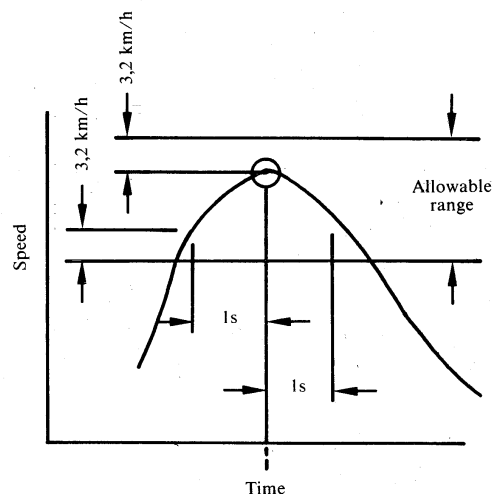

Figure B

3. VEHICLE AND FUEL

3.1. Test vehicles

- | | | |
|--|---|---|
| 3.1.1.
3.1.2.
3.1.3.
3.1.4.
3.1.5.
3.1.6. | } | <i>Idem</i> sections 3.1.1 to 3.1.6 of Annex III. |
|--|---|---|

3.2. Fuel

The appropriate reference fuel as defined in Annex VI must be used for testing, or the equivalent reference fuels used by the competent authorities in Community export markets.

4. TEST EQUIPMENT

4.1. Chassis dynamometer

- 4.1.1. *Idem* section 4.1.1 of Annex III but add the following subparagraph: 'Dynamometers with adjustable load curve may be considered as having a fixed load curve if they meet the requirements of a fixed load curve dynamometer and are used as a fixed load curve dynamometer.'

- | | | |
|------------------|---|---|
| 4.1.2.
4.1.3. | } | <i>Idem</i> sections 4.1.1, 4.1.2 and 4.1.3 of Annex III. |
|------------------|---|---|

4.1.4. Accuracy

- 4.1.4.1. *Idem* 4.1.4.1 Annex III.

▼ **M5**

4.1.4.2. In the case of a dynamometer with a fixed load curve, the accuracy of matching dynamometer load to road must be 5 % at 80,5 km/h.

In the case of a dynamometer with adjustable load curve, the accuracy of matching dynamometer load to road must be 5 % at 80,5 km/h, 60 and 40 km/h and 10 % at 20 km/h. Below this, dynamometer absorption must be positive.

4.1.4.3. }
4.1.4.4. } *Idem* sections 4.1.4.3 and 4.1.4.4 of Annex III.

4.1.5. *Load and inertia setting*

4.1.5.1. Dynamometers with fixed load curve: the load simulator must be adjusted to absorb the power exerted on the driving wheels at a steady speed of 80,5 km/h. The alternative means by which this load is determined and set are described in Appendix 2, section 3 and Appendix 3.

4.1.5.2. Dynamometers with adjustable load curve: the load simulator must be adjusted in order to absorb the power exerted on the driving wheels at steady speeds of 20, 40, 60 and 80,5 km/h. The means by which these loads are determined and set are described in Appendix 2, point 3 and Appendix 3.

4.1.5.3. *Idem* section 4.1.5.3 of Annex III.

4.2. }
4.3. }
4.4. } *Idem* sections 4.2 to 4.7 of Annex III.
4.5. }
4.6. }
4.7. }

5. **PREPARING THE TEST**

5.1. **Adjustment of inertia simulators to the vehicle's translatory inertias**

Reference mass of the vehicle (kg)	Equivalent inertia mass (kg)
$Pr \leq 480$	450
$480 < Pr \leq 540$	510
$540 < Pr \leq 600$	570
$600 < Pr \leq 650$	620
$650 < Pr \leq 710$	680
$710 < Pr \leq 770$	740
$770 < Pr \leq 820$	800
$820 < Pr \leq 880$	850
$880 < Pr \leq 940$	910
$940 < Pr \leq 990$	960
$990 < Pr \leq 1\ 050$	1\ 020
$1\ 050 < Pr \leq 1\ 110$	1\ 080
$1\ 110 < Pr \leq 1\ 160$	1\ 130
$1\ 160 < Pr \leq 1\ 220$	1\ 190
$1\ 220 < Pr \leq 1\ 280$	1\ 250
$1\ 280 < Pr \leq 1\ 330$	1\ 300
$1\ 330 < Pr \leq 1\ 390$	1\ 360
$1\ 390 < Pr \leq 1\ 450$	1\ 420
$1\ 450 < Pr \leq 1\ 500$	1\ 470
$1\ 500 < Pr \leq 1\ 560$	1\ 530
$1\ 560 < Pr \leq 1\ 620$	1\ 590
$1\ 620 < Pr \leq 1\ 670$	1\ 640
$1\ 670 < Pr \leq 1\ 730$	1\ 700
$1\ 730 < Pr \leq 1\ 790$	1\ 760
$1\ 790 < Pr \leq 1\ 870$	1\ 810
$1\ 870 < Pr \leq 1\ 980$	1\ 930
$1\ 980 < Pr \leq 2\ 100$	2\ 040
$2\ 100 < Pr \leq 2\ 210$	2\ 150

▼ **M5**

Reference mass of the vehicle (kg)	Equivalent inertia mass (kg)
2 210 < Pr ≤ 2 320	2 270
2 320 < Pr ≤ 2 440	2 380
2 440 < Pr	2 490

Flywheels, electrical or other means of simulating test mass as shown in the table may be used. If the equivalent test mass specified is not available on the dynamometer being used, the next higher equivalent test mass (not exceeding 115 kg) available is to be used.

Note:

The reference mass of the vehicle is the mass of the vehicle in running order less the uniform mass of the driver and increased by a uniform mass of 136 kg.

5.2. *Idem* section 5.2 of Annex III.

5.3. **Conditioning of vehicle**

5.3.1. Before the test, the vehicle must be kept in a room in which the temperature remains relatively constant between 20 and 30 °C.

This conditioning must continue for at least six hours if the engine oil temperature is measured or for at least 12 hours if it is not.

If the manufacturer so requests, the test must be carried out not later than 36 hours after the vehicle has been run at its normal temperature.

5.3.2. *Idem* section 5.3.2 of Annex III.

6. **PROCEDURE FOR BENCH TESTS**

6.1. }
 6.1.2. } *Idem* sections 6.1 to 6.1.4 of Annex III.
 6.1.3. }
 6.1.4. }

6.2. **Test and sampling**

6.2.1. The vehicle must be stored prior to the emission test in such a manner that precipitation (e.g., rain or dew) does not occur on the vehicle. The complete dynamometer test consists of a cold start drive of 12,1 km and simulates a hot start drive of 12,1 km. The vehicle is allowed to stand on the dynamometer during the 10 +minute time period between the cold and hot start tests. The cold start test is divided into two periods. The first period, representing the cold start 'transient' phase, terminates at the end of the deceleration which is scheduled to occur at 505 seconds of the driving schedule. The second period, representing the 'stabilized' phase, consists of the remainder of the driving schedule including engine shutdown. The hot start test similarly consists of two periods. The first period, representing the hot start 'transient' phase, terminates at the same point in the driving schedule as the first period of the cold start test. The second period of the hot start test, 'stabilized' phase, is assumed to be identical to the second period of the cold start test. Therefore the hot start test terminates after the first period (505 seconds) is run.

6.2.2. The following steps shall be taken for each test:

6.2.2.1. Place drive wheels of vehicle on dynamometer without starting engine. Reset and enable the roll revolution counter.

6.2.2.2. Open the vehicle engine compartment cover and position the cooling fan.

6.2.2.3. With the sample selector valves in the 'standby' position, connect evacuated sample collection bags to the dilute exhaust and dilution air sample collection systems.

▼ **M5**

- 6.2.2.4. Start the CVS (constant volume sampler) (if not already on), the sample pumps, the temperature recorder, the vehicle cooling fan and the heated hydrocarbon analysis recorder (diesel only). (The heat exchanger of the constant volume sampler if used, should be preheated to its operating temperature.) The diesel hydrocarbon analyser continuous sample line and filter (if applicable) should be preheated to $190\text{ °C} \pm 10\text{ °C}$.
- 6.2.2.5. Adjust the sample flowrates to the desired flowrate (minimum of $0,28\text{ m}^3/\text{h}$) and set the gas flow measuring devices to zero.
- Note:*
CFV +CVS sample flowrate is fixed by the venturi design.
- 6.2.2.6. Attach the flexible exhaust tube to the vehicle tailpipe(s).
- 6.2.2.7. Start the gas flow measuring device, position the sample selector valves to direct the sample flow into the 'transient' exhaust sample bag and the 'transient' dilution air sample bag (turn on the diesel hydrocarbon analyser system integrator and mark the recorder chart, if applicable), turn the ignition key on and start the engine.
- 6.2.2.8. Fifteen seconds after the engine starts, place the transmission in gear.
- 6.2.2.9. Twenty seconds after the engine starts, begin the initial vehicle acceleration of the driving schedule.
- 6.2.2.10. Operate the vehicle according to the dynamometer driving schedule.
- 6.2.2.11. At the end of the deceleration which is scheduled to occur at 505 seconds, simultaneously switch the sample flows from the 'transient' bags to the 'stabilized' bags, switch off gas flow measuring device No 1 (and the diesel hydrocarbon integrator No 1, mark the diesel hydrocarbon recorder chart) and start gas flow measuring device No 2 (and diesel hydrocarbon integrator No 2). Before the acceleration which is scheduled to occur at 510 seconds, record the measured roller or shaft revolutions and reset the counter or switch to a second counter. As soon as possible transfer the 'transient' exhaust and dilution air samples to the analytical system and process the samples so as to obtain a stabilized reading of the exhaust sample on all analysers within 20 minutes of the end of the sample collection part of the test.
- 6.2.2.12. Turn the engine off 2 seconds after the end of the last deceleration (at 1 369 seconds).
- 6.2.2.13. Five seconds after the engine stops running, simultaneously turn off gas flow measuring device No 2 (the diesel hydrocarbon integrator No 2 and mark the hydrocarbon recorder chart, if applicable) and position the sample selector valves to the 'standby' position. Record the measured roller or shaft revolutions and reset the counter. As soon as possible transfer the 'stabilized' exhaust and dilution air samples to the analytical system and process the samples in order to obtain a stabilized reading of the exhaust sample on all analysers within 20 minutes of the end of the sample collection part of the test.
- 6.2.2.14. Immediately after the end of the sample period turn off the cooling fan and close the engine compartment cover.
- 6.2.2.15. Turn off the CVS or disconnect the exhaust tube from the tailpipe of the vehicle.
- 6.2.2.16. Repeat the steps in sections 6.2.2.2 to 6.2.2.10 for the hot start test, except that only one evacuated sample bag is required for sampling exhaust gas and one for dilution air. The key +on operation step described in section 6.2.2.7 begins between 9 and 11 minutes after the end of the sample period for the cold start test.
- 6.2.2.17. At the end of the deceleration which is scheduled to occur at 505 seconds, simultaneously turn off gas flow measuring device No 1 (and diesel hydrocarbon integrator No 1, mark the diesel hydrocarbon recorder chart, if applicable) and position the sample selector valve to the 'standby' position (engine shutdown is not part of the hot start test sample period). Record the measured roller or shaft revolutions.
- 6.2.2.18. As soon as possible transfer the hot start 'transient' exhaust and dilution air samples to the analytical system and process the samples in order to obtain a stabilized reading of the exhaust

▼ **M5**

sample on all analysers within 20 minutes of the end of the sample collection part of the test.

6.3. **Engine starting and restarting**

6.3.1. *Petrol +engined vehicles*

This section applies to petrol +engined vehicles.

6.3.1.1. The engine must be started according to the manufacturer's instructions as set out in the handbook for series +produced vehicles. The initial 20 +second idle period begins when the engine starts.

6.3.1.2. **Choke operation**

Vehicles equipped with automatic chokes must be operated according to the manufacturer's instructions as set out in the handbook for series +produced vehicles.

Vehicles equipped with manual chokes must be operated according to the manufacturer's instructions as set out in the handbook for series +produced vehicles.

6.3.1.3. The transmission must be placed in gear 15 seconds after the engine is started. If necessary, braking may be employed to keep the drive wheels from turning.

6.3.1.4. The operator may use the choke, accelerator pedal, etc. where necessary to keep the engine running.

6.3.1.5. If the manufacturer's instructions as set out in the handbook for series +produced vehicles do not specify a warm engine starting procedure, the engine (automatic +and +manual +choke engines) must be started by depressing the accelerator pedal about half way and letting the engine turn over until it starts.

6.3.2. *Diesel vehicles*

The engine must be started according to the manufacturer's instructions as set out in the handbook for series +produced vehicles. The initial 20 +second idle period begins when the engine starts. The transmission must be placed in gear 15 seconds after the engine is started. If necessary, braking may be employed to keep the drive wheels from turning.

6.3.3. If the vehicle does not start after 10 seconds' use of the starter, the attempt is to cease and the reason for failure to start determined. The gas flow measuring device on the constant volume sampler (usually a revolution counter) or CFV (and the hydrocarbon integrator when testing diesel vehicles) must be turned off and the sampler selector valves placed in the 'standby' position during this diagnostic period. In addition, either the CVS should be turned off, or the exhaust tube disconnected from the tailpipe during the diagnostic period. If failure to start is due to an operational error, the vehicle must be rescheduled for testing from a cold start.

6.3.3.1. If a failure to start occurs during the cold portion of the test and is caused by a vehicle malfunction, corrective action of less than 30 minutes duration may be taken and the test continued. All sampling system(s) must be reactivated at the same time as the engine begins to turn. When the engine starts, the driving schedule timing sequence begins. If failure to start is caused by vehicle malfunction and the vehicle cannot be started, the test is void.

6.3.3.2. If a failure to start occurs during the hot start portion of the test and is caused by vehicle malfunction, the vehicle must be started within one minute of key on. All sampling system(s) must be reactivated at the same time as the engine begins to turn. When the engine starts, the driving schedule timing sequence begins. If the vehicle cannot be started within one minute of key on, the test is void.

6.3.4. If the engine 'false starts' the operator must repeat the recommended starting procedure (such as resetting the choke, etc.).

▼ M5

- 6.3.5. *Stalling* ⁽¹⁾
- If the engine stalls during an idle period, the engine must be restarted immediately and the test continued. If the engine cannot be started soon enough to allow the vehicle to follow the next acceleration as prescribed, the driving schedule indicator must be stopped. When the vehicle restarts, the driving schedule indicator must be reactivated.
7. PROCEDURE FOR ANALYSES
- 7.1. *Idem* section 7.2.2 of Annex III.
- 7.2. *Idem* section 7.2.3 of Annex III.
- 7.3. *Idem* section 7.2.4 of Annex III.
- 7.4. *Idem* section 7.2.5 of Annex III.
- 7.5. *Idem* section 7.2.6 of Annex III.
- 7.6. *Idem* section 7.2.7 of Annex III.
- 7.7. *Idem* section 7.2.8 of Annex III.
8. DETERMINATION OF THE QUANTITY OF GASEOUS POLLUTANTS
- 8.1. } *Idem* sections 8.1 and 8.2 of Annex III.
- 8.2. }

⁽¹⁾ If the engine stalls during some operating mode other than idle, the driving schedule must be stopped; the vehicle is then restarted and accelerated to the speed required at that point in the driving schedule and the test continued.
If the vehicle will not restart within one minute, the test is void.

▼M5

Appendix 1

OPERATING CYCLE

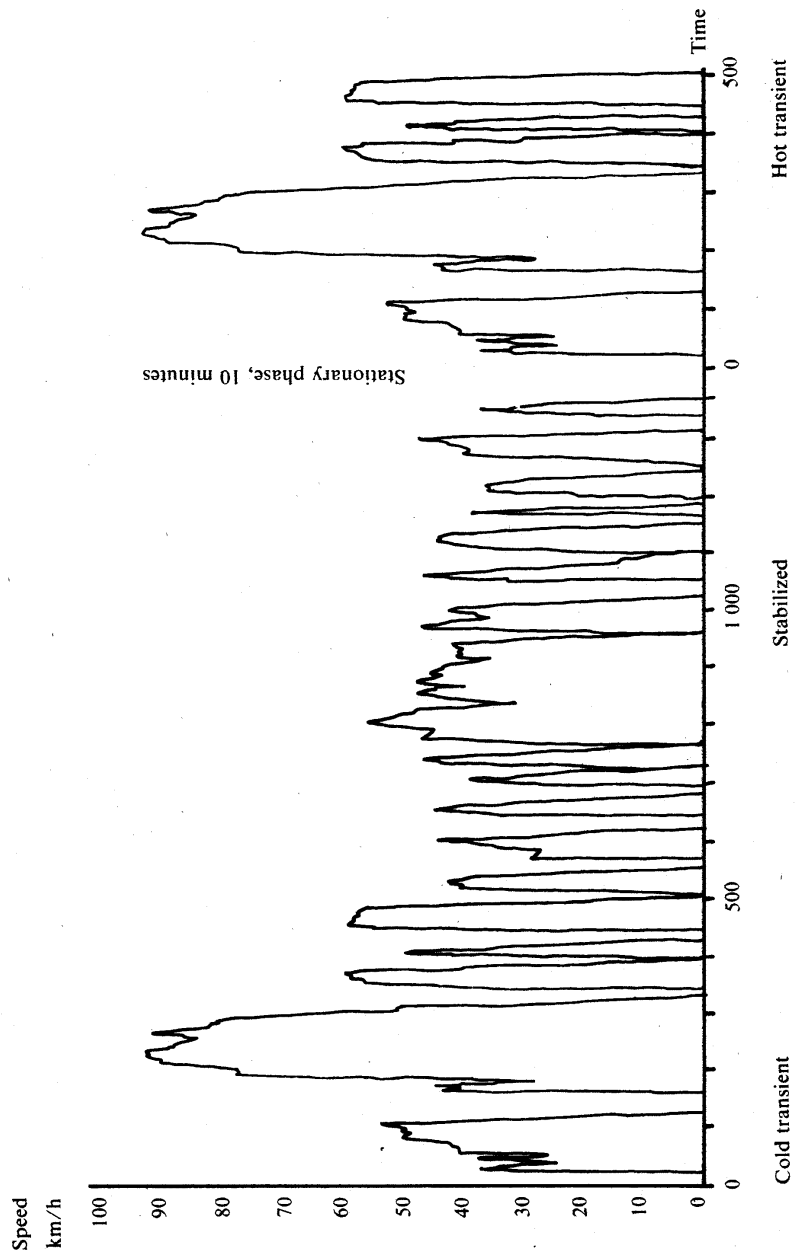

▼ M5

t	v
0	0,0
1	0,0
2	0,0
3	0,0
4	0,0
5	0,0
6	0,0
7	0,0
8	0,0
9	0,0
10	0,0
11	0,0
12	0,0
13	0,0
14	0,0
15	0,0
16	0,0
17	0,0
18	0,0
19	0,0
20	0,0
21	4,8
22	9,5
23	13,8
24	16,5
25	23,0
26	27,2
27	27,8
28	29,1
29	33,3
30	34,9
31	36,0
32	36,2
33	35,6
34	34,6
35	33,6
36	32,8
37	31,9
38	27,4
39	24,0
40	24,0
41	24,5
42	24,9
43	25,7
44	27,5
45	30,7
46	34,0
47	36,5
48	36,9
49	36,5
50	36,4
51	34,3
52	30,6
53	27,5
54	25,4
55	25,4
56	28,5
57	31,9
58	34,8
59	37,3
60	38,9
61	39,6
62	40,1
63	40,2
64	39,6
65	39,4
66	39,8

▼ M5

t	v
67	39,9
68	39,8
69	39,6
70	39,6
71	40,4
72	41,2
73	41,4
74	40,9
75	40,1
76	40,2
77	40,9
78	41,8
79	41,8
80	41,4
81	42,0
82	43,0
83	44,3
84	46,0
85	47,2
86	48,0
87	48,4
88	48,9
89	49,4
90	49,4
91	49,1
92	48,9
93	48,8
94	48,9
95	49,6
96	48,9
97	48,1
98	47,5
99	48,0
100	48,8
101	49,4
102	49,7
103	49,9
104	49,7
105	48,9
106	48,0
107	48,1
108	48,6
109	49,4
110	50,2
111	51,2
112	51,8
113	52,1
114	51,8
115	51,0
116	46,0
117	40,7
118	35,4
119	30,1
120	24,8
121	19,5
122	14,2
123	8,9
124	3,5
125	0,0
126	0,0
127	0,0
128	0,0
129	0,0
130	0,0
131	0,0
132	0,0
133	0,0

▼ M5

t	v
134	0,0
135	0,0
136	0,0
137	0,0
138	0,0
139	0,0
140	0,0
141	0,0
142	0,0
143	0,0
144	0,0
145	0,0
146	0,0
147	0,0
148	0,0
149	0,0
150	0,0
151	0,0
152	0,0
153	0,0
154	0,0
155	0,0
156	0,0
157	0,0
158	0,0
159	0,0
160	0,0
161	0,0
162	0,0
163	0,0
164	5,3
165	10,6
166	15,9
167	21,2
168	26,6
169	31,9
170	35,7
171	39,1
172	41,5
173	42,5
174	41,4
175	40,4
176	39,8
177	40,2
178	40,6
179	40,9
180	41,5
181	43,8
182	42,6
183	38,6
184	36,5
185	31,2
186	28,5
187	27,7
188	29,1
189	29,9
190	32,2
191	35,7
192	39,4
193	43,9
194	49,1
195	53,9
196	58,3
197	60,0
198	63,2
199	65,2
200	67,8

▼ M5

t	v
201	70,0
202	72,6
203	74,0
204	75,3
205	76,4
206	76,4
207	76,1
208	76,0
209	75,6
210	75,6
211	75,6
212	75,6
213	75,6
214	76,0
215	76,3
216	77,1
217	78,1
218	79,0
219	79,7
220	80,5
221	81,4
222	82,1
223	82,9
224	84,0
225	85,6
226	87,1
227	87,9
228	88,4
229	88,5
230	88,4
231	87,9
232	87,9
233	88,2
234	88,7
235	89,3
236	89,6
237	90,3
238	90,6
239	91,1
240	91,2
241	91,2
242	90,9
243	90,9
244	90,9
245	90,9
246	90,9
247	90,9
248	90,8
249	90,3
250	89,8
251	88,7
252	87,9
253	87,2
254	86,9
255	86,4
256	86,3
257	86,7
258	86,9
259	87,1
260	87,1
261	86,6
262	85,9
263	85,3
264	84,7
265	83,8
266	84,3
267	83,7

▼M5

t	v
268	83,5
269	83,2
270	82,9
271	83,0
272	83,4
273	83,8
274	84,5
275	85,3
276	86,1
277	86,9
278	88,4
279	89,2
280	89,5
281	90,1
282	90,1
283	89,8
284	88,8
285	87,7
286	86,3
287	84,5
288	82,9
289	82,9
290	82,9
291	82,2
292	80,6
293	80,5
294	80,6
295	80,5
296	79,8
297	79,7
298	79,7
299	79,7
300	79,0
301	78,2
302	77,4
303	76,0
304	74,2
305	72,4
306	70,5
307	68,6
308	66,8
309	64,9
310	62,0
311	59,5
312	56,6
313	54,4
314	52,3
315	50,7
316	49,2
317	49,1
318	48,3
319	46,7
320	44,3
321	39,9
322	34,6
323	32,3
324	30,7
325	29,8
326	27,4
327	24,9
328	20,1
329	17,4
330	12,9
331	7,6
332	2,3
333	0,0
334	0,0

▼ M5

t	v
335	0,0
336	0,0
337	0,0
338	0,0
339	0,0
340	0,0
341	0,0
342	0,0
343	0,0
344	0,0
345	0,0
346	0,0
347	1,6
348	6,9
349	12,2
350	17,5
351	22,9
352	27,8
353	32,2
354	36,2
355	38,1
356	40,6
357	42,8
358	45,2
359	46,3
360	49,0
361	50,9
362	51,7
363	52,3
364	54,1
365	55,5
366	55,7
367	56,2
368	56,0
369	55,5
370	55,8
371	57,1
372	57,9
373	57,9
374	57,9
375	57,9
376	57,9
377	57,9
378	58,1
379	58,6
380	58,7
381	58,6
382	57,9
383	56,5
384	54,9
385	53,9
386	50,5
387	46,7
388	41,4
389	37,0
390	32,7
391	28,2
392	23,3
393	19,3
394	14,0
395	8,7
396	3,4
397	0,0
398	0,0
399	0,0
400	0,0
401	0,0

▼M5

t	v
402	0,0
403	4,2
404	9,5
405	14,5
406	20,1
407	25,4
408	30,7
409	36,0
410	40,2
411	41,2
412	44,3
413	46,7
414	48,3
415	48,4
416	48,3
417	47,8
418	47,2
419	46,3
420	45,1
421	40,2
422	34,9
423	29,6
424	24,3
425	19,0
426	13,7
427	8,4
428	3,1
429	0,0
430	0,0
431	0,0
432	0,0
433	0,0
434	0,0
435	0,0
436	0,0
437	0,0
438	0,0
439	0,0
440	0,0
441	0,0
442	0,0
443	0,0
444	0,0
445	0,0
446	0,0
447	0,0
448	5,3
449	10,6
450	15,9
451	21,2
452	26,6
453	31,0
454	37,2
455	42,5
456	44,7
457	46,8
458	50,7
459	53,1
460	54,1
461	56,0
462	56,5
463	57,3
464	58,1
465	57,9
466	58,1
467	58,3
468	57,9

▼M5

t	v
469	57,5
470	57,9
471	57,9
472	57,3
473	57,1
474	57,0
475	56,6
476	56,6
477	56,6
478	56,6
479	56,6
480	56,6
481	56,3
482	56,5
483	56,6
484	57,1
485	56,6
486	56,3
487	56,3
488	56,3
489	56,0
490	55,7
491	55,8
492	53,9
493	51,5
494	46,4
495	45,1
496	41,0
497	36,2
498	31,9
499	26,6
500	21,2
501	16,6
502	11,6
503	6,4
504	1,6
505	0,0
506	0,0
507	0,0
508	0,0
509	0,0
510	0,0
511	1,9
512	5,6
513	8,9
514	10,5
515	13,7
516	15,4
517	16,9
518	19,2
519	22,5
520	25,7
521	28,5
522	30,6
523	32,3
524	33,6
525	35,4
526	37,0
527	38,3
528	39,4
529	40,1
530	40,2
531	40,2
532	40,2
533	40,2
534	40,2
535	40,2

▼ M5

t	v
536	41,2
537	41,5
538	41,8
539	41,2
540	40,6
541	40,2
542	40,2
543	40,2
544	39,3
545	37,2
546	31,9
547	26,6
548	21,2
549	15,9
550	10,6
551	5,3
552	0,0
553	0,0
554	0,0
555	0,0
556	0,0
557	0,0
558	0,0
559	0,0
560	0,0
561	0,0
562	0,0
563	0,0
564	0,0
565	0,0
566	0,0
567	0,0
568	0,0
569	5,3
570	10,6
571	15,9
572	20,9
573	23,5
574	25,7
575	27,4
576	27,4
577	21,4
578	28,2
579	28,5
580	28,5
581	28,2
582	27,4
583	27,2
584	26,7
585	27,4
586	27,5
587	27,4
588	26,7
589	26,6
590	26,6
591	26,7
592	27,4
593	28,3
594	29,8
595	30,9
596	32,5
597	33,8
598	34,0
599	34,1
600	34,8
601	35,4
602	36,0

▼ M5

t	v
603	36,2
604	36,2
605	36,2
606	36,5
607	38,1
608	40,4
609	41,8
610	42,6
611	43,5
612	42,0
613	36,7
614	31,4
615	26,1
616	20,8
617	15,4
618	10,1
619	4,8
620	0,0
621	0,0
622	0,0
623	0,0
624	0,0
625	0,0
626	0,0
627	0,0
628	0,0
629	0,0
630	0,0
631	0,0
632	0,0
633	0,0
634	0,0
635	0,0
636	0,0
637	0,0
638	0,0
639	0,0
640	0,0
641	0,0
642	0,0
643	0,0
644	0,0
645	0,0
646	3,2
647	7,2
648	12,6
649	16,4
650	20,1
651	22,5
652	24,6
653	28,2
654	31,5
655	33,8
656	35,7
657	37,5
658	39,4
659	40,7
660	41,2
661	41,8
662	43,9
663	43,1
664	42,3
665	42,5
666	42,6
667	42,6
668	41,8
669	41,0

▼ M5

t	v
670	38,0
671	34,4
672	29,8
673	26,4
674	23,3
675	18,7
676	14,0
677	9,3
678	5,6
679	3,2
680	0,0
681	0,0
682	0,0
683	0,0
684	0,0
685	0,0
686	0,0
687	0,0
688	0,0
689	0,0
690	0,0
691	0,0
692	0,0
693	0,0
694	2,3
695	5,3
696	7,1
697	10,5
698	14,8
699	18,2
700	21,7
701	23,5
702	26,4
703	26,9
704	26,6
705	26,6
706	29,3
707	30,9
708	32,3
709	34,6
710	36,2
711	36,2
712	35,6
713	36,5
714	37,5
715	37,8
716	36,2
717	34,8
718	33,0
719	29,0
720	24,1
721	19,3
722	14,5
723	10,0
724	7,2
725	4,8
726	3,4
727	0,8
728	0,8
729	5,1
730	10,5
731	15,4
732	20,1
733	22,5
734	25,7
735	29,0
736	31,5

▼ M5

t	v
737	34,6
738	37,2
739	39,4
740	41,0
741	42,6
742	43,6
743	44,4
744	44,9
745	45,5
746	46,0
747	46,0
748	45,5
749	45,4
750	45,1
751	44,3
752	43,1
753	41,0
754	37,8
755	34,6
756	30,6
757	26,6
758	24,0
759	20,1
760	15,1
761	10,0
762	4,8
763	2,4
764	2,4
765	0,8
766	0,0
767	4,8
768	10,1
769	15,4
770	20,8
771	25,4
772	28,2
773	29,6
774	31,4
775	33,3
776	35,4
777	37,3
778	40,2
779	42,6
780	44,3
781	45,1
782	45,5
783	46,5
784	46,5
785	46,5
786	46,3
787	45,9
788	45,5
789	45,5
790	45,5
791	45,4
792	44,4
793	44,3
794	44,3
795	44,3
796	44,3
797	44,3
798	44,3
799	44,4
800	45,1
801	45,9
802	48,3
803	49,9

▼ M5

t	v
804	51,5
805	53,1
806	53,1
807	54,1
808	54,7
809	55,2
810	55,0
811	54,7
812	54,7
813	54,6
814	54,1
815	53,3
816	53,1
817	52,3
818	51,5
819	51,3
820	50,9
821	50,7
822	49,2
823	48,3
824	48,1
825	48,1
826	48,1
827	48,1
828	47,6
829	47,5
830	47,5
831	47,2
832	46,5
833	45,4
834	44,6
835	43,5
836	41,0
837	38,1
838	35,4
839	33,0
840	30,9
841	30,9
842	32,3
843	33,6
844	34,4
845	35,4
846	36,4
847	37,3
848	38,6
849	40,2
850	41,8
851	42,8
852	42,8
853	43,1
854	43,5
855	43,8
856	44,7
857	45,2
858	46,3
859	46,5
860	46,7
861	46,8
862	46,7
863	45,2
864	44,3
865	43,5
866	41,5
867	40,2
868	39,4
869	39,9
870	40,4

▼M5

t	v
871	41,0
872	41,4
873	42,2
874	43,3
875	44,3
876	44,7
877	45,7
878	46,7
879	47,0
880	46,8
881	46,7
882	46,5
883	45,9
884	45,2
885	45,1
886	45,1
887	44,4
888	43,8
889	42,8
890	43,5
891	44,3
892	44,7
893	45,1
894	44,7
895	45,1
896	45,1
897	45,1
898	44,6
899	44,1
900	43,3
901	42,8
902	42,6
903	42,6
904	42,6
905	42,3
906	42,2
907	42,2
908	41,7
909	41,2
910	41,2
911	41,7
912	41,5
913	41,0
914	39,6
915	37,8
916	35,7
917	34,8
918	34,8
919	34,9
920	36,4
921	37,7
922	38,6
923	38,9
924	39,3
925	40,1
926	40,4
927	40,6
928	40,7
929	41,0
930	40,6
931	40,2
932	40,3
933	40,2
934	39,8
935	39,4
936	39,1
937	39,1

▼ M5

t	v
938	39,4
939	40,2
940	40,2
941	39,6
942	39,6
943	38,8
944	39,4
945	40,4
946	41,2
947	40,4
948	38,6
949	35,4
950	32,3
951	27,2
952	21,9
953	16,6
954	11,3
955	6,0
956	0,6
957	0,0
958	0,0
959	0,0
960	3,2
961	8,5
962	13,8
963	19,2
964	24,5
965	28,2
966	29,9
967	32,2
968	34,0
969	35,4
970	37,0
971	39,4
972	42,3
973	44,3
974	45,2
975	45,7
976	45,9
977	45,9
978	45,9
979	44,6
980	44,3
981	43,8
982	43,1
983	42,6
984	41,8
985	41,4
986	40,6
987	38,6
988	35,4
989	34,6
990	34,6
991	35,1
992	36,2
993	37,0
994	36,7
995	36,7
996	37,0
997	36,5
998	36,5
999	36,5
1 000	37,8
1 001	38,6
1 002	39,6
1 003	39,9
1 004	40,4

▼ M5

t	v
1 005	41,0
1 006	41,2
1 007	41,0
1 008	40,2
1 009	38,8
1 010	38,1
1 011	37,3
1 012	36,9
1 013	36,2
1 014	35,4
1 015	34,8
1 016	33,0
1 017	28,2
1 018	22,9
1 019	17,5
1 020	12,2
1 021	6,9
1 022	1,6
1 023	0,0
1 024	0,0
1 025	0,0
1 026	0,0
1 027	0,0
1 028	0,0
1 029	0,0
1 030	0,0
1 031	0,0
1 032	0,0
1 033	0,0
1 034	0,0
1 035	0,0
1 036	0,0
1 037	0,0
1 038	0,0
1 039	0,0
1 040	0,0
1 041	0,0
1 042	0,0
1 043	0,0
1 044	0,0
1 045	0,0
1 046	0,0
1 047	0,0
1 048	0,0
1 049	0,0
1 050	0,0
1 051	0,0
1 052	0,0
1 053	1,9
1 054	6,4
1 055	11,7
1 056	17,1
1 057	22,4
1 058	27,4
1 059	29,8
1 060	32,2
1 061	35,1
1 062	37,0
1 063	38,6
1 064	39,9
1 065	41,2
1 066	42,6
1 067	43,1
1 068	44,1
1 069	44,9
1 070	45,5
1 071	45,1

▼M5

t	v
1 072	44,3
1 073	43,5
1 074	43,5
1 075	42,3
1 076	39,4
1 077	36,2
1 078	34,6
1 079	33,2
1 080	29,0
1 081	24,1
1 082	19,8
1 083	17,9
1 084	17,1
1 085	16,1
1 086	15,3
1 087	14,6
1 088	14,0
1 089	13,8
1 090	14,2
1 091	14,5
1 092	14,0
1 093	13,8
1 094	12,9
1 095	11,3
1 096	8,0
1 097	6,8
1 098	4,2
1 099	1,6
1 100	0,0
1 101	0,2
1 102	1,0
1 103	2,6
1 104	5,8
1 105	11,1
1 106	16,1
1 107	20,6
1 108	22,5
1 109	23,3
1 110	25,7
1 111	29,1
1 112	32,2
1 113	33,8
1 114	34,1
1 115	34,3
1 116	34,4
1 117	34,9
1 118	36,2
1 119	37,0
1 120	38,3
1 121	39,4
1 122	40,2
1 123	40,1
1 124	39,9
1 125	40,2
1 126	40,9
1 127	41,5
1 128	41,8
1 129	42,5
1 130	42,8
1 131	43,3
1 132	43,5
1 133	43,5
1 134	43,5
1 135	43,3
1 136	43,1
1 137	43,1
1 138	42,6

▼M5

t	v
1 139	42,5
1 140	41,8
1 141	41,0
1 142	39,6
1 143	37,8
1 144	34,6
1 145	32,2
1 146	28,2
1 147	25,7
1 148	22,5
1 149	17,2
1 150	11,9
1 151	6,6
1 152	1,3
1 153	0,0
1 154	0,0
1 155	0,0
1 156	0,0
1 157	0,0
1 158	0,0
1 159	0,0
1 160	0,0
1 161	0,0
1 162	0,0
1 163	0,0
1 164	0,0
1 165	0,0
1 166	0,0
1 167	0,0
1 168	0,0
1 169	3,4
1 170	8,7
1 171	14,0
1 172	19,3
1 173	24,6
1 174	29,9
1 175	34,0
1 176	37,0
1 177	37,8
1 178	37,0
1 179	36,2
1 180	32,2
1 181	26,9
1 182	21,6
1 183	16,3
1 184	10,9
1 185	5,6
1 186	0,3
1 187	0,0
1 188	0,0
1 189	0,0
1 190	0,0
1 191	0,0
1 192	0,0
1 193	0,0
1 194	0,0
1 195	0,0
1 196	0,0
1 197	0,3
1 198	2,4
1 199	5,6
1 200	10,5
1 201	15,8
1 202	19,3
1 203	20,8
1 204	20,9
1 205	20,3

▼M5

t	v
1 206	20,6
1 207	21,1
1 208	21,1
1 209	22,5
1 210	24,9
1 211	27,4
1 212	29,9
1 213	31,7
1 214	33,8
1 215	34,6
1 216	35,1
1 217	35,1
1 218	34,6
1 219	34,1
1 220	34,6
1 221	35,1
1 222	35,4
1 223	35,2
1 224	34,9
1 225	34,6
1 226	34,6
1 227	34,4
1 228	32,3
1 229	31,4
1 230	30,9
1 231	31,5
1 232	31,9
1 233	32,2
1 234	31,4
1 235	28,2
1 236	24,9
1 237	20,9
1 238	16,1
1 239	12,9
1 240	9,7
1 241	6,4
1 242	4,0
1 243	1,1
1 244	0,0
1 245	0,0
1 246	0,0
1 247	0,0
1 248	0,0
1 249	0,0
1 250	0,0
1 251	0,0
1 252	1,6
1 253	1,6
1 254	1,6
1 255	1,6
1 256	1,6
1 257	2,6
1 258	4,8
1 259	6,4
1 260	8,0
1 261	10,1
1 262	12,9
1 263	16,1
1 264	16,9
1 265	15,3
1 266	13,7
1 267	12,2
1 268	14,2
1 269	17,7
1 270	22,5
1 271	27,4
1 272	31,4

▼M5

t	v
1 273	33,8
1 274	35,1
1 275	35,7
1 276	37,0
1 277	38,0
1 278	38,8
1 279	39,4
1 280	39,4
1 281	38,6
1 282	37,8
1 283	37,8
1 284	37,8
1 285	37,8
1 286	37,8
1 287	37,8
1 288	38,6
1 289	38,8
1 290	39,4
1 291	39,8
1 292	40,2
1 293	40,9
1 294	41,2
1 295	41,4
1 296	41,8
1 297	42,2
1 298	43,5
1 299	44,7
1 300	45,5
1 301	46,7
1 302	46,8
1 303	46,7
1 304	45,1
1 305	39,8
1 306	34,4
1 307	29,1
1 308	23,8
1 309	18,5
1 310	13,2
1 311	7,9
1 312	2,6
1 313	0,0
1 314	0,0
1 315	0,0
1 316	0,0
1 317	0,0
1 318	0,0
1 319	0,0
1 320	0,0
1 321	0,0
1 322	0,0
1 323	0,0
1 324	0,0
1 325	0,0
1 326	0,0
1 327	0,0
1 328	0,0
1 329	0,0
1 330	0,0
1 331	0,0
1 332	0,0
1 333	0,0
1 334	0,0
1 335	0,0
1 336	0,0
1 337	0,0
1 338	2,4
1 339	7,7

▼ M5

t	v
1 340	13,0
1 341	18,3
1 342	21,2
1 343	24,3
1 344	27,0
1 345	29,5
1 346	31,4
1 347	32,7
1 348	34,3
1 349	35,2
1 350	35,6
1 351	36,0
1 352	35,4
1 353	34,8
1 354	34,0
1 355	33,0
1 356	32,2
1 357	31,5
1 358	29,8
1 359	28,2
1 360	26,6
1 361	24,9
1 362	22,5
1 363	17,7
1 364	12,9
1 365	6,4
1 366	4,0
1 367	0,0
1 368	0,0
1 369	0,0
1 370	0,0
1 371	0,0

▼ M5

Appendix 2

CHASSIS DYNAMOMETER

1. DEFINITION
 - 1.1. *Idem* section 1.1 of Appendix 2 to Annex III, but replace '50 km/h' by '80,5 km/h'.
2. METHOD OF CALIBRATING THE DYNAMOMETER
 - 2.1. *Idem* section 2.1 of Appendix 2 to Annex III.
 - 2.2. Calibrating the power indicator to 80,5 km/h.
 - 2.2.1. The dynamometer must be calibrated at least once each month or performance verified at least once each week with a view to calibration if required. Calibration must be carried out at 80,5 km/h in accordance with the procedure described below. The measured absorbed power comprises the power absorbed by frictional effects and the power absorbed by the power absorption device. The dynamometer is driven above the test speed range. The device used for starting up the dynamometer is then disengaged from the dynamometer and the roller(s) is (are) allowed to coast down. The kinetic energy of the roller is dissipated by the power absorption device and frictional effects. This method disregards variations in the internal friction of the rollers when carrying a load or running free. The frictional effects of the rear roll shall be disregarded when this is free.
 - 2.2.1.1. Measure the rotational speed of the drive roller if this has not already been done. A fifth wheel, a revolution counter or other suitable means may be used.
 - 2.2.1.2. Place a vehicle on the dynamometer or use another method of starting up the dynamometer.
 - 2.2.1.3. Engage the flywheel or other system of inertia simulation for the most common vehicle mass category for which the dynamometer is used. In addition other vehicle mass categories may be calibrated, if desired.
 - 2.2.1.4. Drive the dynamometer up to 80,5 km/h.
 - 2.2.1.5. Record indicated road power.
 - 2.2.1.6. Drive the dynamometer up to 96,9 km/h.
 - 2.2.1.7. Disengage the device used to drive the dynamometer.
 - 2.2.1.8. Record the time for the dynamometer drive roller to coast down from 88,5 km/h to 72,4 km/h.
 - 2.2.1.9. Adjust the power absorption device to a different level.
 - 2.2.1.10. Repeat 2.2.1.1 to 2.2.1.9 above a sufficient number of times to cover the range of absorbed power used.
 - 2.2.1.11. Calculate the power absorbed. See section 2.2.3.
 - 2.2.1.12. Plot power indicated at 80,5 km/h versus absorbed power (as shown in figure A).
 - 2.2.2. The performance check consists of conducting a dynamometer coastdown at one or more inertia +horsepower settings and comparing the coastdown time to that recorded during the last calibration. If the coastdown times differ by more than 1_s a new calibration is required.
 - 2.2.3. *Calculations*

The power actually absorbed by the dynamometer is calculated from the following equation:

$$Pa = W \frac{V_1^2 - V_2^2}{2000 t}$$

where:

Pa = power (kW)

W = equivalent inertia (kg)

▼ **M5**

V_1 = initial velocity (m/s)

V_2 = final velocity (m/s)

t = elapsed time for rollers to coast from 88,5 to 72,4 km/h.

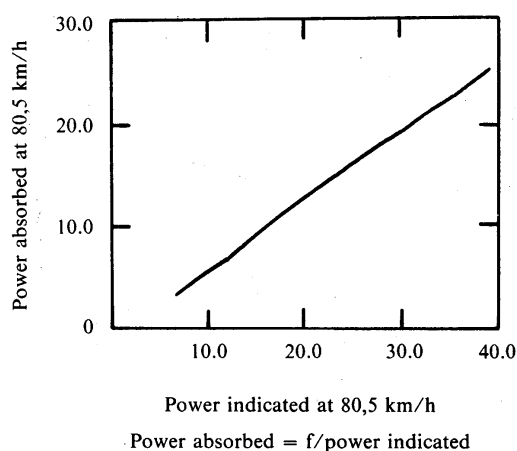

Figure A

2.3. *Idem* section 2.3 of Appendix 2 to Annex III.

2.4. Deleted.

3. SETTING OF THE DYNAMOMETER

3.1. Vacuum method

Idem section 3.1 of Appendix 2 to Annex III, but replace 'at the speed of 50 km/h' by 'at the speed of 80,5 km/h'.

3.2. Other setting method

Idem section 3.2 of Appendix 2 to Annex III, but replace 'at the speed of 50 km/h' by 'at the speed of 80,5 km/h'.

3.3. Alternative method

3.3.1. The power absorption device is adjusted to reproduce power absorbed at 80,5 km/h true speed. The dynamometer power absorption must take into account the dynamometer friction.

The following method has been established for small twin +roll dynamometers having a nominal roll diameter of 220 mm and a nominal roll spacing of 432 mm and large single +roll dynamometers having a nominal roll +diameter of 1 219 mm. Dynamometers with other roll specifications may be used if approved by the technical service.

3.3.2. The dynamometer road load setting is determined from the equivalent test mass, the reference frontal area, the body shape, the vehicle protuberances and the tyre type according to the following equations.

3.3.2.1. For light +duty vehicles to be tested on a twin +roller dynamometer:

$$P_A = aA + P + tw$$

where:

P_A = setting at 80,5 km/h (kW)

A = the vehicle reference frontal area (m²). The vehicle reference frontal area is defined as the area of the orthogonal projection of the vehicle including tyres and suspension components, but excluding vehicle protuberances, on to a plane perpendicular to both the longitudinal plane of the

▼ M5

vehicle and the surface upon which the vehicle is positioned. Measurements of this area are computed to the nearest hundredth of a square metre using a method approved in advance by the technical service responsible for the tests

P = the protuberance power correction factor from table 1 of this section

w = vehicle equivalent test mass (kg)

a = 3,45 for fastback +shaped vehicles; = 4,01 for all other light +duty vehicles

t = 0,0 for vehicles equipped with radial +ply tyres; = $4,93 \times 10^{-4}$ for all other vehicles

A vehicle is considered to have a fastback shape if the rearward projection of that portion of the rear surface (A_2) which slopes at an angle of less than 20° from the horizontal is at least 25 % as large as the vehicle reference frontal area. In addition, this surface must be smooth, continuous, and free from any local transitions greater than 4° . An example of a fastback shape is presented in Figure 1.

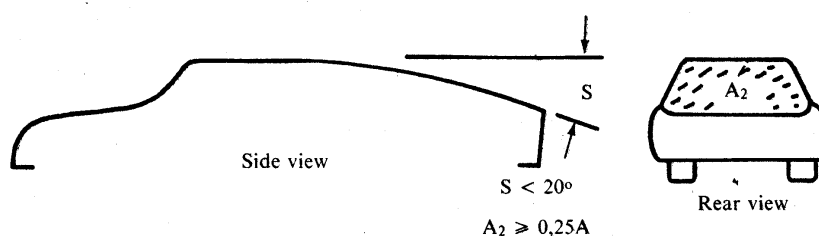

Figure 1

TABLE 1

Protuberance power (P) versus total protuberance frontal area (A_p)

A_p (m ²)	P
$A_p < 0,03$	0,0
$0,03 \leq A_p < 0,06$	0,30
$0,06 \leq A_p < 0,08$	0,52
$0,08 \leq A_p < 0,11$	0,75
$0,11 \leq A_p < 0,14$	0,97
$0,14 \leq A_p < 0,17$	1,19
$0,17 \leq A_p < 0,19$	1,42
$0,19 \leq A_p < 0,22$	1,64
$0,22 \leq A_p < 0,25$	1,87
$0,25 \leq A_p < 0,28$	2,09
$0,28 \leq A_p$	2,31

The protuberance frontal area, A_p , is defined in a manner analogous to the definition of the vehicle reference frontal area, i.e. the total area of the orthogonal projections of the vehicle mirrors, handles, roof racks, and other protuberances on to a plane perpendicular to both the longitudinal plane of the vehicle and the surface upon which the vehicle is positioned. A protuberance is defined as any fixture attached to the vehicle protruding more than 2,54 cm from the vehicle surface and having a projected area greater than 0,00093 m² with the area calculated by a method approved in advance by the technical service responsible for the tests. Included in the total protuberance frontal area are all fixtures which occur as standard equipment. The area of any optional equipment is also included if it is expected that more than 33 % of the vehicle range sold will be equipped with this option.

▼M5

- 3.3.2.2. The dynamometer power absorber setting for light +duty vehicles is rounded off to the nearest 0,1 kW.
- 3.3.2.3. The equation to be used for testing light +duty vehicles on a single large +roller dynamometer is as follows:

$$P_A = aA + P + (8,22 \times 10^{-4} + 0,33 t)w$$

All symbols in the above equation are defined in section 3.3.2.1.

▼ M5

Appendix 3

RESISTANCE TO PROGRESS OF A VEHICLE —
MEASUREMENT METHOD ON THE ROAD AND ON A CHASSIS
DYNAMOMETER

(Idem Appendix 3 to Annex III)

▼ M5

Appendix 4

VERIFICATION OF INERTIAS OTHER THAN MECHANICAL

(Idem Appendix 4 of Annex III)

▼ M5

Appendix 5

DEFINITION OF GAS SAMPLING SYSTEMS

(*Idem* Appendix 5 of Annex III, but six bags (instead of two) are necessary on the CVS)

▼ M5

Appendix 6

METHOD OF CALIBRATING THE EQUIPMENT

(Idem Appendix 6 to Annex III)

▼ M5

Appendix 7

TOTAL SYSTEM VERIFICATION

(Idem Appendix 7 to Annex III)

▼ **M5***Appendix 8*

CALCULATION OF THE MASS EMISSIONS OF POLLUTANTS

The mass emissions of pollutants are calculated by the following equation:

$$M_i = 0,43 \frac{M_{icT} M_{is}}{S_{cT} + S_s} + 0,57 \frac{M_{iHT} + M_{is}}{S_{HT} + S_s}$$

where:

- M_i = mass emission of the pollutant, i, in grams per kilometre
- M_{icT} = mass emission of the pollutant, i, in grams, during the first phase (transient cold)
- M_{iHT} = mass emission of the pollutant, i, in grams, during the last phase (transient hot)
- M_{is} = mass emission of the pollutant, i, in grams, during the second phase (stabilized)
- S_{cT} = distance (in km) which has been run during the first phase
- S_{HT} = distance (in km) which has been run during the last phase
- S_s = distance (in km) which has been run during the second phase

The mass emissions of pollutants are calculated by means of the following:

$$M_i = V_{mix} \times Q_i \times k_H \times C_i \times 10^{-6}$$

where:

- M_i = mass emission of the pollutant, i, in grams, per phase
- V_{mix} = volume of the diluted exhaust gas, expressed in litres, per phase and corrected to standard conditions (273,2 K and 101,33 kPa)
- Q_i = density of the pollutant, i, in grams per litre, at normal temperature and pressure (273,2 K and 101,33 kPa)
- k_H = humidity correction factor used for the calculation of the mass emissions of oxides of nitrogen. There is no humidity correction for HC and CO
- C_i = concentration of the pollutant, i, in the diluted exhaust gas expressed in parts per million and corrected by the amount of the pollutant, i, contained in the dilution air

▼ **M4***ANNEX IV***TYPE II TEST****(Carbon monoxide emission test at idling speed)**

1. INTRODUCTION

This Annex describes the procedure for the type II test defined in 5.2.1.2 of Annex I.

2. CONDITIONS OF MEASUREMENT

- 2.1. The fuel must be the reference fuel, specifications for which are given in Annex VI.
- 2.2. The type II test must be carried out immediately after the fourth operating cycle of the type I test, with the engine at idling speed, the cold-start device not being used. Immediately before each measurement of the carbon-monoxide content, a type I test operating cycle as described in Annex 2.1 of Annex III must be carried out.
- 2.3. In the case of vehicles with manually-operated or semi-automatic-shift gearboxes the test must be carried out with the gear lever in the 'neutral' position and with the clutch engaged.
- 2.4. In the case of vehicles with automatic-shift gear-boxes the test is carried out with the gear selector in either the 'neutral' or the 'parking' position.

2.5. **Components for adjusting the idling speed**2.5.1. *Definition*

For the purposes of this Directive, 'components for adjusting the idling speed' means controls for changing the idling conditions of the engine which may be easily operated by a mechanic using only the tools described in 2.5.1.1. In particular, devices for calibrating fuel and air flows are not considered as adjustment components if their setting requires the removal of the set-stops, an operation which cannot normally be performed except by a professional mechanic.

- 2.5.1.1. Tools which may be used to control components for adjusting the idling speed: screwdrivers (ordinary or cross-headed), spanners (ring, open-end or adjustable), pliers, Allen keys.

2.5.2. *Determination of measurement points*

- 2.5.2.1. A measurement at the setting used for the type I test is performed first.
- 2.5.2.2. For each adjustment component with a continuous variation, a sufficient number of characteristic positions are determined.
- 2.5.2.3. The measurement of the carbon-monoxide content of exhaust gases must be carried out for all the possible positions of the adjustment components, but for components with a continuous variation only the positions defined in 2.5.2.2 are adopted.
- 2.5.2.4. The type II test is considered satisfactory if at least one of the two following conditions is met:
- 2.5.2.4.1. none of the values measured in accordance with 2.5.2.3 exceeds the limit values;
- 2.5.2.4.2. the maximum content obtained by continuously varying one of the adjustment components while the other components are kept stable does not exceed the limit value, this condition being met for the various combinations of adjustment components other than the one which was varied continuously.
- 2.5.2.5. The possible positions of the adjustment components are limited:
- 2.5.2.5.1. on the one hand, by the larger of the following two values: the lowest idling speed which the engine can reach; the speed recommended by the manufacturer, minus 100 revolutions per minute;
- 2.5.2.5.2. on the other hand, by the smallest of the following three values: the highest speed the engine can attain by activation of the idling speed

▼ M4

components; the speed recommended by the manufacturer, plus 250 revolutions per minute; the cut-in speed of automatic clutches.

- 2.5.2.6. In addition, settings incompatible with correct running of the engine must not be adopted as measurement settings. In particular, when the engine is equipped with several carburettors all the carburettors must have the same setting.

3. SAMPLING OF GASES

- 3.1. The sampling probe is placed in the pipe connecting the exhaust with the sampling bag and as close as possible to the exhaust.
- 3.2. The concentration in CO (C_{CO}) and CO₂ (C_{CO_2}) is determined from the measuring instrument readings or recordings, by use of appropriate calibration curves.
- 3.3. The corrected concentration for carbon monoxide regarding four-stroke engines is:

$$C_{CO \text{ corr}} = C_{CO} \frac{15}{C_{CO} + C_{CO_2}} (\% \text{ vol})$$

- 3.4. The concentration in C_{CO} (see 3.2) measured according to the formulae contained in 3.3 need not be corrected if the total of the concentrations measured ($C_{CO} + C_{CO_2}$) is at least 15 for four-stroke engines.

▼ **M4***ANNEX V***TYPE III TEST****(Verifying emissions of crankcase gases)**

1. INTRODUCTION

This Annex describes the procedure for the type III test defined in 5.2.1.3 of Annex I.

2. GENERAL PROVISIONS

- 2.1. Test III is carried out on the vehicle with gasoline-fuelled engine subjected to the type I and the type II test.
- 2.2. The engines tested must include leak-proof engines other than those so designed that even a slight leak may cause unacceptable operating faults (such as flat-twin engines).

3. TEST CONDITIONS

- 3.1. Idling must be regulated in conformity with the manufacturer's recommendations.
- 3.2. The measurements are performed in the following three sets of conditions of engine operation:

Condition No	Vehicle speed (km/h)
1	Idling
2	50 ± 2
3	50 ± 2

Condition No	Power absorbed by brake
1	Nil
2	That corresponding to the settings for type I tests
3	That for conditions No 2, multiplied by a factor of 1,7

4. TEST METHOD

- 4.1. For the operation conditions as listed in 3.2 reliable function of the crankcase ventilation system must be checked.

5. METHOD OF VERIFICATION OF THE CRANKCASE VENTILATION SYSTEM

- 5.1. The engine's apertures must be left as found.
- 5.2. The pressure in the crankcase is measured at an appropriate location. It is measured at the dipstick hole with an inclined-tube manometer.
- 5.3. The vehicle is deemed satisfactory if, in every condition of measurement defined in 3.2, the pressure measured in the crankcase does not exceed the atmospheric pressure prevailing at the time of measurement.
- 5.4. For the test by the method described above, the pressure in the intake manifold is measured to within ± 1 kPa.
- 5.5. The vehicle speed as indicated at the dynamometer is measured to within ± 2 km/h.
- 5.6. The pressure measured in the crankcase is measured to within ± 0,01 kPa.
- 5.7. If in one of the conditions of measurement defined in 3.2 the pressure measured in the crankcase exceeds the atmospheric pressure, an additional test as defined in 6 is performed if so requested by the manufacturer.

6. ADDITIONAL TEST METHOD

- 6.1. The engine's apertures must be left as found.

▼ M4

- 6.2. A flexible bag impervious to crankcase gases and having a capacity of approximately five litres is connected to the dipstick hole. The bag must be empty before each measurement.
- 6.3. The bag must be closed before each measurement. It must be opened to the crankcase for five minutes for each condition of measurement prescribed in 3.2.
- 6.4. The vehicle is deemed satisfactory if in every condition of measurement defined in 3.2 no visible inflation of the bag occurs.
- 6.5. **Remark**
 - 6.5.1. If the structural layout of the engine is such that the test cannot be performed by the methods described in 6 above, the measurements must be effected by that method modified as follows:
 - 6.5.2. before the test, all apertures other than that required for the recovery of the gases are closed;
 - 6.5.3. the bag is placed on a suitable take-off which does not introduce any additional loss of pressure and is installed on the recycling circuit of the device directly at the engine-connection aperture.

▼M4

TYPE III TEST

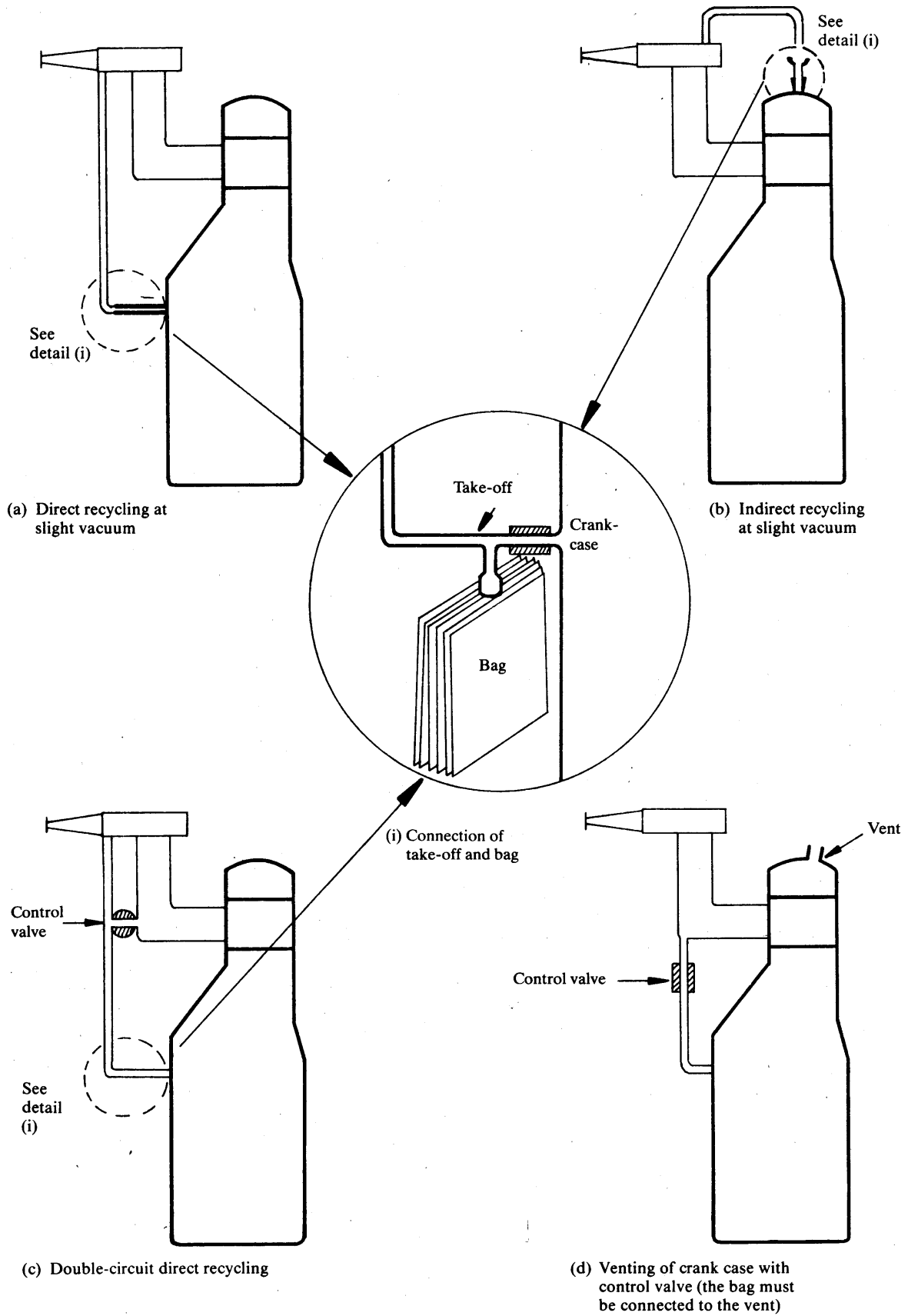

▼ **M4**

ANNEX VI

SPECIFICATIONS OF REFERENCE FUELS

▼ **M5**

1. TECHNICAL DATA OF THE REFERENCE FUEL TO BE USED FOR TESTING VEHICLES EQUIPPED WITH POSITIVE-IGNITION ENGINES

CEC reference fuel RF-08-A-85

Type: Premium petrol, unleaded

	Limits and units		ASTM method
	minimum	maximum	
Research octane number	95,0		D 2699
Motor octane number	85,0		D 2 700
Density at 15 °C	0,748	0,762	D 1 298
Reid vapour pressure	0,56 bar	0,64 bar	D 323
Distillation:			
— initial boiling point	24 °C	40 °C	D 86
— 10 % vol point	42 °C	58 °C	D 86
— 50 % vol point	90 °C	110 °C	D 86
— 90 % vol point	155 °C	180 °C	D 86
— final boiling point	190 °C	215 °C	D 86
Residue		2 %	D 86
Hydrocarbon analysis:			
— olefins		20 % vol	D 1319
— aromatics	(Including max. 5 % vol benzene (¹))	45 % vol	D 1319
— saturates		balance	(¹)D 3606/D 2267
Carbon/hydrogen ratio		ratio	D 1319
Oxidation stability	480 min.		D 525
Existent gum		4 mg/100 ml	D 381
Sulphur content		0,04 % mass	D 1266/D 2622/D 2785
Copper corrosion at 50 °C		1	D 130
Lead content		0,005 g/l	D 3237
Phosphorus content		0,0013 g/l	D 3231

(¹) Addition of oxygenates prohibited.

2. TECHNICAL DATA OF THE REFERENCE FUEL TO BE USED FOR TESTING VEHICLES EQUIPPED WITH A DIESEL ENGINE

CEC reference fuel RF-03-A-84 (¹) (²) (³)

Type: Diesel fuel

	Limits and units	ASTM Method
Cetane number (⁴)	min. 49 max. 53	D 613
Density 15 °C (kg/l)	min. 0,835 max. 0,845	D 1 298
Distillation (²):		
— 50 % point	min. 245 °C	D 86
— 90 % point	min. 320 °C max. 340 °C	
— final boiling point	max. 370 °C	
Flash point	min. 55 °C	D 93

▼M5

	Limits and units	ASTM Method
CFPP	min. — max. -5 °C	EN 116 (CEN)
Viscosity 40 °C	min. 2,5 mm ² /s max. 3,5 mm ² /s	D 445
Sulphur content	min. (to be reported) max. 0,3 % mass	D 1266/D 2622 D 2785
Copper corrosion	max. 1	D 130
Conradson carbon residue (10 % DR)	max. 0,2 % mass	D 189
Ash content	max. 0,01 % mass	D 482
Water content	max. 0,05 % mass	D 95/D 1744
Neutralization (strong acid) number	max. 0,20 mg KOH/g	
Oxidation stability ⁽⁶⁾ Additives ⁽⁵⁾	max. 2,5 mg/100 ml	D 2274

⁽¹⁾ Equivalent ISO methods will be adopted when issued for all properties listed above.

⁽²⁾ The figures quoted show the total evaporated quantities (% recovered + % loss).

⁽³⁾ The values quoted in the specification are 'true values'.

In establishment of their limit values the terms of ASTM D 3244, *Defining a Basis for Petroleum Product Quality Disputes*, have been applied and in fixing a maximum value, a minimum difference of 2R above zero has been taken into account; in fixing a maximum and minimum value, the minimum difference is 4R (R = reproducibility).

Notwithstanding this measure, which is necessary for statistical reasons, the manufacturer of a fuel should nevertheless aim at a zero value where the stipulated maximum value is 2R and at the mean value in the case of quotations of maximum and minimum limits.

Should it be necessary to clarify the question as to whether a fuel meets the requirements of the specification, the terms of ASTM D 3244 should be applied.

⁽⁴⁾ The range for cetane is not in accordance with the requirement of a minimum range of 4R. However, in cases of dispute between fuel supplier and user, the terms in ASTM D 3244 can be used to resolve such disputes provided replicate measurements, of sufficient number to achieve the necessary precision, are made in preference to single determinations.

⁽⁵⁾ This fuel should be based on straight run and cracked hydrocarbon distillate components only; desulphurization is allowed. It must not contain any metallic additives or cetane improver additives.

⁽⁶⁾ Even though oxidation stability is controlled it is likely that shelf life will be limited. Advice should be sought from the supplier as to storage conditions and life.

⁽⁷⁾ If it is required to calculate the thermal efficiency of an engine or vehicle, the calorific value of the fuel can be calculated from:

$$\text{Specific energy (calorific value) (net) in MJ/kg} = (46,423 - 8,792d^2 + 3,170d) (1 - (x + y + s)) + 9,420s - 2,499x$$

where:

d = the density at 15 °C

x = the proportion by mass of water (% divided by 100)

y = the proportion by mass of ash (% divided by 100)

s = the proportion by mass of sulphur (% divided by 100).

▼M5

ANNEX VII

MODEL

Maximum size: A 4 (210 × 297 mm)

Name of administration

ANNEX TO THE EEC VEHICLE TYPE-APPROVAL CERTIFICATE WITH REGARD TO THE EMISSION OF GASEOUS POLLUTANTS FROM THE ENGINE

(Articles 4 (2) and 10 of Council Directive 70/156/EEC of 6 February 1970 on the approximation of the laws of the Member States relating to the type-approval of motor vehicles and their trailers)

In the light of the amendments made pursuant to Directive 83/351/EEC

- EEC type-approval No :
1. Category of the vehicle type (M₁, N₁, etc.) :
 2. Trademark or trade name of the vehicle :
 3. Vehicle type : Engine type :
 4. Manufacturer's name and address :
.....
 5. If applicable, name and address of the manufacturer's authorized representative :
.....
 6. Engine capacity (in cm³) :
 7. Mass of vehicle in running order :
 - 7.1. Reference mass of vehicle :
 8. Technically permissible maximum mass of vehicle :
 9. Gearbox :
 - 9.1. Manual or automatic ⁽¹⁾ ⁽²⁾ :
 - 9.2. Number of gear ratios :
 - 9.3. Transmission ratios ⁽¹⁾ : first gear N/V :
second gear N/V :
third gear N/V :
fourth gear N/V :
fifth gear N/V :
- Final drive ratio :
- Tyres : dimensions :
dynamic rolling circumference :
- Wheel drive : front, rear, 4 × 4 ⁽¹⁾

⁽¹⁾ Delete as inapplicable.⁽²⁾ In the case of vehicles equipped with automatic-shift gearboxes, give all pertinent technical data.

▼ **M5**

- 9.4. Check of performance referred to in section 3.1.6 of Annex III to this Directive :
-
10. Date vehicle submitted for approval :
11. Technical service responsible for type-approval tests :
-
12. Date of test report issued by that service :
13. Number of test report issued by that service :
14. EEC type-approval granted/refused ⁽¹⁾
15. Results of approval tests carried out in accordance with Annex III/Annex III A ⁽¹⁾ :
- Inertia equivalent mass : kg
- Absorbed power P_a : kW at 50 km/h
- Method of setting :
- 15.1 Test type I carried out in accordance with Annex III :
- CO : g/test HC : g/test NO_x : g/test
- 15.2 Test type I carried out in accordance with Annex III A :
- CO : g/km HC : g/km NO_x : g/km
- 15.3 Test type II :
- CO : % vol at : idle rev./min
- 15.4 Test type III :
-
16. Gas sampling system used :
- 16.1. PDP/CVS ⁽¹⁾
- 16.2. CFV/CVS ⁽¹⁾
- 16.3. CFO/CVS ⁽¹⁾
17. Place :
18. Date :
19. Signature :
20. The following documents, bearing the EEC type-approval number shown above are attached to this Annex :
- one copy of Annex II to this Directive, duly completed and with the drawings and diagrams referred to attached,
 - one photograph of the engine and its compartment,
 -

⁽¹⁾ Delete as inapplicable.