

---

STATUTORY INSTRUMENTS

---

**2013 No. 2870**

**CIVIL AVIATION**

**The Air Navigation (Overseas Territories) Order 2013**

*Made* - - - - *6th November 2013*  
*Laid before Parliament* *13th November 2013*  
*Coming into force* - - *1st January 2014*

At the Court at Buckingham Palace, the 6th day of November 2013

Present

The Queen's Most Excellent Majesty in Council

Her Majesty, in exercise of the powers conferred on Her by sections 8, 41, 57, 58, 59 and 61 of the Civil Aviation Act 1949(1), as extended to certain territories by the Civil Aviation Act 1949 (Overseas Territories) Order 1969(2), and section 61 of the Civil Aviation Act 1982(3), as extended to certain territories by the Civil Aviation Act 1982 (Overseas Territories) (No. 2) Order 2001(4), is pleased, by and with the advice of Her Privy Council, to order as follows.

**Citation and Commencement**

1. This Order may be cited as the Air Navigation (Overseas Territories) Order 2013 and comes into force on 1st January 2014.

**Revocation**

2. The Orders specified in Schedule 1 to this Order are revoked.

**Interpretation**

3.—(1) In this Order, unless the context otherwise requires—  
“the Act” means the Civil Aviation Act 1949;

---

(1) 1949 c. 67. Although these provisions of Civil Aviation Act 1949 were repealed by the Civil Aviation Act 1982, by virtue of section 17(2) of the Interpretation Act 1978 the powers in the Civil Aviation Act 1949 which were re-enacted in the Civil Aviation Act 1982 can continue to be relied upon for the purposes of making this Order.  
(2) S.I. 1969/592 as amended by S.I. 2001/1452 and S.I. 2011/2979. There are other amendments but none relevant to this Order.  
(3) 1982 c. 16. Section 61 has been amended by section 2 of the Aviation (Offences) Act 2003 (c. 19) and section 83(5) of, and part II of Schedule 6 to, the Airports Act 1986 (c. 31).  
(4) S.I. 2001/3367 as amended by S.I. 2011/2979. There are other amendments but none relevant to this Order.

“aerial work” has the meaning assigned to it by article 126;

“aerial work aircraft” means an aircraft (other than a commercial air transport aircraft) flying, or intended by the operator to fly, for the purpose of aerial work;

“aerial work undertaking” means an undertaking whose business includes the performance of aerial work;

“aerobatic manoeuvres” includes loops, spins, rolls, bunts, stall turns, inverted flying and any other similar manoeuvre;

“aerodrome” means any area of land or water designed, equipped, set apart or commonly used for affording facilities for the landing and departure of aircraft and includes any area or space, whether on the ground, on the roof of a building or elsewhere, which is designed, equipped or set apart for affording facilities for the landing and departure of aircraft capable of descending or climbing vertically, but shall not include any area the use of which for affording facilities for the landing and departure of aircraft has been abandoned and has not been resumed;

“aerodrome control service” means an air traffic control service for any aircraft on the manoeuvring area or apron of the aerodrome in respect of which the service is being provided or which is flying in, or in the vicinity of, the aerodrome traffic zone of that aerodrome by visual reference to the surface;

“aerodrome operating minima” in relation to the operation of an aircraft at an aerodrome means the cloud ceiling and runway visual range for take-off, and the decision height or minimum descent height, runway visual range and visual reference for landing, which are the minimum for the operation of that aircraft at that aerodrome;

“aerodrome traffic zone” means the airspace specified in sub-paragraphs (a) and (b), being airspace in the vicinity of an aerodrome which is notified for the purposes of rule 45 of the Rules of the Air—

- (a) in relation to such an aerodrome at which the length of the longest runway is notified as 1850 metres or less—
  - (i) subject to sub-paragraph (ii), the airspace extending from the surface to a height of 2000 ft above the level of the aerodrome within the area bounded by a circle centred on the notified mid-point of the longest runway and having a radius of 2 nautical miles;
  - (ii) where such an aerodrome traffic zone would extend less than 1½ nautical miles beyond the end of any runway at the aerodrome and this sub-paragraph is notified as being applicable, sub-paragraph (b) applies as though the length of the longest runway is notified as greater than 1850 metres;
- (b) in relation to such an aerodrome at which the length of the longest runway is notified as greater than 1850 metres, the airspace extending from the surface to a height of 2000 ft above the level of the aerodrome within the area bounded by a circle centred on the notified mid-point of the longest runway and having a radius of 2½ nautical miles;

except any part of that airspace which is within the aerodrome traffic zone of another aerodrome which is notified for the purposes of this Order as being the controlling aerodrome;

“aeronautical beacon” means an aeronautical ground light which is visible either continuously or intermittently to designate a particular point on the surface of the earth;

“aeronautical ground light” means any light specifically provided as an aid to air navigation, other than a light displayed on an aircraft;

“aeronautical radio station” means a radio station on the surface, which transmits or receives signals for the purpose of assisting aircraft;

“aeronautical telecommunications service” means a telecommunication service provided for any aeronautical purpose;

“air traffic control service” means a service provided for the purpose of preventing collisions between aircraft and, on the manoeuvring area, between aircraft and obstructions, and expediting and maintaining an orderly flow of air traffic;

“air traffic control unit” means a person appointed by the Governor or by any other person maintaining an aerodrome or place to give instructions, advice or information by means of radio signals to aircraft in the interests of safety but does not include a person so appointed solely to provide a flight information service to aircraft;

“air transport undertaking” means an undertaking whose business includes the undertaking of flights for the purposes of commercial air transport;

“annual costs” in relation to the operation of an aircraft means the best estimate reasonably practicable at the time of a particular flight in respect of the year commencing on the first day of January preceding the date of the flight of the costs of keeping and maintaining, and the indirect costs of operating, the aircraft, such costs in either case excluding direct costs and being those actually and necessarily incurred without a view to profit;

“annual flying hours” means the best estimate reasonably practicable at the time of a particular flight by an aircraft of the hours flown or to be flown by the aircraft in respect of the year commencing on the first day of January preceding the date of the flight;

“approach control service” means an air traffic control service for any aircraft which is not receiving an aerodrome control service, which is flying in, or in the vicinity of, the aerodrome traffic zone of the aerodrome in respect of which the service is being provided, whether or not the aircraft is flying by visual reference to the surface;

“approach to landing” means that portion of the flight of the aircraft when approaching to land in which it is descending below a height of 1000 feet above the relevant specified decision height or minimum descent height;

“appropriate aeronautical radio station” means in relation to an aircraft an aeronautical radio station serving the area in which the aircraft is for the time being;

“appropriate air traffic control unit” means in relation to an aircraft either the air traffic control unit notified as serving the area in which the aircraft is for the time being, or the air traffic control unit notified as serving the area which the aircraft intends to enter and with which unit the aircraft is required to communicate prior to entering that area, as the case may be;

“apron” means the part of an aerodrome provided for the stationing of aircraft for the embarkation and disembarkation of passengers, for loading and unloading of cargo and for parking;

“area navigation equipment” means equipment carried on board an aircraft which enables the aircraft to navigate on any desired flight path within the coverage of appropriate ground based navigation aids or within the limits of that on-board equipment or a combination of the two;

“ASSI” means Air Safety Support International Limited, being a wholly owned subsidiary company of the Civil Aviation Authority formed in accordance with a direction given by the Secretary of State to the Civil Aviation Authority under section 6(2)(c) of the Civil Aviation Act 1982 on 2 January 2003;

“authorised person” means any person authorised by the Governor, or, as the case may be, the Secretary of State, either generally or in relation to a particular case or class of cases, and references to a person so authorised include references to the Director of Civil Aviation or the holder for the time being of any office designated by the Governor under article 6 of this Order or any officer of the Police Authority of the Territory acting in the course of his duty;

“beneficial interest” includes interests arising under contract and other equitable interests;

“British-controlled aircraft” has the same meaning as in section 92 of the Civil Aviation Act 1982;

“British protected person” has the same meaning as in section 50 of the British Nationality Act 1981(5);

“cabin crew” in relation to an aircraft means those persons on a flight carried for the purpose of performing in the interests of the safety of passengers duties to be assigned by the operator or the pilot-in-command of the aircraft but who do not act as a member of the flight crew;

“captive balloon” means a balloon which when in flight is attached by a restraining device to the surface;

“captive flight” means flight by an uncontrollable balloon during which it is attached to the surface by a restraining device;

“cargo” includes mail and animals;

“certificated aerodrome” means an aerodrome certificated under this Order;

“certificate of airworthiness” includes any validation thereof and any flight manual, performance schedule or other document, whatever its title, incorporated by reference in that certificate relating to the certificate of airworthiness;

“certificate of release to service issued under the Order” has the meaning assigned to it by article 32(6);

“certificated for single pilot operation” means an aircraft that is not required to carry more than one pilot by virtue of any one or more of the following—

- (a) the certificate of airworthiness duly issued or rendered valid under the law of the country in which the aircraft is registered or the related flight manual;
- (b) if no certificate of airworthiness is required to be in force, the certificate of airworthiness, if any, last in force for the aircraft or the related flight manual;
- (c) if no certificate of airworthiness is or has previously been in force but the aircraft is identical in design with an aircraft in respect of which such a certificate is or has been in force, the certificate of airworthiness which is or has been in force for such an identical aircraft or the related flight manual; or
- (d) in the case of an aircraft flying in accordance with the conditions of a permit to fly issued by the Governor, that permit to fly;

“circling approach” means an extension of an instrument approach procedure which provides for visual circling of the aerodrome prior to landing;

“the Civil Aviation Authority” means the body corporate constituted in accordance with the provisions of section 2 of the Civil Aviation Act 1982;

“Class A airspace”, “Class B airspace”, “Class C airspace”, “Class D airspace” and “Class E airspace” mean airspace respectively notified as such;

“cloud ceiling” in relation to an aerodrome means the vertical distance from the elevation of the aerodrome to the lowest part of any cloud visible from the aerodrome which is sufficient to obscure more than one-half of the sky so visible;

“commercial air transport” has the meanings assigned to it by articles 195 to 200;

“commercial air transport aircraft” means an aircraft flying, or intended by the operator of the aircraft to fly, for the purpose of commercial air transport;

“the Commonwealth” means the United Kingdom, the Channel Islands, the Isle of Man, the countries mentioned in Schedule 3 to the British Nationality Act 1981 and all other territories forming part of Her Majesty’s dominions or in which Her Majesty has jurisdiction;

“competent authority” means in relation to the Territory, the Governor, and in relation to any other country the authority responsible under the law of that country for promoting the safety of civil aviation;

“conditional sale agreement” has the same meaning as in section 189 of the Consumer Credit Act 1974(6);

“congested area” in relation to a city, town or settlement, means any area that is substantially used for residential, industrial, commercial or recreational purposes;

“Contracting State” means any State (including the United Kingdom and its Territories and Dependencies) that is a party to the Convention on Civil Aviation signed on behalf of the Government of the United Kingdom at Chicago on 7 December 1944;

“controllable balloon” means a balloon which is not a small balloon and which is capable of free controlled flight;

“controlled airspace” means airspace that has been notified as Class A, Class B, Class C, Class D or Class E airspace;

“control area” means controlled airspace that has been further notified as a control area and which extends upwards from a notified altitude or flight level;

“control zone” means controlled airspace which has been further notified as a control zone and which extends upwards from the surface;

“co-pilot” in relation to an aircraft means a pilot who in performing his duties as such is subject to the direction of another pilot carried in the aircraft;

“country” includes a territory;

“crew” means any person carried in an aircraft who is—

- (a) a member of the flight crew;
- (b) a person carried on the flight deck who is assigned by the operator of the aircraft to give or to supervise the training, experience, practice and periodical tests required for the flight crew under article 99(2) of this Order;
- (c) a member of the cabin crew; or
- (d) a task specialist who is assigned by the operator to perform specialised tasks on board or from the aircraft;

“danger area” means airspace which has been notified as such within which activities dangerous to the flight of aircraft may take place or exist at such times as may be notified;

“day” means a continuous period of 24 hours beginning at midnight Co-ordinated Universal Time; or for the purposes of articles 41 and 70, the time from half an hour before sunrise until half an hour after sunset (both times exclusive), sunset and sunrise being determined at surface level;

“decision height” in relation to the operation of an aircraft at an aerodrome means the height in a precision approach or approach with vertical guidance at which a missed approach must be initiated if the required visual reference to continue that approach has not been established;

“declared distances” has the meaning which has been notified;

“direct costs” means the costs actually and necessarily incurred in connection with a flight without a view to profit but excluding any remuneration payable to the pilot for his services as such;

“director” has the same meaning as in section 250 of the Companies Act 2006(7);

“flight” and “to fly” have the meanings respectively assigned to them by paragraph (3);

“flight checking service” is a service performed for the purpose of verifying or validating the suitability of an instrument flight procedure or the performance of the navigation aids or systems that support such a procedure and the integrity of the data derived therefrom;

“flight crew” means, in relation to an aircraft, those members of the crew of the aircraft who respectively undertake to act as pilot, flight navigator, flight engineer and flight radiotelephony operator of the aircraft;

‘flight data monitoring programme’ means a programme of analysing recorded flight data in order to improve the safety of flight operations;

“flight information service unit” means a person appointed by the Governor or by any other person in charge of an aerodrome or area control centre—

- (a) in the case of such a unit appointed in respect of an aerodrome to—
  - (i) give information by means of radio signals to aircraft flying in or intending to fly within the aerodrome traffic zone of that aerodrome; and
  - (ii) grant or refuse clearance under Rule 35 or 36(1) of the Rules of the Air;
- (b) in the case of such a unit appointed in respect of an area control centre, to give information by means of radio signals to aircraft;

and “flight information service”, “aerodrome flight information service” and “aerodrome flight information service unit” shall be construed accordingly;

“flight level” means one of a series of levels of equal atmospheric pressure, separated by notified intervals and each expressed as the number of hundreds of feet which would be indicated at that level on a pressure altimeter calibrated in accordance with the International Standard Atmosphere and set to 1013.2 hectopascals;

“flight manual” means a document provided for an aircraft stating the limitations within which the aircraft is considered airworthy as defined by the appropriate airworthiness requirements, and additional instructions and information necessary for the safe operation of the aircraft;

“flight recorder” means any type of recorder installed in the aircraft for the purpose of complementing accident or incident investigations or for use in a flight data monitoring programme;

“flight visibility” means the visibility forward from the flight deck of an aircraft in flight;

“flying display” means any flying activity deliberately performed for the purpose of providing an exhibition or entertainment at an advertised event open to the public;

“flying machine” means an aeroplane, a powered lift tilt rotor aircraft, a helicopter or a gyroplane;

“free balloon” means a balloon which, when in flight, is not attached by any form of restraining device to the surface;

“free controlled flight” means flight during which a balloon is not attached to the surface by any form of restraining device (other than a tether not exceeding 5 metres in length which may be used as part of the take-off procedure) and during which the height of the balloon is controllable by means of a device attached to the balloon and operated by the pilot-in-command of the balloon or by remote control;

“general lighthouse authority” has the same meaning as in section 193 of the Merchant Shipping Act 1995<sup>(8)</sup>;

“glider” means a non-power-driven heavier-than-air aircraft which derives its lift in flight chiefly from aerodynamic reactions on surfaces which remain fixed under given conditions of flight;

“Governor” means the person for the time being administering the Government of the Territory and, in relation to such of the functions of the Governor under this Order as are specified in a designation made by the Governor under article 6, includes any person specified in that designation to carry out those functions;

“hire-purchase agreement” has the same meaning as in section 189 of the Consumer Credit Act 1974;

“holding procedure” means a predetermined manoeuvre which keeps an aircraft within a specified airspace while awaiting further clearance;

“instructor’s rating” means a flying instructor’s rating, an assistant flying instructor’s rating, a flight instructor rating (aeroplane), a flight instructor rating (helicopter), a type rating instructor rating (multi-pilot aeroplane), a type rating instructor rating (helicopter), a class rating instructor rating (single pilot aeroplane), an instrument rating instructor rating (aeroplane) or an instrument rating instructor rating (helicopter);

“instrument approach procedure” means a series of predetermined manoeuvres by reference to flight instruments, with specified protection from obstacles, from a specified point to a point from which a landing can be completed and thereafter, if a landing is not completed, to a position at which holding or other obstacle clearance criteria apply;

“instrument flight procedure” means a generic term to include individually, in whole or in part, “instrument approach procedure”, “standard instrument arrival”, “standard instrument departure”, “circling approach” and “holding procedure” designed in accordance with International Civil Aviation Organization Procedures for Air Navigation Services - Operations;

“IFR” means the Instrument Flight Rules;

“Instrument Flight Rules” means Instrument Flight Rules specified in the Rules of the Air;

“Instrument Meteorological Conditions” means weather that precludes flight in compliance with the Visual Flight Rules;

“international headquarters” means an international headquarters designated by Order in Council made under section 1 of the International Headquarters and Defence Organisations Act 1964<sup>(9)</sup> as extended to the Territory;

“to land” in relation to aircraft includes alighting on the water;

“legal personal representative” means the person so constituted as the executor, administrator, or other representative, of a deceased person;

“let-down” means, in the case of an aircraft approaching an aerodrome to land, a defined procedure designed to enable an aircraft to descend safely to a point at which it can continue the approach visually;

“licence” includes any certificate of competency or certificate of validity issued with the licence or required to be held in connection with the licence by the law of the country in which the licence is granted;

“lifejacket” means a jacket or waistcoat, incorporating inflatable buoyancy chambers, which is designed to support a person in the water;

---

(8) 1995 c. 21.

(9) 1964 c. 5.

“log book” in the case of an aircraft log book, engine log book or variable pitch propeller log book, or personal flying log book, includes a record kept either in a book, or by any other means approved by the Governor in the particular case;

“maintenance” means any one or combination of overhaul, repair, inspection, replacement, modification or defect rectification of an aircraft or aircraft component, with the exception of pre-flight inspection;

“manoeuvring area” means the part of an aerodrome provided for the take-off and landing of aircraft and for the movement of aircraft on the surface, excluding the apron and any part of the aerodrome provided for the maintenance of aircraft;

“maximum approved passenger seating configuration” means the maximum passenger seating capacity of an individual aircraft, excluding pilot seats or flight deck seats and cabin crew seats, used by the operator, approved by the competent authority and specified in the operations manual or, if no such approval has been given, the maximum number of passengers that may be carried in an aircraft under and in accordance with its certificate of airworthiness, its flight manual and this Order;

“maximum certificated take-off mass” in relation to an aircraft means the maximum total mass of the aircraft and its contents at which the aircraft may take off anywhere in the world, in the most favourable circumstances in accordance with the certificate of airworthiness in force in respect of the aircraft;

“medical attendant” means a person carried on a flight for the purpose of attending to any person in the aircraft in need of medical attention, or to be available to attend to such a person;

“microlight aeroplane” means an aeroplane designed to carry not more than two persons which has—

- (a) a maximum take-off mass not exceeding—
  - (i) 300 kg for a single seat landplane; or
  - (ii) 450 kg for a two seat landplane; or
  - (iii) 330 kg for a single seat amphibian or floatplane; or
  - (iv) 495 kg for a two seat amphibian or floatplane; or
  - (v) 315kg for a single seat landplane equipped with an airframe mounted total recovery parachute system; or
  - (vi) 472.5kg for a two-seat landplane equipped with an airframe mounted total recovery parachute system; and
- (b) a stalling speed, or minimum steady flight speed, at the maximum take-off mass not exceeding 35 knots calibrated airspeed;

“military aerodrome” means any aerodrome in the Territory that is under the control of Her Majesty’s naval, military or air forces or of any visiting force;

“military aircraft” means—

- (a) the naval, military or air force aircraft of any country;
- (b) any aircraft being constructed for the naval, military or air force of any country under a contract entered into by the Secretary of State; and
- (c) any aircraft in respect of which there is in force a certificate issued by the Secretary of State that the aircraft is to be treated for the purposes of this Order as a military aircraft;

“minimum descent height” in relation to the operation of an aircraft at an aerodrome means the height in a non-precision approach or circling approach below which descent must not be made without the required visual reference;

“nautical mile” means the International Nautical Mile, that is to say, a distance of 1852 metres;



“night” means the time from half an hour after sunset until half an hour before sunrise (both times inclusive), sunset and sunrise being determined at surface level;

“non-precision approach” means an instrument approach using non-visual aids for guidance in azimuth or elevation but which is not a precision approach;

“notified” means shown in any of the following publications for the time being in force and issued in the Territory whether before or after the coming into operation of this Order, that is to say, ‘Notams (Notices to Airmen)’, ‘Aeronautical Information Publications’, OTARs”, or such other official publications so issued for the purpose of enabling any of the provisions of this Order to be complied with;

“operator” has the meaning assigned to it by paragraph (4);

“operating site” means a place other than an aerodrome, selected by the operator or the pilot-in-command for the landing or take-off of an aircraft;

“operating staff” means the servants and agents employed by the operator, whether or not as members of the crew of the aircraft, to ensure that the flights of the aircraft are conducted in a safe manner, and includes an operator who himself performs those functions;

“OTAR” means Overseas Territories Aviation Requirements published by the Governor under article 5 or article 7 or article 74(1)(c);

“parascending parachute” means a parachute which is towed by cable in such a manner as to cause it to ascend;

“passenger” means a person other than a member of the crew;

“Performance Class 1 operations” means flights where, in the event of the failure of an engine, the helicopter will be able to safely continue the flight and land at an appropriate landing area unless the engine failure recognition occurs during take-off at or prior to reaching the take-off decision point in which case the helicopter will be able to safely land back within the area from which it has taken off;

“Performance Class 2 operations” means flights where, in the event of the failure of an engine, the helicopter will be able to safely continue the flight to an appropriate landing area or, where the failure occurs at a point during the take-off manoeuvre or the landing manoeuvre when it cannot do so, the helicopter will be able to carry out a forced landing;

“Performance Class 3 operations” means flights where, in the event of the failure of an engine at any time during the flight, the helicopter will be required to carry out a forced landing;

“pilot-in-command” in relation to an aircraft means the pilot designated by the operator as being in command and charged with the safe conduct of a flight, or, if no such designation has been made, the person who for the time being is in charge of piloting the aircraft without being under the direction of any other pilot in the aircraft;

“precision approach” means an instrument approach using precision lateral and vertical guidance;

“prescribed” means prescribed by regulations made by the Governor under this Order, and the expression “prescribe” shall be construed accordingly;

“pressurised aircraft” means an aircraft provided with means of maintaining in any compartment a pressure greater than that of the surrounding atmosphere;

“private flight” means a flight which is neither for the purpose of aerial work nor commercial air transport;

“record” includes, in addition to a record in writing—

- (a) a disc, tape, sound-track or other device in which sounds or signals are embodied so as to be capable of being reproduced from it (with or without the aid of some other instrument);

- (b) a film, tape or other device in which visual images are embodied so as to be capable of being reproduced from it (with or without the aid of some other instrument); and
- (c) a photograph;

and any reference to a copy of a record includes, in the case of a record falling within paragraph (a) only of this definition, a transcript of the sounds or signals embodied in the record, in the case of a record falling within paragraph (b) only of this definition, a still reproduction of the images embodied in the record, and in the case of a record falling within both those paragraphs, such a transcript together with such a still reproduction;

“released flight” means flight by an uncontrollable balloon during which it is not attached to the surface by any form of restraining device;

“replacement” in relation to any part of an aircraft or its equipment includes the removal and replacement of that part whether or not by the same part, and whether or not any work is done on it; but does not include the removal and replacement of a part which is designed to be removable solely for the purpose of enabling another part to be inspected, repaired, removed or replaced or cargo to be loaded;

“Rules of the Air” means the rules in Schedule 4 and any supplementary rules made by the Governor under article 67(1);

“runway visual range” in relation to a runway means the distance in the direction of take-off or landing over which the runway lights or surface markings may be seen from the touchdown zone as calculated by either human observation or instruments in the vicinity of the touchdown zone or where this is not reasonably practicable in the vicinity of the mid-point of the runway; and the distance, if any, communicated to the pilot-in-command of an aircraft by or on behalf of the person in charge of the aerodrome as being the runway visual range must be taken to be the runway visual range for the time being;

“safety management system” means a systematic approach to managing safety, including the necessary organisational structures, accountabilities, policies and procedures;

“scheduled journey” means one of a series of journeys that are undertaken between the same two places and which together amount to a systematic service;

“seaplane” includes a flying boat and any other aircraft designed to manoeuvre on water;

“sector” means part of the airspace controlled from an area control centre or other place;

“small balloon” means a balloon of not more than two metres in any linear dimension at any stage of its flight, including any basket or other equipment attached to the balloon;

“small unmanned aircraft” means any unmanned aircraft, other than a balloon or a kite, having a mass of not more than 20kg without its fuel but including any articles or equipment installed in or attached to the aircraft at the commencement of its flight;

“special VFR flight” means a flight which is a special VFR flight for the purposes of the Rules of the Air;

“specified requirements” means the OTARs;

“standard instrument arrival” means a designated IFR arrival route linking a significant point, normally on an air traffic service route, with a point from which a published instrument approach procedure can be commenced;

“standard instrument departure” means a designated IFR departure route linking the aerodrome or a specified runway of the aerodrome with a specified significant point, normally on a designated air traffic service route, at which the en-route phase of a flight commences;

“State of registry” means the Contracting State in which an aircraft is registered;

“State of the operator” means for the purposes of articles 24(1), 36(1), 45 and 82(1) the State in which the operator of an aircraft has its principal place of business (as defined in article 94(4)) or, if it has no such place of business, its permanent residence, in circumstances where—

- (a) that aircraft is registered in another Contracting State;
- (b) the operator is operating that aircraft under an agreement for its lease, charter or interchange or any similar arrangement;
- (c) the State in which the aircraft is registered has, by agreement with the State in which the operator of the aircraft has its principal place of business or, if it has no such place of business, its permanent residence, agreed to transfer to it its functions and duties as State of registry in respect of that aircraft in relation to, in the case of article 24(1), airworthiness, in the case of article 36(1), aircraft radio equipment, in the case of article 45, flight crew licensing or in the case of article 82(1), radio licensing; and
- (d) the agreement has been registered with the Council of the International Civil Aviation Organization.

“Supreme Court” means the highest court exercising original jurisdiction in respect of the Territory;

“synthetic training device” means apparatus in which flight conditions in an aircraft are simulated on the ground;

“task specialist” means a person assigned by the operator or a third party, or acting as an undertaking, who—

- (a) performs tasks on the ground directly associated with a specialised task; or
- (b) performs specialised tasks on board or from the aircraft;

“the Territory” has the meaning assigned to it by article 187 rs;

“tethered flight” means flight by a controllable balloon throughout which it is flown within limits imposed by a restraining device that attaches the balloon to the surface;

“transition altitude” means the altitude at or below which the vertical position of an aircraft is controlled by reference to altitudes;

“uncontrollable balloon” means a balloon, not being a small balloon, which is not capable of free controlled flight;

“valuable consideration” means any right, interest, profit or benefit, forbearance, detriment, loss or responsibility accruing, given, suffered or undertaken under an agreement, which is of more than a nominal nature;

“VFR” means the Visual Flight Rules;

“Visual Flight Rules” means Visual Flight Rules prescribed by the Rules of the Air;

“Visual Meteorological Conditions” means weather that permits flight in accordance with the VFR;

“with the surface in sight” means with the flight crew being able to see sufficient surface features or surface illumination to enable the flight crew to maintain the aircraft in a desired attitude without reference to any flight instrument.

(2) In this Order or in regulations made under any of the provisions of this Order references to sums expressed in terms of sterling shall be construed as references to the equivalent sums in the currency of the Territory calculated at such rate of exchange as may be prescribed or as the Governor may by order direct.

(3) An aircraft is deemed to be in flight—

- (a) in the case of a piloted flying machine, from the moment when, after the embarkation of its crew for the purpose of taking off, it first moves under its own power until the moment when it next comes to rest after landing;
- (b) in the case of a pilotless flying machine, or a glider, from the moment when it first moves for the purpose of taking off until the moment when it next comes to rest after landing;
- (c) in the case of an airship, from the moment when it first becomes detached from the surface until the moment when it next becomes attached thereto or comes to rest thereon;
- (d) in the case of a free balloon, from the moment when the balloon, including the canopy and basket, becomes separated from the surface until the moment it next comes to rest thereon; and
- (e) in the case of a captive balloon, from the moment when the balloon, including the canopy and basket, becomes separated from the surface, apart from a restraining device attaching it to the surface, until the moment when it next comes to rest thereon;

and the expressions “a flight” and “to fly” are construed accordingly.

(4) For the purposes of the application of any provision of this Order in relation to any particular aircraft, “operator” means—

- (a) subject to paragraph (b), the person who at the relevant time has the management of that aircraft;
- (b) for the purposes of Part 3, when a person other than an air transport undertaking or an aerial work undertaking has chartered, hired, leased or borrowed the aircraft for a period not exceeding 14 days that person is not considered to be the operator.

(5) The expressions appearing in the general classification of aircraft in Schedule 2 have the meanings assigned to them in that Schedule.

(6) Any power conferred by this Order to issue, make, serve or grant any instrument is construed as including a power exercisable in the like manner and subject to the like conditions, if any, to vary, revoke, cancel or otherwise terminate the instrument.

## PART 1

### POWERS AND DUTIES

#### **Regulations by the Governor**

4.—(1) The Governor may make regulations for prescribing anything that, under the provisions of this Order, is to be prescribed.

(2) A power to make regulations under this Order includes the power to make different provisions with respect to different classes of aircraft, aerodromes, persons or property and with respect to different circumstances and with respect to different parts of the Territory and to make such incidental and supplementary provisions and give instructions as are necessary or expedient for carrying out the purposes of the Order.

(3) Such regulations may prescribe the fees to be charged in connection with the issue, validation, renewal, extension or variation of any certificate, licence or other document (including the issue of a copy), or the undergoing of any examination, test, inspection or investigation or the grant of any permission or approval, required by, or for the purpose of, this Order or any regulations made under it and the method by, the time at which and the person to whom such fees must be paid.

(4) Upon an application being made in connection with which any fee is chargeable the applicant may be required, before the application is considered, to pay the whole or to deposit a portion

of the fee or fees chargeable with the Governor or to or with such other person as the regulations may require.

(5) Subject to paragraph (6), if, after payment or a deposit has been made under paragraph (4), the application is withdrawn by the applicant or otherwise ceases to have effect or is refused by the Governor, the Governor may refund the amount of such payment or deposit.

(6) Where the amount paid or deposited under paragraph (4) is wholly or to any extent attributable to a fee chargeable in respect of an investigation which would have been carried out in connection with the application if it had not been so withdrawn or ceased to have effect or been refused but which has not been carried out by reason only of such withdrawal, cessation or refusal, the Governor may refund the amount so attributable or, subject to paragraph (7), in a case where an investigation has been partially completed, so much of that amount as in the opinion of the Governor is reasonable having regard to the stage to which the investigation has progressed at the time of such withdrawal, cessation or refusal.

(7) If in any case the amount deposited by the applicant is not sufficient to cover the fee ultimately assessed to be chargeable in respect of any investigation, in so far as the same has been carried out at the time when the application is withdrawn or otherwise ceases to have effect or is refused by the Governor, the amount representing the balance of such fee shall be payable by the applicant.

(8) In this article the expression “investigation” includes an inspection, examination, calculation or test.

### **Publication of requirements**

5.—(1) Where any provision of this Order provides for the Governor to grant a certificate, licence or other document upon being satisfied as to any matters specified in the provision, to grant a rating in a licence or to require a person to keep or to do something in accordance with the specified requirements or description, the Governor must before determining whether to effect that grant or require such a person to keep or do something—

- (a) publish or cause to be published the Governor’s requirements as to those matters in the Territory by means of an OTAR; and
- (b) take into account those requirements when determining whether to grant the certificate, licence or other document or to require a person to keep or do something.

(2) Nothing in this article requires the Governor to publish requirements in respect of a licence, certificate or other document if the Governor does not exercise the powers to grant the licence, certificate or document in question.

### **Designation by the Governor**

6.—(1) Subject to paragraphs (2), (4) and (5), the Governor may designate a person to carry out those functions of the Governor under this Order that are specified in the designation, subject to such conditions as the Governor thinks fit.

(2) Subject to paragraphs (3), (4) and (5), the Governor of the Territory in which any activity takes place which is subject to any of the provisions of this Order, other than an activity described in Part 1 only of this Order, must designate a person in accordance with paragraph (1).

(3) Subject to paragraph (4) the Governor may revoke or vary a designation made under paragraph (1).

(4) Before making a designation, or revoking or varying a designation made, under paragraph (1), the Governor must consult, and take into account any advice given by, ASSI.

(5) The Governor may not include in any designation made under paragraph (1) the functions of the Governor—

- (a) to make rules, orders or regulations or give instructions under this Order; or
- (b) under this article or articles 5, 13 or 161.

### **Arrangements for giving effect to the Convention on International Civil Aviation**

7.—(1) The Governor must within the Territory issue such instructions or publish such requirements or make such arrangements as are necessary, requisite or expedient for carrying out the Convention on International Civil Aviation and implementing any Annex and any amendment to the Convention, or any such Annex made in accordance with the Convention, or generally for regulating and securing the safety of international air navigation in accordance with section 8(1) of the Act.

(2) Under the provisions of paragraph (1) the Governor must in particular—

- (a) provide or secure the provision of a meteorological service to meet the needs of international air navigation, with due regard to regional air navigation agreements and must designate the appropriate authority to provide or arrange for the provision of such meteorological service;
- (b) provide or secure the provision in the Territory of aeronautical charts that comply with the specified requirements;
- (c) arrange for the establishment and provision of search and rescue services within the Territory, and in such portions of the high seas that are the responsibility of the Territory under regional air navigation agreements; and
- (d) provide or secure the provision of an aeronautical information service.

(3) The Governor must arrange for the details of the services and arrangements provided in accordance with paragraph (2) to be included in an Aeronautical Information Publication relating to the Territory.

### **Power to prevent aircraft flying**

8.—(1) If it appears to the Governor or an authorised person that any aircraft is intended or likely to be flown—

- (a) in such circumstances that any provision of article 14, 22, 24, 40, 44, 84, 94, 100, 107, 111 or 178(2) would be contravened in relation to the flight;
- (b) in such circumstances that the flight would be in contravention of any other provision of this Order or of any regulations made under it, and be a cause of danger to any person or property whether or not in the aircraft; or
- (c) while in a condition unfit for the flight, whether or not the flight would otherwise be in contravention of any provision of this Order, or of any regulations made under it;

the Governor or that authorised person may direct the operator or the pilot-in-command of the aircraft not to permit the aircraft to make the particular flight or any other flight of such description as may be specified in the direction, until the direction has been revoked by the Governor or by an authorised person.

(2) For the purposes of paragraph (1) the Governor or any authorised person may enter upon and inspect any aircraft, and the Governor or that authorised person may take such steps as are necessary to detain the aircraft.

(3) If it appears to the Secretary of State or to the Governor or to an authorised person that any aircraft is intended or is likely to be flown in such circumstances that any provision of article 135 or 137 would be contravened in relation to the flight, the Secretary of State, the Governor or that authorised person may direct the pilot-in-command of the aircraft not to permit the aircraft to make the particular flight or any other flight of such description as may be specified in the direction until the direction has been revoked by the Secretary of State, the Governor or by an authorised person.

(4) For the purposes of paragraph (3) the Secretary of State or the Governor or any authorised person may enter upon any aerodrome and may enter upon and inspect any aircraft and the Secretary of State, or the Governor or any authorised person may take such steps as are necessary to detain the aircraft.

### **Right of access to aerodromes and other places**

9.—(1) The Governor, and any authorised person, has the right of access at all reasonable times—

- (a) to any aerodrome, including any facility provided for rescue and fire fighting at the aerodrome, for the purpose of inspecting the aerodrome;
- (b) to any aerodrome for the purpose of inspecting any aircraft on the aerodrome or any document which may be demanded under this Order, or for the purpose of detaining any aircraft under this Order;
- (c) to any place where an aircraft has landed, for the purpose of inspecting the aircraft or any document which may be demanded under this Order and for the purpose of detaining the aircraft under this Order;
- (d) to any building or place from which an air traffic control service is being provided or where any aeronautical telecommunications service requiring approval under article 153 is situated for the purpose of inspecting—
  - (i) any equipment used or intended to be used in connection with the provision of a service to an aircraft in flight or on the ground; or
  - (ii) any document or record which may be demanded under this Order.
- (e) to any place where a service described in article 7(1) and 7(2) is designed, directed, arranged or provided, for the purpose of determining whether such services are being provided satisfactorily; and
- (f) to inspect any part of, or material intended to be incorporated in or used in the manufacture of any part of, an aircraft or its equipment or any document relating to them and may for that purpose go upon any aerodrome or enter any aircraft factory or other premises, including premises used for any of the purposes of the maintenance, overhaul, repair or modification of an aircraft or of any of the material, parts or equipment installed or to be installed in an aircraft.

(2) Access to a military aerodrome may only be obtained with the permission of the person in charge of the aerodrome.

### **Exemption from the Order**

10. The Governor (including any person designated by the Governor under article 6) may exempt from any of the provisions of this Order (other than articles 12, 13, 65, 66, 135, 136, 137, 186, and 193) or any regulations made under it, any aircraft or persons or classes of aircraft or persons, either absolutely or subject to such conditions as the Governor thinks fit.

### **Revocation, suspension and variation of certificates, licences and other documents**

11.—(1) Subject to paragraph (5), the Governor may provisionally suspend or vary any certificate, licence, approval, permission, exemption, authorisation or other document issued, granted or having effect under this Order, pending inquiry into or consideration of the case.

(2) Subject to paragraph (6) the Governor may, on being satisfied as to sufficient ground being shown following due inquiry, revoke, suspend or vary any such certificate, licence, approval, permission, exemption, authorisation or other document.

(3) The holder or any person having the possession or custody of any certificate, licence, approval, permission, exemption or other document which has been revoked, suspended or varied under this Order must surrender it to the Governor within a reasonable time after being required to do so by the Governor.

(4) The breach of any condition subject to which any certificate, licence, approval, permission, exemption or other document, other than a certificate issued in respect of an aerodrome, has been granted or issued or which has effect under this Order, in the absence of provision to the contrary in the document, renders the document invalid during the continuance of the breach.

(5) Nothing in this article applies to any permission to which article 12 applies.

(6) A flight manual, performance schedule or other document incorporated by reference in the certificate of airworthiness may be varied on sufficient ground being shown to the satisfaction of the Governor, whether or not after due inquiry.

### **Revocation, suspension and variation of permissions, etc. granted under article 135 or article 137**

**12.**—(1) The Secretary of State may revoke, suspend or vary any permit to which this article applies.

(2) Save as provided by paragraph (3), the Secretary of State may exercise the powers under paragraph (1) only after notifying the permit-holder of the intention to do so and after due consideration of the case.

(3) If, by reason of the urgency of the matter, it appears to the Secretary of State to be necessary to do so, the Secretary of State may provisionally suspend or vary a permit without complying with the requirements of paragraph (2); but must in any such case comply with those requirements as soon thereafter as is reasonably practicable and must then either—

- (a) revoke the provisional suspension or variation of the permit; or
- (b) substitute for it a definitive revocation, suspension or variation, which, if a definitive suspension, may be for the same or a different period as the provisional suspension (if any) or, if a definitive variation, may be on the same or different terms as the provisional variation (if any).

(4) The powers vested in the Secretary of State by paragraph (1) and paragraph (3) may be exercised whenever, in the Secretary of State's judgement and whether or not by reason of anything done or omitted to be done by the permit-holder or otherwise connected with the permit-holder, it is necessary or expedient that the permit-holder should not enjoy, or should no longer enjoy, the rights conferred by a permit to which this article applies or should enjoy them subject to such limitations or qualifications as the Secretary of State may determine.

(5) In particular, and without prejudice to the generality of the foregoing, the Secretary of State may exercise those powers if it appears to the Secretary of State that—

- (a) the person to whom the permit was granted has committed a breach of any condition to which it is subject;
- (b) any agreement between Her Majesty's Government in the United Kingdom and the Government of any other country in pursuance of which or in reliance on which the permit was granted is no longer in force or that that other Government has committed a breach of the agreement;
- (c) the person to whom the permit was granted, or a Government which is a party to an agreement referred to in sub-paragraph (b), or the aeronautical authorities of the country concerned, have—
  - (i) acted in a manner which is inconsistent with or prejudicial to the operation in good faith, and according to its object and purpose, of any such agreement; or



(ii) engaged in unfair, discriminatory or restrictive practices to the prejudice of the holder of an Air Transport Licence granted under section 65 of the Civil Aviation Act 1982<sup>(10)</sup> or the holder of a route licence granted under that section as applied by section 69A of that Act in the operation of air services to or from points in the country concerned or of the operator of an aircraft registered in and licensed to operate from any of the Territories by regulations under section 13 of that Act in the operation of air services to or from points in the country concerned; or

(d) the person to whom the permit was granted, having been granted it as a person designated by the Government of a country other than the United Kingdom for the purposes of any such agreement, is no longer so designated or that that person has so acted, or that such circumstances have arisen in relation to that person, as to make it necessary or expedient to disregard or qualify the consequences of being so designated.

(6) The permit-holder or any person having the possession or custody of any permit which has been revoked, suspended or varied under this article must surrender it to the Secretary of State within a reasonable time of being required by the Secretary of State to do so.

(7) The breach of any condition subject to which any permit to which this article applies has been granted renders the permit invalid during the continuance of the breach.

(8) The permits to which this article applies are permissions granted by the Secretary of State or the Governor as the case may be under article 135 or article 137 and any approvals or authorisations of, or consents to, any matter which the Secretary of State or the Governor has granted, or is deemed to have granted, in pursuance of a permission which either of them has so granted.

(9) References in this article to the “permit-holder” are references to the person to whom any permit to which this article applies has been granted, or that is deemed to have been granted.

(10) The Secretary of State may, in any particular case, or class of cases, delegate to the Governor the exercise of the powers conferred on the Secretary of State under this article in respect of permissions granted by the Secretary of State or the Governor as the case may be under article 135 and any approvals or authorisations of, or consents to, any matter which the Secretary of State or the Governor has granted, or is deemed to have granted, in pursuance of a permission which either of them has so granted.

### **Review by the Governor**

**13.—**(1) Where any person designated under article 6—

- (a) decides that it would be inexpedient in the public interest to register an aircraft in the Territory; or
- (b) refuses an application for the grant, validation or variation of a licence, certificate, approval, authorisation or rating; or
- (c) decides to cancel the registration of an aircraft; or
- (d) decides to revoke, suspend or vary a licence, certificate, approval, authorisation, validation or rating otherwise than on the application of the holder;

the person designated must serve on the person concerned a notice stating the reasons for the decision and the person concerned may, within 14 days of the date of the service of the notice, serve on the Governor a request that the decision be reviewed by the Governor.

(2) Where such a request under paragraph (1) has been duly served the Governor must, before making a decision, consider any oral representations which may be made to the Governor or any representations in writing which may have been served upon the Governor by the person concerned within 21 days after the date of service of the request and may, before making a decision, consider

---

<sup>(10)</sup> 1982 c.16.

the advice of such technical assessors as the Governor may appoint as advisers, provided that the Governor must not appoint as an assessor any person who participated in the decision or proposal or in giving or assessing any test or examination which is to be the subject of the Governor's decision.

## PART 2

### REGISTRATION AND MARKING OF AIRCRAFT

#### Aircraft to be registered

14.—(1) An aircraft must not fly in or over the Territory unless it is registered in—

- (a) a Contracting State; or
- (b) some other country with which there is in force an agreement between Her Majesty's Government in the United Kingdom and the Government of that country which makes provision for the flight over the Territory of aircraft registered in that country.

(2) Any aircraft may fly unregistered on any flight which—

- (a) begins and ends in the Territory without passing over any other country; and
- (b) is in accordance with the conditions of a permit issued by the Governor.

(3) Paragraph (1) does not apply to any kite or captive balloon.

(4) If an aircraft flies in or over the Territory in contravention of paragraph (1) in such manner or circumstances that if the aircraft had been registered in the Territory an offence against this Order would have been committed, the same offence is deemed to have been committed in respect of that aircraft.

#### Registration of aircraft in the Territory

15.—(1) The Governor is the authority for the registration of aircraft in the Territory and is responsible for maintaining the register in a legible form.

(2) An aircraft must not be registered or continue to be registered in the Territory if it appears to the Governor that—

- (a) the aircraft is registered outside the Territory and that such registration does not cease by operation of law upon the aircraft being registered in the Territory;
- (b) an unqualified person holds any legal or beneficial interest by way of ownership in the aircraft or any share in the aircraft;
- (c) the aircraft could more suitably be registered in some other Contracting State; or
- (d) it would be inexpedient in the public interest for the aircraft to be or to continue to be registered in the Territory.

#### Qualifications for registration

16.—(1) The following persons are qualified to hold a legal or beneficial interest by way of ownership in an aircraft registered in the Territory or a share therein—

- (a) the Crown in right of Her Majesty's Government in the United Kingdom or in right of the Government of the Territory;
- (b) British Nationals, British Overseas Territories Citizens and British protected persons;
- (c) persons ordinarily resident or domiciled in the Territory;

(d) bodies incorporated and having a registered office in the Territory or in the United Kingdom.

(2) If an unqualified person residing or having a place of business in the Territory holds a legal or beneficial interest by way of ownership in an aircraft, or a share in an aircraft, the Governor may register the aircraft in the Territory upon being satisfied that the aircraft may otherwise be properly registered.

(3) If an unqualified person has registered an aircraft under paragraph (2), that aircraft must not be used for the purpose of commercial air transport or aerial work while it is so registered.

(4) If an aircraft is chartered by demise to a qualified person the Governor may, whether or not an unqualified person is entitled as owner to a legal or beneficial interest in the aircraft, register the aircraft in the Territory in the name of the charterer by demise upon being satisfied that the aircraft may otherwise be properly registered.

(5) Subject to the provisions of this Part, an aircraft registered under paragraph (4) may remain registered during the continuation of the charter.

### **Application for registration**

17.—(1) An application for registration of an aircraft in the Territory must be made in writing to the Governor and must include or be accompanied by the particulars and information specified in the Governor's published requirements.

(2) Upon receiving an application for the registration of an aircraft in the Territory, the Governor must register the aircraft upon being satisfied that the aircraft may properly be so registered and must include in the register such particulars that the Governor may specify.

(3) The Governor must supply to the registered owner a certificate of registration.

### **Changes to the register**

18.—(1) If, at any time after an aircraft has been registered in the Territory, an unqualified person becomes entitled to a legal or beneficial interest by way of ownership in the aircraft or a share in the aircraft, the registration of the aircraft becomes void and the registered owner must immediately return the certificate of registration to the Governor.

(2) Any person who is the registered owner of an aircraft registered in the Territory must immediately inform the Governor in writing of—

- (a) any change in the information that was supplied to the Governor when the application was made for the registration of the aircraft;
- (b) the destruction of the aircraft, or its permanent withdrawal from use; or
- (c) the termination of the demise charter in the case of an aircraft registered under article 16(4).

(3) Any person who becomes the owner of an aircraft registered in the Territory must inform the Governor in writing within 28 days of becoming the owner.

(4) The Governor may, whenever it appears necessary or appropriate to do so for giving effect to this Part or to correct or bring the register up to date, amend the register or cancel the registration of an aircraft, and the Governor must cancel that registration within two months upon being satisfied that there has been a change in the ownership of the aircraft.

### **General provisions**

19.—(1) The Governor may, by regulations, adapt or modify the provisions of this Part as the Governor considers necessary or expedient for the purpose of providing for the temporary transfer

of aircraft to or from the Territory register, either generally or in relation to a particular case or class of cases.

(2) In this Part references to an interest in an aircraft do not include references to an interest in an aircraft to which a person is entitled only by virtue of membership of a flying club and references in this Part to the registered owner of an aircraft includes, in the case of a deceased person, his or her legal personal representative, and in the case of a body corporate which has been dissolved, its successor.

(3) Nothing in this Part requires the Governor to cancel the registration of an aircraft if the Governor does not consider it in the public interest to do so.

#### **Aircraft subject to a mortgage**

**20.** The registration of an aircraft which is the subject of an undischarged mortgage entered in the Register of Aircraft Mortgages kept in the Territory under legislation in force in the Territory relating to the mortgaging of aircraft, does not become void by virtue of this Part, nor without prejudice to the Governor's powers under articles 15(2) and 18(4) may the Governor cancel the registration of such an aircraft under this Part unless all persons shown in the Register of Aircraft Mortgages as mortgagees of that aircraft have consented to the cancellation.

#### **Provision of information**

**21.** When requested to do so the Governor must transmit to the Civil Aviation Authority particulars of all registrations, and of changes in or cancellations of registrations, entered in the register in such form as the Civil Aviation Authority specifies.

#### **Nationality and registration marks**

**22.—(1)** An aircraft (other than an aircraft permitted by or under this Order to fly without being registered) must not fly unless it has painted or fixed on it, in the manner required by the law of the country in which it is registered, the nationality and registration marks required by that law.

(2) The nationality mark to be borne by aircraft registered in the Territory shall consist of a group of two capital letters in Roman character and the registration mark shall consist of a group of three capital letters in Roman character and both the nationality mark and the registration mark must comply with requirements published by the Governor under article 5.

(3) An aircraft must not bear any marks which would indicate—

- (a) that the aircraft is registered in a country in which it is not in fact registered; or
- (b) that the aircraft is a State aircraft of a particular country if it is not in fact such an aircraft, unless the appropriate authority of that country has sanctioned the bearing of such marks.

(4) Marks approved by the Governor for the purposes of flight in accordance with a permit to fly do not mean that the aircraft is registered in a country in which it is not in fact registered.

## **PART 3**

### **AIRWORTHINESS AND EQUIPMENT OF AIRCRAFT**

#### **Type Acceptance Certificate**

**23.—(1)** A certificate of airworthiness for an aircraft registered in the Territory must not be issued unless there is in force a Type Acceptance Certificate issued by the Governor for that aircraft type.

(2) Any person who intends to operate an aircraft to be registered in the Territory of a type for which a Type Acceptance Certificate has not been issued must apply, or cause an application to be made, to the Governor for the issue of a Type Acceptance Certificate for that aircraft type in accordance with this article and the published requirements of the Governor.

(3) A “Type Acceptance Certificate” means a document issued by the Governor for an aircraft on the basis of a Type Certificate for that aircraft type that is acceptable to the Governor.

(4) A “Type Certificate” means a document issued by a Contracting State or the European Aviation Safety Agency on behalf of the European Union Member States to define the design of an aircraft type and to certify that the design meets the appropriate airworthiness requirements of that State.

### **Certificate of airworthiness to be in force**

**24.**—(1) An aircraft must not fly unless—

- (a) there is in force for the aircraft a certificate of airworthiness issued or rendered valid under the law of the country in which the aircraft is registered, or the State of the operator; and
- (b) any conditions subject to which the certificate was issued or rendered valid are complied with.

(2) The prohibition in paragraph (1) does not apply to flights made wholly within the Territory, of—

- (a) a glider, flying on a private flight or an aerial work flight which consists of the giving of instruction in flying or the conduct of flying tests in a flying club environment;
- (b) a balloon flying on a private flight;
- (c) a kite;
- (d) an aircraft flying in accordance with a permit to fly issued by the Governor under article 28.

(3) In the case of an aircraft registered in the Territory the certificate of airworthiness referred to in paragraph (1) is a certificate issued under article 25.

### **Issue, renewal and validity of certificate of airworthiness**

**25.**—(1) The Governor must issue a certificate of airworthiness for any aircraft upon being satisfied that the specified requirements have been complied with and on being satisfied that the aircraft is fit to fly having regard to—

- (a) the design, construction, workmanship and materials of the aircraft, including in particular any engines fitted in the aircraft, and of any equipment carried in the aircraft which is necessary for the airworthiness of the aircraft;
- (b) the results of flying trials, and such other tests of the aircraft as the Governor may require; and
- (c) subject to paragraph (2), the issue of a certificate of release to service under and in accordance with the provisions of article 32.

(2) A certificate of release to service is not required in respect only of the re-issue of a certificate of airworthiness under paragraph (1).

(3) Nothing in this Order obliges the Governor to accept an application for the issue of a certificate of airworthiness or for the variation or re-issue of any such certificate when the application is not supported by such reports from such persons as the Governor may specify (either generally or in a particular case or class of cases).

### **Continued airworthiness**

**26.**—(1) An aircraft registered in the Territory for which a certificate of airworthiness is in force must not fly unless—

- (a) the aircraft is maintained in accordance with an approved maintenance programme;
- (b) the aircraft's maintenance and continued airworthiness (including that of its engines, equipment and radio station) is managed by a person or organisation approved by the Governor in accordance with the specified requirements;
- (c) all mandatory airworthiness or equivalent directives issued by the State responsible for the certification standard of the aircraft have been complied with;
- (d) all inspections required in respect of the aircraft under the provisions of this Order have been completed; and
- (e) a flight manual or equivalent document is available for use by the flight crew containing—
  - (i) the limitations within which the aircraft is considered airworthy; and
  - (ii) such additional instructions and information as may be necessary to secure compliance with the specified performance and operational requirements relating to that aircraft.

(2) The operator of an aircraft registered in the Territory that is operated under an air operator certificate issued under article 94 must appoint a post holder acceptable to the Governor on the basis of that person's training, qualifications and experience, who is responsible for the continued airworthiness management of the aircraft.

(3) The operator, owner or, where an aircraft is chartered by demise, the lessee of an aircraft—

- (a) which is registered in the Territory;
- (b) of which the maximum certificated take-off mass exceeds 2700 kg; and
- (c) that is not operated for commercial air transport purposes by the holder of an air operator's certificate issued under article 94;

must appoint a technical coordinator, acceptable to the Governor, who must ensure that arrangements for continued airworthiness management are established in accordance with the specified requirements.

### **Certificate of airworthiness ceasing to be in force**

**27.**—(1) Subject to paragraph (2), a certificate of airworthiness ceases to be in force—

- (a) whilst the aircraft, or such of its equipment as is necessary for the airworthiness of the aircraft, is being or has been overhauled, repaired, replaced, modified or maintained;
- (b) if maintenance of the aircraft or of any equipment necessary for the airworthiness of the aircraft is required by a maintenance programme approved by the Governor for that aircraft under article 26(1)(a);
- (c) if any part of the aircraft or of such equipment is modified, is removed or is replaced, otherwise than in a manner and with material of a type approved by the Governor for the purpose either generally or in relation to a class of aircraft or to the particular aircraft;
- (d) until the satisfactory completion of any inspection for the purpose of ascertaining whether the aircraft remains airworthy which is or has been—
  - (i) made mandatory by the Governor;
  - (ii) required by a maintenance programme approved by the Governor for that aircraft;

- (e) until the satisfactory completion of any modification of the aircraft or of any of its equipment that is made mandatory by the Governor for the purpose of ensuring that the aircraft remains airworthy.
- (2) A certificate of airworthiness that has ceased to be in force under paragraph (1) becomes valid again on the issue of a certificate of release to service under this Order relating to the overhaul, repair, replacement, modification, maintenance or inspection.

#### **Issue, re-issue etc of permit to fly**

**28.**—(1) The Governor may issue for any aircraft a permit to fly upon being satisfied that the aircraft is fit to fly having regard to the airworthiness of the aircraft and the conditions to be attached to the permit.

(2) The Governor must refuse to issue a permit to fly for an aircraft if it appears that the aircraft is eligible for and ought to fly under and in accordance with a certificate of airworthiness.

(3) Subject to paragraph (4) an aircraft flying in accordance with a permit to fly must not fly for the purpose of commercial air transport or aerial work.

(4) With the permission of the Governor, an aircraft flying in accordance with a permit to fly may fly for the purpose of aerial work which consists only of giving instruction in flying or the conduct of flying tests.

(5) A person who is not a member of the flight crew must not be carried during flights under a permit to fly unless the prior permission of the Governor has been obtained.

(6) A placard must be fixed to any aircraft, flying in accordance with a permit to fly, in full view of the occupants, which must be worded as follows—

“Occupant Warning – This aircraft has not been certificated to an International Requirement”.

(7) An aircraft flying in accordance with a permit to fly must only be flown in accordance with such conditions specified by the Governor as shall be appropriate having regard to all of the circumstances of the flight.

(8) Nothing in this Order obliges the Governor to accept an application for the issue, variation or renewal of a permit to fly unless the application is supported by such reports from such authorised or approved persons as the Governor may specify (either generally or in a particular case or class of cases).

#### **Permit to fly ceasing to be in force**

**29.** A permit to fly issued for an aircraft ceases to be in force—

- (a) if any conditions of the permit are not complied with;
- (b) until the completion of any inspection, modification or maintenance of the aircraft or any of its equipment, required for ascertaining whether the aircraft remains airworthy and—
  - (i) made mandatory by the Governor; or
  - (ii) required as a condition of the permit to fly;
- (c) if the aircraft, engines or propellers, or such of its equipment as is necessary for the airworthiness of the aircraft, are modified or repaired; unless the repair or modification has been approved by the Governor or by a person or organisation approved by the Governor for the purpose.

#### **Aircraft records**

**30.**—(1) The following aircraft records must be kept for an aircraft registered in the Territory—

- (a) an aircraft logbook;
- (b) a separate logbook for each engine fitted in the aircraft; and
- (c) a separate logbook for each variable pitch propeller fitted to the aircraft.

(2) A technical log must be kept for every aircraft registered in the Territory for which a certificate of airworthiness is in force.

(3) A record in a form acceptable to the Governor may be kept instead of a technical log in the case of an aircraft of which the maximum certificated take-off mass is 2700 kg or less and which is not operated by the holder of an air operator's certificate granted under article 94.

(4) Subject to paragraph (5) the technical log referred to in this article must be carried in the aircraft when article 167 so requires and copies of the entries referred to in this article must be kept on the ground.

(5) If it is not reasonably practicable for the copy of the technical log or approved record to be kept on the ground it may be carried in the aircraft in a container acceptable to the Governor for that purpose.

(6) The technical log and logbooks referred to in paragraphs (1) and (2) must be in a form acceptable to the Governor and must include the particulars and be kept in a manner specified by the Governor.

### **Completion and retention of records**

**31.**—(1) At the end of every flight by an aircraft registered in the Territory to which the provisions of article 30 apply the pilot-in-command of the aircraft must enter in a technical log or approved record, as the case may be—

- (a) the times when the aircraft took off and landed;
- (b) particulars of any defect which is known to the pilot-in-command and which affects the airworthiness or safe operation of the aircraft; and
- (c) such other particulars in respect of the airworthiness or operation of the aircraft as the Governor may require;

and must sign and date such entries.

(2) In the case of a number of consecutive flights each of which begins and ends—

- (a) within a period of 24 hours;
- (b) with the same person as pilot-in-command of the aircraft;

the pilot-in-command may, except where the pilot becomes aware of a defect during an earlier flight, make the entries specified in paragraph (1) at the end of the last of such consecutive flights.

(3) When any defect which has been or should have been entered in a technical log or approved record is rectified, the person issuing a certificate of release to service under this Order in respect of that defect must enter the certificate in the technical log or approved record in such a position as to be readily identifiable with the defect to which it relates.

(4) Each entry in a logbook required under article 30(1) must be made—

- (a) as soon as practicable after the occurrence to which it relates; and
- (b) on each occasion that any overhaul, repair, replacement, modification, maintenance or inspection is undertaken on the engine or propeller.

(5) Any document or electronic record that has been incorporated by reference in a logbook is deemed, for the purposes of this Order, to be part of the logbook.



(6) It is the duty of the operator of every aircraft, for which technical logs and logbooks are required to be kept, to keep or preserve them or cause them to be kept or preserved in accordance with specified requirements.

### **Requirement for a certificate of release to service**

**32.**—(1) This article applies to any aircraft registered in the Territory for which a certificate of airworthiness has been, or is to be, issued under article 25.

(2) If an aircraft or any part of the aircraft or such of its equipment as is necessary for the airworthiness of the aircraft has been—

- (a) overhauled, repaired, replaced, modified or maintained; or
- (b) inspected as provided in article 27(1)(d);

that aircraft must not fly unless a certificate of release to service issued under this Order is in force for the aircraft.

(3) In the circumstances specified in paragraph (4), a certificate of release to service is not required to be in force for an aircraft for which a certificate of airworthiness is in force if—

- (a) the maximum certificated take-off mass does not exceed 2700kg; and
- (b) it is not operated for the purpose of commercial air transport or aerial work.

(4) The circumstances referred to in paragraph (3) are—

- (a) the only repairs or replacements for which a certificate of release to service is not in force are of a description specified by the Governor;
- (b) such repairs or replacements have been carried out personally by the holder of a pilot's licence, granted or rendered valid under this Order, who is the owner or operator of the aircraft;
- (c) the person carrying out the repairs or replacements enters in the aircraft log book, kept for the aircraft under article 30, a record which identifies the repairs or replacement and sign and date the entries; and
- (d) any equipment or parts used in carrying out such repairs or replacements are of a type approved by the Governor either generally for a class of aircraft or for the particular aircraft.

(5) Neither—

- (a) equipment provided in compliance with article 35; nor
- (b) radio apparatus provided for use in an aircraft or in any survival craft carried in an aircraft, whether or not the apparatus is provided in compliance with this Order,

must be installed or placed on board for use in an aircraft to which this article applies after being maintained, overhauled, repaired, modified or inspected, unless a certificate of release to service issued under this Order is in force for it at the time when it is installed or placed on board.

(6) A certificate of release to service issued under this Order must certify that the aircraft or any part of it or its equipment has been inspected, overhauled, repaired, replaced, modified or maintained, as the case may be, in a manner and with material of a type approved by the Governor either generally or in relation to the particular aircraft or class of aircraft and include particulars of the work done.

(7) A certificate of release to service issued under this Order may be issued only by a person authorised by the Governor, either generally or in a particular case or class of cases, in accordance with the specified requirements.

### **Licensing and authorisations of maintenance engineers**

**33.**—(1) The Governor must grant an aircraft maintenance engineer’s licence upon being satisfied that the applicant—

- (a) is a fit person to hold the licence;
- (b) is qualified by having the knowledge, experience, competence and skill in aeronautical engineering; and
- (c) meets the specified requirements for holding such a licence.

(2) An aircraft maintenance engineer’s licence authorises the holder, subject to such conditions as may be specified in the licence, to issue certificates of release to service under this Order in respect of such repairs, replacements, modifications, maintenance and inspections of such aircraft and such equipment as may be so specified.

(3) For the purposes of paragraph (1) the applicant must supply such evidence and undergo such examinations and tests as the Governor may require.

(4) The Governor may validate, for the purposes of this Order, an aircraft maintenance engineer’s licence granted under the law of a country other than the Territory.

(5) A licence granted under this article is not valid unless it has been signed by the holder in ink.

(6) The Governor may, for the purposes of this article—

- (a) approve any course of training or instruction;
- (b) authorise a person to conduct specified examinations or tests; and
- (c) approve a person to provide or conduct any course of training or instruction.

(7) The holder of an aircraft maintenance engineer’s licence must not exercise the privileges of such a licence if the holder knows or suspects that their physical or mental condition renders them unfit to exercise such privileges.

(8) When exercising the privileges of a licence, the holder of an aircraft maintenance engineer’s licence must not be under the influence of alcohol, any drug or any psychoactive substance, including prescribed or proprietary medication, so as to render the holder unable safely and properly to exercise such privileges or so as to create a risk to the licence holder or to any other person.

### **Maintenance approval**

**34.**—(1) A person intending to engage in—

- (a) any stage of the maintenance of aircraft, aircraft components or aircraft materials;
- (b) the manufacture of parts for the purpose of maintenance; or
- (c) associated training activities;

must not do so without first obtaining from the Governor a certificate of approval in respect of any of those activities.

(2) The Governor must issue an approval to an organisation that complies with the specified requirements.

(3) A certificate of approval must be in such form, be subject to such conditions and limitations and contain such particulars as may be determined by the Governor.

### **Equipment of aircraft**

**35.**—(1) An aircraft must not fly unless it is equipped so as to—

- (a) comply with the law of the country in which it is registered or of the State of the operator;
- (b) enable lights and markings to be displayed; and

- (c) enable signals to be made;

in accordance with this Order and any regulations made under it.

(2) In the case of any aircraft registered in the Territory the equipment to be provided (in addition to any other equipment required by or under this Order) must—

- (a) comply with instructions given by the Governor under article 74(1)(d) or with the specified requirements as applicable to the purpose and the circumstances of the flight;
- (b) be of a type approved by the Governor either generally or in relation to a class of aircraft or in relation to that aircraft; and
- (c) be installed in a manner approved by the Governor.

(3) In any particular case or class of cases the Governor may give instructions that an aircraft registered in the Territory must carry such additional equipment or supplies (including radio equipment) as may be specified for the purpose of—

- (a) facilitating the navigation of the aircraft;
- (b) the carrying out of search and rescue operations; or
- (c) securing the safety and the survival of the persons carried in the aircraft.

(4) The equipment carried or to be carried under this article must be installed or stowed, and kept stowed, and maintained and adjusted so as to be readily accessible and capable of being used by the person or persons for whose use it is intended.

(5) The position of equipment provided for emergency use must be indicated by clear markings in or on the aircraft.

(6) All equipment installed or carried in an aircraft, whether or not in compliance with this article, must be installed or stowed and maintained and adjusted so as not to be a source of danger in itself or to impair the airworthiness of the aircraft or the proper functioning of any equipment or services necessary for the safety of the aircraft.

### **Radio equipment of aircraft**

**36.**—(1) An aircraft must not fly unless it is equipped with radio and radio navigation equipment so as to—

- (a) comply with the law of the country in which the aircraft is registered or of the State of the operator; and
- (b) enable communications to be made and the aircraft to be navigated, in accordance with the provisions of this Order and any regulations made under it.

(2) Subject to paragraphs (3) and (4), for an aircraft registered in the Territory the radio equipment and radio navigation equipment that is required to be provided must comply—

- (a) with instructions given by the Governor under article 74(1)(d); or
- (b) with the Governor's specified requirements applicable to the purpose and circumstances of the flight.

(3) The radio and radio navigation equipment provided in accordance with paragraph (2) must be—

- (a) of a type approved by the Governor generally or in relation to a class of aircraft or in relation to that aircraft; and
- (b) installed in a manner approved by the Governor.

(4) Subject article 37(2) and to such exceptions as may be specified by the Governor in instructions or requirements, the radio and radio navigation equipment provided in compliance with paragraph (2) must always be maintained in serviceable condition.

### **Minimum equipment requirements**

**37.**—(1) The Governor may grant for any aircraft or class of aircraft registered in the Territory an approval permitting such aircraft to commence a flight in specified circumstances notwithstanding that any specified item of equipment required by or under this Order to be carried in the circumstances of the intended flight is not carried or is not in a fit condition for use.

(2) An aircraft registered in the Territory must not commence a flight if any of the equipment (including radio apparatus) required by or under this Order to be carried in the circumstances of the intended flight is not carried or is not in a fit condition for use unless—

- (a) the aircraft does so under the terms of an approval granted under paragraph (1) to the operator and in accordance with a Minimum Equipment List approved by the Governor; and
- (b) in the case of an aircraft to which articles 96 or 134 apply, the applicable operations manual contains the particulars of that approval.

### **Aircraft weight schedule**

**38.**—(1) Every aircraft for which a certificate of airworthiness or permit to fly issued under this Order is in force must be weighed, and the position of its centre of gravity determined, at such times and in such a manner as the Governor may require or approve in the case of that aircraft.

(2) When the aircraft is weighed the operator of the aircraft must prepare a weight schedule showing—

- (a) either the basic weight or such other weight as may be approved by the Governor for that aircraft; and
- (b) either the position of the centre of gravity of the aircraft at its basic weight or such other position of the centre of gravity as may be approved by the Governor for that aircraft.

(3) Subject to article 171, the weight schedule must be preserved by the operator of the aircraft for at least six months after the next occasion on which the aircraft is weighed for the purposes of this article.

(4) In this article “basic weight” means the empty weight of the aircraft established in accordance with the type certification basis of the aircraft.

### **Inspection for airworthiness purposes**

**39.** The Governor may require such inspections, investigations, tests, experiments and flight trials to be made as the Governor deems necessary for the purposes of this Part of this Order.

## **PART 4**

### **AIRCRAFT CREW AND LICENSING**

#### **Composition of crew of aircraft**

**40.**—(1) An aircraft must not fly unless it carries a flight crew of the number and description required by the law of the country in which it is registered.

(2) An aircraft registered in the Territory must carry a flight crew adequate in number and description to ensure the safety of the aircraft.

(3) An aircraft registered in the Territory which has a flight manual, must carry a flight crew of at least the number and description specified in the flight manual.

(4) An aircraft registered in the Territory which does not have a flight manual must carry a flight crew of at least the number and description specified by the Governor in the certificate of airworthiness or permit to fly.

(5) An aircraft registered in the Territory, which is required by article 36 to be equipped with radio communication equipment, must carry a flight radiotelephony operator as a member of the flight crew.

#### **Pilots required on commercial air transport flights**

**41.**—(1) An aircraft registered in the Territory which is—

- (a) an aeroplane powered by one or more turbine jets;
- (b) an aeroplane powered by one or more turbine propeller engines and with a maximum approved passenger seating configuration of more than 9; or
- (c) a helicopter with a maximum approved passenger seating configuration of more than 9; and
- (d) flying for the purpose of commercial air transport,

must carry at least two pilots as members of the flight crew.

(2) An aircraft registered in the Territory flying for the purposes of commercial air transport, other than an aircraft described in paragraph (1)(a), (b) or (c) must carry at least two pilots as members of the flight crew if it is flying in circumstances where the pilot-in-command is required to comply with the instrument flight rules or is flying at night unless—

- (a) use of a single pilot is approved by the Governor; or
- (b) it is a helicopter flying by day and remaining clear of cloud and with the surface in sight.

#### **Required cabin crew of aircraft**

**42.**—(1) This article applies to each commercial air transport aircraft registered in the Territory which has a maximum approved passenger seating configuration of more than 19 and on which at least one passenger is carried.

(2) The crew of an aircraft on such a flight must include cabin crew carried for the purposes of performing, in the interests of the safety of passengers, duties to be assigned by the operator or the pilot-in-command of the aircraft but who must not act as members of the flight crew.

(3) On such a flight not less than one cabin crew member must be carried for every 50 or fraction of 50 passenger seats installed in the aircraft.

(4) The number of members of the cabin crew calculated in accordance with paragraph (3) need not be carried if—

- (a) the Governor has granted written permission to the operator to carry a lesser number on that flight; and
- (b) the operator carries the number specified in that permission and complies with any conditions subject to which the permission is granted.

#### **Power to direct additional crew to be carried**

**43.** The Governor may, in the interests of safety, direct the operator of any aircraft registered in the Territory that all or any aircraft operated by it, when flying in circumstances specified in the direction, must carry, in addition to the crew required to be carried by this Part, such additional persons as members of the flight crew or cabin crew as may be specified in the direction.

### **Members of flight crew - requirement for licence**

44.—(1) A person must not act as a member of the flight crew of an aircraft registered in the Territory without holding an appropriate licence granted or rendered valid under this Order.

(2) An appropriate licence for the purposes of this Part means a licence which entitles the holder to perform the functions being undertaken in relation to the aircraft concerned on the particular flight.

(3) The holder of a licence, endorsed to the effect that the holder does not satisfy in full the relevant international standard and which has been granted or rendered valid under this Order, must not act as a member of the flight crew of an aircraft registered in the Territory in or over the territory of a Contracting State other than the Territory except in accordance with permission granted by the competent authority of that State.

(4) The holder of a licence granted or rendered valid under the law of a Contracting State other than the Territory, being a licence endorsed as provided in paragraph (3), must not act as a member of the flight crew of any aircraft in or over the Territory except in accordance with permission granted by the Governor, whether or not the licence is rendered valid under this Order.

### **Requirement for appropriate licence – non-Territory registered aircraft**

45. A person must not act as a member of the flight crew required by this Order to be carried in an aircraft registered in a country other than the Territory unless—

- (a) in the case of an aircraft flying for the purpose of commercial air transport or aerial work, that person is the holder of an appropriate licence granted or rendered valid under the law of the country in which the aircraft is registered or the State of the operator; or
- (b) in the case of an aircraft on a private flight, that person is the holder of an appropriate licence granted or rendered valid under the law of the country in which the aircraft is registered or under this Order, and the Governor does not in the particular case give a direction to the contrary.

### **Flight crew licence requirements – exception to act as flight radiotelephony operator**

46. A person may act as a flight radiotelephony operator within the Territory without being the holder of an appropriate licence granted or rendered valid under this Order if that person—

- (a) is being trained in an aircraft registered in the Territory to perform duties as a member of the flight crew of an aircraft; and
- (b) is authorised to operate the radiotelephony station by the holder of the licence granted for that station under any enactment.

### **Flight crew licence requirements – exception for solo flying training**

47.—(1) A person may act as pilot-in-command of an aircraft for the purpose of becoming qualified for the grant or renewal of a pilot's licence or the inclusion or variation of any rating in a pilot's licence, without being the holder of an appropriate licence granted or rendered valid under this Order, if the conditions referred to in paragraph (2) are satisfied.

(2) The conditions referred to in paragraph (1) are that—

- (a) the person is at least 16 years of age;
- (b) the person is the holder of a valid medical certificate issued by a person approved by the Governor to the effect that the person is fit to act as pilot in command;
- (c) the person complies with any conditions subject to which that medical certificate was issued;
- (d) no other person is carried in the aircraft;

- (e) the aircraft is not flying for the purpose of commercial air transport or aerial work other than aerial work which consists of giving instruction in flying or conducting flying tests; and
- (f) the person acts in accordance with instructions given by another person holding a pilot's licence granted under this Order, being a licence which includes a flying instructor's rating, entitling that other person to give instruction in flying the type of aircraft being flown.

#### **Flight crew licence requirements – exception for dual flying training**

**48.**—(1) A person may act as pilot of an aircraft of which the flight crew required to be carried by or under this Order is not more than one pilot for the purpose of becoming qualified for the grant or renewal of a pilot's licence or the inclusion or variation of any rating in a pilot's licence without being the holder of an appropriate licence granted or rendered valid under this Order if the conditions in paragraph (2) are satisfied.

(2) The conditions referred to in paragraph (1) are that—

- (a) the aircraft is not flying for the purpose of commercial air transport or aerial work other than aerial work which consists of giving instruction in flying or conducting flying tests;
- (b) the person acts in accordance with instructions given by another person holding a pilot's licence granted under this Order, being a licence which includes a flying instructor rating entitling that other person to give instruction in flying the type of aircraft being flown; and
  - (i) the aircraft is fitted with dual controls and the person is accompanied in the aircraft by the instructor who is seated at the other set of controls; or
  - (ii) the aircraft is fitted with controls designed for and capable of use by two persons and the person is accompanied in the aircraft by the instructor who is seated so as to be able to use the controls.

#### **Flight crew licence requirement – exception for flight engineers**

**49.** A person may act as a member of the flight crew (otherwise than as a pilot) of an aircraft registered in the Territory without being the holder of an appropriate licence if—

- (a) the flight is for the purpose of undergoing training or tests for the grant or renewal of a flight engineer's licence or for the inclusion, renewal or extension of a rating in such a licence; and
- (b) the person acts under the supervision and in the presence of another person who is the holder of the type of licence or rating for which the person undergoing the training or tests is being trained or tested.

#### **Flight crew licence – exception for members of HM Forces**

**50.** A person may act as a member of the flight crew of an aircraft registered in the Territory without being the holder of an appropriate licence if, in so doing, the person is acting in the course of his or her duty as a member of any of Her Majesty's naval, military or air forces.

#### **Grant, renewal and effect of flight crew licences**

**51.**—(1) The Governor must grant a licence of any of the classes specified in Schedule 3, authorising the holder to act as a member of the flight crew of an aircraft registered in the Territory, upon being satisfied that the applicant—

- (a) is a fit person to hold the licence; and

- (b) is qualified by having the knowledge, experience, competence, skill and physical and mental fitness to act in the capacity to which the licence relates; and
  - (c) complies with the specified requirements.
- (2) For the purposes of paragraph (1) the applicant must provide evidence and undergo such examinations and tests and undertake such courses of training as the Governor requires.
- (3) A licence granted under this article is not valid unless it is signed by the holder in ink.
- (4) Subject to article 11, a licence remains in force for the period indicated in the licence and if no period is indicated it remains in force for the lifetime of the holder.
- (5) The Governor may renew a licence from time to time upon being satisfied that the holder is a fit person and is qualified in accordance with paragraph (1).
- (6) A licence of any class must not be granted to any person who is under the minimum age specified for that class of licence.
- (7) The Governor may include in a licence a rating of any of the classes specified in the specified requirements, upon being satisfied that the applicant is qualified to act in the capacity to which the rating relates; and such rating is deemed to form part of the licence.
- (8) Subject to any conditions of the licence and to the provisions of this Order, a licence of any class entitles the holder to perform the functions specified in that licence and a rating of any class entitles the holder of the licence in which such rating is included to perform the functions specified in that rating.

#### **Maintenance of privileges of aircraft ratings in licences**

**52.**—(1) The holder of a pilot’s licence or a flight engineer’s licence must not exercise the privileges of an aircraft rating contained in the licence on a flight unless the licence bears a valid certificate of test or a valid certificate of experience in respect of the rating.

(2) A certificate under paragraph (1) must be appropriate to the functions the holder is to perform on that flight in accordance with the requirements of the Governor and the holder must comply with those requirements.

(3) The holder of a Private Pilot’s Licence (Balloons and Airships) is entitled to exercise the privileges of an aircraft rating contained in the licence on a flight when the licence does not bear such a certificate.

(4) The holder of a Private Pilot’s Licence is not entitled to exercise the privileges of an aircraft rating contained in the licence on a flight unless the certificate of test or certificate of experience required by paragraph (1) is included in the personal flying log book required to be kept under article 58.

#### **Maintenance of privileges of other ratings in licences**

**53.** A person is not entitled to perform the functions to which an instrument rating (aeroplanes), an instrument rating (helicopters), or a flying instructor’s rating relates unless the person’s licence bears a valid certificate of test, which must be appropriate to the functions to which the rating relates, in accordance with the specified requirements and the person complies with those requirements.

#### **Medical requirements for licence holders**

**54.**—(1) The holder of a licence granted under article 51, other than a Flight Radiotelephony Operator’s Licence, must not perform any of the functions to which the licence relates unless it includes an appropriate valid medical certificate.



(2) Every applicant for or holder of a licence granted under article 51 must, upon such occasions as the Governor requires, submit to a medical examination by a person approved by the Governor, either generally or in a particular case or class of cases, who must make a report to the Governor in such form as the Governor requires.

(3) The Governor or any person approved by the Governor as competent to do so may issue a medical certificate to the effect that the holder of the licence meets the requirements specified in respect of the medical certificate.

(4) The certificate issued under paragraph (3) is valid for the period specified and is deemed to form part of the licence.

### **Licence holder not to act as member of flight crew when unfit**

**55.**—(1) A person must not act as a member of the flight crew of an aircraft registered in the Territory if they know or suspect that their physical or mental condition renders them temporarily or permanently unfit to perform such functions or to act in such capacity.

(2) Every holder of a medical certificate issued under article 54(3) who—

(i) suffers any personal injury involving any incapacity to undertake the holder's functions as a member of the flight crew;

(ii) suffers any illness involving any incapacity to undertake those functions throughout a period of 21 days or more; or

(iii) has reason to believe that she is pregnant,

must inform the Governor in writing of such injury, illness or pregnancy as soon as possible in the case of injury or pregnancy, and as soon as the period of 21 days has expired in the case of illness.

(3) The medical certificate is deemed to be suspended upon the occurrence of such injury or the expiry of such period of illness or the confirmation of the pregnancy.

(4) In the case of injury or illness the suspension ceases upon the holder being medically examined under arrangements made by the Governor and pronounced fit to resume functions as a member of the flight crew or upon the Governor exempting the holder from the requirement of a medical examination.

(5) In the case of pregnancy, the suspension may be lifted by the Governor upon the holder being medically examined under arrangements made by the Governor after the pregnancy has ended and pronounced fit to resume her functions as a member of the flight crew.

### **Miscellaneous licensing provisions**

**56.**—(1) The holder of a licence who, on the last occasion when the holder took a test for the purposes of articles 52 or 53, failed that test must not fly in the capacity for which that test would have qualified the holder had it been passed.

(2) Nothing in this Order shall prohibit the holder of a pilot's licence from acting as pilot of an aircraft certificated for single pilot operation when, with the permission of the Governor, the holder is testing any person for the purposes of articles 51(1), 51(5), 52 or 53, even if—

(a) the type of aircraft in which the test is conducted is not specified in an aircraft rating included in the licence; or

(b) the licence or personal flying log book, as the case may be, does not include a valid certificate of test, experience or revalidation for the type of aircraft.

(3) If the Governor so permits a test may be conducted in a synthetic training device approved by the Governor in accordance with the specified requirements.

(4) Without prejudice to any other provision of this Order the Governor may, for the purpose of this Part of this Order—

- (a) approve any course of training or instruction;
- (b) authorise a person to conduct such examinations or tests as may be specified; and
- (c) approve a person to provide any course of training or instruction.

### **Validation of licences**

57. The Governor may issue a certificate of validation rendering valid for the purposes of this Order any flight crew licence granted under the law of any country other than the Territory.

### **Personal flying logbook**

58.—(1) Every member of the flight crew of an aircraft registered in the Territory, and every person who engages in flying for the purpose of qualifying for the grant or renewal of a licence under this Order, must keep a personal flying logbook in which the following particulars must be recorded—

- (a) the name and address of the holder of the log book;
- (b) particulars of the holder's licence (if any) to act as a member of the flight crew of an aircraft; and
- (c) the name and address of the employer (if any).

(2) Particulars of each flight during which the holder of the log book acted either as a member of the flight crew of an aircraft or for the purpose of qualifying for the grant or renewal of a licence under this Order, as the case may be, must be recorded in the logbook at the end of each flight or as soon as reasonably practicable after the end of each flight.

(3) The particulars required under paragraph (2) are—

- (a) the date, the places at which the holder embarked on and disembarked from the aircraft and the time spent during the course of a flight when the holder was acting in either capacity;
- (b) the type and registration marks of the aircraft;
- (c) the capacity in which the holder acted in flight;
- (d) particulars of any special conditions under which the flight was conducted, including night flying and instrument flying; and
- (e) particulars of any test or examination undertaken whilst in flight.

(4) For the purposes of this article, a helicopter is deemed to be in flight from the moment the helicopter first moves under its own power for the purpose of taking off until the rotors are next stopped.

(5) Particulars of any test or examination undertaken whilst in a synthetic training device must be recorded in the logbook, including—

- (a) the date of the test or examination;
- (b) the type of synthetic training device;
- (c) the capacity in which the holder acted; and
- (d) the nature of the test or examination.

### **Instruction in flying**

59.—(1) This article applies to instruction in flying given to any person flying or about to fly an aircraft for the purpose of becoming qualified for—

- (a) the grant of a pilot's licence;
  - (b) the inclusion or variation of any rating in a licence.
- (2) The holder of a licence must not give any instruction in flying to which this article applies unless—
- (a) the licence granted or rendered valid under this Order entitles the holder to act as pilot-in-command of the aircraft for the purpose and in the circumstances under which the instruction is to be given; and
  - (b) the licence includes an instructor's rating entitling the holder to give the instruction.

#### **Glider pilot-minimum age**

- 60.** A person under the age of 16 years must not act as pilot-in-command of a glider.

## **PART 5**

### **PROTECTION OF CREW**

#### **Application and interpretation of Part 5**

**61.**—(1) Subject to paragraph (2), articles 62 and 63 apply to an aircraft registered in the Territory that is either—

- (a) flying on a commercial air transport flight;
- (b) operated by an air transport undertaking; or
- (c) operated by a person or organisation to which article 132 applies.

(2) Articles 62 and 63 do not apply to an aircraft in flight made only for the purpose of instruction in flying given by or on behalf of a flying club or flying school.

(3) In this Part—

- (a) “flight time”, in relation to any person, means all time spent by that person in—
  - (i) a civil aircraft whether or not registered in the Territory (other than an aircraft of which the maximum total weight authorised does not exceed 1600kg and which is not flying for the purpose of commercial air transport or aerial work); or
  - (ii) a military aircraft;while it is in flight and the person is carried as a member of the crew; and
- (b) a helicopter is deemed to be in flight from the moment the helicopter first moves under its own power for the purpose of taking off until the rotors are next stopped.

#### **Fatigue of crew - operator's responsibilities**

**62.**—(1) The operator of an aircraft to which this article applies must not cause or permit that aircraft to make a flight unless the operator has established a fatigue management scheme for the regulation of flight times, flight duty periods, duty periods and rest period limitations for every person flying in that aircraft as a member of its crew.

(2) Subject to paragraph (7), the scheme established under paragraph (1) must be approved by the Governor.

(3) The scheme established under paragraph (1) must—

- (a) be incorporated in the operations manual required by either article 96 or article 134; or

- (b) in any case where an operations manual is not required by either of those articles, be incorporated in a document a copy of which has been made available to every person flying in that aircraft as a member of its crew.
- (4) The operator must take all steps reasonably practicable to ensure that the provisions of the scheme will be complied with in relation to every person flying in that aircraft as a member of its crew.
- (5) The operator of an aircraft to which this article applies must not cause or permit any person to fly as a member of its crew if the operator knows or has reason to believe that the person is suffering from, or, having regard to the circumstances of the flight to be undertaken, is likely to suffer from, such fatigue whilst so flying as may endanger the safety of the aircraft or of its occupants.
- (6) The operator of an aircraft to which this article applies must not cause or permit any person to fly as a member of its flight crew unless the operator possesses an accurate and up to date record in respect of that person, and in respect of the 28 days immediately preceding the flight, showing—
  - (a) all the person's flight times, and
  - (b) brief particulars of the nature of the functions performed by the person in the course of the flight times.
- (7) Paragraph (2) does not apply to the operator of an aircraft registered in the Territory of any class, or which is used in any of the cases, identified in article 132(2).

#### **Fatigue of crew - responsibilities of crew**

**63.**—(1) Persons must not act as members of the crew of an aircraft to which this article applies if they know or suspect that they are suffering from, or, having regard to the circumstances of the flight to be undertaken, are likely to suffer from, such fatigue as may endanger the safety of the aircraft or of its occupants.

(2) A person must not act as a member of the flight crew of an aircraft to which this article applies without first ensuring that the operator of the aircraft is aware of that person's flight times during the period of 28 days preceding the flight.

#### **Flight times - responsibilities of flight crew**

**64.**—(1) Subject to paragraph (2), a person must not act as a member of the flight crew of an aircraft registered in the Territory if at the beginning of the flight the aggregate of all that person's previous flight times—

- (a) during the period of 28 consecutive days expiring at the end of the day on which the flight begins exceeds 100 hours; or
- (b) during the period of twelve months expiring at the end of the previous month exceeds 900 hours.

(2) This article does not apply to a flight that is a private flight in an aircraft of which the maximum total weight does not exceed 1600kg.

(3) This article does not apply to a private or aerial work flight, which is not operated by an air transport undertaking if, at the time when the flight begins, the aggregate of all the flight times of the member of the flight crew concerned since last being medically examined and found fit by a person approved by the Governor for the purpose of article 54(2) is not more than 25 hours.

#### **Protection of aircrew from cosmic radiation**

**65.**—(1) A relevant undertaking must take appropriate measures to—

- (a) assess the exposure to cosmic radiation when in flight of those air crew who are liable to be subject to cosmic radiation in excess of 1 milliSievert per year;
- (b) take into account the assessed exposure when organising work schedules with a view to reducing the doses experienced by highly exposed air crew; and
- (c) inform the workers concerned of the health risks their work involves.

(2) A relevant undertaking must ensure that in relation to a pregnant air crew member, the conditions of exposure to cosmic radiation when she is in flight are such that the equivalent dose to the foetus will be as low as reasonably achievable and is unlikely to exceed 1 milliSievert during the remainder of the pregnancy.

(3) Nothing in paragraph (2) requires the undertaking concerned to take any action in relation to an air crew member until she has notified the undertaking in writing that she is pregnant.

(4) The definition in article 3 of “crew” does not apply for the purposes of this article.

(5) In this article and in article 66—

- (a) “air crew” means every person employed or engaged in an aircraft in flight on the business of the aircraft;
- (b) “undertaking” includes a natural or legal person and “relevant undertaking” means an undertaking established in the Territory which operates aircraft;
- (c) “year” means any period of twelve months.

### **Keeping and production of records of exposure to cosmic radiation**

**66.**—(1) A relevant undertaking must keep a record for the period and in the manner specified by the Governor of the exposure to cosmic radiation of air crew assessed under article 65 and the names of the air crew concerned.

(2) A relevant undertaking must, within a reasonable period after being requested to do so by an authorised person, produce to that person the record required to be kept under paragraph (1).

(3) A relevant undertaking must, within a reasonable period after being requested to do so by a person, in respect of whom a record is required to be kept under paragraph (1), supply a copy of that record to that person.

## **PART 6**

### **AIRCRAFT IN FLIGHT**

#### **Rules of the Air**

**67.**—(1) The Governor may, by regulation, make Rules of the Air supplementary to but not inconsistent with the Rules of the Air in Schedule 4.

(2) It is an offence to contravene, to permit the contravention of, or to fail to comply with, the Rules of the Air.

(3) It is lawful to depart from the Rules of the Air to the extent necessary—

- (a) for avoiding immediate danger;
- (b) for complying with the law of any country other than the Territory within which the aircraft then is;
- (c) for complying with Military Flying Regulations or Flying Orders to Contractors issued by the Secretary of State in relation to an aircraft of which the pilot-in-command is acting in the course of his duty as a member of any of Her Majesty’s naval, military or air forces.

(4) If any departure from the Rules of the Air is made for the purpose of avoiding immediate danger, the pilot-in-command of the aircraft must cause written particulars of the departure, and of the circumstances giving rise to it, to be given to the competent authority of the country in whose territory the departure was made or, if the departure was made over the high seas, to the Governor.

(5) Nothing in the Rules of the Air exonerates any person from the consequences of any neglect in the use of lights or signals or of the neglect of any precautions required by ordinary aviation practice or by the special circumstances of the case.

### **Power to prohibit or restrict flying**

**68.**—(1) Where the Governor decides it is necessary in the public interest to restrict or prohibit flying by reason of—

- (a) the intended gathering or movement of a large number of persons;
- (b) the intended holding of an aircraft race or contest or of a flying display; or
- (c) national defence or any other reason affecting the public interest;

the Governor may issue directions prohibiting, restricting or imposing conditions on flights by aircraft specified and flying in the circumstances specified in paragraph (2).

(2) The aircraft and circumstances referred to in paragraph (1) are—

- (a) aircraft, whether or not registered in the Territory, in any airspace over the Territory or in the neighbourhood of an offshore installation; and
- (b) aircraft registered in the Territory in any other airspace, being airspace in respect of which the Government of the Territory has, under international arrangements, undertaken to provide navigation services for aircraft.

(3) Directions given under this article may apply either generally or in relation to any class of aircraft.

(4) It is an offence to contravene, or permit the contravention of, or fail to comply with, any directions given under this article.

(5) If the pilot-in-command of an aircraft becomes aware that the aircraft is flying in contravention of any directions which have been given for any of the reasons referred to in paragraph (1)(c) the pilot-in-command must, unless otherwise instructed under paragraph (6), cause the aircraft to leave the area to which the directions relate by flying to the least possible extent over such area and the aircraft must not begin to descend while over such an area.

(6) The pilot-in-command of an aircraft flying either within an area for which directions have been given for any of the reasons referred to in paragraph (1)(c) or within airspace notified as a Danger Area must immediately comply with instructions given by radio by the appropriate air traffic control unit or by, or on behalf of, the person responsible for safety within the relevant airspace.

### **Flying Displays**

**69.**—(1) Except as provided in paragraph (12) and (14), no person may act as the organiser of a flying display (in this article referred to as ‘the flying display director’) without first obtaining the permission of the Governor for that flying display.

(2) The pilot-in-command of an aircraft who is intending to participate in a flying display must be satisfied before participating that—

- (a) the flying display director has been granted an appropriate permission under paragraph (6);
- (b) the flight can comply with any relevant conditions subject to which that permission may have been granted; and
- (c) the pilot has been granted an appropriate pilot display authorisation.

(3) The pilot-in-command who is participating in a flying display for which permission has been granted must comply with any conditions subject to which that permission may have been granted.

(4) A person acting as pilot of an aircraft participating in a flying display must hold an appropriate pilot display authorisation and comply with any conditions subject to which the authorisation may have been given.

(5) A flying display director must not permit any person to act as pilot of an aircraft that participates in a flying display unless that person holds an appropriate pilot display authorisation.

(6) The Governor must grant a permission required by paragraph (1) upon being satisfied that the applicant is fit and competent to organise safely the proposed flying display, having regard in particular to the applicant's—

- (a) previous conduct and experience;
- (b) organisation, staffing and other arrangements.

(7) The Governor may grant a permission subject to conditions in respect of military aircraft as the Governor thinks fit.

(8) The Governor must, for the purposes of this article, grant a pilot display authorisation authorising the holder to act as pilot of an aircraft taking part in a flying display upon being satisfied that the applicant is—

- (a) a fit person to hold the authorisation; and
- (b) is qualified by having the knowledge, experience, competence, skill, physical and mental fitness to fly in accordance with the authorisation.

(9) For the purposes of paragraph (8) the applicant must supply such evidence and undergo such examinations and tests as the Governor may require.

(10) The Governor may authorise a person to conduct such examinations or tests as may be specified.

(11) For the purposes of this article, an appropriate pilot display authorisation means an authorisation which is valid and appropriate to the intended flight and which has been granted by the Governor under paragraph (8).

(12) Paragraph (1) does not apply to—

- (a) a flying display which takes place at a military aerodrome; or
- (b) a flying display at which the only participating aircraft are military aircraft.

(13) A flying display director must not permit any military aircraft to participate in a flying display unless the director complies with any conditions concerning military aircraft subject to which permission for the flying display may have been granted.

(14) Nothing in this article applies to an aircraft race or contest or to an aircraft taking part in such a race or contest or to the pilot-in-command or pilot whether or not such race or contest is held in association with a flying display.

## **Balloons**

**70.**—(1) This article applies to balloons within the Territory.

(2) A balloon in captive or tethered flight must not be flown without the permission in writing of the Governor.

(3) An uncontrollable balloon in released flight must not be flown in airspace notified for the purposes of this paragraph without the permission in writing of the Governor.

(4) Except during the day and in visual meteorological conditions a controllable balloon must not be flown in free controlled flight—

- (a) within airspace notified for the purposes of this paragraph; or
- (b) within the aerodrome traffic zone of an aerodrome during the notified operating hours of that aerodrome.

(5) A balloon when in captive flight must be securely moored and must not be left unattended unless it is fitted with a device which ensures its automatic deflation if it breaks free of its moorings.

(6) Except with the permission of the Governor, and in accordance with its conditions, a person must not cause or permit a group of small balloons exceeding 1000 in number to be simultaneously released at a single site.

(7) For the purposes of this article ‘simultaneously released at a single site’ means the release of a specified number of balloons during a period not exceeding 15 minutes from within an area not exceeding 1 square km.

### **Glinters, kites and parascending parachutes**

**71.**—(1) This article applies to gliders, kites and parascending parachutes within the Territory.

(2) Except with the permission of the Governor—

- (a) a glider or parascending parachute must not be launched by winch and cable or by ground tow to a height of more than 60 metres above ground level;
- (b) a kite must not be flown at a height of more than 30 metres above ground level within the aerodrome traffic zone of an aerodrome during the notified operating hours of that aerodrome;
- (c) a kite must not be flown at a height of more than 60 metres above ground level; and
- (d) a parascending parachute must not be launched by winch and cable or by ground tow within the aerodrome traffic zone of an aerodrome during the notified operating hours of that aerodrome.

### **Airships**

**72.**—(1) This article applies to airships within the Territory.

(2) An airship with a capacity exceeding 3000 cubic metres must not be moored other than at an aerodrome except with the permission in writing of the Governor.

(3) Except with the permission in writing of the Governor an airship with a capacity not exceeding 3000 cubic metres, unless it is moored on an aerodrome, must not be moored—

- (a) within 2 km of a congested area; or
- (b) within the aerodrome traffic zone of an aerodrome.

(4) An airship when moored in the open must be securely moored and must not be left unattended.

### **Regulation of small unmanned aircraft**

**73.**—(1) A person must not cause or permit any article or animal (whether or not attached to a parachute) to be dropped from a small unmanned aircraft so as to endanger persons or property.

(2) The person in charge of a small unmanned aircraft may only fly the aircraft if reasonably satisfied that the flight can safely be made.

(3) The person in charge of a small unmanned aircraft must maintain direct, unaided visual contact with the aircraft sufficient to monitor its flight path in relation to other aircraft, persons, vehicles, vessels and structures for the purpose of avoiding collisions.



(4) The person in charge of a small unmanned aircraft which has a mass of more than 7kg, excluding its fuel but including any articles or equipment installed in or attached to the aircraft at the commencement of its flight, must not fly the aircraft—

- (a) in Class A, C, D or E airspace unless the permission of the appropriate air traffic control unit has been obtained;
- (b) within an aerodrome traffic zone during the notified hours of watch of the air traffic control unit (if any) at that aerodrome unless the permission of any such air traffic control unit has been obtained; or
- (c) at a height of more than 400 feet above the surface unless it is flying in airspace described in sub-paragraph (a) or (b) and in accordance with the requirements for that airspace.

(5) The person in charge of a small unmanned aircraft must not fly the aircraft for the purposes of aerial work except in accordance with a permission granted by the Governor.

(6) The person in charge of a small unmanned surveillance aircraft must not fly the aircraft in any of the circumstances described in paragraph (7) except in accordance with a permission issued by the Governor.

(7) The circumstances referred to in paragraph (6) are—

- (a) over or within 150 metres of any congested area;
- (b) over or within 150 metres of an organised open-air assembly of more than 1,000 persons;
- (c) within 50 metres of any vessel, vehicle or structure which is not under the control of the person in charge of the aircraft; or
- (d) subject to paragraphs (8) and (9), within 50 metres of any person.

(8) Subject to paragraph (9), during take-off or landing, a small unmanned surveillance aircraft must not be flown within 30 metres of any person.

(9) Paragraphs (7)(d) and (8) do not apply to the person in charge of the small unmanned surveillance aircraft or a person under the control of the person in charge of the aircraft.

(10) In this article “a small unmanned surveillance aircraft” means a small unmanned aircraft that is equipped to undertake any form of surveillance or data acquisition.

## PART 7

### OPERATION OF AIRCRAFT

#### Operation of aircraft

74.—(1) A person must not operate an aircraft registered in the Territory, or an aircraft registered elsewhere than in the Territory in or over the Territory, unless that person complies with—

- (a) the operating limitations specified in the aircraft flight manual or equivalent document, except as provided in paragraph (4);
- (b) the Rules of the Air and any supplemental Rules of the Air made by the Governor under article 67(1);
- (c) any instructions given or published by the Governor for the operation and safety of aircraft and the safety of persons and property carried in an aircraft including instructions in respect of the instruments and equipment to be installed in or carried on an aircraft.

(2) Subject to article 156, an aircraft must not take off or land at any place unless—

- (a) the aerodrome or operating site is satisfactory, taking account of the physical characteristics of the place, the operating environment and the performance of the aircraft; and
- (b) for operations at an aerodrome, at the expected time of use the aerodrome will be available and equipped with necessary ancillary services.

(3) For the purposes of this article “ancillary services” means some or all of air traffic services, lighting, communications, weather reporting, navigation aids and emergency services, as appropriate to the circumstances.

(4) An aircraft flying clear of cloud and with the surface in sight is, for the purposes of paragraph (1)(a), deemed to be flying in accordance with the Visual Flight Rules.

### **Non-commercial air transport aircraft – aerodrome operating minima**

**75.**—(1) This article applies to any aircraft that is not operating for the purposes of commercial air transport.

(2) Except under and in accordance with the terms of an approval to do so, an aircraft to which this article applies must not conduct—

- (a) a Category II operation; or
- (b) an Other than Standard Category II operation; or
- (c) an approach and landing using minima lower than those for a Category II operation;

unless, under the law of the country in which it is registered, the aircraft is certificated for operations with decision heights below 200 feet, or no decision height, and is equipped for such operations.

(3) Except under and in accordance with the terms of an approval to do so, granted in accordance with the law of the country in which it is registered, an aircraft to which this article applies must not—

- (a) take off when the relevant runway visual range is less than the specified runway visual range; or
- (b) conduct an approach and landing when the visibility or relevant runway visual range is less than that specified for a Category I operation.

(4) In the case of an aircraft registered in the Territory, an approval referred to in paragraphs (2) and (3) is one issued by the Governor.

(5) Without prejudice to the provisions of paragraph (2) an aircraft to which this article applies, when making a descent at an aerodrome, must not descend from a height of 1000 feet or more above the aerodrome to a height less than 1000 feet above the aerodrome if the reported visibility or relevant runway visual range at the aerodrome is at the time less than the specified minimum for landing.

(6) Without prejudice to the provisions of paragraph (2) an aircraft to which this article applies when making a descent to a runway in respect of which there is a notified instrument approach procedure must not—

- (a) continue an approach to landing at such a runway by flying below the relevant specified decision height; or
- (b) descend below the relevant specified minimum descent height;

unless in either case from such height the specified visual reference for landing is established and is maintained.

(7) If, according to the information available, an aircraft would, as regards any flight, be required by any of rules 18(1), 19(1) or 20 of the Rules of the Air to be flown in accordance with the Instrument Flight Rules at the aerodrome of intended landing, the pilot-in-command of the aircraft must select prior to take-off an alternative aerodrome, unless no aerodrome suitable for that purpose is available.

(8) A flight to be conducted in accordance with the Instrument Flight Rules to an aerodrome when no alternate aerodrome is available must not be commenced unless—

- (a) a designated instrument approach procedure is available for the aerodrome of intended landing; and
- (b) the available current meteorological information indicates that visual meteorological conditions will exist at the aerodrome of intended landing from two hours before to two hours after the estimated time of arrival.

(9) A flight must not be continued towards the aerodrome of intended landing unless the latest available information indicates that conditions at that aerodrome, or at least one alternate aerodrome, will, at the estimated time of arrival, be at or above the specified aerodrome operating minima.

(10) In this article “specified” in relation to aerodrome operating minima means the particulars of aerodrome operating minima notified in respect of the aerodrome or if the relevant minima have not been notified such minima as are ascertainable by reference to the notified method for calculating the aerodrome operating minima.

(11) In this article “Category I operation”, “Category II operation” and “Other than Standard Category II operation” have the same meaning as in article 105(9).

(12) In this article “designated” in relation to an instrument approach procedure means notified, prescribed or otherwise designated by the relevant competent authority.

#### **Pilot to remain at controls**

**76.**—(1) The pilot-in-command of a flying machine registered in the Territory must ensure that one pilot remains at the controls at all times while it is in flight.

(2) If the aircraft is required by or under this Order to carry two pilots, the pilot-in-command must ensure that both pilots remain at the controls during take-off and landing.

(3) If the aircraft carries two or more pilots (whether or not it is required to do so) and is engaged on a flight for the purpose of the commercial air transport of passengers, the pilot-in-command must remain at the controls during take-off and landing.

(4) An operator must not permit a helicopter rotor to be turned under power for the purpose of making a flight unless there is a person at the controls entitled in accordance with article 44 to act as pilot-in-command of the helicopter.

(5) Each pilot at the controls must be secured in his seat by either a safety belt with or without one diagonal shoulder strap, or a safety harness, except that during take-off and landing a safety harness must be worn if it is required by article 35 to be provided.

#### **Wearing of survival suits by crew**

**77.** Each member of the crew of an aircraft registered in the Territory must wear a survival suit if the specified requirements demand that such a suit is to be worn.

#### **Pre-flight action by pilot-in-command of an aircraft**

**78.** The pilot-in-command of an aircraft must take all reasonable steps so as to be satisfied before the aircraft takes off—

- (a) that the flight can safely be made, taking into account the latest information available as to the route and aerodrome to be used, the weather reports and forecasts available and any alternative course of action which can be adopted in case the flight cannot be completed as planned;
- (b) either—

- (i) that the equipment (including radio equipment) required by or under this Order to be carried in the circumstances of the intended flight is carried and is in a fit condition for use; or
- (ii) that the flight may commence under and in accordance with the terms of an approval granted to the operator under article 37;
- (c) that the aircraft is in every way fit for the intended flight;
- (d) that the load carried by the aircraft is of such weight, and is so distributed and secured, that it may safely be carried on the intended flight;
- (e) that sufficient fuel, oil and engine coolant (if required) are carried for the intended flight, and that a safe margin has been allowed for contingencies;
- (f) in the case of an airship or balloon, that sufficient ballast is carried for the intended flight; and
- (g) that, having regard to its performance in the conditions to be expected on the intended flight and to any obstructions at the places of departure and intended destination and on the intended route, it is capable of safely taking off, reaching and maintaining a safe height and making a safe landing at the place of intended destination.

#### **Passenger briefing by pilot-in-command**

**79.** The pilot-in-command of an aircraft registered in the Territory must take all reasonable steps to ensure—

- (a) before the aircraft takes off on any flight, that all passengers are made familiar with the position and method of use of emergency exits, safety belts, safety harnesses and oxygen equipment, lifejackets and the floor path lighting system and all other devices required by or under this Order and intended for use by passengers individually in the case of an emergency occurring to the aircraft; and
- (b) that in an emergency during a flight, all passengers are instructed in the emergency action which they should take.

#### **Survival equipment - non-commercial air transport flights**

**80.**—(1) This article applies to any aircraft registered in the Territory that is flying for a purpose other than commercial air transport.

(2) The pilot-in-command of an aircraft to which this article applies must be satisfied on reasonable grounds before take-off that the aircraft carries such additional equipment as the pilot-in-command reasonably considers necessary for the purpose of facilitating the survival of the persons carried in the aircraft.

(3) In complying with paragraph (2), the pilot-in-command must have regard to the circumstances of the intended flight, including in particular the likelihood of ditching and the availability of search and rescue facilities.

#### **Use of oxygen - non-commercial air transport flights**

**81.**—(1) This article applies to any aircraft registered in the Territory that is flying for any purpose other than commercial air transport.

(2) Except where the cabin pressure altitude does not exceed 10,000 feet during the flight, on every flight to which this article applies the pilot-in-command of the aircraft must take all reasonable steps to ensure that—

- (a) before the aircraft reaches flight level 130 the method of use of the oxygen provided in the aircraft in compliance with the requirements of article 35 is demonstrated to all passengers;
- (b) when flying above flight level 130 all passengers and crew members are instructed to use oxygen;
- (c) during any period when the aircraft is flying above flight level 100 up to and including flight level 130 oxygen is used by all the flight crew of the aircraft for any part of the flight between those altitudes that is of more than 30 minutes duration; and
- (d) during any period when the aircraft is flying above flight level 130 oxygen is used continuously by all the flight crew of the aircraft.

### **Operation of radio in aircraft**

**82.**—(1) A radio station in an aircraft must not be operated, whether or not the aircraft is in flight, except in accordance with the conditions of the licence issued for that radio station under the law of the country in which the aircraft is registered or the State of the operator and by a person duly licensed or otherwise permitted to operate the radio station under that law.

(2) Whenever an aircraft is in flight in such circumstances that it is required by or under this Order to be equipped with radio communication equipment, a continuous radio watch must be maintained by a member of the flight crew listening to the signals transmitted on the frequency notified or designated for use by that aircraft by a message received from an appropriate aeronautical radio station.

(3) The radio watch referred to in paragraph (2)—

- (a) may be discontinued or continued on another frequency if a message from an appropriate aeronautical radio station permits this; or
- (b) may be kept by a device installed in the aircraft if—
  - (i) the appropriate aeronautical radio station has been informed to that effect and has raised no objection; and
  - (ii) that station is notified or, in the case of a station situated in a country other than the Territory, otherwise designated as transmitting a signal suitable for that purpose.

(4) Whenever an aircraft is in flight in such circumstances that it is required by or under this Order to be equipped with radio or radio navigation equipment, a member of the flight crew must operate that equipment in such a manner as instructed by the appropriate air traffic control unit or as may be notified in relation to any notified airspace in which the aircraft is flying.

(5) The radio station in an aircraft must not be operated so as to cause interference with, or impair the efficiency of, aeronautical telecommunications or navigational services, and in particular emissions must not be made except as follows—

- (a) emissions of the class and frequency for the time being in use, in accordance with general international aeronautical practice, in the airspace in which the aircraft is flying;
- (b) distress, urgency and safety messages and signals, in accordance with general international aeronautical practice;
- (c) messages and signals relating to the flight of the aircraft, in accordance with general international aeronautical practice; and
- (d) such public correspondence messages as may be permitted by or under the aircraft radio station licence referred to in paragraph (1).

(6) In any aircraft operating under instrument flight rules and in any flying machine registered in the Territory which is engaged on a flight for the purpose of commercial air transport, those flight crew members required to be on flight deck duty must not make use of a hand-held microphone

(whether for the purpose of radio communication or of intercommunications within the aircraft) when below the transition altitude.

#### **Use of airborne collision avoidance system**

**83.** On any flight on which an airborne collision avoidance system is required to be carried in an aeroplane in accordance with article 35, the system must be operated—

- (a) in the case of an aircraft to which article 96 applies, in accordance with procedures contained in the operations manual for the aircraft;
- (b) in the case of an aircraft registered in the Territory to which article 96 does not apply, in accordance with procedures which are suitable having regard to the purposes of the equipment; or
- (c) in the case of an aircraft which is registered elsewhere than in the Territory, in accordance with any procedures with which it is required to comply under the law of the country in which the aircraft is registered.

#### **Use of flight recording systems and preservation of records**

**84.—(1)** On any flight on which a flight recorder is required to be carried in an aeroplane in accordance with article 35, it must be operated continuously from the time the first engine is started for the purpose of making a flight until the time the last engine is shut down after landing.

(2) On any flight on which a flight recorder is required under article 35 to be carried in a helicopter, it must be operated continuously from the time the rotors first turn for the purpose of making a flight until the rotors are next stopped.

(3) In the event of an incident or accident the pilot-in-command and the operator of the aircraft must ensure that flight recorders are de-activated and must, subject to article 171, preserve the flight recorder and records in accordance with such requirements as the Governor may prescribe or as the Governor directs.

(4) The operator of the aircraft must ensure that operational checks and evaluations of recordings from the flight data recorder and cockpit voice recorder systems are conducted in accordance with the specified requirements, to ensure the continued serviceability of the recorders.

#### **Duties of pilot-in-command – search and rescue**

**85.** Without prejudice to any other provision of this Order, the pilot-in-command of an aircraft that is either registered in the Territory or, if not so registered, is flying within the Territory airspace shall cooperate in fulfilling the instructions of the Governor in relation to the provision of assistance to aircraft in distress or in relation to search and rescue.

#### **Method of carriage of persons**

**86.—(1)** A person must not—

- (a) be in or on any part of an aircraft in flight which is not a part designed for the accommodation of persons and in particular a person must not be on the wings or undercarriage of an aircraft; or
- (b) be in or on any object, other than a glider or flying machine, towed by or attached to an aircraft in flight.

(2) A person may have temporary access to—

- (a) any part of an aircraft for the purpose of taking action necessary for the safety of the aircraft or of any person, animal or goods in it; and

- (b) any part of an aircraft in which cargo or stores are carried, being a part which is designed to enable a person to have access thereto while the aircraft is in flight.

### **Exits – commercial air transport aircraft**

**87.**—(1) This article applies to every Territory registered commercial air transport aeroplane or helicopter.

(2) Subject to paragraph (10), whenever an aeroplane or helicopter to which this article applies is carrying passengers, every exit and every internal door in the aeroplane or helicopter must be in working order.

(3) Subject to paragraph (4) during take-off and landing and during any emergency, every exit and door must be kept free of obstruction and must not be fastened by locking or otherwise so as to prevent, hinder or delay its use by passengers.

(4) In the case of—

- (a) an exit which, in accordance with arrangements approved by the Governor either generally or in relation to a class of aeroplane or helicopter or a particular aeroplane or helicopter, is not required for use by passengers, the exit may be obstructed by cargo;
- (b) a door between the flight crew compartment and any adjacent compartment to which passengers have access, the door may be locked or bolted if the pilot-in-command of the aeroplane or helicopter so determines, for the purpose of preventing access by passengers to the flight crew compartment;
- (c) an internal door which is so placed that it cannot prevent, hinder or delay the exit of passengers from the aeroplane or helicopter in an emergency if it is not in working order, paragraph (3) does not apply.

(5) Every exit from an aeroplane or helicopter must be marked on interior surfaces with the words “exit” or “emergency exit” in capital letters, which must be red in colour and if necessary outlined in white to contrast with the background.

(6) Every exit from an aeroplane or helicopter must be marked on exterior surfaces with the words “exit” or “emergency exit” in capital letters, which must be located on a background that provides adequate contrast.

(7) Every exit from an aeroplane or helicopter must be marked on interior surfaces on or near the inside surface of the door or other closure of the exit with instructions in English and with diagrams to indicate the correct method of opening the exit, which must be red in colour and located on a background which provides adequate contrast.

(8) Every exit from the aeroplane or helicopter which may be opened from the outside must be marked on or near the exterior surface of the door or other closure of the exit with instructions in English and with diagrams to indicate the correct method of opening the exit which must be located on a background which provides adequate contrast.

(9) The markings required by this article must be—

- (a) painted, or fixed by other equally permanent means; and
- (b) kept clean and un-obscured at all times.

(10) Subject to compliance with paragraph (11), if one, but not more than one, exit from an aeroplane or helicopter becomes inoperative at a place where it is not reasonably practicable for it to be repaired or replaced, nothing in this article prevents that aeroplane or helicopter from carrying passengers until it next lands at a place where the exit can be repaired or replaced.

(11) Paragraph 10 is complied with if—

- (a) the number of passengers carried and the position of the seats which they occupy are in accordance with arrangements approved by the Governor either in relation to the particular aeroplane or helicopter or to a class of aeroplane or helicopter; and
- (b) in accordance with arrangements so approved, the inoperative exit is fastened by locking or otherwise, the words “Exit” or “Emergency Exit” are covered, and the exit is marked by a red disc at least 23 centimetres in diameter with a horizontal white bar across it bearing the words “No Exit” in red letters.

### **Marking of break-in areas**

**88.**—(1) This article applies to all aircraft registered in the Territory.

(2) An operator must ensure that, if areas of the fuselage suitable for break-in by rescue crews in emergency are marked on aircraft to which this article applies, such areas are marked upon the exterior surface of the fuselage with markings to show the areas (in this article referred to as “break-in areas”) which can, for purposes of rescue in an emergency, be most readily and effectively broken into by persons outside the aircraft.

(3) The break-in areas must be marked in accordance with the specified requirements.

## **PART 8**

### **HEIGHT KEEPING AND NAVIGATION**

#### **Area navigation and required navigation performance capabilities – aircraft registered in the Territory**

**89.**—(1) An aircraft registered in the Territory must not fly in areas with specified performance based navigation unless—

- (a) it is equipped with navigation equipment that complies with such requirements published, and instructions given, by the Governor under articles 5 and 74 of this Order;
  - (b) the operator has been approved by the Governor; and
  - (c) while the aircraft is flying in such airspace, on such routes or in accordance with such procedures, it is operated in accordance with operating procedures approved by the Governor.
- (2) An aircraft need not comply with the requirements of paragraph (1) if—
- (a) the flight has been authorised by the appropriate air traffic control unit;
  - (b) the air traffic control unit is made aware of the lack of compliance of the aircraft with such requirements; and
  - (c) the aircraft complies with any instructions the air traffic control unit may give in the particular case.

(3) For the purposes of this article and article 90, “areas with specified performance based navigation” means airspace, routes or procedures which have been notified, prescribed or otherwise designated by the competent authority for the airspace as requiring specified navigation performance capabilities to be met by aircraft flying there.

#### **Area navigation and required navigation performance capabilities – aircraft not registered in the Territory**

**90.**—(1) An aircraft registered elsewhere than in the Territory must not fly in areas with specified performance based navigation in the Territory unless—



- (a) it is equipped with navigation equipment so as to comply with the law of the country in which the aircraft is registered insofar as that law requires it to be so equipped when flying in areas with specified performance based navigation; and
- (b) the said equipment is capable of being operated so as to enable the aircraft to meet the required performance in terms of navigation functionality, accuracy, integrity, availability and continuity, and it is so operated.

(2) An aircraft need not comply with the requirements of paragraph (1) where the flight has been authorised by the appropriate air traffic control unit notwithstanding the lack of compliance and provided that the aircraft complies with any instructions the air traffic control unit may give in the particular case.

### **Minimum navigation performance**

**91.**—(1) An aircraft registered in the Territory must not fly in minimum navigation performance specifications airspace unless—

- (a) it is equipped with navigation equipment that complies with such requirements as are published and instructions given by the Governor under articles 5 and 74 of this Order;
- (b) the operator has been approved by the Governor; and
- (c) while the aircraft is flying in the said airspace, it is operated in accordance with operating procedures approved by the Governor.

(2) For the purposes of this article “minimum navigation performance specifications airspace” means airspace which has been notified, prescribed or otherwise designated as such by the competent authority for the airspace.

### **Height keeping performance - aircraft registered in the Territory**

**92.**—(1) An aircraft registered in the Territory must not fly in reduced vertical separation minimum airspace unless—

- (a) the aircraft has been approved by the Governor for operations in such airspace;
- (b) the operator has been approved by the Governor; and
- (c) while the aircraft is flying in the airspace, it is operated in accordance with operating procedures approved by the Governor.

(2) An aircraft need not comply with the requirements of paragraph (1) where the flight has been authorised by the appropriate air traffic control unit notwithstanding the lack of compliance and provided that the aircraft complies with any instructions the air traffic control unit may give in the particular case.

(3) For the purposes of this article and article 93, “reduced vertical separation minimum airspace” means airspace which has been notified, prescribed or otherwise designated as such by the competent authority for the airspace and where a reduced vertical separation minimum of 1000 feet (300 m) applies above flight level 290.

### **Height keeping performance - aircraft not registered in the Territory**

**93.**—(1) An aircraft registered elsewhere than in the Territory must not fly in notified reduced vertical separation minimum airspace in the Territory unless—

- (a) it is equipped with height keeping systems so as to comply with the law of the country in which the aircraft is registered insofar as that law requires it to be so equipped when flying in any specified areas; and

(b) the said equipment is capable of being operated so as to enable the aircraft to maintain the height keeping performance prescribed in respect of the airspace in which the aircraft is flying, and it is so operated.

(2) An aircraft need not comply with the requirements of paragraph (1) where the flight has been authorised by the appropriate air traffic control unit notwithstanding the lack of compliance and provided that the aircraft complies with any instructions the air traffic control unit may give in the particular case.

## PART 9

### AIR OPERATOR CERTIFICATION

#### Issue of air operator's certificate

94.—(1) An aircraft registered in the Territory must not fly on any flight for the purpose of commercial air transport except under and in accordance with the terms of an air operator's certificate granted to the operator of the aircraft under paragraph (2), certifying that the holder of the certificate is competent to secure that aircraft operated by the holder on such flights are operated safely.

(2) The Governor must grant an air operator's certificate to an operator, having its principal place of business in the Territory, upon being satisfied that the applicant is competent to secure the safe operation of aircraft of the types specified in the certificate on flights of the description and for the purposes specified, having regard in particular to the applicant's—

- (a) previous conduct and experience;
- (b) equipment;
- (c) organisation and staffing; and
- (d) maintenance and other arrangements.

(3) The operator of an aircraft to which this article applies must establish and maintain to the satisfaction of the Governor a safety management system appropriate to the size and complexity of the operation.

(4) For the purposes of this article “principal place of business” means the primary location from which flight operations and maintenance management and control are exercised; where the majority of the operational and safety-related records are kept and at which accountable managers are based.

(5) A person must not hold himself or herself, or any other person, out as being a person who may offer flights on an aircraft registered in the Territory for the purpose of commercial air transport unless the person, or that other person (as the case may be), holds a valid air operator's certificate granted under this article.

#### Police air operations

95.—(1) A flight by an aircraft in the service of a police authority for the Territory is, for the purposes of this Order, deemed to be a commercial air transport flight.

(2) If any passenger is carried on such a flight it is deemed to be for the purpose of commercial air transport of passengers.

(3) Save as otherwise expressly provided, the provisions of this Order and of any regulations made under this Order must be complied with in relation to a flight in the service of a police authority as if that flight were for the purpose of commercial air transport.

(4) An aircraft registered in the Territory must not fly on any flight in the service of the police authority otherwise than under and in accordance with either the terms of an air operator's certificate

granted to the operator under article 94(2) or a police air operator's certificate granted to the operator under paragraph (5).

(5) The Governor must grant a police air operator's certificate upon being satisfied that the applicant is competent to secure that the operation of aircraft of the types specified in the certificate will be as safe as is appropriate when flying on flights of the description and for the purposes specified, having regard in particular to the applicant's—

- (a) previous conduct and experience;
- (b) equipment;
- (c) organisation and staffing; and
- (d) maintenance and other arrangements.

### **Operations manual**

**96.**—(1) This article applies to commercial air transport aircraft registered in the Territory except aircraft used for the time being solely for flights not intended to exceed 60 minutes in duration, which are flights solely for training persons to perform duties in an aircraft.

- (2) An operator of an aircraft to which this article applies must—
  - (a) make available to each member of the operating staff an operations manual, acceptable to the Governor, which complies with paragraph (3);
  - (b) ensure that each copy of the operations manual is kept up to date; and
  - (c) ensure that on each flight every member of the crew has access to a copy of every part of the operations manual which is relevant to the crew member's duties on the flight.
- (3) An operations manual—
  - (a) complies with this paragraph if, subject to sub-paragraph (b), it contains all information and instructions necessary to enable the operating staff to perform their duties as such, including, in particular, information and instructions relating to the specified requirements;
  - (b) is not required to contain any information or instructions available in a flight manual accessible to the persons by whom the information or instructions may be required.

(4) An aircraft to which this article applies must not fly unless, at least 30 days prior to such flight, the operator of the aircraft has supplied to the Governor a copy of the whole of the operations manual in effect for the aircraft.

(5) Any amendments or additions to the operations manual must be supplied to the Governor by the operator before or immediately after they come into effect.

(6) If an amendment or addition relates to the operation of an aircraft to which the operations manual did not previously apply, that aircraft must not fly for the purpose of commercial air transport until the amendment or addition has been supplied to the Governor.

(7) The operator must make such amendments or additions to the operations manual as the Governor may require for the purpose of ensuring the safety of the aircraft, or of persons or property carried in it, or for the safety or efficiency of air navigation.

### **Training programme**

**97.**—(1) The operator of every aircraft registered in the Territory and flying for the purpose of commercial air transport must—

- (a) establish a ground and flight training programme, approved by the Governor, to ensure that flight and cabin crew members are adequately trained and competent to perform their duties; and

- (b) ensure that the details of the approved training programme are incorporated into the operations manual required by article 96.
- (2) This article does not apply to aircraft flying, or intended by the operator of the aircraft to fly, solely under and in accordance with the terms of a police air operator's certificate.
- (3) The operator must make such amendments or additions to the training programme as the Governor may require for the purpose of ensuring the safety of the aircraft, or of persons or property carried in it, or for the safety of air navigation.

### **Flight data monitoring**

- 98.**—(1) This article applies to any aircraft registered in the Territory and flying for the purpose of commercial air transport.
- (2) The operator of an aeroplane with a maximum certificated take-off mass of more than 20,000kg must include a flight data monitoring programme as part of its safety management system.
  - (3) The operator of a helicopter with a maximum certificated take-off mass of more than 7,000kg, or having a maximum approved passenger seating configuration of more than 9, must include a flight data monitoring programme as part of its safety management system.
  - (4) The sole objective of a flight data monitoring programme is the prevention of accidents and incidents and each programme must be designed and managed to meet that objective.
  - (5) It is not the purpose of a flight data monitoring programme to establish blame or liability.

## **PART 10**

### **COMMERCIAL AIR TRANSPORT OPERATIONS**

#### **Operator's responsibilities**

- 99.**—(1) The operator of an aircraft registered in the Territory must not permit an aircraft to fly for the purpose of commercial air transport without first—
- (a) designating from among the flight crew a pilot to be the pilot-in-command of the aircraft for the flight;
  - (b) being satisfied by every reasonable means that the aeronautical radio stations and navigational aids serving the intended route or any planned diversion are adequate for the safe navigation of the aircraft; and
  - (c) ensuring that, for a helicopter flying at night, adequate lighting is in operation at any operating site where it is intended to take off or land.
- (2) The operator of an aircraft registered in the Territory must not permit any person to be a member of the crew during any flight for the purpose of commercial air transport (except a flight for the sole purpose of training persons to perform duties in aircraft) unless—
- (a) such person has had the training, experience, practice and periodical tests specified by the Governor in respect of the duties to be performed; and
  - (b) the operator is satisfied that such person is competent to perform those duties, and in particular to use the equipment provided in the aircraft for that purpose.
- (3) The operator must maintain, preserve, produce and provide information in respect of records relating to the matters specified in paragraph (2) in accordance with the specified requirements.
- (4) During any flight for the purpose of the commercial air transport of passengers, the operator of an aircraft registered in the Territory must not permit any member of the flight crew to simulate

emergency manoeuvres and procedures which the operator has reason to believe will adversely affect the flight characteristics of the aircraft.

### **Loading - commercial air transport aircraft and suspended loads**

**100.**—(1) The operator of an aircraft registered in the Territory must not cause or permit it to be loaded for a flight for the purpose of commercial air transport, or any load to be suspended from it, except under the supervision of a person to whom written instructions have been provided as to the distribution and securing of the load so as to ensure that—

- (a) the load may safely be carried on the flight; and
- (b) any conditions subject to which the certificate of airworthiness in force for the aircraft was issued or rendered valid or contained in the flight manual for the aircraft relating to the loading of the aircraft are complied with.

(2) The person supervising the loading of the aircraft must, before the commencement of any such flight, prepare and sign a load sheet in duplicate conforming to the specified requirements, and must (unless that person is the pilot-in-command of the aircraft) submit the load sheet for examination by the pilot-in-command of the aircraft who shall sign the same.

(3) The operator of an aircraft registered in the Territory and flying for the purpose of the commercial air transport of passengers must not cause or permit baggage to be carried in the passenger compartment of the aircraft unless such baggage can be properly secured.

### **Aeroplane operating conditions and performance requirements**

**101.**—(1) An aeroplane registered in the Territory must not fly for the purpose of commercial air transport unless it complies with such data as may be approved by the State of design and contained in the flight manual for the aeroplane and the specified requirements or instructions given by the Governor under article 74—

- (a) in respect of its weight and related performance;
- (b) for flight in specified meteorological conditions; and
- (c) for flight at night.

(2) An aeroplane need not comply with paragraph (1) to the extent necessary for compliance with the terms of an approval granted to the operator under paragraph (3).

(3) The Governor may grant to the operator of any aeroplane an approval as provided for in the specified requirements or authorising it to comply with alternative performance standards appropriate to the aeroplane and specified in the approval.

(4) An aeroplane registered in the Territory when flying over water for the purpose of commercial air transport must fly, except as may be necessary for the purpose of take-off or landing, at such an altitude as would enable the aeroplane—

- (a) if it has one engine only, in the event of the failure of that engine; or
- (b) if it has more than one engine, in the event of the failure of one of those engines and with the remaining engine or engines operating within the maximum continuous power conditions specified in the certificate of airworthiness or flight manual for the aeroplane;

to reach a place at which, from a height sufficient to enable it to do so, it can safely land unless it is flying under and in accordance with the terms of an approval granted by the Governor.

### **Helicopters - operating conditions and performance requirements**

**102.**—(1) A helicopter registered in the Territory must not fly for the purpose of commercial air transport unless it complies with such data as may be approved by the State of design and contained

in the flight manual for the helicopter and the specified requirements or instructions given by the Governor under article 74—

- (a) in respect of its weight and related performance;
- (b) for flight in specified meteorological conditions; and
- (c) for flight at night.

(2) A helicopter need not comply with paragraph (1) to the extent necessary for compliance with the terms of an approval granted to the operator under paragraph (3).

(3) The Governor may grant to the operator of any helicopter an approval as provided for in the specified requirements or authorising it to comply with alternative performance standards appropriate to the helicopter and specified in the approval.

(4) Except as provided in paragraph (5), and except as may be necessary for the purpose of take-off or landing, a helicopter registered in the Territory when flying over water for the purpose of commercial air transport must fly at such an altitude as would enable the helicopter—

- (a) if it has one engine only, in the event of the failure of that engine; or
- (b) if it has more than one engine, in the event of the failure of one of those engines and with the remaining engine or engines operating within the maximum continuous power conditions specified in the certificate of airworthiness or flight manual for the helicopter;

to reach a place at which, from a height sufficient to enable it to do so, it can safely land unless it is flying under and in accordance with the terms of an approval granted by the Governor.

(5) A helicopter carrying out Performance Class 3 operations must not fly over water for the purpose of commercial air transport in the specified circumstances unless it is equipped with the required apparatus.

(6) A helicopter to which paragraph (5) applies which is equipped with the required apparatus and which is flying under and in accordance with the terms of an air operator's certificate granted under article 94 must not fly in the specified circumstances except in accordance with any additional requirements specified by the Governor in relation to its equipment.

(7) A helicopter to which paragraph (5) applies which is equipped with the required apparatus and which is flying under and in accordance with the terms of a police air operator's certificate—

- (a) on which any passenger is carried who is not a permitted passenger, must not fly in the specified circumstances on any flight for more than 20 minutes; or
- (b) on which no passenger is carried other than a permitted passenger, must not fly over water on any flight for more than 10 minutes so as to be more than 5 minutes from a point from which it can make an autorotative descent to land at a place suitable for an emergency landing.

(8) For the purposes of paragraph (7) flying time is calculated at normal cruising speed.

(9) For the purposes of this article—

- (a) “permitted passenger” means—
  - (i) a police officer;
  - (ii) an employee of a police authority;
  - (iii) a medical attendant;
  - (iv) the holder of a valid pilot's licence who intends to act as a member of the flight crew of an aircraft flying under and in accordance with the terms of a police air operator's certificate and who is being carried for the purpose of training or familiarisation; or
  - (v) such other person being carried for purposes connected with police operations as may be permitted in writing by the Governor;

- (b) “required apparatus” means apparatus approved by the Governor enabling the helicopter to which it is fitted to land safely on water;
- (c) “specified circumstances” means circumstances in which a helicopter is flying beyond a point from which it can make an autorotative descent to land at a place suitable for an emergency landing.

### **Commercial air transport operations at night or in instrument meteorological conditions by single engine aeroplanes**

**103.** A single-engine aeroplane, or a two-engine aeroplane that is unable to maintain a positive climb gradient in the event of an engine failure on take-off, must not be flown for the purpose of commercial air transport at night or in instrument meteorological conditions unless it is flying on a special VFR flight in a control zone.

### **Commercial air transport aircraft registered in the Territory – aerodrome-operating minima**

**104.**—(1) This article applies to commercial air transport aircraft registered in the Territory.

(2) An aircraft to which this article applies must not conduct a Category II operation, an Other than Standard Category II operation or an approach and landing using minima lower than those for a Category II operation unless—

- (a) the aircraft is certificated for operations with decision heights below 200 feet, or no decision height, and is equipped for such operations; and
- (b) the operation is conducted under and in accordance with the terms of an approval issued by the Governor.

(3) An aircraft to which this article applies must not—

- (a) take off when the relevant runway visual range is less than the specified runway visual range; or
- (b) conduct an approach and landing when the visibility or relevant runway visual range is less than that specified for a Category I operation;

except under and in accordance with the terms of an approval so to do issued by the Governor.

(4) The operator of every aircraft to which this article applies must establish and include in the operations manual relating to the aircraft the particulars of the aerodrome operating minima (in this article called “the particulars”) appropriate to every aerodrome of intended departure or landing and every alternate aerodrome.

(5) In relation to any flight where an operations manual is not required under article 96, or it is not practicable to include the particulars in the operations manual, the operator of the aircraft must, prior to the commencement of the flight, cause to be provided in writing to the pilot-in-command of the aircraft the particulars calculated in accordance with the required data and instructions (as defined in paragraph (6) of this article) and the operator shall cause a copy of the particulars to be retained outside the aircraft for a minimum period of three months.

(6) The operator of every aircraft to which this article applies for which an operations manual is required by this Order, must include in that operations manual such data and instructions (in this article called “the required data and instructions”) as will enable the pilot-in-command of the aircraft to calculate the aerodrome operating minima appropriate to aerodromes the use of which cannot reasonably have been foreseen by the operator prior to the commencement of the flight.

(7) The operator of every such aircraft to which this article applies for which an operations manual is not required must, prior to the commencement of the flight, cause to be provided in writing to the pilot-in-command of the aircraft the required data and instructions; and the operator must cause a

copy of the required data and instructions to be retained outside the aircraft for a minimum period of three months.

(8) The specified aerodrome operating minima must not permit a landing or take-off in circumstances where the relevant aerodrome operating minima declared by the competent authority would prohibit it, unless that authority otherwise permits in writing.

(9) In establishing aerodrome-operating minima for the purposes of this article the operator of the aircraft must take into account the following matters—

- (a) the type and performance and handling characteristics of the aircraft and any relevant conditions in its certificate of airworthiness;
- (b) the composition of its crew;
- (c) the physical characteristics of the relevant aerodrome and its surroundings;
- (d) the dimensions of the runways which may be selected for use; and
- (e) whether or not there are in use at the relevant aerodrome any aids, visual or otherwise, to assist aircraft in approach, landing or take-off, being aids which the crew of the aircraft are trained and equipped to use; the nature of any such aids that are in use; and the procedures for approach, landing and take-off which may be adopted according to the existence or absence of such aids;

and must establish in relation to each runway which may be selected for use such aerodrome operating minima as are appropriate to each set of circumstances which can reasonably be expected.

(10) An aircraft to which this article applies must not commence a flight at a time when—

- (a) the cloud ceiling or the runway visual range at the aerodrome of departure is less than the relevant minimum specified for take-off; or
- (b) according to the information available to the pilot-in-command of the aircraft it would not be able without contravening paragraphs (11) or (12), to land at the aerodrome of intended destination at the estimated time of arrival there and at any alternate aerodrome at any time at which according to a reasonable estimate the aircraft would arrive there.

(11) An aircraft to which article 96 of this Order applies, when making a descent to an aerodrome, must not descend from a height of 1000 feet or more above the aerodrome to a height less than 1000 feet above the aerodrome if the reported visibility or relevant runway visual range at the aerodrome is at the time less than the specified minimum for landing.

(12) An aircraft to which this article applies, when making a descent to an aerodrome, must not—

- (a) continue an approach to landing at any aerodrome by flying below the relevant specified decision height; or
- (b) descend below the relevant specified minimum descent height;

unless in either case from such height the specified visual reference for landing is established and is maintained.

(13) If, according to the information available, an aircraft would as regards any flight be required by the Rules of the Air to be flown in accordance with the Instrument Flight Rules at the aerodrome of intended landing, the pilot-in-command of the aircraft must select prior to take-off an alternate aerodrome unless no aerodrome suitable for that purpose is available.

(14) In this article “specified” in relation to aerodrome operating minima means such particulars of aerodrome operating minima as have been specified by the operator in, or are ascertainable by reference to, the operations manual relating to that aircraft, or provided in writing to the pilot-in-command of the aircraft by the operator in accordance with paragraph (5).

(15) In this article “Category I operation”, “Category II operation” and “Other than Standard Category II operation” have the same meaning as in article 105(9).



## **Commercial air transport aircraft not registered in the Territory – aerodrome-operating minima**

**105.**—(1) This article applies to commercial air transport aircraft registered in a country other than the Territory.

(2) An aircraft to which this article applies must not conduct a Category II operation, an Other than Standard Category II operation or an approach and landing using minima lower than those for a Category II operation unless—

- (a) the aircraft is certificated for operations with decision heights below 200 feet, or no decision height, and is equipped for such operations; and
- (b) the operation is conducted under the terms of an approval so to do;

in accordance with the law of the country in which it is registered.

(3) An aircraft to which this article applies must not—

- (a) take off when the relevant runway visual range is less than the specified runway visual range; or
- (b) conduct an approach and landing when the visibility or relevant runway visual range is less than that specified for a Category I operation;

except under and in accordance with the terms of an approval so to do granted in accordance with the law of the country in which it is registered.

(4) An aircraft to which this article applies must not fly in or over the Territory unless the operator of it has made available to the flight crew aerodrome operating minima that comply with paragraph (5) in respect of every aerodrome at which it is intended to land or take off and every alternate aerodrome.

(5) The aerodrome operating minima provided in accordance with paragraph (4) must be no less restrictive than either—

- (a) minima calculated in accordance with the notified method for calculating aerodrome operating minima; or
- (b) minima which comply with the law of the country in which the aircraft is registered;

whichever is the more restrictive.

(6) An aircraft to which this article applies must not take off or land at an aerodrome in the Territory in contravention of the specified aerodrome operating minima.

(7) Without prejudice to the provisions of paragraphs (5) and (6) an aircraft to which this article applies, when making a descent to an aerodrome, must not descend from a height of 1000 feet or more above the aerodrome to a height of less than 1000 feet above the aerodrome if the reported visibility or relevant runway visual range at the aerodrome is at the time less than the specified minimum for landing.

(8) Without prejudice to the provisions of paragraphs (5), (6) and (7) an aircraft to which this article applies, when making a descent to an aerodrome must not—

- (a) continue an approach to landing at any aerodrome by flying below the relevant specified decision height; or
- (b) descend below the relevant specified minimum descent height;

unless, in either case, from such height the specified visual reference for landing is established and is maintained.

(9) In this article—

- (a) “specified” means specified by the operator in the aerodrome operating minima made available to the flight crew under paragraph (4);

- (b) “Category I operation” means a precision instrument approach and landing with a decision height not lower than 200 feet and with either a visibility not less than 800 metres or a runway visual range not less than 550 metres;
- (c) “Category II operation” means a precision approach and landing using an Instrument Landing System or Microwave Landing System with—
  - (i) a decision height below 200 feet but not lower than 100 feet; and
  - (ii) a runway visual range of not less than 300 metres;
- (d) “Other than Standard Category II operation” means a Category II operation to a runway where some or all of the elements of the ICAO Annex 14 precision approach Category II lighting system are not available.

### **Carriage of passengers - additional duties of pilot-in-command**

**106.**—(1) This article applies to flights for the purpose of the commercial air transport of passengers by aircraft registered in the Territory.

(2) Before an aircraft takes off on a flight to which this article applies, and before it lands, the pilot-in-command must take all reasonable steps to ensure that the crew of the aircraft are properly secured in their seats and that any persons carried in compliance with article 42 are properly secured in seats which are located as far as is practical near floor level and close to emergency exits.

(3) From the moment when, after the embarkation of its passengers for the purpose of taking off on a flight to which this article applies—

- (a) an aircraft first moves until after it has taken off,
- (b) before it lands until it comes to rest for the purpose of the disembarkation of its passengers, and
- (c) whenever by reason of turbulent air or any emergency occurring during the flight the pilot-in-command considers it necessary,

the pilot-in-command must take all reasonable steps to ensure that all passengers of 2 years of age or more are properly secured in their seats by safety belts (with diagonal shoulder strap, where required to be carried) or safety harnesses and that all passengers under the age of 2 years are properly secured by means of a child restraint device.

(4) The pilot-in-command must ensure that an aircraft with a non-pressurised cabin is not operated above flight level 100, except under and in accordance with the terms of an approval granted by the Governor.

(5) Except where the cabin pressure altitude does not exceed 10,000 feet during the flight, the pilot-in-command must take all reasonable steps to ensure that—

- (a) before the aircraft reaches flight level 130 the method of use of the oxygen provided in the aircraft in compliance with the requirements of article 35 is demonstrated to all passengers;
- (b) when flying above flight level 130 all passengers and cabin crew are instructed to use oxygen; and
- (c) during any period when the aircraft is flying above flight level 100 oxygen is used continuously by all the flight crew of the aircraft.

## PART 11

### CARRIAGE OF WEAPONS AND MUNITIONS OF WAR

#### Carriage of weapons and of munitions of war

**107.**—(1) Subject to article 108 an aircraft must not carry any munitions of war unless—

- (a) the munitions of war are carried with the permission of the Governor; and
- (b) the pilot-in-command of the aircraft is informed in writing by the operator before the flight commences of the type, weight or quantity and location of any such munitions of war on board or suspended beneath the aircraft and of any conditions of the permission of the Governor.

(2) Subject to article 108, it is unlawful for an aircraft to carry any sporting weapon or munitions of war in any compartment or apparatus to which passengers have access.

(3) Subject to article 108, it is unlawful for a person to carry or have in their possession or take or cause to be taken on board an aircraft, to suspend or cause to be suspended beneath an aircraft or to deliver or cause to be delivered for carriage on an aircraft any sporting weapon or munitions of war unless—

- (a) the sporting weapon or munitions of war—
  - (i) are either part of the baggage of a passenger on the aircraft or consigned as cargo;
  - (ii) are carried in a part of the aircraft, or in any apparatus attached to the aircraft inaccessible to passengers; and
  - (iii) in the case of a firearm, is unloaded;
- (b) information about the sporting weapon or munitions of war has been supplied by that passenger or by the consignor to the operator before the flight commences; and
- (c) the operator consents to the carriage of such sporting weapon or munitions of war by the aircraft.

#### Exceptions concerning carriage of weapons and munitions of war

**108.**—(1) In the case of an aircraft which is flying under and in accordance with the terms of a police air operator's certificate the pilot-in-command of the aircraft must be informed of the matters referred to in article 107(1)(b), but need not be so informed in writing.

(2) Article 107(2) and (3) do not apply to or in relation to an aircraft which is flying under and in accordance with the terms of a police air operator's certificate.

(3) Nothing in article 107 applies to any sporting weapon or munitions of war taken or carried on board an aircraft registered in a country other than the Territory if, under the law of the country in which the aircraft is registered, the sporting weapon or munitions of war may be lawfully taken or carried on board for the purpose of ensuring the safety of the aircraft or of persons on board.

#### Definitions

**109.** In this Part—

“munitions of war” means—

- (a) any weapon or ammunition;
- (b) any article containing an explosive, noxious liquid or gas; or
- (c) any other thing;

which is designed or made for use in warfare or against persons, including parts, whether components or accessories, for such weapon, ammunition or article;

“sporting weapon” means—

- (a) any weapon or ammunition;
- (b) any article containing an explosive, noxious liquid or gas; or
- (c) any other thing, including parts, whether components or accessories, for such weapon, ammunition or article;

which is not a munition of war.

## PART 12

### CARRIAGE OF DANGEROUS GOODS

#### Requirements for the carriage of dangerous goods

**110.**—(1) An aircraft must not carry or have loaded on to it any dangerous goods unless—

- (a) the operator is approved by the Governor under this Part or has a permission under article 128;
- (b) the goods are carried or loaded in accordance with any conditions to which such approval or permission may be subject; and
- (c) the goods are carried in accordance with the specified requirements or instructions given by the Governor under article 74.

(2) The Governor must grant an approval under paragraph (1)(a) upon being satisfied that the operator is competent to carry dangerous goods safely.

(3) Nothing in this Part, other than paragraph (1), applies to the carriage of dangerous goods by an aircraft flying under and in accordance with the terms of a police air operator’s certificate.

(4) Nothing in this Part, other than paragraph (1), applies to any aircraft flying for the purpose of dropping articles for the purposes of public health, agriculture, horticulture, forestry, conservation or pollution control.

#### Prohibition on carriage of dangerous goods

**111.** A person must not deliver or cause to be delivered for carriage, or take or cause to be taken on board an aircraft, any dangerous goods which may pose a risk to health, safety, property or the environment when carried by air—

- (a) except in accordance with the specified requirements or the Governor’s instructions under article 74; and
- (b) unless the packaging of those goods is in a fit condition for carriage by air.

#### Operator’s obligations

**112.** The operator of an aircraft that is either an air transport undertaking, or an organisation to which article 133 applies, must ensure—

- (a) that all appropriate manuals, including operations manuals, contain information and instructions about dangerous goods so as to enable the ground staff and crew members to carry out their responsibilities regarding the carriage of dangerous goods;

- (b) that, if applicable, such information and instructions are provided to the operator's handling agent;
- (c) that, before the flight begins, the pilot-in-command is given written information about the dangerous goods and information required for use in responding to an in-flight emergency; and
- (d) that, if an aircraft carrying any dangerous goods is involved in an accident or serious incident, notification of any dangerous goods carried as cargo on the aircraft is given immediately to the Governor and a police officer for the area where the accident or serious incident occurred.

#### **Acceptance of dangerous goods by the operator**

- 113.** The operator of an aircraft in which dangerous goods are to be carried must ensure that—
- (a) no package or freight container containing dangerous goods is accepted for carriage until it has been inspected to determine that it complies with the specified requirements;
  - (b) the goods are not forbidden for carriage by air in any circumstances; and
  - (c) any package or freight container is accompanied by a dangerous goods transport document.

#### **Method of loading by the operator**

**114.** The operator of an aircraft in which dangerous goods are to be carried must ensure that such goods are not carried in any compartment occupied by passengers or on the flight deck, except in circumstances permitted by the specified requirements.

#### **Inspections by the operator for damage, leakage or contamination**

**115.** The operator of an aircraft in which dangerous goods are to be carried must ensure that packages and freight containers which contain such goods are inspected for evidence of damage or leakage before being loaded on an aircraft, in accordance with the specified requirements.

#### **Shipper's responsibilities**

- 116.** Before consigning any goods for carriage by air the shipper must ensure that—
- (a) the goods are not forbidden for carriage by air;
  - (b) if the goods are forbidden for carriage by air without approval, all such approvals have been obtained;
  - (c) the goods are classified and packed in accordance with the specified requirements;
  - (d) the package is marked and labelled in English, in addition to any other language required by the State of Origin;
  - (e) the package is in a fit condition for carriage by air;
  - (f) a dangerous goods transport document has been completed in English, in addition to any other language required by the State of Origin, containing a declaration that the specified requirements have been complied with; and
  - (g) the operator has been given the dangerous goods transport document.

#### **Pilot-in-command's responsibilities**

**117.** The pilot-in-command of an aircraft carrying dangerous goods as cargo must, in the event of an in-flight emergency and as soon as the situation permits, inform the appropriate air traffic services

unit of such goods in detail or as a summary or by reference to the location from where the detailed information can be obtained.

### **Provision of training by operators and shippers**

**118.**—(1) The operator of an aircraft, its handling agent, a shipper of dangerous goods by air and any agent of the shipper, must establish and undertake training programmes for those of their employees and staff who are involved in the carriage of goods or passengers by air.

(2) In the case of an operator or its agents, the training programme must be approved by, or acceptable, to the Governor.

(3) In the case of a shipper or its agent, the training programme must meet the specified requirements.

### **Provision of information to passengers**

**119.**—(1) This article applies to—

- (a) any airport operator in the Territory;
- (b) the operator of an aircraft flying for the purpose of commercial air transport of passengers or its agent; and
- (c) any person who in the Territory makes available flight accommodation and for this purpose “flight accommodation” means accommodation for the carriage of persons on flights in any part of the world.

(2) Any person to whom paragraph (1) applies must ensure that persons who are or may become passengers on an aircraft flying for such purposes are warned as to the types of dangerous goods which they are forbidden from carrying on an aircraft as checked baggage or with them in accordance with the specified requirements.

### **Provision of information in respect of cargo**

**120.** The operator of an aircraft in which cargo is to be carried and any agent of the operator must ensure that notices giving information about the carriage of dangerous goods are displayed in accordance with the specified requirements.

### **Keeping of documents and records**

**121.** The operator of an aircraft carrying dangerous goods as cargo must ensure that a copy of the dangerous goods transport document required by article 116(f) and the written information to the pilot-in-command required by article 112(c) are retained at a readily accessible location until after completion of the flight on which the goods are carried and to produce them upon request.

### **Preservation of documents and records**

**122.** The operator of an aircraft on which dangerous goods are carried must preserve in a legible form for not less than three months any dangerous goods transport document or other document prescribed in the specified requirements.

### **Enforcement powers**

**123.**—(1) An authorised person may—

- (a) examine, take samples of and seize any goods which the authorised person has reasonable grounds to suspect may be dangerous goods in respect of which the provisions of this Part have not been complied with;
- (b) open or require to be opened any baggage or package which the authorised person has reasonable grounds to suspect may contain dangerous goods in respect of which the provisions of this Part have not been complied with;
- (c) retain or detain any sample taken or goods seized under this article for so long as the Governor considers necessary for use as evidence at a trial for any offence or for forensic examination or investigation in connection with any offence; and
- (d) dispose of such goods in such manner as the Governor considers appropriate.

(2) Any person from whom goods have been seized by an authorised person under this article may make application to the Governor for the goods to be released, accompanied by evidence of ownership, and if the Governor is satisfied that the applicant is the owner and that the retention of the goods is not necessary for the purpose of any criminal proceedings the Governor must arrange for the goods to be returned to the applicant.

(3) Where further retention of the goods is, in the opinion of the Governor, no longer necessary and no application has been made under paragraph (2), or any such application has been unsuccessful, the goods must be destroyed or otherwise disposed of as directed by the Governor.

### **Dangerous goods occurrence reporting**

**124.**—(1) Any dangerous goods accident, incident or finding of undeclared or misdeclared dangerous goods in cargo or passengers' baggage must be reported to the Governor in accordance with the specified requirements by—

- (a) a Territory operator, wherever it occurs;
- (b) a non-Territory operator, if it occurs in the Territory.

(2) A report required under paragraph (1) must contain such information specified by the Governor as is appropriate to the occurrence.

(3) Nothing in this article requires a person to report any occurrence which has been reported under article 174 or which the person has reason to believe has been or will be reported by another person to the Governor in accordance with that article.

### **Definitions and interpretation**

**125.** In this Part—

“dangerous goods” means any article or substance which is identified as such in the specified requirements;

“dangerous goods accident” means an occurrence associated with and related to the carriage of dangerous goods by air which results in fatal or serious injury to a person or major property or environmental damage;

“dangerous goods incident” means an occurrence, other than a dangerous goods accident, which—

- (a) is associated with and related to the carriage of dangerous goods by air, not necessarily occurring on board an aircraft, which results in injury to a person, property or environmental damage, fire, breakage, spillage, leakage of fluid or radiation or other evidence that the integrity of the packaging has not been maintained; or
- (b) relates to the carriage of dangerous goods and which seriously jeopardises the aircraft or its occupants;

“dangerous goods transport document” means a document which is specified in the specified requirements;

“handling agent” means an agent who performs on behalf of the operator some or all of the functions of the latter including receiving, loading, unloading, transferring or other processing of passengers or cargo;

“package” means the complete product of the packing operation consisting of the packaging and its contents prepared for carriage;

“packaging” means the receptacles and any other components or materials necessary for the receptacle to perform its containment function;

“serious injury” means an injury which is sustained by a person in an accident and which—

- (a) requires hospitalisation for more than 48 hours, commencing within seven days from the date the injury was received; or
- (b) results in a fracture of any bone (except simple fractures of fingers, toes or nose); or
- (c) involves lacerations which cause severe haemorrhage, nerve, muscle or tendon damage; or
- (d) involves injury to any internal organ; or
- (e) involves second or third degree burns, or any burns affecting more than 5 per cent of the body surface; or
- (f) involves verified exposure to infectious substances or injurious radiation.

## PART 13

### AERIAL WORK AND SPECIALISED OPERATIONS

#### **Aerial work**

**126.**—(1) Aerial work means any purpose (other than commercial air transport) for which an aircraft is flown if valuable consideration is given or promised in respect of the flight or the purpose of the flight.

(2) If the only such valuable consideration consists of remuneration for the services of the pilot the flight is deemed to be a private flight for the purposes of Part 3.

#### **Aerial work operations**

**127.**—(1) Subject to articles 128, 129 and 130, an aircraft must not be used for the purpose of aerial work (in this article, an “aerial work operation”) otherwise than in accordance with the Governor’s instructions given under article 74 and with the specified requirements.

(2) Before commencing any aerial work operation, the operator of the aircraft must carry out a risk assessment and must develop appropriate standard operating procedures to provide guidance to operating staff to ensure a safe means of carrying out the aerial task.

(3) In complying with paragraph (2) the operator must have regard to—

- (a) the type of aerial work activity; and
- (b) the operating environment.

(4) The operator must make the standard operating procedures referred to in paragraph (2) available to every employee or person who is engaged or may engage in any aerial work operations conducted by the operator.



(5) The operator must ensure that the risk assessment is reviewed and guidance to operating staff kept up to date, taking into account any changes affecting the operation.

### **Aerial application permission for purposes of agriculture etc**

**128.**—(1) Subject to article 129, an aircraft must not be used for the dropping of articles or animals for the purposes of agriculture, horticulture, forestry or conservation or for training for the dropping of articles for any of such purposes, otherwise than under and in accordance with the terms of a written permission granted by the Governor under this article (in this article, an “aerial application permission”).

(2) Every applicant for and holder of an aerial application permission must make available to the Governor if requested an operations manual containing such information and instructions as may be necessary to enable employees and persons engaged in the operation to perform their duties.

(3) The operations manual must include standard operating procedures as described in article 127(2).

(4) The holder of an aerial application permission must make such amendments or additions to the operations manual as the Governor may require.

### **Towing, picking up, raising and lowering of persons, animals and articles**

**129.**—(1) An aircraft in flight must not, by means external to the aircraft tow any article or pick up, raise or lower any person, animal or article—

(a) unless there is a certificate of airworthiness issued or rendered valid in respect of that aircraft under the law of the country in which the aircraft is registered and that certificate or the flight manual for the aircraft includes an express provision that it may be used for that purpose; and

(b) if it is a helicopter, otherwise than under and in accordance with the terms of a written permission granted by the Governor under this article or article 128.

(2) An aircraft in flight must not tow any article, other than a glider, at night or when flight visibility is less than one nautical mile.

(3) The length of the combination of towing aircraft, tow rope, and article in tow, must not exceed 150 metres.

(4) An aeroplane must not launch or pick up tow ropes, banners or similar articles other than at an aerodrome.

(5) Every applicant for, and holder of, a permission required under paragraph (1) must make available to the Governor if requested an operations manual containing such information and instructions as may be necessary to enable employees and persons engaged in the operation to perform their duties.

(6) The operations manual must include standard operating procedures as described in article 127(2) of this Order.

(7) The holder of the permission must make such amendments or additions to the operations manual as the Governor may require.

(8) A helicopter must not fly at any height over a congested area of a city, town or settlement at any time when any article, person or animal is suspended from the helicopter.

(9) A person who is not a member of the flight crew must not be carried in a helicopter at any time when an article, person or animal is suspended from the helicopter, other than—

(a) a task specialist who has duties to perform in connection with the article, person or animal;  
or

- (b) a person who has been picked up or raised by means external to the helicopter; or
  - (c) a person who it is intended must be lowered to the surface by means external to the helicopter.
- (10) Nothing in this article—
- (a) prohibits the towing in a reasonable manner by an aircraft in flight of any radio aerial, any instrument which is being used for experimental purposes, or any signal, apparatus or article required or permitted by or under this Order to be towed or displayed by an aircraft in flight; or
  - (b) prohibits the picking up, raising or lowering of any person, animal or article in an emergency or for the purpose of saving life.

### **Dropping of articles and animals**

**130.**—(1) Articles and animals (whether or not attached to a parachute) must not be dropped, or be permitted to drop, from an aircraft in flight so as to endanger persons or property.

(2) Subject to paragraphs (3) and (4), articles and animals (whether or not attached to a parachute) must not be dropped, or be permitted to drop, to the surface from an aircraft flying over the Territory except under and in accordance with the terms of an aerial application permission granted under article 128.

(3) Paragraph (2) does not apply to the dropping of articles by, or with the authority of, the pilot-in-command of the aircraft in any of the following circumstances—

- (a) the dropping of articles for the purpose of saving life;
- (b) the jettisoning, in case of emergency, of fuel or other articles in the aircraft;
- (c) the dropping of ballast in the form of fine sand or water;
- (d) the dropping of articles solely for the purpose of navigating the aircraft in accordance with ordinary practice or with the provisions of this Order;
- (e) the dropping at an aerodrome of tow ropes, banners, or similar articles towed by aircraft;
- (f) the dropping of articles for the purposes of public health or as a measure against weather conditions, surface icing or oil pollution, or for training for the dropping of articles for any such purposes, if the articles are dropped with the permission of the Governor; or
- (g) the dropping of wind drift indicators for the purpose of enabling parachute descents to be made if the wind drift indicators are dropped with the permission of the Governor.

(4) Paragraph (2) does not apply to the lowering of any article or animal from a helicopter to the surface in accordance with article 129.

### **Dropping of persons**

**131.**—(1) Subject to paragraph (7), a person must not drop, be dropped or be permitted to drop to the surface or jump from an aircraft flying over the Territory except under and in accordance with the terms of a written permission granted by the Governor under this article.

(2) A person must not drop, be dropped or be permitted to drop from an aircraft in flight so as to endanger persons or property.

(3) An aircraft must not be used for the purpose of dropping persons unless—

- (a) there is a certificate of airworthiness issued or rendered valid in respect of that aircraft under the law of the country in which the aircraft is registered; and
- (b) that certificate or the flight manual includes an express provision that it may be used for that purpose; and

- (c) the aircraft is operated in accordance with a written permission granted by the Governor under this article.
- (4) Every applicant for, and holder of, a parachuting permission must make available to the Governor if requested a parachuting operations manual containing such information and instructions as may be necessary to enable employees and persons engaged in the operation to perform their duties.
- (5) The operations manual must include standard operating procedures as described in article 127.
- (6) The holder of a parachuting permission must make such amendments or additions to the operations manual as the Governor may require.
- (7) Nothing in this article—
  - (a) applies to the descent of persons by parachute from an aircraft in an emergency;
  - (b) prohibits the lowering of any person in an emergency or for the purpose of saving life;
  - (c) prohibits the disembarkation of any person from a helicopter hovering in ground effect in accordance with normal aviation practice; or
  - (d) prohibits the lowering of any person from a helicopter to the surface in accordance with article 129.

## PART 14

### GENERAL AVIATION

#### **Application and interpretation**

**132.**—(1) Except as provided in paragraph (2) of article 133, articles 133 and 134 apply to general aviation operations involving aircraft registered in the Territory of the classes or used in the cases identified in paragraph (2).

- (2) Aircraft or aircraft operations of the classes or cases to which paragraph (1) refers are—
  - (a) any aeroplane having a maximum certificated take-off weight exceeding 5700 kg;
  - (b) any aeroplane equipped with one or more turbojet engines;
  - (c) any aeroplane having a maximum approved passenger seating configuration of more than 9;
  - (d) any helicopter having a maximum certificated take-off weight exceeding 3175 kg;
  - (e) any helicopter having a maximum approved passenger seating configuration of more than 5;
  - (f) any aircraft operation involving the use of three or more aircraft that are operated by pilots employed by the operator for the purpose of flying the aircraft; or
  - (g) any other general aviation operation that the Governor may in the public interest specify.
- (3) For the purposes of this Part—
  - (a) “general aviation operation” means an aircraft operation other than a commercial air transport operation or aerial work operation;
  - (b) “commercial air transport operation” means an aircraft operation for the purposes of commercial air transport; and
  - (c) “aerial work operation” has the same meaning as in article 127(1).

### **Requirement for Approval**

**133.**—(1) A person must not operate an aircraft registered in the Territory of any class or in any case identified in article 132(2), for the purposes of a general aviation operation, unless the person is the holder of an approval granted under article 134.

(2) An approval is not required if operations of any of the classes identified in article 132(2) are being undertaken by an air transport undertaking that holds a valid air operator certificate granted in accordance with article 94.

### **Issue and conditions of Approval**

**134.**—(1) The Governor must grant an approval required under article 133 upon being satisfied that—

- (a) the applicant is competent, having regard in particular to the applicant's—
  - (i) previous conduct and experience;
  - (ii) equipment;
  - (iii) organisation and staffing;
  - (iv) maintenance and other arrangements;
- (b) the safety management system established in accordance with paragraph (2) is appropriate and adequate; and
- (c) the operations manual is adequate;

to secure the safe operation of aircraft of the type or types specified in the approval.

(2) An operator applying for an approval under the provisions of paragraph (1) must establish and maintain to the satisfaction of the Governor a safety management system appropriate to the size and complexity of the operation.

(3) The operator of every aircraft to which this article applies must—

- (a) make available to each member of the operating staff an operations manual;
- (b) ensure that each copy of the operations manual is kept up to date; and
- (c) ensure that on each flight every member of the crew has access to a copy of every part of the operations manual which is relevant to his or her duties on that flight.

(4) An operations manual must contain all information and instructions necessary to enable operating staff to perform their duties as such.

(5) Every applicant for, and holder of, an approval granted under this article must make available to the Governor if requested to do so a copy of the operations manual.

(6) The operator must make such amendments or additions to the operations manual as the Governor may require for the purpose of ensuring the safety of the aircraft or of persons or property carried in it or the safety of air navigation.

## **PART 15**

### **FOREIGN AIRCRAFT OPERATIONS**

#### **Restriction with respect to carriage for valuable consideration in aircraft registered outside the Territory**

**135.**—(1) An aircraft registered in a Contracting State, other than the United Kingdom or any of the Territories, or in any country other than the United Kingdom, must not take on board or discharge

any passengers or cargo in the Territory, if valuable consideration is given or promised in respect of the carriage of such persons or cargo unless it does so with the permission of the Secretary of State granted under this article to the operator or charterer of the aircraft or to the Government of the country in which the aircraft is registered, and in accordance with any conditions to which such permission may be subject.

(2) Any breach, by a person to whom permission has been granted under this article, of any condition to which that permission was subject constitutes a contravention of this article.

(3) The Secretary of State may, in any particular case, or class of cases, delegate to the Governor the exercise of the powers conferred on the Secretary of State under paragraph (1); and where the exercise of the powers conferred under paragraph (1) is so delegated, the Governor must, in exercising those powers, comply with any general guidelines or specific directions which may from time to time be given by the Secretary of State.

(4) An operator or charterer of an aircraft to which this article applies must not hold itself out as a person who may offer to take on board or discharge any passenger or cargo in the Territory for valuable consideration unless—

- (a) it does so in accordance with a permission granted under this article; and
- (b) it does so in accordance with any conditions to which such permission may be subject.

(5) The Secretary of State or the Governor may authorise a person (whether by name, class or description) either generally or in relation to a particular case or class of cases, to perform a ramp inspection or to carry out other surveillance measures in relation to any aircraft referred to in paragraph (1).

(6) If a ramp inspection or other surveillance measure identifies a case of non-compliance or suspected non-compliance of an aircraft referred to in paragraph (1) or by the operator of such an aircraft with the laws, regulations and procedures applicable within the Territory or a serious safety issue with the operator of such an aircraft, the person authorised under paragraph (5) must immediately notify the operator and, if the issue warrants it, the State of the operator and, where the State of registry and the State of the operator are different, such notification must also be made to the State of registry.

(7) In the case of notification to States in accordance with paragraph (6), if the issue and its resolution so warrant, the Secretary of State or the Governor, as the case may be, must engage in consultations with the State of the operator and the State of registry, as applicable, concerning the safety standards maintained by the operator.

### **Filing and approval of tariffs**

**136.**—(1) Where a permission granted under article 135 contains a tariff provision, the Secretary of State may, in any particular case or class of cases, delegate to the Governor the exercise of the power to approve or disapprove the tariff which the operator or charterer of the aircraft concerned proposes to apply on flights to which the permission relates, and where the power to approve or disapprove tariffs is so delegated, the Governor must, in exercising that power, comply with any general guidelines or specific directions which may from time to time be given by the Secretary of State.

(2) For the purposes of this article, “tariff provision” means a condition as to any of the following matters—

- (a) the price to be charged for the carriage of passengers, baggage or cargo on flights to which a permission granted under article 135(1) relates;
- (b) any additional goods, services or other benefits to be provided in connection with such carriage;
- (c) the prices, if any, to be charged for any such additional goods, services or benefits; and

- (d) the commission, or rates of commission, to be paid in relation to the carriage of passengers, baggage or cargo;

and includes any condition as to the applicability of any such price, the provision of any such goods, services or benefits or the payment of any such commission or of commission at any such rate.

### **Restriction on aerial photography, aerial survey and aerial work in aircraft registered outside the Territory**

**137.**—(1) Subject to article 127 an aircraft registered in a Contracting State other than the United Kingdom or any of the Territories, or in any country other than the United Kingdom, must not fly over the Territory for the purpose of aerial photography or aerial survey (whether or not valuable consideration is given or promised in respect of the flight or the purpose of the flight) or for the purpose of any other form of aerial work except with the permission of the Governor granted under this article to the operator or the charterer of the aircraft and in accordance with any conditions to which such permission may be subject.

(2) Any breach, by a person to whom a permission has been granted under this article, of any condition to which that permission was subject constitutes a contravention of this article.

## **PART 16**

### **AIR TRAFFIC SERVICES**

#### **Requirement for air traffic control approval for the provision of air traffic services**

**138.**—(1) A person in charge of the provision of an air traffic control service, other than at a military aerodrome, must not provide such a service in the Territory except under and in accordance with the terms of an air traffic control approval granted by the Governor.

(2) The Governor must grant an air traffic control approval upon being satisfied that the applicant meets the specified requirements and is competent to provide a service which is safe for use by aircraft.

#### **Duty of person in charge to satisfy himself as to competence of controllers**

**139.** The holder of an approval under article 138 must not permit any person to act as an air traffic controller, or to act as a student air traffic controller, in the provision of the service under the approval unless—

- (a) such person holds an appropriate licence; and
- (b) the holder is satisfied that such person is competent to perform the duties commensurate with the provision of the service.

#### **Manual of Air Traffic Services**

**140.** A person must not provide an air traffic control service at any place unless—

- (a) the service is provided in accordance with the standards and procedures specified in a manual of air traffic services in respect of that place;
- (b) the manual is produced to the Governor within a reasonable time after a request for its production is made by the Governor; and
- (c) such amendments or additions have been made to the manual as the Governor may from time to time require.

### **Provision of air traffic services**

**141.**—(1) In the case of an aerodrome (other than a military aerodrome) at which there is provision of aid for holding, aid for let-down or aid for an approach to landing by radio or radar, the person in charge of the aerodrome must—

- (a) inform the Governor in advance of the periods during which and the times at which any such provision is to be in operation for the purpose of providing such aid as is specified by the said person; and
- (b) during any period and at such times as are notified, cause an approach control service to be provided.

(2) The Governor may in the interests of safety direct the person in charge of an aerodrome (other than a military aerodrome) that there must be provided in respect of any aerodrome such air traffic control service, aerodrome flight information service or means of two-way radio communication as the Governor considers appropriate.

(3) In a direction given under this article the Governor may specify the periods during which, the times at which, the manner in which and the airspace within which such a service or such means shall be provided.

(4) The person who has been so directed shall cause such a service or such means to be provided in accordance with any such direction.

### **Use of radio call signs at aerodromes**

**142.** The person in charge of an aerodrome provided with means of two-way radio communication must not cause or permit any call sign to be used for a purpose other than a purpose for which that call sign has been notified.

## **PART 17**

### **LICENSING OF AIR TRAFFIC CONTROLLERS**

#### **Prohibition of unlicensed air traffic controllers and student air traffic controllers**

**143.**—(1) A person must not act as an air traffic controller or offer, whether by use of a radio call sign or in any other way, to act as a person who may so act unless such person is the holder of, and complies with the privileges and conditions of—

- (a) a valid student air traffic controller's licence granted under this Order and under supervision in accordance with article 144(5);
- (b) an appropriate valid air traffic controller's licence granted under this Order; or
- (c) a valid air traffic controller's licence so granted which is not appropriate but under supervision as though the person was the holder of a student air traffic controller's licence.

(2) Nothing in this article prohibits the holder of a valid air traffic controller's licence from providing at any place, or for any sector for which the licence includes a valid certificate of competence, information to aircraft in flight in the interests of safety.

(3) A licence is not required by any person who acts in the course of his or her duty as a member of any of Her Majesty's naval, military or air forces or as a member of a visiting force.

### **Licensing of air traffic controllers and student air traffic controllers**

**144.**—(1) The Governor must grant a licence to any person to act as an air traffic controller or as a student air traffic controller in the Territory upon being satisfied that the applicant—

- (a) is a fit person to act in the capacity to which the licence relates; and
- (b) meets the specified requirements, for which purpose the applicant must provide such evidence and undergo such examinations, assessments and tests (including medical examinations) and undertake such courses of training as the Governor may require.

(2) The Governor must not grant—

- (a) a student air traffic controller’s licence to any person under the age of 18 years; or
- (b) an air traffic controller’s licence to any person under the age of 20 years.

(3) The Governor may include in an air traffic controller’s licence any rating and endorsement upon being satisfied that the applicant is qualified as specified in paragraph (1)(b) to act in the capacity to which such rating or endorsement relates and such rating or endorsement is deemed to form part of the licence.

(4) A licence to act as an air traffic controller or a student air traffic controller is not valid unless the holder of the licence has signed it in ink.

(5) Every licence to act as a student air traffic controller is valid only for the purpose of authorising the holder to act as an air traffic controller under the supervision of another person who is present at the time and who is the holder of an air traffic controller’s licence including an on-the-job instructor training rating entitling that person to provide unsupervised the type of air traffic control service which is being provided by the student air traffic controller.

(6) Every holder of an air traffic controller’s licence or a student air traffic controller’s licence must, upon such occasions as the Governor may require, submit to such examinations and tests (including medical examinations) and provide such evidence as to the holder’s knowledge, experience, competence and skill and undergo such courses of training as the Governor may require.

(7) The holder of an air traffic controller’s licence is not entitled to exercise the privileges of a rating contained in the licence at any place or for any sector or with any type of surveillance equipment unless the licence includes a valid certificate of competence for that rating which is appropriate to that place or sector and that equipment (if any).

(8) A valid certificate of competence shall not be appropriate to the exercise of the privileges of a rating at any place or for any sector or with any type of surveillance equipment unless the certificate—

- (a) specifies that place or sector and the type of surveillance equipment (if any) with the aid of which the service is to be provided;
- (b) certifies that the person signing the certificate is satisfied that on a date specified in the certificate the holder of the licence, of which the certificate forms part, has passed an appropriate test of ability to exercise the privileges of the rating at the place or for the sector and with the type of surveillance equipment, if any, specified in the certificate; and
- (c) specifies the date on which it was signed.

(9) A valid certificate of competence issued under paragraph (7) must be signed by a person authorised by the Governor to sign certificates of that kind and is valid for 12 months from the date of the test which it certifies.

(10) If throughout any period of 90 days the holder of a licence has not at any time provided at a particular place or for a particular sector and with the aid of the type of surveillance equipment, if any, specified in a certificate of competence, the type of air traffic control service specified in the rating to which the certificate of competence relates, the certificate ceases to be valid for that place or sector at the end of that period.



(11) Upon a certificate of competence ceasing to be valid for a place or sector the holder of the licence must immediately inform the person who is approved under article 138 of this Order to provide an air traffic control service at that place or for that sector to that effect and must forward the licence to a person approved by the Governor for the purpose, who must endorse the licence accordingly and return it to the holder immediately.

### **Approval of courses and persons**

**145.** The Governor may, for the purposes of this Part of this Order—

- (a) approve any course of training or instruction;
- (b) authorise a person to conduct such examinations or tests as may be specified; and
- (c) approve a person to provide any course of training or instruction.

### **Requirement for medical certificate**

**146.—**(1) On the basis of the medical examination referred to in article 144(6), the Governor or any person approved by the Governor as competent to do so may issue a medical certificate to the effect that the holder of the licence has been assessed as fit to perform the functions to which the licence relates.

(2) The certificate is deemed to form part of the licence.

(3) The holder of an air traffic controller's licence must not act as an air traffic controller unless the licence includes a medical certificate issued and in force under paragraph (1).

(4) The holder of a student air traffic controller's licence must not act as a student air traffic controller unless the licence includes a medical certificate issued and in force under paragraph (1).

### **Incapacity of air traffic controllers**

**147.—**(1) Every holder of an air traffic controller's licence granted under article 144 who—

- (a) suffers any personal injury or illness involving incapacity to undertake the functions to which the licence relates throughout a period of 20 consecutive days; or
- (b) has reason to believe that she is pregnant;

must inform the Governor in writing of such injury, illness or pregnancy as soon as possible.

(2) An air traffic controllers' medical certificate ceases to be in force on the expiry of the period of injury or illness referred to in paragraph (1)(a) and comes into force again (provided it has not expired)—

- (a) upon the holder being medically examined under arrangements made by the Governor and pronounced fit to resume the functions under the licence; or
- (b) upon the Governor exempting the holder from the requirement of a medical examination subject to such conditions as the Governor may think fit.

### **Prohibition of drunkenness etc. of controllers**

**148.** A person must not act as an air traffic controller or a student air traffic controller whilst under the influence of drink or a drug to such an extent as to impair his or her capacity to act as such.

### **Fatigue of air traffic controllers - air traffic controller's responsibilities**

**149.** A person must not act as an air traffic controller if he or she knows or suspects that he or she is suffering from or, having regard to the circumstances of the period of duty to be undertaken,

is likely to suffer from, such fatigue as may endanger the safety of any aircraft to which an air traffic control service may be provided.

### **Prohibition of unlicensed flight information service officers**

**150.**—(1) A person must not provide at any aerodrome a flight information service or offer to do so, whether by use of a radio call sign or in any other way, as a person who may provide such a service without being the holder of and complying with the terms of a flight information service officer's licence, or air traffic controller's licence, granted under this Order authorising the provision of such a service at that aerodrome.

(2) A person must not provide a flight information service without being identified as such in such a manner as may be notified.

### **Licensing of flight information service officers**

**151.**—(1) The Governor must grant a licence to any person to act as a flight information service officer upon being satisfied that the applicant meets the specified requirements and is a fit person to hold the licence and for that purpose the applicant must provide such evidence and undergo such examinations and tests and undertake such courses of training as the Governor may require.

(2) The Governor must not grant such a licence to any person under the age of 18 years.

(3) The holder of a flight information service officer's licence must not provide a flight information service at an aerodrome unless that aerodrome has been specified in the licence by a person authorised by the Governor for the purpose and the licence has been validated in respect of that aerodrome by a person authorised for the purpose by the Governor.

(4) If, throughout any period of 90 days, the holder of the licence has not at any time provided such a service at a particular aerodrome the licence ceases to be valid for that aerodrome at the end of that period until the licence has been revalidated in respect of that aerodrome by a person authorised by the Governor for the purpose.

(5) A licence to act as a flight information service officer is not valid unless the holder of the licence has signed it in ink.

(6) Every holder of a flight information service officer's licence must upon such occasions as the Governor may require, submit to such examinations and tests and provide such evidence as to knowledge, experience, competence and skill and undergo such courses of training as the Governor may require.

### **Flight information service manual**

**152.** A person must not provide a flight information service at any aerodrome unless—

- (a) the service is provided in accordance with the standards and procedures specified in a flight information service manual in respect of that aerodrome;
- (b) the manual is produced to the Governor within a reasonable time after a request for its production is made by the Governor; and
- (c) such amendments or additions have been made to the manual as the Governor may from time to time require.

## PART 18

### AERONAUTICAL TELECOMMUNICATIONS SERVICE

#### **Aeronautical telecommunications service**

**153.**—(1) A person must not cause or permit any aeronautical telecommunication service to be established in any Territory otherwise than under and in accordance with an approval granted by the Governor to the person in charge of that aeronautical telecommunication service.

(2) The Governor must grant an approval under paragraph (1) upon being satisfied that the specified requirements are met, in particular—

- (a) as to the intended purpose of the aeronautical telecommunication service;
- (b) that the aeronautical telecommunication service is fit for its intended purpose; and
- (c) that the person is competent to provide the aeronautical telecommunication service.

(3) Any organisation providing a flight checking service in connection with an aeronautical telecommunication system or equipment must be approved by the Governor.

(4) An approval granted under paragraph (1) may include a condition requiring the person in charge of the aeronautical telecommunication service to use a person approved by the Governor under paragraph (5) for the provision of particular services in connection with the aeronautical telecommunication service.

(5) The Governor may approve a person to provide particular services in connection with an approved aeronautical telecommunication service.

(6) The provisions of this article do not apply in respect of any aeronautical telecommunication service of which the person solely in charge is the Governor or which is provided at a military aerodrome.

#### **Aeronautical telecommunication service records**

**154.**—(1) The person in charge of an aeronautical telecommunication service must provide recording equipment or apparatus in accordance with paragraph (2).

(2) The person in charge of the aeronautical telecommunication service in respect of which recording equipment or apparatus is required to be provided under paragraph (1) must ensure—

- (a) that the equipment or apparatus is in operation at all times when the aeronautical telecommunication service is being used in connection with the provision of a service provided for the purpose of facilitating the navigation of aircraft;
- (b) that the equipment or apparatus and each record made by the equipment or apparatus complies with the specified requirements.

(3) If any equipment or apparatus required under paragraph (1) ceases to be capable of recording the matters required to be included in the records, the person required to provide that equipment or apparatus must ensure that, so far as practicable, a record is kept which complies with the specified requirements and on which the specified particulars are recorded together with, in the case of equipment or apparatus provided in compliance with paragraph (2), a summary of voice communications exchanged between the air traffic control service and any aircraft.

(4) The person in charge of any aeronautical telecommunication service must preserve any record made using the equipment or apparatus provided under paragraph (1) for 30 days from the date on which the terms or content of the message or signal were recorded or for such longer period as the Governor may in a particular case direct.

(5) A person required by this article to preserve any record by reason of being the person in charge of the aeronautical telecommunication service must, if ceasing to be in charge, continue to preserve the record in accordance with paragraph (4).

(6) The provisions of this article do not apply in respect of any aeronautical telecommunication service that is under the control of Her Majesty's naval, military or air force or of any visiting force.

## PART 19

### AERODROMES, AERONAUTICAL LIGHTS AND DANGEROUS LIGHTS

#### Certification of aerodromes

**155.**—(1) A person in charge of the operation of an aerodrome in the Territory, other than a military aerodrome, is required to hold in respect of such aerodrome a certificate issued by the Governor in accordance with this article if—

- (a) the aerodrome is made available for any of the categories of operations referred to in article 156(3) of this Order; or
- (b) the Governor considers that it is in the public interest to require an aerodrome to be so certificated, taking into account only the matters referred to in paragraph (2).

(2) The Governor must grant a certificate in respect of any aerodrome in the Territory (an “aerodrome certificate”) upon being satisfied that—

- (a) the applicant meets the specified requirements and is competent to secure that the aerodrome and the airspace within which its visual traffic pattern is normally contained are suitable for use by aircraft;
- (b) the aerodrome is safe for use by aircraft having regard in particular to the physical characteristics of the aerodrome and of its surroundings;
- (c) the applicant has established an effective safety management system appropriate to the size and complexity of the operation; and
- (d) the applicant has established an aerodrome manual that is adequate and appropriate.

(3) The Governor may grant an aerodrome certificate which, in addition to any other conditions that may be imposed, may include a condition that the aerodrome shall at all times when it is available for the take-off or landing of aircraft be so available to all persons on equal terms and conditions.

(4) The holder of an aerodrome certificate granted under paragraph (2) or paragraph (3) (in this article called “an aerodrome certificate holder”) must—

- (a) provide to any person on request information concerning the terms of the certificate; and
- (b) cause to be notified the times during which the aerodrome will be available for the take-off or landing of aircraft.

(5) An aerodrome certificate holder must not contravene or cause or permit to be contravened any condition of the aerodrome certificate at any time in relation to such aircraft engaged on such flights as are referred to in article 156(3), but the certificate does not cease to be valid by reason only of such a contravention.

(6) An aerodrome certificate holder must take all reasonable steps to ensure that the aerodrome and the airspace within which its visual traffic pattern is normally contained are safe at all times for use by aircraft.

(7) For the purposes of this article “visual traffic pattern” means the aerodrome traffic zone of the aerodrome, or, in the case of an aerodrome which is not notified for the purposes of rule 45 of the

Rules of the Air, the airspace which would comprise the aerodrome traffic zone of the aerodrome if it was so notified.

### **Use of aerodromes and operating sites**

**156.**—(1) The Governor may cause to be notified any military aerodrome as an aerodrome available for the take-off and landing of aircraft engaged on flights in any of the categories referred to in paragraph (3) of this article.

(2) An aircraft to which paragraph (3) applies must not take off or land at a place in the Territory other than—

- (a) an aerodrome certificated under article 155 for the take-off and landing of such aircraft; or
- (b) a military aerodrome notified under paragraph (1) as available for the take-off and landing of such aircraft, or in respect of which the person in charge of the aerodrome has given permission for the particular aircraft to take off or land as the case may be;

and in accordance with any conditions subject to which the aerodrome may have been certificated or notified, or subject to which such permission may have been given.

(3) Paragraph (2) applies to—

- (a) aircraft which are flying for the purpose of international operations;
- (b) aircraft having a maximum approved passenger seating configuration of more than 9 which are flying for the purpose of commercial air transport operations; and
- (c) aircraft having a certificated take-off mass exceeding 15,000 kg operating a flight for the purpose of commercial air transport.

(4) Paragraph (2) does not apply to or in relation to an aircraft flying under and in accordance with the terms of a police air operator's certificate.

(5) The Governor may direct the operator of an aerodrome in the Territory that is not certificated under article 155 to make available at the aerodrome such rescue and fire fighting services as maybe specified, having regard to the nature and scope of the aircraft operations undertaken at the aerodrome.

(6) The person in charge of any place in the Territory intended to be used for the taking off or landing of helicopters at night must cause to be in operation, whenever a helicopter flying for the purpose of the commercial air transport of passengers is taking off or landing at that area by night, such lighting as will enable the pilot of the helicopter—

- (a) in the case of landing, to identify the landing area in flight, to determine the landing direction and to make a safe approach and landing; and
- (b) in the case of taking off, to make a safe take-off.

(7) For the purposes of paragraph (3)(a) “international operations” are operations in respect of which the point of departure of the flight and the point of its destination are in two different States or in respect of which the flight passes through the sovereign airspace of the territory of more than one State.

### **Instrument flight procedures**

**157.**—(1) No person may establish an instrument flight procedure at an aerodrome in the Territory except under and in accordance with an approval granted by the Governor to the aerodrome certificate holder or to the person having the management of the aerodrome.

(2) An approval must be granted under paragraph (1) upon the Governor being satisfied—

- (a) as to the intended purpose of the procedure;

- (b) that the person applying for approval is competent to operate the procedure;
  - (c) that any equipment associated with such procedure is fit for its intended purpose;
  - (d) that the procedure has been designed by a person approved under paragraph (5) according to the specified requirements and the conditions specified in that approval.
- (3) The aerodrome certificate holder or the person having the management of an aerodrome must cause an instrument flight procedure and its continuing status to be notified as a procedure available for the operation of aircraft at that aerodrome.
- (4) No person may use an instrument flight procedure otherwise than in accordance with the published conditions for such use.
- (5) The Governor may approve a person to design an instrument flight procedure for the purposes of paragraph 2(d) upon being satisfied that the person meets the Governor's requirements.
- (6) This article does not apply to any military aerodrome in the Territory.

### **Charges at aerodromes certificated or licensed for public use**

**158.**—(1) The Governor may, in relation to any aerodrome for which a certificate in accordance with article 155 has been granted, or to such aerodromes generally or to any class thereof, prescribe the charges, or the maximum charges, which may be made for the use of the aerodrome and for any services performed at the aerodrome to or for aircraft, and may further prescribe the conditions to be observed in relation to those charges and the performance of those services.

(2) The operator of an aerodrome in relation to which the Governor has prescribed charges under paragraph (1) must not cause or permit any charges to be made except as may be prescribed, and must cause particulars of the prescribed charges to be kept exhibited at the aerodrome in such a place and manner as to be readily available for the information of any person affected by them.

(3) The operator of any aerodrome for which an aerodrome certificate or licence for public use has been granted must, when required by the Governor, provide to the Governor such particulars as may be required of the charges established by the operator for the use of the aerodrome or of any facilities provided at the aerodrome for the safety, efficiency or regularity of air navigation.

### **Use of aerodromes by aircraft of Contracting States**

**159.** The person in charge of any aerodrome in the Territory which is open to public use by aircraft registered in the Territory (or in the United Kingdom or another Territory) must cause the aerodrome, and all air navigation facilities provided at it, to be available for use by aircraft registered in other Contracting States on the same terms and conditions as for use by aircraft registered in the Territory.

### **Noise and vibration caused by aircraft on aerodromes**

**160.**—(1) The Governor may prescribe the conditions or circumstances under which noise and vibration may be caused by aircraft (including military aircraft) on certificated aerodromes, notified aerodromes or on aerodromes at which the manufacture, repair or maintenance of aircraft is being carried out.

- (2) Such conditions or circumstances may include—
- (a) an aircraft is taking off or landing;
  - (b) an aircraft is moving on the ground or water; or
  - (c) engines are being operated in the aircraft—
    - (i) for the purpose of ensuring their satisfactory performance;
    - (ii) for the purpose of bringing them to a proper temperature in preparation for, or at the end of, a flight; or

(iii) for the purpose of ensuring that the instruments, accessories or other components of the aircraft are in a satisfactory condition.

(3) Section 41(2) of the Act<sup>(11)</sup> applies to any such aerodrome.

### **Customs and Excise airports**

**161.**—(1) The Governor may by order designate any aerodrome to be a place for the landing or departure of aircraft for the purpose of the enactments for the time being in force relating to customs and excise.

(2) The Governor may by order revoke any designation so made.

### **Aviation fuel at aerodromes**

**162.**—(1) A person who has the management of any aviation fuel installation on an aerodrome in the Territory must not cause or permit any fuel to be delivered to that installation or from it to an aircraft unless—

- (a) when the aviation fuel is delivered into the installation that person is satisfied that—
  - (i) the installation is capable of storing and dispensing the fuel so as not to render it unfit for use in aircraft;
  - (ii) the installation is marked in a manner appropriate to the grade of fuel stored or if different grades are stored in different parts each part is so marked; and
  - (iii) in the case of delivery into the installation or part thereof from a vehicle or vessel, the fuel has been sampled and is of a grade appropriate to that installation or that part of the installation as the case may be and is fit for use in aircraft; and
- (b) when any aviation fuel is dispensed from the installation that person is satisfied as the result of sampling that the fuel is fit for use in aircraft.

(2) Paragraph (1) does not apply to fuel that has been removed from an aircraft and is intended for use in another aircraft operated by the same operator as the aircraft from which it has been removed.

(3) A person to whom paragraph (1) applies must keep a written record for each installation of which that person has the management, which record must include—

- (a) particulars of the grade and quantity of aviation fuel delivered and the date of delivery;
- (b) particulars of all samples taken of the aviation fuel and of the results of tests of those samples; and
- (c) particulars of the maintenance and cleaning of the installation;

and the written record must be preserved for a period of 12 months or such longer period as the Governor may in a particular case direct and must, within a reasonable time after being requested to do so by an authorised person, be produced to that person.

(4) A person must not cause or permit any aviation fuel to be dispensed for use in an aircraft if that person knows or has reason to believe that the aviation fuel is not fit for use in aircraft.

(5) If it appears to the Governor or an authorised person that any aviation fuel is intended or likely to be delivered in contravention of any provision of this article, the Governor or that authorised person may direct the person having the management of the installation not to permit aviation fuel to be dispensed from that installation until the direction has been revoked by the Governor or by an authorised person.

(6) In this article—

---

<sup>(11)</sup> Section 41(2) is extended to the Territory by Schedule 2 to the Civil Aviation Act 1949 (Overseas Territories) Order 1969 (S.I. 1969/592).

“aviation fuel” means fuel intended for use in aircraft; and

“aviation fuel installation” means any apparatus or container, including a vehicle designed, manufactured or adapted for the storage of aviation fuel or for the delivery of such fuel to an aircraft.

### **Aeronautical lights**

**163.**—(1) A person must not, except with the permission of the Governor and in accordance with any conditions subject to which the permission may be granted, establish, maintain or alter the character of—

- (a) an aeronautical beacon within the Territory;
- (b) any aeronautical ground light (other than an aeronautical beacon) at an aerodrome certificated under this Order or under regulations made under this Order, or which forms part of the lighting system for use by aircraft taking off from or landing at an aerodrome.

(2) In the case of an aeronautical beacon that is or may be visible from the waters within an area of a general lighthouse authority, the Governor must not give his permission for the purpose of this article except with the consent of that authority.

(3) A person must not intentionally or negligently interfere with any aeronautical ground light established by or with the permission of the Governor.

### **Lighting of en-route obstacles**

**164.**—(1) For the purposes of this article an en-route obstacle means any building, structure or erection which is 150 metres or more above ground level other than any such building, structure or erection which is in the vicinity of a certificated or licensed aerodrome.

(2) The person in charge of an en-route obstacle must ensure that it is fitted with medium intensity steady red lights positioned as close as possible to the top of the obstacle and at intermediate levels spaced so far as practicable equally between the top lights and ground level with an interval not exceeding 52 metres.

(3) The person in charge of an en-route obstacle must ensure that, by night, the lights required to be fitted by this article are displayed.

(4) In the event of the failure of any light which is required by this article to be displayed by night the person in charge must repair or replace the light as soon as is reasonably practicable.

(5) At each level on the obstacle where lights are required to be fitted, sufficient lights must be fitted and arranged so as to show when displayed in all directions.

(6) In any particular case the Governor may direct that an en-route obstacle must be fitted with and display such additional lights in such positions and at such times as may be specified.

(7) This article does not apply to any en-route obstacle for which the Governor has granted permission to the person in charge.

(8) A permission may be granted for the purposes of this article in respect of a particular case or class of cases or generally.

### **Dangerous lights**

**165.**—(1) A person must not exhibit in the Territory any light which—

- (a) by reason of its glare is liable to endanger aircraft taking off from or landing at an aerodrome;
- (b) by reason of its liability to be mistaken for an aeronautical ground light is liable to endanger aircraft; or



(c) is directed or shone at any aircraft in flight so as to dazzle or distract the pilot of the aircraft.

(2) If any light which appears to the Governor to be a light referred to in paragraph (1)(a) and (b) is exhibited the Governor may cause a notice to be served upon the person who is the occupier of the place where the light is exhibited or has charge of the light, directing that person, within a reasonable time to be specified in the notice, to take such steps as may be specified in the notice for extinguishing or screening the light and for preventing for the future the exhibition of any other light which may similarly endanger aircraft.

(3) The notice may be served either personally or by post, or by affixing it in some conspicuous place near to the light to which it relates.

(4) In the case of a light that is or may be visible from any waters within the area of a general lighthouse authority, the power of the Governor under this article must not be exercised except with the consent of that authority.

## PART 20

### DOCUMENTS AND RECORDS

#### **Journey Log**

**166.**—(1) An operator of an aircraft used for the purposes of international air navigation must record and retain the information specified in instructions given by the Governor under article 74(1) in a journey log, in such form as is specified in those instructions.

(2) The Governor may permit an operator not to keep a journey log if the relevant information is available in other documents that are required to be kept under the provisions of this Order.

(3) An operator must ensure that all entries in a journey log are made concurrently and be permanent in nature.

#### **Documents to be carried**

**167.**—(1) An aircraft must not fly unless it carries the documents that it is required to carry under the law of the country in which it is registered.

(2) An aircraft registered in the Territory must, when in flight, carry the documents specified in instructions given by the Governor or identified in the specified requirements.

#### **Production of documents and records**

**168.**—(1) The pilot-in-command of an aircraft must, within a reasonable time after being requested to do so by an authorised person, cause to be produced to that person—

(a) the certificates of registration and airworthiness in force in respect of the aircraft;

(b) the licences of its flight crew; and

(c) such other documents as the aircraft is required by article 167 to carry when in flight.

(2) The operator of an aircraft registered in the Territory must, within a reasonable time after being requested to do so by an authorised person, cause to be produced to that person such of the following documents or records as may have been requested by that person being documents or records which are required, by or under this Order, to be in force or to be carried, preserved or made available—

(a) the certificate of airworthiness and certificate of registration in respect of the aircraft and the licence in force in respect of the aircraft radio station installed in the aircraft;

- (b) the aircraft log book, engine log books and variable pitch propeller log books required under this Order to be kept;
- (c) the weight schedule, if any, required to be preserved under article 38;
- (d) in the case of a commercial air transport aircraft or aerial work aircraft, a copy of the load sheet, the technical log and those parts of the operations manual required to be carried on the flight under article 96(2)(c);
- (e) any record which is required by article 62(6) to be preserved, and such other documents and information in the possession or control of the operator, as the authorised person may require for the purpose of determining whether those records are complete and accurate; and
- (f) the record made by any flight data recorder required to be carried by or under this Order.

(3) The holder of a licence granted or rendered valid under this Order or of a medical certificate required under article 54 must, within a reasonable time after being requested to do so by an authorised person, cause to be produced to that person the licence, including any certificate of validation.

(4) Every person required by article 58 to keep a personal flying log book must cause it to be produced within a reasonable time to an authorised person after being requested to do so, within 2 years after the date of the last entry in it.

#### **Production of aeronautical telecommunication service documents and records**

**169.** The holder of an approval under article 153 must within a reasonable time after being requested to do so by an authorised person, cause to be produced to that person any documents and records relating to any aeronautical telecommunication service used or intended to be used in connection with the provision of a service to an aircraft.

#### **Power to inspect and copy documents and records**

**170.** An authorised person has the power to inspect and copy any certificate, licence, log book, document or record that under this Order is required to be produced to that person.

#### **Preservation of documents, etc**

**171.—(1)** A person required by this Order to preserve any document or record by reason of being the operator of an aircraft must, if ceasing to be the operator of the aircraft, continue to preserve the document or record as if the person had not ceased to be the operator, and in the event of the person's death the duty to preserve the document or record falls upon the person's personal representative.

(2) If another person becomes the operator of the aircraft, the operator mentioned in paragraph (1) or the personal representative must deliver to that person upon demand the certificates of release to service, the log books and the weight schedule and any record made by a flight data recorder and preserved in accordance with article 84(3) which are in force or required to be preserved in respect of that aircraft.

(3) If an engine or variable pitch propeller is removed from the aircraft and installed in another aircraft operated by another person the operator mentioned in paragraph (1) or the personal representative must deliver to that person upon demand the logbook relating to that engine or propeller.

(4) If any person in respect of whom a record has been kept by the operator mentioned in paragraph (1) in accordance with article 62(6) becomes a member of the flight crew of a commercial air transport aircraft registered in the Territory and operated by another person the

operator mentioned in paragraph (1) or personal representative must deliver those records to that other person upon demand.

(5) It shall be the duty of the other person referred to in paragraphs (2), (3) and (4) to deal with the document or record delivered to as if the other person were the operator mentioned in paragraph (1).

### **Validity of certificates, licences, authorisations, approvals and permissions**

**172.** Wherever in this Order there is provision for the giving of an instruction or the issue or grant of a certificate, licence, authorisation, approval or permission by the Governor, unless otherwise provided, such an instruction or a certificate, licence, authorisation, approval or permission—

- (a) must be in writing;
- (b) may be issued or granted subject to such conditions as the Governor thinks fit;
- (c) may be issued or granted, subject to article 11, for such periods as the Governor thinks fit; and
- (d) may be renewed from time to time upon such conditions and for such further period or periods as the Governor thinks fit.

### **Offences in relation to documents and records**

**173.—**(1) A person must not with intent to deceive—

- (a) use any certificate, licence, approval, permission, exemption or other document issued or required by or under this Order which has been forged, altered, revoked or suspended, or to which the person is not entitled;
- (b) lend any certificate, licence, approval, permission, exemption or any other document issued or having effect or required by or under this Order to, or allow it to be used by, any other person; or
- (c) make any false representation for the purpose of procuring for himself, herself or any other person the grant, issue, renewal or variation of any such certificate, licence, approval, permission or exemption or other document;

and in this paragraph a reference to a certificate, licence, approval, permission, exemption or other document includes a copy or purported copy of it.

(2) A person must not intentionally damage, alter or render illegible any logbook or other record required by or under this Order to be maintained or any entry made in it, or knowingly make, or procure or assist in the making of, any false entry in or material omission from any such log book or record, or destroy any such log book or record during the period for which it is required under this Order to be preserved.

(3) All entries made in writing in any logbook or record referred to in paragraph (2) must be made in ink or other permanent form.

(4) A person must not knowingly make in a load sheet—

- (a) any entry that is incorrect in any material particular; or
- (b) any material omission.

(5) A person must not purport to issue any certificate for the purposes of this Order unless authorised to do so under this Order.

(6) A person must not issue any certificate for the purposes of this Order unless satisfied that all statements in the certificate are correct.

## PART 21

### OCCURRENCE REPORTING

#### **Mandatory occurrence reporting**

**174.**—(1) The objective of this article is to contribute to the improvement of air safety by ensuring that the relevant information on safety is reported, collected, stored, protected and disseminated.

(2) The sole objective of occurrence reporting is the prevention of accidents and incidents and not to attribute blame or liability.

(3) This article applies to occurrences that endanger or which, if not corrected, would endanger an aircraft, its occupants or any other person.

(4) Every person listed below must report to the Governor any event which constitutes a reportable occurrence for the purposes of paragraph (5) and which comes to that person's attention in the exercise of that person's functions—

- (a) the operator and the pilot-in-command of an aircraft which has a certificate of airworthiness or permit to fly issued by the Governor;
  - (b) the operator and the pilot-in-command of an aircraft operated under an air operator's certificate granted by the Governor;
  - (c) a person who carries on in the Territory the business of manufacturing, repairing or overhauling an aircraft referred to in sub-paragraphs (a) or (b), or any equipment or part thereof;
  - (d) a person who carries on the business of maintaining or modifying an aircraft that has a certificate of airworthiness or permit to fly issued by the Governor and a person who carries on the business of maintaining or modifying any equipment or part of such an aircraft;
  - (e) a person who carries on the business of maintaining or modifying an aircraft, operated under an air operator's certificate granted by the Governor, and a person who carries on the business of maintaining or modifying any equipment or part of such an aircraft;
  - (f) a person who signs an airworthiness report or a certificate of release to service in respect of such an aircraft, part or equipment;
  - (g) a person who performs a function which requires an air traffic controller's licence or flight information service authority;
  - (h) an aerodrome certificate holder, operator or manager of a certificated or licensed aerodrome;
  - (i) a person who performs a function connected with the installation, modification, maintenance, repair, overhaul, flight checking or inspection of air navigation facilities which are utilised by a person who provides an air traffic control service under an approval issued by the Governor;
  - (j) a person who performs a function concerning the ground-handling of aircraft, including fuelling, servicing, load sheet preparation, de-icing and towing.
- (5) In this article 'reportable occurrence' means—
- (a) any incident relating to an aircraft or any defect in or malfunctioning of an aircraft or any part or equipment of such an aircraft, being an incident, malfunctioning or defect endangering, or which if not corrected would endanger, the aircraft, its occupants or any other person; and
  - (b) any defect in or malfunctioning of any facility on the ground used or intended to be used for purposes of or in connection with the operation of an aircraft, being a defect or

malfunctioning endangering, or which if not corrected would endanger, an aircraft or its occupants.

(6) Any accident or serious incident notified to the Governor under regulations made under section 75 of the Act<sup>(12)</sup> does not constitute a reportable occurrence for purposes of this article.

(7) Reports of occurrences must be made within such time, by such means and contain such information as may be specified by the Governor in requirements published under article 5 and must be presented in such form as the Governor may in any particular case approve.

(8) Nothing in this article requires a person to report any occurrence which that person has reason to believe has been or will be reported by another person to the Governor in accordance with this article.

(9) A person must not make any report under this article knowing or having reason to believe that the report is false in any particular.

(10) If the operator of an aircraft has reason to believe that a report has been or will be made under this article, the operator must preserve any data from a flight data recorder or a combined cockpit voice recorder/flight data recorder relevant to the reportable occurrence for 14 days from the date on which a report of that occurrence is made to the Governor or for such longer period as the Governor may in a particular case direct.

(11) The record referred to in paragraph (10) may be erased if the aircraft is outside the Territory and it is not reasonably practicable to preserve the record until the aircraft reaches the Territory.

### **Mandatory reporting of bird strikes**

**175.**—(1) The pilot-in-command of an aircraft must make a report to the Governor of any bird strike occurrence which occurs whilst the aircraft is in flight within the Territory.

(2) The report must be made within such time, by such means and contain such information as may be specified by the Governor in requirements published under article 5 and be presented in such form as the Governor may in a particular case approve.

(3) Nothing in this article requires a person to report any occurrence which that person has reported under article 174 or has reason to believe has been or will be reported by another person to the Governor in accordance with that article.

(4) A person must not make any report under this article knowing or having reason to believe that the report is false in any particular.

(5) In this article “bird strike occurrence” means an incident in flight in which the pilot-in-command of an aircraft has reason to believe that the aircraft has been in collision with one or more than one bird.

## **PART 22**

### **PROHIBITED BEHAVIOUR, OFFENCES AND PENALTIES**

#### **Endangering safety of aircraft**

**176.** A person must not recklessly or negligently act in a manner likely to endanger an aircraft, or any person in the aircraft.

---

(12) Section 75 was extended to the Territory by the Civil Aviation Act 1982 (Overseas Territories) Order 2001 (S.I. 2001/3367).

### **Endangering safety of any person or property**

177. A person must not recklessly or negligently cause or permit an aircraft to endanger any person or property.

### **Drunkenness in aircraft**

178.—(1) A person must not enter any aircraft when drunk, or be drunk in any aircraft.

(2) A person must not, when acting as a member of the crew of any aircraft or being carried in any aircraft for the purpose of so acting, be under the influence of alcohol, any drug or any psychoactive substance, including prescribed or proprietary medication, so as to render that person's capacity so to act or so as to create a risk to that person or any other person.

### **Smoking in aircraft**

179. A person must not smoke in any compartment of an aircraft registered in the Territory at a time when smoking is prohibited in that compartment by a notice to that effect exhibited by or on behalf of the pilot-in-command of the aircraft.

### **Authority of pilot-in-command and members of the crew of an aircraft**

180.—(1) Every person in an aircraft must obey all lawful commands which the pilot-in-command or a member of the crew of that aircraft may give for the purpose of securing the safety of the aircraft and of the persons or property carried on board, or the safety, efficiency or regularity of air navigation.

(2) No person may operate on any aircraft any mobile or cell phone, computer or other electronic device that is designed to transmit or capable of transmitting electromagnetic energy otherwise than in accordance with the permission of the pilot-in-command of that aircraft.

(3) Paragraph (2) of this article does not apply to—

- (a) hearing aids;
- (b) heart pacemakers;
- (c) portable voice recorders;
- (d) electric shavers;
- (e) electronic watches;

or any other portable electronic device if the operator or pilot-in-command of the aircraft has determined that the said portable electronic device to be used will not cause interference with any aircraft system or equipment of the aircraft on which it is used.

### **Acting in a disruptive manner**

181. A person must not while in an aircraft—

- (a) use any threatening, abusive or insulting words towards a member of the crew of the aircraft;
- (b) behave in a threatening, abusive, insulting or disorderly manner towards a member of the crew of the aircraft; or
- (c) intentionally interfere with the performance by a member of the crew of the aircraft of his or her duties.

### **Obstruction of persons**

**182.** A person must not intentionally obstruct or impede any person acting in the exercise of powers or the performance of duties under this Order.

### **Enforcement of directions**

**183.** Any person who without reasonable excuse fails to comply with any direction or instructions given under any provision of this Order or any regulations made under it is deemed for the purposes of this Order to have contravened that provision.

### **Stowaways**

**184.** A person must not secrete himself or herself for the purpose of being carried in an aircraft without the consent of either the operator or the pilot-in-command or of any other person entitled to give consent to being carried in the aircraft.

### **Penalties**

**185.—(1)** If any provision of this Order or of any regulations made, direction or instructions given under it is contravened in relation to an aircraft, the operator of that aircraft and the pilot-in-command and, in the case of a contravention of articles 135 and 137, the charterer of that aircraft, is (without prejudice to the liability of any other person for that contravention) deemed for the purposes of the following provisions of this article to have contravened that provision unless they prove that the contravention occurred without their consent or connivance and that they exercised all due diligence to prevent the contravention.

(2) If it is proved that an act or omission of any person, which would otherwise have been a contravention by that person of a provision of this Order or of any regulations made under it, was due to any cause not avoidable by the exercise of reasonable care by that person, the act or omission is deemed not to be a contravention by that person of that provision.

(3) Where a person is charged with contravening a provision of this Order or of any regulations made under it by reason of having been a member of the flight crew of an aircraft on a flight for the purpose of commercial air transport or aerial work the flight is treated (without prejudice to the liability of any other person under this Order) as not having been for that purpose if the person proves that they did not know or suspect that the flight was for that purpose.

(4) Any person who contravenes any provision of this Order or of any regulations made under it not being a provision referred to in paragraphs (5) or (6), may be guilty of an offence and liable on summary conviction to a fine not exceeding £1000.

(5) Any person who contravenes any provision specified in Part A of Schedule 5 may be guilty of an offence and liable on summary conviction to a fine not exceeding £2500.

(6) Any person who contravenes any provision specified in Part B of Schedule 5 may be guilty of an offence and liable on summary conviction to a fine not exceeding £5000 and on conviction on indictment to a fine or imprisonment for a term not exceeding two years or both.

## PART 23

### APPLICABILITY AND GENERAL PROVISIONS

#### Flights over any foreign country

**186.**—(1) The operator and the pilot-in-command of an aircraft registered in the Territory (or, if the operator’s principal place of business or permanent residence is in the Territory, any other aircraft) which is being flown over any country other than the United Kingdom must not allow that aircraft to be used for a purpose which is prejudicial to the security, public order or public health of, or to the safety of air navigation in relation to, that country.

(2) A person does not contravene paragraph (1) if that person did not know or suspect that the aircraft was being or was to be used for a purpose referred to in paragraph (1).

(3) The operator and the pilot-in-command of an aircraft registered in the Territory (or, if the operator’s principal place of business or permanent residence is in the Territory, any other aircraft) which is being flown over any country other than the United Kingdom must comply with any directions given by the appropriate aeronautical authorities of that country whenever—

- (a) the flight has not been duly authorised; or
- (b) there are reasonable grounds for the appropriate aeronautical authorities to believe that the aircraft is being or will be used for a purpose which is prejudicial to the security, public order or public health of, or to the safety of air navigation in relation to, that country;

unless the lives of persons on board or the safety of the aircraft would be endangered as a result.

(4) A person does not contravene paragraph (3) if that person did not know or suspect that directions were being given by the appropriate aeronautical authorities.

(5) The requirement in paragraph (3) is without prejudice to any other requirement to comply with directions of an aeronautical authority.

(6) In this article “appropriate aeronautical authorities” includes any person, whether a member of a country’s military or civil authorities, authorised under the law of the foreign country to issue directions to aircraft flying over that country.

#### Application of Order

**187.** The provisions of this Order apply to the Territories mentioned in Schedule 6, any one of which is in this Order referred to in the expression “the Territory”.

#### Extra-territorial effect of the Order

**188.**—(1) Except where the context otherwise requires, the provisions of this Order—

- (a) insofar as they apply (whether by express reference or otherwise) to aircraft registered in the Territory, apply to such aircraft wherever they may be;
- (b) insofar as they apply to other aircraft, apply to such other aircraft when they are within the Territory or on, or in the neighbourhood of, an offshore installation;
- (c) insofar as they prohibit, require or regulate (whether by express reference or otherwise) the doing of anything by persons in, or by any of the crew of, any aircraft registered in the Territory, apply to such persons and crew wherever they may be; and
- (d) insofar as they prohibit, require or regulate the doing of anything in relation to any aircraft registered in the Territory by other persons, where such persons are Commonwealth citizens or British protected persons, apply to them wherever they may be.



(2) Nothing in this article is construed as extending to make any person guilty of an offence in any case in which it is provided by section 3(1) of the British Nationality Act 1948<sup>(13)</sup> (which limits the criminal liability of certain persons who are not citizens of the United Kingdom and colonies) that that person shall not be guilty of an offence.

#### **Application of the Order to Territory-controlled aircraft not registered in the Territory**

**189.**—(1) The Governor may direct that such of the provisions of this Order and of any regulations made or having effect under it as may be specified in the direction shall have effect as if reference in those provisions to aircraft registered in the Territory included references to the aircraft specified in the direction.

(2) A direction under paragraph (1) may only specify an aircraft that is not registered in the Territory but which is for the time being under the management of a person who (or of persons each of whom) is qualified to hold a legal or beneficial interest by way of ownership in an aircraft registered in the Territory.

#### **Application of the Order to the Crown and visiting forces etc.**

**190.**—(1) Subject to the following provisions of this article, the provisions of this Order apply to or in relation to aircraft belonging to or exclusively employed in the service of Her Majesty as they apply to or in relation to other aircraft.

(2) For the purposes of such application, the Department or other authority for the time being responsible on behalf of Her Majesty for the management of the aircraft is deemed to be the operator of the aircraft and, in the case of an aircraft belonging to Her Majesty, to be the owner of the interest of Her Majesty in the aircraft.

(3) Nothing in this article renders liable to any penalty any department or other authority responsible on behalf of Her Majesty for the management of any aircraft.

(4) Paragraph (5) applies to the naval, military and air force authorities and members of any visiting force and any international headquarters and the members thereof and property held or used for the purpose of such a force or headquarters

(5) Except as otherwise expressly provided, each body and person and any property to which paragraph (4) applies is exempt from the provisions of this Order and of any regulations made under it to the same extent as if it formed part of the forces of Her Majesty raised in the United Kingdom and for the time being serving in the Territory.

(6) Except as otherwise provided by paragraph (7), articles 61(3)(a), 69(7), (13) and (14), and 160 and the Rules of the Air, nothing in this Order applies to or in relation to any military aircraft.

(7) Where a military aircraft is flown by a civilian pilot and is not commanded by a person who is acting in the course of his or her duty as a member of any of Her Majesty's naval, military or air forces or as a member of a visiting force or international headquarters, articles 68, 176, 177, and 178 and the Rules of the Air apply unless, in the case of the Rules of the Air, an aircraft is flown in compliance with Military Flying Regulations or Flying Orders to Contractors issued by the Secretary of State.

#### **Exceptions for certain classes of aircraft**

**191.** Other than articles 3(1) and (4), 8(1)(b), 68(1), 70, 71, 73, 127, 128 and 177, this Order does not apply to or in relation to—

- (a) any small balloon;

---

<sup>(13)</sup> 1948 c.56. Section 3 was amended by section 314(2) of, and paragraph 22 of Schedule 13 to, the [Merchant Shipping Act 1995 \(c. 21\)](#) and by section 52(6) of, and Schedule 7 to, the [British Nationality Act 1981 \(c. 61\)](#).

- (b) any kite weighing not more than 2 kg;
- (c) any small unmanned aircraft; or
- (d) any parachute, including a parascending parachute.

#### **Approval for persons to furnish reports**

**192.** The Governor may approve a person as qualified to provide reports, and may accept such reports, in relation to any of the Governor's functions under any of the provisions of this Order.

#### **Appeal to Supreme Court**

**193.—(1)** An appeal lies to the Supreme Court or to such other court as may be prescribed from any decision of the Governor that a person is not a fit person to hold a licence to act as an aircraft maintenance engineer, member of the flight crew of an aircraft, air traffic controller, student air traffic controller or aerodrome flight information service officer, and if the court is satisfied that on the evidence submitted that the Governor was wrong in so deciding, the court may reverse the Governor's decision and the Governor must give effect to the court's determination.

(2) An appeal does not lie from a decision of the Governor that a person is not qualified to hold the licence by reason of a deficiency in that person's knowledge, experience, competence, skill, physical or mental fitness.

(3) The respondent to any appeal under this article shall be the Attorney General or other principal legal officer of the Government of the Territory.

(4) For the purposes of any provision relating to the time within which an appeal may be brought, the Governor's decision is deemed to have been taken on the date on which the Governor provided a statement of reasons for the decision to the applicant for the licence, or as the case may be, the holder or former holder of it.

#### **Saving**

**194.—(1)** Subject to the provisions of articles 155 and 159, nothing in this Order or any regulations made under it confers any right to land in any place as against the owner of the land or other persons interested in the land.

(2) Nothing in this Order obliges the Governor to accept an application from the holder of any current certificate, licence, approval, permission, exemption or other document, being an application for the renewal of that document, or for the granting of another document in continuation of or in substitution for the current document, if the application is made more than 60 days before the current document is due to expire.

## **PART 24**

### **INTERPRETATION OF COMMERCIAL AIR TRANSPORT**

#### **Commercial air transport – general rules**

**195.—(1)** For the purposes of this Order, an aircraft in flight is deemed to fly for the purposes of commercial air transport—

- (a) if valuable consideration is given or promised for the carriage of passengers or cargo in the aircraft on that flight;
- (b) if any passengers or cargo are carried gratuitously in the aircraft on that flight by an air transport undertaking, not being persons in the employment of the undertaking (including,

in the case of a body corporate, its directors) and persons with the authority of the Governor who are either making any inspection or witnessing any training, practice or test for the purposes of this Order, or cargo intended to be used by any such passengers as aforesaid, or by the undertaking; or

- (c) for the purposes of Part 3 (other than for articles 35(2) and 36(2)), if valuable consideration is given or promised for the primary purpose of conferring on a particular person the right to fly the aircraft on that flight (not being a single-seat aircraft of which the maximum total weight authorised does not exceed 910kg) otherwise than under a hire-purchase or conditional sale agreement.

(2) Notwithstanding that an aircraft may be flying for the purpose of commercial air transport by reason only of paragraph (1)(c), it is not deemed to be flying for the purpose of the commercial air transport of passengers unless valuable consideration is given for the carriage of those passengers.

(3) A glider is not deemed to fly for the purpose of commercial air transport for the purposes of Part 3 by virtue of paragraph (1)(c) if the valuable consideration given or promised for the primary purpose of conferring on a particular person the right to fly the glider on that flight is given or promised by a member of a flying club and the glider is owned or operated by that flying club.

(4) Notwithstanding the giving or promising of valuable consideration specified in sub-paragraph (1)(c) in respect of the flight or the purpose of the flight it shall—

- (a) subject to sub-paragraph (b), for all purposes other than Part 3; and
- (b) for the purposes of articles 35(2) and 36(2);

be deemed to be a private flight.

(5) Where a person is carried in or is given the right to fly an aircraft under a transaction effected by or on behalf of a member of an association of persons on the one hand and the association of persons or any member thereof on the other hand, in such circumstances that valuable consideration would be given or promised if the transaction were effected differently, valuable consideration is, for the purposes of this Part, deemed to have been given or promised, notwithstanding any rule of law as to such transactions.

(6) For the purposes of paragraph (1)(a), there shall be disregarded any valuable consideration given or promised in respect of a flight or the purpose of a flight by one company to another company which is—

- (a) its holding company;
- (b) its subsidiary; or
- (c) another subsidiary of the same holding company.

(7) For the purposes of this article a company is a “subsidiary” of another company, its “holding company”, if that other company—

- (a) holds a majority of the voting rights in it; or
- (b) is a member of it and has the right to appoint or remove a majority of its board of directors; or
- (c) is a member of it and controls alone, pursuant to an agreement with other members, a majority of the voting rights in it, or
- (d) if it is a subsidiary of a company that is itself a subsidiary of that other company.

#### **Commercial air transport – exception for flying displays etc.**

**196.**—(1) For the purposes of Part 4 of this Order, a flight is deemed to be a private flight if—

- (a) the flight is—

- (i) wholly or principally for the purpose of taking part in an aircraft race, contest or flying display;
  - (ii) for the purpose of positioning the aircraft for such a flight as is specified in sub-paragraph (i) and is made with the intention of carrying out such a flight; or
  - (iii) for the purpose of returning after such a flight as is specified in sub-paragraph (i) to a place at which the aircraft is usually based; and
- (b) the only valuable consideration in respect of the flight or the purpose of the flight other than—
- (i) valuable consideration specified at article 195(1)(c); or
  - (ii) in the case of an aircraft jointly owned in accordance with article 200(2), valuable consideration which falls within article 200(3);
- falls within paragraph (2)(a) or (2)(b) or both.
- (2) Valuable consideration falls within this paragraph if it either is—
- (a) that given or promised to the owner or operator of an aircraft taking part in such a race, contest or flying display and such valuable consideration does not exceed the direct costs of the flight and a contribution to the annual costs of the aircraft which contribution shall bear no greater proportion to the total annual costs of the aircraft than the duration of the flight bears to the annual flying hours of the aircraft; or
  - (b) one or more prizes awarded to the pilot-in-command of an aircraft taking part in an aircraft race or contest to a value which shall not exceed £500 in respect of any one race or contest except with the permission in writing of the Governor granted to the organiser of the race or contest which permission may be granted subject to such conditions as the Governor thinks fit.
- (3) Any prize falling within paragraph (2)(b) shall be deemed for the purposes of this Order not to constitute remuneration for services as a pilot.

#### **Commercial air transport – exception for charity flights**

**197.**—(1) A flight is deemed to be a private flight if the only valuable consideration given or promised in respect of the flight or the purpose of the flight other than—

- (a) valuable consideration specified at article 195(1)(c); or
- (b) in the case of an aircraft owned in accordance with article 200(2), valuable consideration which falls within article 200(3);

is given or promised to a registered charity which is not the operator of the aircraft and the flight is made with the permission in writing of the Governor and in accordance with any conditions therein specified.

(2) If valuable consideration specified at article 195(1)(c) is given or promised the flight is, for the purposes of Part 3 of this order (other than for articles 35(2) and 36(2)), deemed to be for the purposes of commercial air transport.

#### **Commercial air transport – exception for cost sharing**

**198.**—(1) A flight is deemed to be a private flight if the only valuable consideration given or promised in respect of the flight or the purpose of the flight falls within paragraph (2) and the criteria in paragraph (3) are satisfied.

- (2) Valuable consideration falls within this paragraph if it is—
  - (a) valuable consideration specified at article 195(1)(c);

- (b) in the case of an aircraft owned in accordance with article 200(2), valuable consideration which falls within article 200(3); or
  - (c) a contribution to the direct costs of the flight otherwise payable by the pilot-in-command.
- (3) The criteria in this paragraph are satisfied if—
- (a) no more than 4 persons (including the pilot) are carried on such a flight;
  - (b) the proportion which the contribution referred to in paragraph (2)(c) bears to the total direct costs of the flight shall not exceed the proportion which the number of persons carried on the flight (excluding the pilot) bears to the number of persons carried on the flight (including the pilot);
  - (c) no information concerning the flight has been published or advertised prior to the commencement of the flight other than, in the case of an aircraft operated by a flying club, advertising wholly within the premises of such a flying club in which case all the persons carried on such a flight who are aged 18 years or over must be members of that flying club; and
  - (d) no person acting as a pilot on such a flight shall be employed as a pilot by or be a party to a contract for the provision of services as a pilot with the operator of the aircraft being flown on the flight.
- (4) If valuable consideration specified in article 195(1)(c) is given or promised the flight is, for the purposes of Part 3 of this Order (other than for articles 35(2) and 36(2)), deemed to be for the purposes of commercial air transport.

#### **Commercial air transport – exception for recovery of direct costs**

**199.**—(1) A flight is deemed to be a private flight if the only valuable consideration given or promised in respect of the flight or the purpose of the flight other than—

- (a) valuable consideration specified in article 195(1)(c); or
- (b) in the case of an aircraft owned in accordance with article 200(2), valuable consideration which fails within article 200(3);

is the payment of the whole or part of the direct costs otherwise payable by the pilot-in-command by or on behalf of the employer of the pilot-in-command, or by or on behalf of a body corporate of which the pilot-in-command is a director, provided that neither the pilot-in-command nor any other person who is carried is legally obliged, whether under a contract or otherwise, to be carried.

(2) If valuable consideration specified in article 195(1)(c) is given or promised the flight is, for the purposes of Part II of this Order (other than for articles 35(2) and 36(2)), deemed to be for the purposes of commercial air transport.

#### **Commercial air transport – exception for jointly owned aircraft**

**200.**—(1) A flight is deemed to be a private flight if the aircraft falls within paragraph (2) and the only valuable consideration given or promised in respect of the flight or the purpose of the flight falls within paragraph (3).

- (2) An aircraft falls within this paragraph if it is owned—
- (a) jointly by persons (each of whom is a natural person) who each hold not less than a 5% beneficial share and—
    - (i) the aircraft is registered in the names of all the joint owners; or
    - (ii) the aircraft is registered in the name or names of one or more of the joint owners as trustee or trustees for all the joint owners, and written notice has been given to

the Governor of the names of all the persons beneficially entitled to a share in the aircraft; or

- (b) by a company in the name of which the aircraft is registered and the registered shareholders of which (each of whom is a natural person) each hold not less than 5% of the shares in that company.
- (3) Valuable consideration falls within this paragraph if it is either—
  - (a) in respect of and is no greater than the direct costs of the flight and is given, or promised by one or more of the joint owners of the aircraft or registered shareholders of the company which owns the aircraft; or
  - (b) in respect of the annual costs and given by one or more of such joint owners or shareholders.

### **Commercial air transport and aerial work – carriage of persons**

**201.** A flight is an aerial work flight if it is a flight in respect of which valuable consideration has been given or promised for—

- (a) the conduct of an aerial work activity during which, excluding crew members, no more than six persons indispensable to that aerial work activity are carried in the aircraft; and
- (b) flights immediately before and after an aerial work activity, provided that such flights are connected with that aerial work activity and the persons carried are as specified in paragraph (a).

### **Commercial air transport and aerial work – parachuting**

**202.** Notwithstanding article 201, a flight is an aerial work flight if it is a flight in respect of which valuable consideration has been given or promised for—

- (a) the dropping of persons by parachute and which is made under and in accordance with the terms of a parachuting permission granted by the Governor under article 131; and
- (b) associated positioning and return flights on which the persons carried are those who may be carried on such a flight in accordance with the terms of a parachuting permission granted by the Governor under article 131.

*Richard Tilbrook*  
Clerk of the Privy Council

## SCHEDULES

### SCHEDULE 1

Article 2

#### ORDERS REVOKED

	References
The Air Navigation (Overseas Territories) Order 2007	<a href="#">S.I. 2007/3468</a>
The Air Navigation (Overseas Territories) (Amendment) Order 2008	<a href="#">S.I. 2008/3125</a>
The Air Navigation (Overseas Territories) (Amendment) Order 2011	<a href="#">S.I. 2011/237</a>

### SCHEDULE 2

Article 3(5)

#### CLASSIFICATION OF AIRCRAFT

Table of general classification of aircraft

Col. 1	Col. 2	Col. 3	Col. 4
Aircraft	Lighter than air aircraft	Non-power driven	Free Balloon Captive Balloon
		Power driven	Airship
		Non-power driven	Glider Kite
			Aeroplane (Landplane)

**Status:** This is the original version (as it was originally made). This item of legislation is currently only available in its original format.

Col. 1	Col. 2	Col. 3	Col. 4
	Heavier than air aircraft		Aeroplane (Seaplane)
			Aeroplane (Amphibian)
		Power driven (flying machines)	Aeroplane (Self-launching Motor Glider)
			Powered Lift (Tilt Rotor)
			Rotorcraft
			Helicopter
			Gyroplane

SCHEDULE 3

Article 51, 52, 53 and 56

LICENCES

*MINIMUM AGE, PERIOD OF VALIDITY, PRIVILEGES*

*AEROPLANE PILOTS*

**Private Pilot’s Licence (Aeroplanes)**

*Minimum age – 17 years*

*No maximum period of validity*

*Privileges*

(1) Subject to paragraph (2), the holder of a Private Pilot’s Licence (Aeroplanes) is entitled to fly as pilot-in-command or co-pilot of an aeroplane of any of the types or classes specified or otherwise falling within an aircraft rating included in the licence.

(2) The holder of the licence must not—

- (a) fly an aeroplane for the purpose of commercial air transport or aerial work except in accordance with paragraph (3);
- (b) receive any remuneration for the holder’s services as a pilot on a flight except in accordance with paragraph (4);
- (c) unless the licence includes an instrument rating (aeroplanes), fly as pilot-in-command of an aeroplane—
  - (i) on a flight outside controlled airspace if the flight visibility is less than 3 km;
  - (ii) on a special VFR flight in a control zone in a flight visibility of less than 10 km except on a route or in an aerodrome traffic zone notified for the purpose of this subparagraph; or
  - (iii) when the surface is not in sight;
- (d) fly as pilot-in-command of an aeroplane at night unless the licence includes a night rating (aeroplanes);



- (e) unless the licence includes an instrument rating (aeroplanes), fly as pilot-in-command or co-pilot of an aeroplane flying in Class A, B, C, D or E airspace in circumstances which require compliance with the Instrument Flight Rules;
- (f) fly as pilot-in-command of an aeroplane carrying passengers unless—
  - (i) within the preceding 90 days the holder has made three take-offs and three landings as the sole manipulator of the controls of an aeroplane of the same type or class; and
  - (ii) if such a flight is to be carried out at night and the licence does not include an instrument rating (aeroplane) at least one of those take-offs and landings has been at night.
- (a) (3) (a) The holder may fly an aeroplane for the purpose of aerial work which consists of—
  - (i) the giving of instruction in flying, if the licence includes a flying instructor's rating; or
  - (ii) the conduct of flying tests for the purposes of this Order;
- (b) The holder may fly an aeroplane for the purpose of aerial work which consists of—
  - (i) towing a glider in flight; or
  - (ii) a flight for the purpose of dropping of persons by parachute;in either case in an aeroplane owned, or operated under arrangements entered into, by a flying club of which the holder of the licence and any person carried in the aircraft or in any glider towed by the aircraft are members.
- (4) The holder of a licence may receive remuneration for services as a pilot on a flight if—
  - (a) the licence includes a flying instructor's rating entitling the holder to give instruction in flying microlight aeroplanes; and
  - (b) the remuneration is for giving such instruction or conducting such flying tests as are specified in paragraph (3)(a) in a microlight aeroplane.

### **Commercial Pilot's Licence (Aeroplanes)**

*Minimum age – 18 years*

*Maximum period of validity – 10 years*

*Privileges:*

(1) The holder of a Commercial Pilot's Licence (Aeroplanes) is entitled to exercise the privileges of a Private Pilot's Licence (Aeroplanes) except that paragraphs 2(c) and (d) of those privileges do not apply.

(2) Subject to paragraphs (3) and (7), the holder is entitled to fly as pilot-in-command of an aeroplane of a type or class on which the holder is so qualified and which is specified in an aircraft rating included in the licence when the aeroplane is engaged on a flight for any purpose whatsoever.

- (3) The holder may not—
  - (a) unless the licence includes an instrument rating (aeroplanes), fly an aeroplane on any scheduled journey;
  - (b) fly as pilot-in-command of an aeroplane carrying passengers unless the holder has carried out at least three take-offs and three landings as pilot flying in an aeroplane of the same type or in a synthetic training device, approved for the purpose, of the aeroplane type to be used, in the preceding 90 days;
  - (c) as co-pilot serve at the flying controls in an aeroplane carrying passengers during take-off and landing unless the holder has served as a pilot at the controls during take-off and

*Status: This is the original version (as it was originally made). This item of legislation is currently only available in its original format.*

landing in an aeroplane of the same type or in a synthetic training device, approved for the purpose, of the aeroplane type to be used, in the preceding 90 days;

- (d) if the licence does not include a valid instrument rating (aeroplanes), act as pilot-in-command of an aeroplane carrying passengers at night unless during the previous 90 days at least one of the take-offs and landings required in sub-paragraph (b) has been at night;
- (e) unless the licence includes an instrument rating (aeroplanes), fly any aeroplane of which the maximum certificated take-off mass exceeds 2300 kg on any flight for the purpose of commercial air transport, except a flight beginning and ending at the same aerodrome and not extending beyond 25 nautical miles from that aerodrome;
- (f) fly as pilot-in-command of an aeroplane on a flight for the purpose of commercial air transport unless it is certificated for single pilot operation;
- (g) fly an aeroplane on any flight for the purpose of commercial air transport after attaining the age of 60 years unless the aeroplane is fitted with dual controls and carries a second pilot who has not attained the age of 60 years and who holds an appropriate licence under this Order entitling the second pilot to act as pilot-in-command or co-pilot of that aeroplane;
- (h) fly as pilot-in-command or co-pilot of an aeroplane flying in Class A, B or C airspace in circumstances which require compliance with the Instrument Flight Rules, unless the licence includes an instrument rating (aeroplanes).

(4) Subject to paragraph (5), the holder is entitled to fly as pilot-in-command of an aeroplane of a type specified in a flying instructor's rating included in the licence on a flight for the purpose of aerial work which consists of—

- (a) the giving of instruction in flying; or
- (b) the conducting of flying tests for the purposes of this Order;

in either case in an aeroplane owned, or operated under arrangements entered into, by a flying club of which the person giving the instruction or conducting the test and the person receiving the instruction or undergoing the test are both members.

(5) The holder is entitled to exercise privileges contained in paragraph (4) only in an aeroplane which the holder is entitled to fly as pilot-in-command on a private flight, an aerial work flight or a commercial air transport flight under the privileges set out in paragraph (1) or (2) of these privileges.

(6) The holder is entitled to fly as co-pilot of any aeroplane of a type specified in an aircraft rating included in the licence when the aeroplane is engaged on a flight for any purpose whatsoever.

(7) The holder must not at any time after attaining the age of 65 years act as pilot-in-command or co-pilot of any aeroplane on a flight for the purpose of commercial air transport.

### **Airline Transport Pilot's Licence (Aeroplanes)**

*Minimum age - 21 years*

*Maximum period of validity – 10 years*

*Privileges:*

The holder of an Air Transport Pilot's Licence is entitled to exercise the privileges of a Commercial Pilot's Licence (Aeroplanes) except that sub-paragraph (3)(f) of those privileges does not apply.

## *HELICOPTER AND GYROPLANE PILOTS*

### **Private Pilot's Licence (Helicopters)**

*Minimum age – 17 years*

*No maximum period of validity*

*Privileges:*

(1) Subject to paragraph (2), the holder of the licence is entitled to fly as pilot-in-command or co-pilot of any helicopter of a type specified in an aircraft rating included in the licence.

(2) The holder of the licence must not—

(a) fly a helicopter for the purpose of commercial air transport or aerial work other than aerial work which consists of—

(i) the giving of instruction in flying if the licence includes a flying instructor's rating;

(ii) the conduct of flying tests for the purposes of this Order;

except in either case in a helicopter owned, or operated under arrangements entered into, by a flying club of which the person giving the instruction or conducting the test and the person receiving the instruction or undergoing the test are both members;

(b) receive any remuneration for services as a pilot on a flight other than remuneration for the giving of such instruction or the conduct of such flying tests as are specified in subparagraph (a);

(c) fly as pilot-in-command of a helicopter at night unless the licence includes a night rating (helicopters);

(d) unless the licence includes an instrument rating (helicopter), fly as pilot-in-command or co-pilot of a helicopter in circumstances which require compliance with the Instrument Flight Rules—

(i) in Class A, B or C airspace at any time; or

(ii) in Class D, E, F or G airspace unless flying at night and remaining clear of cloud and with the surface in sight;

(e) fly as pilot-in-command of a helicopter carrying passengers unless—

(i) within the preceding 90 days the holder has made three circuits, each to include take-offs and landings as the sole manipulator of the controls of a helicopter of the same type; or

(ii) if the privileges are to be exercised by night and the licence does not include an instrument rating, within the preceding 90 days the holder has made three circuits, each to include take-offs and landings by night as the sole manipulator of the controls of a helicopter of the same type.

### **Private Pilot's Licence (Gyroplanes)**

*Minimum age – 17 years*

*No maximum period of validity*

*Privileges:*

(1) Subject to paragraph (2), the holder of a Private Pilot's Licence (Gyroplanes) is entitled to fly as pilot-in-command or co-pilot of any aeroplane of a type specified in the aircraft rating included in the licence.

(2) The holder of the licence may not fly a gyroplane for the purpose of commercial air transport or aerial work other than aerial work which consists of—

(a) the giving of instruction in flying if the licence includes a flying instructor's rating or an assistant flying instructor's rating; or

(b) the conduct of flying tests for the purposes of this Order;

*Status: This is the original version (as it was originally made). This item of legislation is currently only available in its original format.*

in either case in a gyroplane owned, or operated under arrangements entered into, by a flying club of which the person giving the instruction or conducting the test and the person receiving the instruction or undergoing the test are both members.

(3) The holder must not receive any remuneration for services as a pilot on a flight other than remuneration for giving of such instruction or the conduct of such flying tests as are specified in paragraph (2).

(4) The holder must not fly as pilot-in-command of a gyroplane at night unless the licence includes a night rating (gyroplanes) and the holder has within the immediately preceding 13 months carried out as pilot-in-command not less than 5 take-offs and five landings at a time when the depression of the centre of the sun was not less than 12° below the horizon.

### **Commercial Pilot's Licence (Helicopters and Gyroplanes)**

*Minimum age – 18 years*

*Maximum period of validity – 10 years*

*Privileges:*

- (1) Subject to paragraph (2), the holder of the licence is entitled—
  - (a) to exercise the privileges of a Private Pilot's Licence (Helicopters) or a Private Pilot's Licence (Gyroplanes) which includes respectively either a night rating (helicopters) or a night rating (gyroplanes); and
  - (b) to fly as pilot-in-command of any helicopter or gyroplane on which the holder is so qualified and which is of a type specified in an aircraft rating included in the licence when the helicopter or gyroplane is engaged on a flight for any purpose whatsoever.
- (2) The holder of the licence must not—
  - (a) fly a helicopter on a flight for the purpose of commercial air transport unless it is certificated for single pilot operation;
  - (b) fly a helicopter on any flight for the purpose of commercial air transport after attaining the age of 60 years unless the helicopter is fitted with dual controls and carries a second pilot who has not attained the age of 60 years and who holds an appropriate licence under this Order entitling the second pilot to act as pilot-in-command or co-pilot of that helicopter;
  - (c) unless the licence includes an instrument rating (helicopter), fly as pilot-in-command of a helicopter in circumstances which require compliance with the Instrument Flight Rules—
    - (i) in Class A, B or C airspace at any time; or
    - (ii) in Class D, E, F or G airspace unless remaining clear of cloud and with the surface in sight.
  - (d) fly as pilot-in-command of a helicopter carrying passengers unless the holder has carried out at least three circuits, each to include take-offs and landings, as pilot flying in a helicopter of the same type or a synthetic training device of the helicopter type to be used, in the preceding 90 days;
  - (e) unless the licence includes a valid instrument rating (helicopter) act as pilot-in-command of a helicopter carrying passengers at night unless during the previous 90 days at least one of the take-offs and landings required in sub-paragraph (aa) above has been carried out at night;
  - (f) fly a gyroplane on a flight for the purpose of commercial air transport unless it is certificated for single pilot operation;

**Status:** This is the original version (as it was originally made). This item of legislation is currently only available in its original format.

- (g) fly a gyroplane at night unless the holder has within the immediately preceding 13 months carried out as pilot-in-command not less than 5 take-offs and 5 landings at a time when the depression of the centre of the sun was not less than 12° below the horizon;
  - (h) fly a gyroplane on any flight for the purpose of commercial air transport after attaining the age of 60 years unless the gyroplane is fitted with dual controls and carries a second pilot who has not attained the age of 60 years and who holds an appropriate licence under this Order entitling the second pilot to act as pilot-in-command or co-pilot of that gyroplane.
  - (i)
    - (i) Subject to sub-paragraph (b) the holder is entitled to fly as co-pilot of any helicopter or gyroplane of a type specified in an aircraft rating included in the licence when the helicopter or gyroplane is engaged on a flight for any purpose whatsoever.
    - (ii) The holder may not, unless his licence includes an instrument rating (helicopter), fly as co-pilot of a helicopter flying in circumstances which require compliance with the Instrument Flight Rules—
      - (aa) in Class A, B or C airspace at any time; or
      - (bb) in Class D, E, F or G airspace unless remaining clear of cloud and with the surface in sight.
    - (iii) The holder may not as co-pilot serve at the flying controls in a helicopter carrying passengers during take-off and landing unless the holder has served as a pilot at the controls during take-off and landing in a helicopter of the same type or in a synthetic training device of the helicopter type to be used, in the preceding 90 days.
- (3) The holder must not at any time after attaining the age of 65 years act as pilot-in-command or co-pilot of any helicopter or gyroplane on a flight for the purpose of commercial air transport.

### **Airline Transport Pilot's Licence (Helicopters and Gyroplanes)**

*Minimum age – 21 years*

*Maximum period of validity – 10 years*

*Privileges:*

The holder of the licence is entitled to exercise the privileges of a Commercial Pilot's Licence (Helicopters and Gyroplanes) except that sub-paragraphs (2)(a) and (2)(f) of those privileges do not apply.

### *BALLOON AND AIRSHIP PILOTS*

### **Private Pilot's Licence (Balloons and Airships)**

*Minimum age – 17 years*

*No maximum period of validity*

*Privileges:*

(1) Subject to paragraph (2), the holder of a Private Pilot's Licence (Balloons and Airships) is entitled to fly as pilot-in-command of any type of balloon or airship on which the holder is so qualified and which is specified in an aircraft rating in the licence and co-pilot of any type of balloon or airship specified in such a rating.

(2) The holder may not—

- (a) fly a balloon or airship for the purpose of commercial air transport or aerial work, other than aerial work which consists of the giving of instruction in flying or testing in a club environment;

*Status: This is the original version (as it was originally made). This item of legislation is currently only available in its original format.*

- (b) receive any remuneration for services as a pilot on a flight other than remuneration for the giving of such instruction or the conducting of such flying tests as are specified in subparagraph (a); or
- (c) fly a balloon unless the holder has within the immediately preceding 13 months carried out as pilot-in-command in a free balloon five flights each of not less than five minutes duration.

### **Commercial Pilot's Licence (Balloons)**

*Minimum age – 18 years*

*Maximum period of validity – 10 Years*

*Privileges:*

(1) The holder of a Commercial Pilot's Licence (Balloons) is entitled to exercise the privileges of a Private Pilot's Licence (Balloons and Airships).

- (a) (2) (a) Subject to subparagraph (b), the holder is entitled to fly, when the balloon is flying for any purpose whatsoever, as pilot-in-command or co-pilot of any type of balloon specified in the aircraft rating included in the licence.
- (b) The holder may not act as pilot-in-command on a flight for the purpose of the commercial air transport of passengers unless the holder has within the immediately preceding 90 days carried out as pilot-in-command in a free balloon 3 flights each of not less than 5 minutes duration.

### **Commercial Pilot's Licence (Airships)**

*Minimum age – 18 years*

*Maximum period of validity – 10 years*

*Privileges:*

(1) The holder of a Commercial Pilot's Licence (Airships) is entitled to exercise the privileges of a Private Pilot's Licence (Balloons and Airships).

(2) The holder is entitled to fly, when the airship is flying for any purpose whatsoever, as pilot-in-command of any type of airship on which the holder is so qualified and which is specified in an aircraft rating included in the licence and as co-pilot of any type of airship specified in such a rating.

## *GLIDER PILOTS*

### **Commercial Pilot's Licence (Gliders)**

*Minimum age – 18 years*

*Maximum period of validity – 10 years*

*Privileges:*

The holder of a Commercial Pilot's Licence (Gliders) is entitled to fly for any purpose as pilot-in-command or co-pilot of—

- (a) any glider of which the maximum total weight authorised does not exceed 680 kg.
- (b) any glider of which the maximum total weight authorised exceeds 680 kg and which is of a type specified in the rating included in the licence.

## OTHER FLIGHT CREW

### **Flight Engineer's Licence**

*Minimum age – 21 years*

*Maximum period of validity – 10 years*

*Privileges:*

The holder of a Flight Engineer's Licence is entitled to act as flight engineer in any type of aircraft specified in an aircraft rating included in the licence.

### **Flight Radiotelephony Operator's Licence**

*Minimum age – 16 years*

*Maximum period of validity – 10 years*

*Privileges:*

The holder of a Radio Telephony Operator's Licence is entitled to operate radiotelephony apparatus in any aircraft if the stability of the frequency radiated by the transmitter is maintained automatically but is not be entitled to operate the transmitter, or to adjust its frequency, except by the use of external switching devices.

## SCHEDULE 4

Article 67

## RULES OF THE AIR

### SECTION 1

### INTERPRETATION

#### **Interpretation**

**1.** In these Rules—

“ACAS” means an aircraft system based on secondary surveillance radar (“SSR”) transponder signals which operates independently of ground based equipment to provide advice to the pilot on potential conflicting aircraft that are equipped with SSR transponders;

“air-taxiing” means flight by a helicopter, or other type of aircraft capable of vertical take-off and landing, above the surface of an aerodrome at a ground speed of less than 20 knots for the purpose of taxiing in accordance with normal aviation practice;

“air traffic control clearance” means an authorisation by an air traffic control unit for an aircraft to proceed under conditions specified by that unit;

“anti-collision light” means—

(a) in relation to rotorcraft, a flashing red light;

(b) in relation to any other aircraft, a flashing red or flashing white light;

in either case showing in all directions;

“Class C ATS route” means a route notified as such;

“day” means the time from half an hour before sunrise until half an hour after sunset (both times exclusive), sunset and sunrise being determined at surface level;

*Status: This is the original version (as it was originally made). This item of legislation is currently only available in its original format.*

“flight plan” means a plan containing such information as may be notified in respect of an air traffic control service unit, being information provided or to be provided to that unit which relates to an intended flight, or part of a flight, of an aircraft;

“ground visibility” means the horizontal visibility at ground level;

“IFR flight” means a flight conducted in accordance with the Instrument Flight Rules in Section 6 of these Rules;

“runway” means an area, whether or not paved, which is provided for the take-off or landing of aircraft;

“simulated instrument flight conditions” means a flight during which mechanical or optical devices are used in order to reduce the field of vision or the range of visibility from the cockpit of the aircraft;

“special VFR flight” means a flight—

- (a) made at any time in a control zone which is Class A airspace; or
- (b) made in any other control zone in either Instrument Meteorological Conditions or at night;
- (c) in respect of which the appropriate air traffic control unit has given permission for the flight to be made in accordance with special instructions given by that unit instead of in accordance with the Instrument Flight Rules; and
- (d) in the course of which the aircraft complies with any instructions given by that unit and the aircraft remains clear of cloud and with the surface in sight;

“VFR flight” means a flight conducted in accordance with the Visual Flight Rules in Section 5 of these Rules;

## SECTION 2

### GENERAL

#### **Application of Rules to aircraft**

2. These Rules, insofar as they apply to aircraft, apply—
  - (a) to all aircraft within the Territory; and
  - (b) for the purposes of Rule 5, to all aircraft in the neighbourhood of an offshore installation; and
  - (c) to all aircraft registered in the Territory, wherever they may be.

#### **Misuse of signals and markings**

3.—(1) A signal or marking which is given a meaning by Section 8 of these Rules or which is required by Section 8 to be used in specified circumstances or for a specified purpose must not be used except with that meaning, in those circumstances or for that purpose.

(2) A person in an aircraft or on an aerodrome or at any place at which an aircraft is taking off or landing must not—

- (a) make any signal which may be confused with a signal specified in Section 9; or
- (b) except with lawful authority, make any signal which he knows or ought reasonably to know to be a signal in use for signalling to or from any of Her Majesty’s naval, military or air force aircraft.



(3) Signals prescribed in accordance with general international aeronautical practice for the purposes of search and rescue must not be used for any purpose other than that intended.

### **Reporting hazardous conditions**

4.—(1) If any aircraft encounters hazardous conditions in the course of a flight, the pilot-in-command of the aircraft must send to the appropriate air traffic control unit, by the quickest means available, information containing such particulars of the hazardous conditions as may be pertinent to the safety of other aircraft.

(2) The information must be sent immediately the aircraft encounters the hazardous conditions or as soon as it is possible to do so afterwards.

## *SECTION 3*

### *LOW FLYING RULE*

### **Low flying prohibitions**

5.—(1) Subject to paragraph (2), an aircraft must comply with the low flying prohibitions in paragraph (3) unless exempted by rule 6.

(2) If an aircraft is flying in circumstances such that more than one of the low flying prohibitions applies, it must fly at the greatest height required by any of the applicable prohibitions.

(3) The low flying prohibitions are as follows—

(a) Engine failure

An aircraft must not be flown below such height as would enable it to make an emergency landing without causing danger to persons or property on the surface in the event of an engine failure.

(b) The 500 feet rule

Except with the written permission of the Governor, an aircraft must not be flown closer than 500 feet to any person, vessel, vehicle or structure.

(c) The 1,000 feet rule

Except with the written permission of the Governor, an aircraft flying over a congested area of a city, town or settlement must not fly below a height of 1,000 feet above the highest fixed obstacle within a horizontal radius of 600 metres of the aircraft.

(d) The land clear rule

An aircraft flying over a congested area of a city, town or settlement must not fly below such height as would permit the aircraft to land clear of the congested area in the event of an engine failure.

(e) Flying over open air assemblies

Except with the written permission of the Governor, an aircraft must not fly over an organised open-air assembly of more than 1,000 persons below whichever is the higher of the following heights—

(i) 1,000 feet; or

(ii) such height as would permit the aircraft to land clear of the assembly in the event of an engine failure.

(f) Landing and taking off near open air assemblies

*Status: This is the original version (as it was originally made). This item of legislation is currently only available in its original format.*

An aircraft must not land or take-off within 1,000 metres of an organised, open-air assembly of more than 1,000 persons except—

- (i) at an aerodrome, in accordance with procedures notified by the Governor; or
- (ii) at a landing site which is not an aerodrome, in accordance with procedures notified by the Governor and with the written permission of the organiser of the assembly.

### **Exemptions from the low flying prohibitions**

6. The exemptions from the low flying prohibitions are as follows—

(a) Landing and taking off

(i) An aircraft is exempt from the low flying prohibitions when it is flying in accordance with normal aviation practice for the purpose of—

(aa) taking off from, landing at or practising approaches to landing at; or

(bb) checking navigational aids or procedures at,

a certificated or notified aerodrome.

(ii) An aircraft is exempt from the 500 feet rule when landing and taking-off in accordance with normal aviation practice or air-taxiing.

(b) Captive balloons and kites

None of the low flying prohibitions apply to any captive balloon or kite.

(c) Special VFR flight and notified routes

(i) Subject to paragraph (ii), an aircraft is exempt from the 1,000 feet rule when—

(aa) it is flying on a special VFR flight; or

(bb) it is operating in accordance with the procedures notified for the route being flown.

(ii) Unless the written permission of the Governor has been obtained, landings may only be made by an aircraft flying under this exemption at a certificated or notified aerodrome.

(d) Balloons and helicopters over congested areas

(i) A balloon is exempt from the 1,000 feet rule if it is landing because it is becalmed.

(ii) Subject to rule 5(3)(a) a helicopter flying over a congested area is exempt from the land clear rule.

(e) Police air operator's certificate

An aircraft flying in accordance with the terms of a police air operator's certificate is exempt from the 500 feet rule, the 1,000 feet rule and the prohibitions on flying over open air assemblies and on landing and taking off near open air assemblies.

(f) Flying displays etc

An aircraft taking part in a flying display is exempt from the 500 feet rule when it is within a horizontal distance of 1,000 metres of the gathering of persons assembled to witness the event.

(g) Glider hill-soaring

A glider is exempt from the 500 feet rule if it is hill-soaring.

(h) Picking up and dropping at an aerodrome

An aircraft picking up or dropping tow ropes, banners or similar articles at an aerodrome is exempt from the 500 feet rule.

- (i) Manoeuvring helicopters
  - (i) Subject to paragraph (ii), a helicopter is exempt from the 500 feet rule if it is conducting manoeuvres, in accordance with normal aviation practice, within the boundaries of a certificated or military aerodrome or, with the written permission of the Governor at other sites.
  - (ii) When flying in accordance with this exemption the helicopter must not be operated closer than 60 metres to any persons, vessels, vehicles or structures located outside the aerodrome or site.
- (j) Dropping articles with the permission of the Governor

An aircraft is exempt from the 500 feet rule if it is flying in accordance with—

  - (i) article 130(3)(f) of this Order; or
  - (ii) an aerial application permission granted by the Governor under article 128 of this Order.

#### SECTION 4

#### GENERAL FLIGHT RULES

##### **Weather reports and forecasts**

7.—(1) Subject to paragraph (2), immediately before an aircraft flies the pilot-in-command of the aircraft must examine the current reports and forecasts of the weather conditions on the proposed flight path, in order to determine whether Instrument Meteorological Conditions prevail, or are likely to prevail, during any part of the flight.

(2) Paragraph (1) only applies if it is reasonably practicable for the pilot-in-command to obtain current reports and forecasts of the weather conditions on the proposed flight path.

(3) Subject to paragraph (4), an aircraft which is unable to communicate by radio with an air traffic control unit at the aerodrome of destination must not begin a flight to the aerodrome if—

- (a) the aerodrome is within a control zone; and
- (b) the weather reports and forecasts which it is reasonably practicable for the pilot-in-command of the aircraft to obtain indicate that it will arrive at that aerodrome when the ground visibility is less than 10 km or the cloud ceiling is less than 1,500 feet.

(4) Paragraph (3) does not apply if, before take-off, the pilot-in-command of the aircraft has obtained permission from the air traffic control unit at the aerodrome of destination to enter the aerodrome traffic zone.

##### **Avoiding aerial collisions**

8.—(1) Notwithstanding that a flight is being made with air traffic control clearance it remains the duty of the pilot-in-command of an aircraft to take all possible measures to ensure that the aircraft does not collide with any other aircraft.

(2) An aircraft must not be flown in such proximity to other aircraft as to create a danger of collision.

(3) Subject to paragraph (7), aircraft must not fly in formation unless the pilots-in-command of the aircraft have agreed to do so.

(4) An aircraft which is obliged by this Section to give way to another aircraft must avoid passing over or under the other aircraft, or crossing ahead of it, unless passing well clear of it.

*Status: This is the original version (as it was originally made). This item of legislation is currently only available in its original format.*

(5) Subject to paragraph (7), an aircraft which has the right-of-way under this rule must maintain its heading and speed.

(6) For the purposes of this rule a glider and a flying machine which is towing it are considered to be a single aircraft under the command of the pilot-in-command of the flying machine.

(7) Paragraphs (3) and (5) do not apply to an aircraft flying under and in accordance with the terms of a police air operator's certificate.

(8) Nothing in these Rules relieves the pilot-in-command of an aircraft from the responsibility of taking such action, including collision avoidance manoeuvres based on resolution advisories provided by ACAS equipment, as will best avert a collision.

### **Converging**

9.—(1) Subject to paragraphs (2) and (3) and to rules 10 and 11, aircraft in the air must give way to other, converging aircraft as follows—

- (a) flying machines must give way to airships, gliders and balloons;
- (b) airships must give way to gliders and balloons;
- (c) gliders must give way to balloons.

(2) Mechanically driven aircraft must give way to aircraft which are towing other aircraft or objects.

(3) Subject to paragraph (2), when two aircraft are converging in the air at approximately the same altitude, the aircraft which has the other on its right must give way.

### **Approaching head-on**

10. When two aircraft are approaching head-on, or approximately so, in the air and there is a danger of collision, each must alter its heading to the right.

### **Overtaking**

11.—(1) Subject to paragraph (3), an aircraft which is being overtaken in the air has the right-of-way and the overtaking aircraft, whether climbing, descending or in horizontal flight, must keep out of the way of the other aircraft by altering course to the right.

(2) An aircraft which is overtaking another aircraft must keep out of the way of the other aircraft until that other aircraft has been passed and is clear, notwithstanding any change in the relative positions of the two aircraft.

(3) A glider overtaking another glider in the Territory may alter its course to the right or to the left.

### **Flight in the vicinity of an aerodrome**

12.—(1) Subject to paragraph (2), a flying machine, glider or airship flying in the vicinity of what the pilot-in-command of the aircraft knows, or ought reasonably to know, to be an aerodrome must—

- (a) conform to the pattern of traffic formed by other aircraft intending to land at that aerodrome or keep clear of the airspace in which the pattern is formed; and
- (b) make all turns to the left unless ground signals otherwise indicate.

(2) Paragraph (1) does not apply if the air traffic control unit at that aerodrome authorises otherwise.

### **Order of landing**

**13.**—(1) An aircraft landing or on its final approach to land has the right-of-way over other aircraft in flight or on the ground or water.

(2) An aircraft must not cut in front of another aircraft on its final approach to land or overtake that aircraft.

(3) If an air traffic control unit has communicated to any aircraft an order of priority for landing, the aircraft must approach to land in that order.

(4) If the pilot-in-command of an aircraft is aware that another aircraft is making an emergency landing, that pilot must give way to that aircraft.

(5) If the pilot-in-command gives way in the circumstances referred to in paragraph (4) at night then, even if permission to land has previously been given, that pilot must not attempt to land until given further permission to do so.

(6) Subject to paragraphs (2), (3) and (4), if two or more flying machines, gliders or airships are approaching any place for the purpose of landing, the aircraft at the lower altitude has the right-of-way.

### **Landing and take-off**

**14.**—(1) A flying machine, glider or airship must take off and land in the direction indicated by the ground signals or, if no such signals are displayed, into the wind, unless good aviation practice demands otherwise.

(2) Subject to paragraph (5), a flying machine or glider must not land on a runway at an aerodrome if there are other aircraft on the runway.

(3) If take-offs and landings are not confined to a runway—

(a) when landing a flying machine or glider must leave clear on its left any aircraft which has landed, is already landing or is about to take off;

(b) a flying machine or glider which is about to turn must turn to the left after the pilot-in-command of the aircraft has satisfied himself that such action will not interfere with other traffic movements; and

(c) a flying machine which is about to take off must take up position and manoeuvre in such a way as to leave clear on its left any aircraft which has already taken off or is about to take off.

(4) Subject to paragraph (5) a flying machine must move clear of the landing area as soon as it is possible to do so after landing.

(5) Paragraphs (2) and (4) do not apply if the air traffic control unit at the aerodrome authorises the flying machine or glider otherwise.

### **Aerobatic manoeuvres**

**15.** An aircraft must not carry out any aerobatic manoeuvre—

(a) over the congested area of any city, town or settlement; or

(b) within controlled airspace except with the consent of the appropriate air traffic control unit.

### **Right-hand traffic rule**

**16.**—(1) Subject to paragraph (2), an aircraft which is flying within the Territory with the surface in sight and following a road, railway, canal or coastline, or any other line of landmarks, must keep them on its left.

*Status: This is the original version (as it was originally made). This item of legislation is currently only available in its original format.*

(2) Paragraph (1) does not apply to an aircraft flying within controlled airspace in accordance with instructions given by the appropriate air traffic control unit.

#### **Notification of arrival and departure**

**17.**—(1) If the pilot-in-command of an aircraft has caused notice of the intended arrival of the aircraft at an aerodrome to be given to the air traffic control unit or other authority at that aerodrome, that pilot must ensure that the unit or authority is informed as quickly as possible of—

- (a) any change of intended destination; and
- (b) any estimated delay in arrival of 45 minutes or more.

(2) The pilot-in-command of an aircraft arriving at or departing from an aerodrome in the Territory must take all reasonable steps to ensure, upon landing or prior to departure, as the case may be, that the person in charge of the aerodrome or the air traffic control unit or flight information service unit at the aerodrome is given notice of the landing or departure.

(3) A flight plan must be submitted prior to operating—

- (a) any flight within or into designated areas, or along designated routes, when so required by the appropriate aeronautical authorities; or
- (b) any flight across international borders.

#### **Flight in Class A airspace**

**18.**—(1) Subject to paragraphs (2) and (3), the pilot-in-command of an aircraft flying in Visual Meteorological Conditions in Class A airspace must comply with rules 35, 36 and 37 as if the flight were an IFR flight.

(2) For the purposes of paragraph (1) rule 36(2) does not apply.

(3) Paragraph (1) does not apply to the pilot-in-command of a glider which is flying in Class A airspace which is notified for the purpose of this paragraph if the glider is flown in accordance with such conditions as may also be notified for that purpose.

#### **Flight in Class C Airspace**

**19.**—(1) Subject to paragraphs (2) and (3) the pilot-in-command of an aircraft flying in Visual Meteorological Conditions in Class C airspace above flight level 195, or along a Class C ATS route at any level, must comply with rules 35, 36 and 37 as if the flight were an IFR flight.

(2) For the purposes of paragraph (1) rule 36(2) does not apply.

(3) Paragraph (1) does not apply to the pilot-in-command of an aircraft which is flying in accordance with an authorisation issued by the Governor.

#### **Choice of VFR or IFR**

**20.**—(1) Subject to paragraph (2), an aircraft must always be flown in accordance with the Visual Flight Rules or the Instrument Flight Rules.

(2) In the Territory an aircraft flying at night must—

- (a) be flown in accordance with the Instrument Flight Rules outside a control zone;
- (b) be flown in accordance with the Instrument Flight Rules in a control zone unless it is flying on a special VFR flight.

### **Speed limitations**

**21.**—(1) Subject to paragraph (2), an aircraft must not fly below flight level 100 at a speed which, according to its air speed indicator, is more than 250 knots.

(2) Paragraph (1) does not apply to—

- (a) flights in Class A airspace;
- (b) VFR flights or IFR flights in Class B airspace;
- (c) IFR flights in Class C airspace;
- (d) VFR flights in Class C airspace or VFR flights or IFR flights in Class D airspace when authorised by the appropriate air traffic control unit;
- (e) an aircraft taking part in a flying display for which a permission is required by article 69(1) of this Order, if the flight is made in accordance with the terms of the permission granted to the organiser of the flying display and in accordance with the conditions of the display authorisation granted to the pilot under article 69(8) of this Order;
- (f) an aircraft flying in accordance with a written permission granted by the Governor authorising the aircraft to exceed the speed limit in paragraph (1).

(3) The Governor may grant a permission for the purpose of paragraph (2)(f) either generally or in respect of any aircraft or class of aircraft.

### **Use of radio navigation aids**

**22.**—(1) Subject to paragraph (2), the pilot-in-command of an aircraft must not make use of any radio navigation aid without complying with such restrictions and procedures as may be notified in relation to that aid.

(2) The pilot-in-command of an aircraft is not required to comply with this rule if the pilot—

- (a) is required to comply with rules 35 and 36; or
- (b) is otherwise authorised by an air traffic control unit.

### **Simulated instrument flight**

**23.**—(1) An aircraft must not be flown in simulated instrument flight conditions unless the conditions in paragraph (2) are met.

(2) The conditions referred to in paragraph (1) are as follows—

- (a) fully functioning dual controls are installed in the aircraft;
- (b) a qualified pilot occupies a control seat to act as safety pilot for the person who is flying under simulated instrument conditions; and
- (c) if the safety pilot's field of vision is not adequate, a competent observer in communication with the safety pilot must occupy a position in the aircraft from which that person's field of vision adequately supplements that of the safety pilot.

### **Practice instrument approaches**

**24.**—(1) An aircraft must not carry out an instrument approach practice within the Territory if it is flying in Visual Meteorological Conditions unless the conditions in paragraph (2) are met.

(2) The conditions referred to in paragraph (1) are as follows—

- (a) the appropriate air traffic control unit has previously been informed that the flight is to be made for the purpose of instrument approach practice; and

*Status: This is the original version (as it was originally made). This item of legislation is currently only available in its original format.*

- (b) if the flight is not being carried out in simulated instrument flight conditions, a competent observer is carried in such a position in the aircraft that the observer has an adequate field of vision and can readily communicate with the pilot flying the aircraft.

## SECTION 5

### VISUAL FLIGHT RULES

#### Applicability of the Visual Flight Rules

- 25.—(1) Rules 27, 29 and 30 are the Visual Flight Rules which apply within controlled airspace.
- (2) Rule 28 is the Visual Flight Rule which applies outside controlled airspace.

#### Reported visibility

26. For the purposes of an aircraft taking off from or approaching to land at an aerodrome within Class B, Class C, or Class D airspace, the visibility, if any, communicated to the pilot-in-command of the aircraft by the appropriate air traffic control unit is deemed to be the flight visibility for the time being.

#### Flight within controlled airspace

- 27.—(1) Subject to paragraphs (2) and (3), an aircraft flying within Class B, Class C, Class D or Class E airspace—
  - (a) at or above flight level 100 must remain at least 1,500 metres horizontally and 1,000 feet vertically away from cloud and in a flight visibility of at least 8 km;
  - (b) below flight level 100 must remain at least 1,500 metres horizontally and 1,000 feet vertically away from cloud and in a flight visibility of at least 5 km.
- (2) An aircraft is deemed to have complied with paragraph (1)(b) if—
  - (a) the aircraft is not a helicopter and it—
    - (i) flies at or below 3,000 feet above mean sea level;
    - (ii) flies at a speed which, according to its airspeed indicator, is 140 knots or less; and
    - (iii) remains clear of cloud, with the surface in sight and in a flight visibility of at least 5 km; or
  - (b) the aircraft is a helicopter and it—
    - (i) flies at or below 3,000 feet above mean sea level; and
    - (ii) remains clear of cloud, with the surface in sight and in a flight visibility of at least 1,500 metres.
- (3) Paragraph (1) does not apply to a helicopter that is air-taxiing or conducting manoeuvres in accordance with rule 6(i).

#### Flight outside controlled airspace

- 28.—(1) An aircraft flying outside controlled airspace at or above flight level 100 must remain at least 1,500 metres horizontally and 1,000 feet vertically away from cloud and in a flight visibility of at least 8 km.
- (2) Subject to paragraphs (3), (4) and (5), an aircraft flying outside controlled airspace below flight level 100 must remain at least 1,500 metres horizontally and 1,000 feet vertically away from cloud and in a flight visibility of at least 5 km.



- (3) Paragraph (2) does not apply to an aircraft which—
  - (a) flies at or below 3,000 feet above mean sea level;
  - (b) remains clear of cloud with the surface in sight; and
  - (c) is in a flight visibility of at least 5 km.
- (4) Paragraph (2) does not apply to an aircraft which—
  - (a) flies at or below 3,000 feet above mean sea level;
  - (b) flies at a speed which, according to its air speed indicator, is 140 knots or less;
  - (c) remains clear of cloud with the surface in sight; and
  - (d) is in a flight visibility of at least 1,500 metres.
- (5) Paragraphs (1) and (2) do not apply to a helicopter which is air-taxiing or conducting manoeuvres in accordance with rule 6(i).

#### **VFR flight plan and air traffic control clearance in Class B, Class C or Class D airspace**

**29.**—(1) Subject to rule 31, before an aircraft flies within Class B, Class C or Class D airspace during the notified hours of watch of the appropriate air traffic control unit, the pilot-in-command of the aircraft must—

- (a) cause to be communicated to the appropriate air traffic control unit a flight plan which complies with paragraphs (2) and (3) (as appropriate); and
  - (b) obtain an air traffic control clearance to fly within that airspace.
- (2) The flight plan must contain such particulars of the flight as may be necessary to enable the air traffic control unit to issue a clearance and for search and rescue purposes.
- (3) The flight plan required for a flight within Territory with reduced vertical separation minimum airspace must also state whether or not the aircraft is equipped with height keeping systems, as required by articles 89, 90 or 91 of this Order.
- (4) The pilot-in-command of an aircraft must not cause a flight plan to be communicated to the appropriate air traffic control unit for VFR flight in Class C airspace above FL195 or along a Class C ATS route at any level unless authorised to do so by the Governor.

#### **Maintaining continuous watch and complying with air traffic control instructions**

**30.**—(1) Subject to rule 31, whilst flying within Class B, Class C or Class D airspace during the notified hours of watch of the appropriate air traffic control unit, the pilot-in-command of an aircraft must—

- (a) cause a continuous watch to be maintained on the notified radio frequency appropriate to the circumstances; and
- (b) comply with any instructions which the appropriate air traffic control unit may give.

#### **Exceptions to rules 29 and 30**

**31.**—(1) Rule 29 does not apply if the aircraft has been authorised otherwise by the appropriate air traffic control unit.

(2) Rules 29(1) and 30 do not apply to any glider flying or intending to fly in Class B airspace notified for the purpose of this paragraph.

- (3) Rules 29(1) and 30 do not apply to any glider which—
  - (a) flies during the day;
  - (b) is in controlled airspace notified for the purpose of this paragraph; and

*Status: This is the original version (as it was originally made). This item of legislation is currently only available in its original format.*

- (c) remains at least 1,500 metres horizontally and 1,000 feet vertically away from cloud and in a flight visibility of at least 8 km.
- (4) Rules 29(1) and 30 do not apply to any mechanically driven aircraft without radio equipment if—
  - (a) it flies during the day;
  - (b) it is in controlled airspace notified for the purpose of this paragraph;
  - (c) it remains at least 1,500 metres horizontally and 1,000 feet vertically away from cloud and in a flight visibility of at least 5 km; and
  - (d) its pilot-in-command has previously obtained the permission of the appropriate air traffic control unit to fly within the controlled airspace.

## SECTION 6

### INSTRUMENT FLIGHT RULES

#### Instrument Flight Rules

**32.**—(1) Rules 33 and 34 are the Instrument Flight Rules which apply both within and outside controlled airspace.

(2) Rules 35, 36 and 37 are the Instrument Flight Rules which apply outside controlled airspace.

#### Minimum height

**33.**—(1) Subject to paragraphs (2) and (3), an aircraft must not fly at a height of less than 1,000 feet above the highest obstacle within a distance of 5 nautical miles of the aircraft unless—

- (a) it is necessary for the aircraft to do so in order to take off or land;
- (b) the aircraft flies on a route notified for the purposes of this rule;
- (c) the aircraft has been otherwise authorised by the competent authority in relation to the area over which the aircraft is flying; or
- (d) the aircraft flies at an altitude not exceeding 3,000 feet above mean sea level and remains clear of cloud and with the surface in sight and in a flight visibility of at least 800 metres.

(2) The aircraft must comply with rule 5.

(3) Paragraph (1) does not apply to a helicopter that is air-taxiing or conducting manoeuvres in accordance with rule 6(i).

#### Quadrantal rule and semi-circular rule

**34.**—(1) Subject to paragraphs (2) and (3), an aircraft in level flight above 3,000 feet above mean sea level or above the appropriate transition altitude, whichever is the higher, must be flown at a level appropriate to its magnetic track, in accordance with Table 1 or Table 2, as appropriate.

(2) For the purposes of paragraph (1), the level of flight must be measured by an altimeter set—

- (a) in the case of a flight over the Territory, to a pressure setting of 1013.2 hectopascals; or
- (b) in the case of any other flight, according to the system published by the competent authority in relation to the area over which the aircraft is flying.

(3) An aircraft may be flown at a level other than the level required by paragraph (1) if it flies—

- (a) in conformity with instructions given by an air traffic control unit;
- (b) in accordance with notified en-route holding patterns; or

**Status:** This is the original version (as it was originally made). This item of legislation is currently only available in its original format.

(c) in accordance with holding procedures notified in relation to an aerodrome.

(4) For the purposes of this rule “transition altitude” means the altitude which is notified in relation to flights over notified areas.

**Table 1**

**Flights at Levels below 19,500 Feet**

<i>Magnetic Track</i>	<i>Cruising Level</i>
Less than 90°	Odd thousands of feet
90° but less than 180°	Odd thousands of feet + 500 feet
180° but less than 270°	Even thousands of feet
270° but less than 360°	Even thousands of feet + 500 feet

**Table 2**

**Flights at Levels above 19,500 Feet**

<i>Magnetic Track</i>	<i>Cruising Level</i>	
Less than 180°	21,000 feet	
	23,000 feet	
	25,000 feet	
	27,000 feet	
	29,000 feet	
	31,000 feet	
	33,000 feet	
	35,000 feet	
	37,000 feet	
	39,000 feet	
	41,000 feet or higher levels at intervals of 4,000 feet	
	180° but less than 360°	20,000 feet
		22,000 feet
24,000 feet		
26,000 feet		
28,000 feet		
30,000 feet		
32,000 feet		
34,000 feet		
36,000 feet		
38,000 feet		

*Status: This is the original version (as it was originally made). This item of legislation is currently only available in its original format.*

<i>Magnetic Track</i>	<i>Cruising Level</i>
	40,000 feet
	43,000 feet or higher levels at intervals of 4,000 feet

### **Flight plan and air traffic control clearance**

**35.**—(1) Before an aircraft either takes off from a point within any controlled airspace or otherwise flies within any controlled airspace the pilot-in-command of the aircraft must—

- (a) send or transmit a flight plan complying with paragraph (2) to the appropriate air traffic control unit; and
  - (b) obtain an air traffic control clearance based on that flight plan.
- (2) The flight plan must—
- (a) contain such particulars of the intended flight as may be necessary to enable the air traffic control unit to issue an air traffic control clearance and for search and rescue purposes; and
  - (b) for a flight within Territory reduced vertical separation minimum airspace, also state whether or not the aircraft is equipped with height keeping systems as required by articles 92 or 93 of this Order.

(3) Unless the pilot in command of the aircraft has requested the appropriate air traffic control unit to cancel the flight plan, that pilot must inform that unit immediately the aircraft lands within or leaves the controlled airspace.

### **Compliance with air traffic control clearance and notified procedures**

**36.**—(1) Subject to paragraph (2), the pilot-in-command of the aircraft must fly in conformity with—

- (a) the air traffic control clearance issued for the flight, as amended by any further instructions given by an air traffic control unit; and, unless he is authorised otherwise by the appropriate air traffic control unit;
  - (b) the instrument departure procedures notified in relation to the aerodrome of departure; and
  - (c) the holding and instrument approach procedures notified in relation to the aerodrome of destination.
- (2) The pilot-in-command of the aircraft is not required to comply with paragraph (1) if—
- (a) the flight can be conducted in uninterrupted Visual Meteorological Conditions while in controlled airspace; and
  - (b) the pilot has informed the appropriate air traffic control unit of the intention to continue the flight in compliance with Visual Flight Rules and has requested that unit to cancel the flight plan.

(3) If any deviation is made from the provisions of paragraph (2) for the purpose of avoiding immediate danger the pilot-in-command of the aircraft must inform the appropriate air traffic control unit of the deviation as soon as possible.

### **Position reports**

**37.** The pilot-in-command of an aircraft in IFR flight who flies in or is intending to enter controlled airspace must report to the appropriate air traffic control unit the time, position and level of the aircraft at such reporting points or at such intervals of time as may be notified for this purpose or as may be directed by the air traffic control unit.

## SECTION 7

### AERODROME TRAFFIC RULES

#### Application of aerodrome traffic rules

**38.**—(1) The rules in this Section which expressly apply to flying machines must also be observed, so far as is practicable, by all other aircraft.

#### Visual signals

**39.**—(1) Subject to paragraph (2), the pilot-in-command of a flying machine on, or in the pattern of traffic flying at, an aerodrome must—

- (a) observe such visual signals as may be displayed at or directed to that pilot from the aerodrome by the authority of the person in charge of the aerodrome; and
- (b) obey any instructions which may be given by means of such signals.

(2) The pilot-in-command of a flying machine is not required to obey such signals if it is inadvisable to do so in the interests of safety.

#### Movement of aircraft on aerodromes

**40.** An aircraft must not taxi or air-taxi on the apron or the manoeuvring area of an aerodrome without the permission of either—

- (a) the person in charge of the aerodrome; or
- (b) the air traffic control unit or aerodrome flight information service unit notified as being on watch at the aerodrome.

#### Access to and movement of persons and vehicles on aerodromes

**41.**—(1) Unless there is a public right of way over it, a person or vehicle must—

- (a) not go onto any part of an aerodrome without the permission of the person in charge of that part of the aerodrome; and
- (b) comply with any conditions subject to which that permission may be granted.

(2) A person or vehicle must—

- (a) not go onto or move on the manoeuvring area of an aerodrome which has an air traffic control unit or an aerodrome flight information service unit without the permission of that unit; and
- (b) comply with any conditions subject to which that permission may be granted.

(3) Any permission granted for the purposes of this rule may be granted whether in respect of persons or vehicles generally, or in respect of any particular person or vehicle or any class of person or vehicle.

#### Right of way on the ground

**42.**—(1) This rule applies to flying machines and vehicles on any part of a land aerodrome provided for the use of aircraft.

(2) Notwithstanding any air traffic control clearance it remains the duty of the pilot-in-command of a flying machine to take all possible measures to ensure that the flying machine does not collide with any other aircraft or vehicle.

(3) Flying machines and vehicles must give way to aircraft which are taking off or landing.

*Status: This is the original version (as it was originally made). This item of legislation is currently only available in its original format.*

(4) Vehicles and flying machines which are not taking off or landing must give way to vehicles towing aircraft.

(5) Vehicles which are not towing aircraft must give way to aircraft.

**Action to be taken in case of danger of collision on the ground**

**43.**—(1) Subject to rules 42 and 14(3), this rule applies if there is any danger of collision between two flying machines on the ground.

(2) If the two flying machines are approaching head-on, or approximately so, each must alter its course to the right.

(3) If the two flying machines are on converging courses, the flying machine which has the other flying machine on its right must give way to that other flying machine and must avoid crossing ahead of it unless passing well clear of it.

(4) A flying machine which is being overtaken by another flying machine has the right-of-way over the flying machine overtaking it.

(5) A flying machine which is overtaking another flying machine must keep out of the way of the other flying machine by altering its course to the left until that other flying machine has been passed and is clear, notwithstanding any change in the relative positions of the two flying machines.

(6) A vehicle must—

(a) overtake another vehicle on the right hand side of that vehicle ; and

(b) keep to the left when passing another vehicle which is approaching head-on or approximately so.

**Launching, picking up and dropping of tow ropes, etc.**

**44.**—(1) Tow ropes, banners or similar articles towed by aircraft must not be launched at an aerodrome except in accordance with arrangements made with—

(a) the air traffic control unit at the aerodrome; or

(b) if there is no such unit, the person in charge of the aerodrome.

(2) Tow ropes, banners or similar articles towed by aircraft must not be picked up by or dropped from aircraft at an aerodrome except—

(a) in accordance with arrangements made with the air traffic control unit at the aerodrome or, if there is no such unit, with the person in charge of the aerodrome; or

(b) in the area designated by the marking described in rule 59(9), but only when the aircraft is flying in the direction appropriate for landing.

**Flights within aerodrome traffic zones**

**45.**—(1) Paragraphs (2) and (3) apply only in relation to those aerodromes described in Column 1 of Table 3 as are notified for the purposes of this rule and at such times as are specified in Column 2 of the Table.

**Table 3**

<i>Column 1</i>	<i>Column 2</i>
(a) A military aerodrome	At such times as are notified
(b) An aerodrome having an air traffic control unit or flight information service unit	During the notified hours of watch of the air traffic control unit or the flight information service unit

<i>Column 1</i>	<i>Column 2</i>
(c) A certificated aerodrome having a means of two-way radio communication with aircraft	During the notified hours of watch of the air/ground station

(2) An aircraft must not fly, take off or land within the aerodrome traffic zone of an aerodrome unless the pilot-in-command of the aircraft has complied with paragraphs (3), (4) or (5), as appropriate.

(3) If the aerodrome has an air traffic control unit, the pilot-in-command must obtain the permission of the air traffic control unit to enable the flight to be conducted safely within the zone.

(4) If the aerodrome has a flight information service unit, the pilot-in-command must obtain information from the flight information service unit to enable the flight to be conducted safely within the zone.

(5) If there is no flight information service unit at the aerodrome, the pilot-in-command must obtain information from the air/ground communication service to enable the flight to be conducted safely within the zone.

(6) The pilot-in-command of an aircraft flying within the aerodrome traffic zone of an aerodrome must—

- (a) cause a continuous watch to be maintained on the appropriate radio frequency notified for communications at the aerodrome; or
- (b) if this is not possible, cause a watch to be kept for such instructions as may be issued by visual means; and
- (c) if the aircraft is fitted with means of communication by radio with the ground, communicate his position and height to the air traffic control unit, the flight information service unit or the air/ground communication service at the aerodrome (as the case may be) on entering the zone and immediately prior to leaving it.

## SECTION 8

### LIGHTS AND OTHER SIGNALS TO BE SHOWN OR MADE BY AIRCRAFT

#### General

**46.**—(1) For the purposes of this Section of the Rules the horizontal plane of a light shown by an aircraft means the plane which would be the horizontal plane passing through the source of that light if the aircraft were in level flight.

(2) If it is necessary to fit more than one lamp in order to show a light required by this Section because of the physical construction of an aircraft, the lamps must be so fitted and constructed that, so far as is reasonably practicable, not more than one such lamp is visible from any one point outside the aircraft.

(3) If a light is required by this Section to show through specified angles in the horizontal plane, the lamps giving such light must be so constructed and fitted that the light is visible—

- (a) from any point in any vertical plane within those angles throughout angles of 90° above and below the horizontal plane; but
- (b) so far as is reasonably practicable, through no greater angle, either in the horizontal plane or the vertical plane.

(4) If a light is required by this Section to show in all directions, the lamps giving such light must be so constructed and fitted that, so far as is reasonably practicable, the light is visible from any point in the horizontal plane and on any vertical plane passing through the source of that light.

*Status: This is the original version (as it was originally made). This item of legislation is currently only available in its original format.*

(5) Notwithstanding the provisions of this Section the pilot-in-command of an aircraft may switch off or reduce the intensity of any flashing light fitted to the aircraft if such a light does or is likely to—

- (a) adversely affect the performance of the duties of any member of the flight crew; or
- (b) subject an outside observer to unreasonable dazzle.

### **Display of lights by aircraft**

47.—(1) During the night an aircraft must—

- (a) display such of the lights specified in this Section as it is required by this Section; and
- (b) subject to rule 49(6), not display any other lights which might obscure or otherwise impair the visibility of, or be mistaken for, such lights.

(2) Subject to rule 48(4) an aircraft fitted with an anti-collision light must display that light in flight during the day.

(3) A flying machine on a Territory aerodrome must—

- (a) during the night display either the lights which it would be required to display when flying or the lights specified in rule 49(5)(c), unless it is stationary on the apron or on that part of the aerodrome provided for the maintenance of aircraft; and
- (b) during the day and night and subject to paragraph (4), display a red anti-collision light, if it is fitted with one, when it is stationary on the apron with engines running.

(4) A helicopter to which article 96 applies may, when stationary on an offshore installation, switch off the anti-collision light required to be shown by paragraph (3)(b) as long as that is done in accordance with a procedure contained in the operations manual of the helicopter as a signal to ground personnel that it is safe to approach the helicopter for the purpose of embarkation or disembarkation of passengers or the loading or unloading of cargo.

### **Failure of navigation and anti-collision lights**

48.—(1) Paragraphs (2), (3) and (4) apply to aircraft in the Territory.

(2) An aircraft must not depart from an aerodrome if there is a failure of any light which these Rules require to be displayed at night and the light cannot be immediately repaired or replaced.

(3) Subject to paragraph (4), if the aircraft is in flight and any such light as is referred to in paragraph (2) fails and cannot be immediately repaired or replaced, the aircraft must land as soon as it can safely do so, unless authorised by the appropriate air traffic control unit to continue its flight.

(4) An aircraft may continue to fly during the day in the event of a failure of an anti-collision light on the flight as long as the light is repaired at the earliest practicable opportunity.

### **Flying machines at night**

49.—(1) Subject to paragraph (6), a flying machine flying at night must display lights in accordance with paragraphs (2), (3) or (4), as appropriate.

(2) In the case of—

- (a) a flying machine registered in the Territory which has a maximum total weight authorised of more than 5,700 kg; or
- (b) any other flying machine registered in the Territory which conforms to a type first issued with a type certificate on or after 1st April 1988,

the flying machine must display the system of lights specified in paragraph 5(b).

(3) A flying machine registered in the Territory which—



- (a) conforms to a type first issued with a type certificate before 1st April 1988; and
  - (b) has a maximum total weight authorised of 5,700 kg or less,
- must display the system of lights specified in—
- (i) paragraph (5)(a); or
  - (ii) paragraph (5)(b); or
  - (iii) paragraph (5)(d), but excluding sub-paragraph (ii) of that paragraph.
- (4) In the case of any other flying machine, one of the systems of lights specified in paragraph (5) must be displayed.
- (5) The systems of lights referred to in paragraphs (2), (3) and (4) are as follows—
- (a) A steady green light of at least five candela showing to the starboard side through an angle of 110° from dead ahead in the horizontal plane; a steady red light of at least five candela showing to the port side through an angle of 110° from dead ahead in the horizontal plane; and a steady white light of at least three candela showing through angles of 70° from dead astern to each side in the horizontal plane;
  - (b) the lights specified in sub-paragraph (a) and an anti-collision light;
  - (c) the lights specified in sub-paragraph (a), but all being flashing lights (rather than steady lights) flashing together;
  - (d) the lights specified in sub-paragraph (a), but all being flashing lights (rather than steady lights) flashing together in alternation with one or both of the following—
    - (i) a flashing white light of at least 20 candela showing in all directions;
    - (ii) a flashing red light of at least 20 candela showing through angles of 70° from dead astern to each side in the horizontal plane.
- (6) If the lamp showing either the red or the green light specified in paragraph (5)(a) is fitted more than 2 metres from the wing tip, another lamp may be fitted at the wing tip to indicate its position showing a steady light of the same colour through the same angle.

### **Gliders at night**

**50.** A glider flying at night must display either a steady red light of at least five candela, showing in all directions, or lights in accordance with rule 49(5) and (6).

### **Free balloons at night**

**51.** A free balloon flying at night must display a steady red light of at least five candela showing in all directions, suspended not less than 5 metres and not more than 10 metres below the basket, or if there is no basket, below the lowest part of the balloon.

### **Captive balloons and kites at night**

**52.—(1)** A captive balloon or kite flying at night at a height exceeding 60 metres above the surface must display lights in accordance with paragraphs (2), (3) and (4).

(2) A group of two steady lights must be displayed consisting of a white light placed 4 metres above a red light, both being of at least five candela and showing in all directions, the white light being placed not less than 5 metres nor more than 10 metres below the basket or, if there is no basket, below the lowest part of the balloon or kite.

(3) On the mooring cable of the balloon or kite, at intervals of not more than 300 metres measured from the group of lights specified in paragraph (2), there must be displayed—

*Status: This is the original version (as it was originally made). This item of legislation is currently only available in its original format.*

- (a) groups of two lights of the colour and power and in the relative positions specified in paragraph (2); and
  - (b) if the lowest group of lights is obscured by cloud, an additional group of such lights below the cloud base.
- (4) On the surface of the ground there must be displayed a group of three flashing lights arranged—
- (a) in a horizontal plane at the apexes of a triangle, approximately equilateral, each side of which measures at least 25 metres;
  - (b) so that one side of the triangle must be approximately at right angles to the horizontal projection of the cable and must be delimited by two red lights; and
  - (c) so that the third light must be a green light, placed so that the triangle encloses the object on the surface to which the balloon or kite is moored.

#### **Captive balloons and kites by day**

**53.**—(1) A captive balloon flying by day at a height exceeding 60 metres above the surface must have attached to its mooring cable tubular streamers which are—

- (a) not less than 40 centimetres in diameter and 2 metres in length; and
- (b) marked with alternate bands of red and white 50 centimetres wide at intervals of not more than 200 metres measured from the basket or, if there is no basket, from the lowest part of the balloon.

(2) A kite flying by day at a height exceeding 60 metres above the surface must have attached to its mooring cable either—

- (a) tubular streamers as specified in paragraph (1); or
- (b) at intervals of not more than 100 metres measured from the lowest part of the kite, streamers not less than 80 centimetres long and 30 centimetres wide at their widest point, marked with alternate bands of red and white 10 centimetres wide.

#### **Airships at night**

**54.**—(1) Except as provided in paragraph (2), an airship flying at night must display the following lights—

- (a) a steady white light of at least five candela showing through angles of  $110^\circ$  from dead ahead to each side in the horizontal plane;
- (b) a steady green light of at least five candela showing to the starboard side through an angle of  $110^\circ$  from dead ahead in the horizontal plane;
- (c) a steady red light of at least five candela showing to the port side through an angle of  $110^\circ$  from dead ahead in the horizontal plane;
- (d) a steady white light of at least five candela showing through angles of  $70^\circ$  from dead astern to each side in the horizontal plane; and
- (e) an anti-collision light.

(2) Subject to paragraph (5), an airship flying at night in any of the circumstances referred to in paragraph (3) must display the lights specified in paragraph (4).

(3) The circumstances are as follows—

- (a) if the airship is not under command; or
- (b) has voluntarily stopped its engines, or

- (c) is being towed.
- (4) The lights specified are the following lights—
  - (a) the white lights specified in paragraph (1)(a) and (d);
  - (b) two steady, red lights, each of at least five candela, showing in all directions, suspended below the control car so that one is at least 4 metres above the other and at least 8 metres below the control car; and
  - (c) if the airship is making way but not otherwise, the green and red lights specified in paragraph (1)(b) and (c).
- (5) An airship picking up its moorings at night must display the lights specified in paragraph (1).
- (6) An airship moored to a mooring mast within the Territory at night must display, at or near the rear of the airship, a steady, white light of at least five candela showing in all directions.
- (7) An airship moored otherwise than to a mooring mast within the Territory at night must display—
  - (a) a white light of at least five candela showing through angles of 110° from dead ahead to each side in the horizontal plane; and
  - (b) a white light of at least five candela showing through angles of 70° from dead astern to each side in the horizontal plane.

#### **Airships by day**

**55.**—(1) An airship flying during the day in any of the circumstances referred to in paragraph (2) must display two black balls suspended below the control car so that one is at least 4 metres above the other and at least 8 metres below the control car.

- (2) The circumstances are as follows—
  - (a) if the airship is not under command;
  - (b) if it has voluntarily stopped its engines; or
  - (c) if it is being towed.
- (3) For the purposes of this rule and rule 54—
  - (a) an airship is deemed not to be under command when it is unable to execute a manoeuvre which it may be required to execute by these Rules; and
  - (b) an airship is deemed to be making way when it is not moored and is in motion.

#### **Signals in the Signals Area**

**56.**—(1) Whenever any signal specified in this rule is displayed it shall be placed in a signals area, which shall be a square visible from all directions bordered by a white strip 30 centimetres wide and with the internal sides measuring 12 metres.

- (2) A white landing T, as illustrated in this paragraph,

*Status: This is the original version (as it was originally made). This item of legislation is currently only available in its original format.*

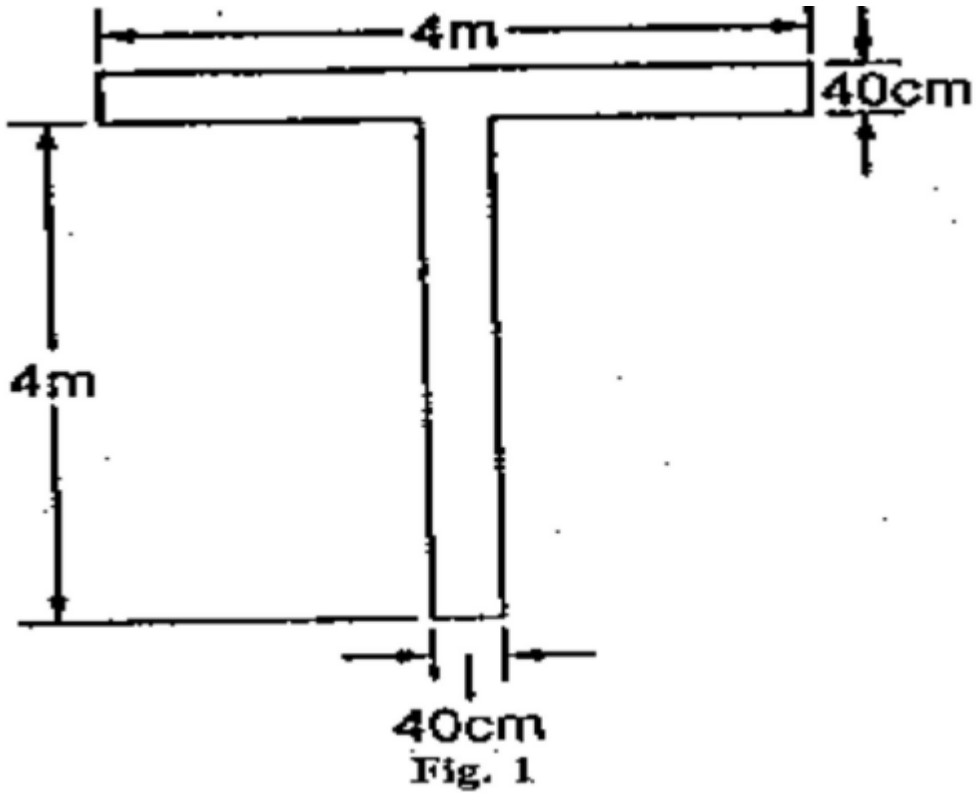

signifies that aeroplanes and gliders taking off or landing shall do so in a direction parallel with the shaft of the T and towards the cross arm, unless otherwise authorised by the appropriate air traffic control unit.

(3) A white disc 60 centimetres in diameter displayed alongside the cross arm of the T and in line with the shaft of the T, as illustrated in this paragraph,

*Status:* This is the original version (as it was originally made). This item of legislation is currently only available in its original format.

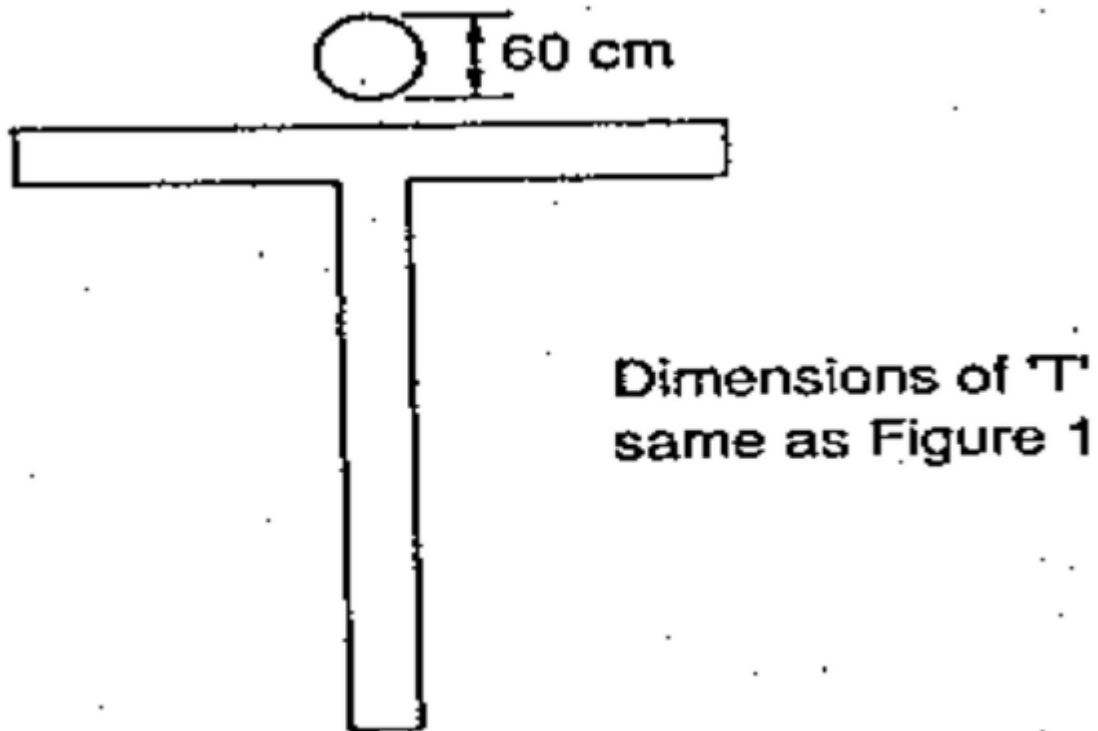

**Fig. 2**

signifies that the direction of landing and take off do not necessarily coincide.

(4) A white dumb-bell, as illustrated in this paragraph,

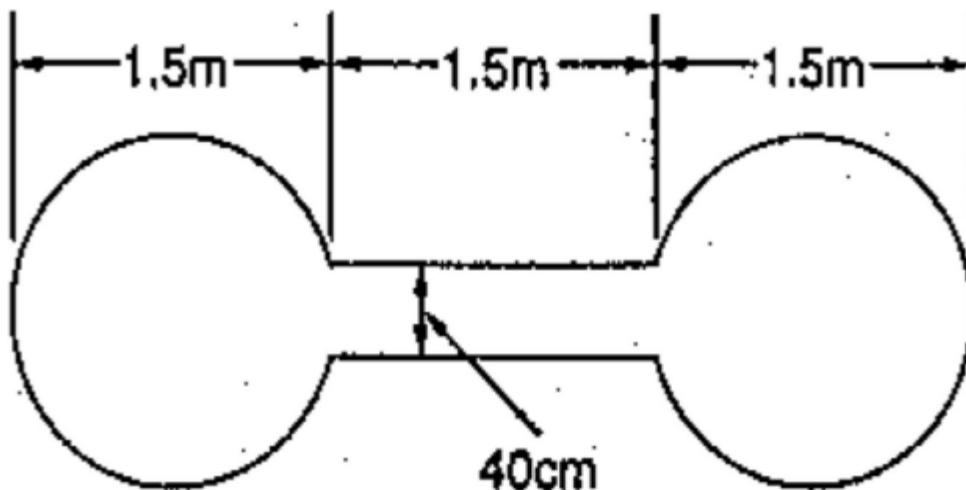

**Fig. 3**

signifies that movements of aeroplanes and gliders on the ground shall be confined to paved, metalled or similar hard surfaces.

A white dumb-bell, as described in paragraph (4), but with a black strip 60 centimetres wide across each disc at right angles to the shaft of the dumb-bell, as illustrated in this paragraph,

Status: This is the original version (as it was originally made). This item of legislation is currently only available in its original format.

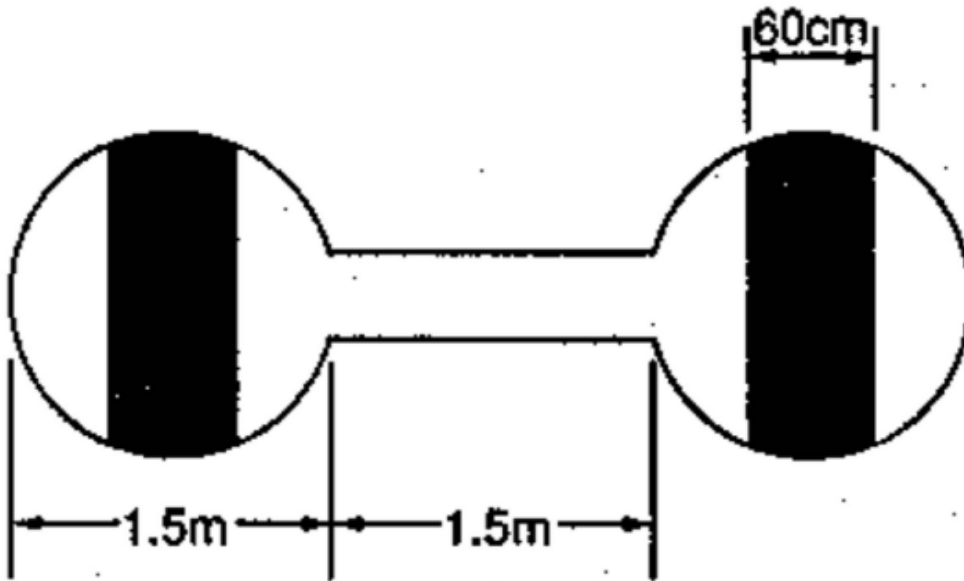

Fig. 4

signifies that aeroplanes and gliders taking off or landing shall do so on a runway but that movement on the ground is not confined to paved, metalled or similar hard surfaces.

(5) A red and yellow striped arrow, as illustrated in this paragraph,

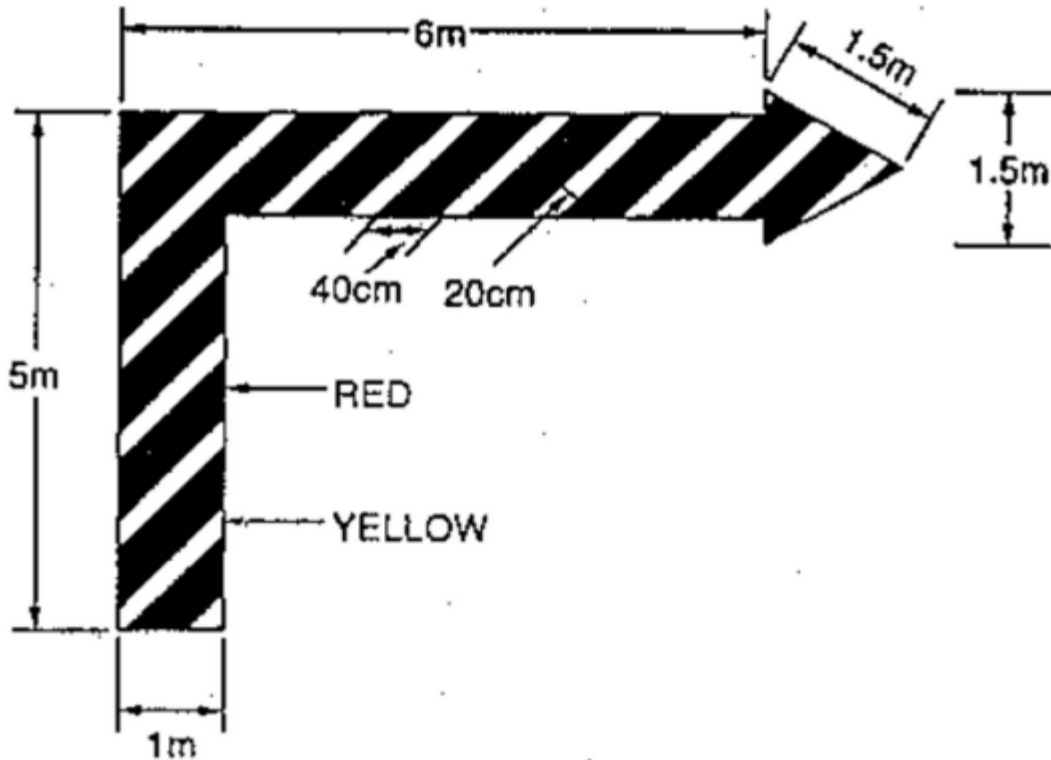
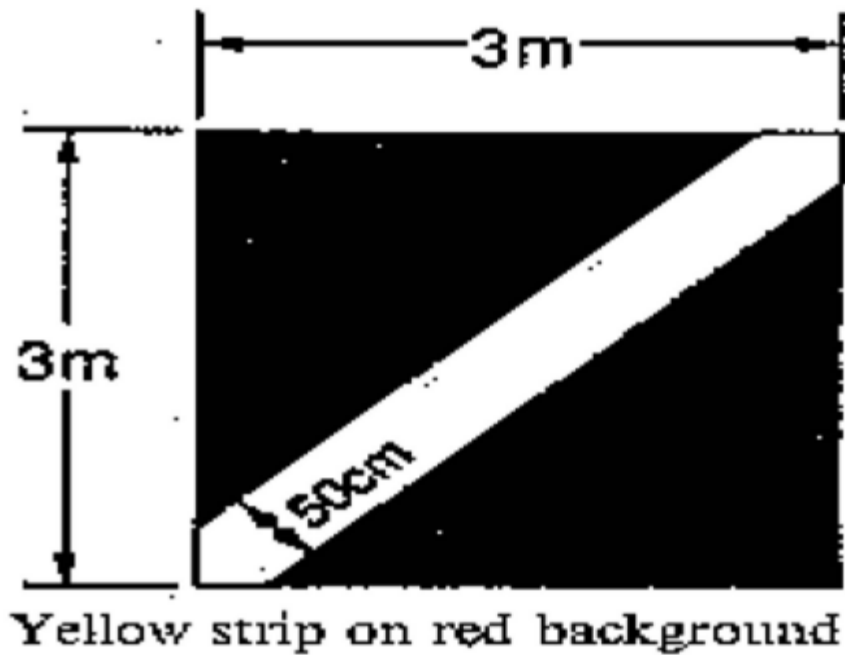

Fig. 5

**Status:** This is the original version (as it was originally made). This item of legislation is currently only available in its original format.

the shaft of which is one metre wide and which is placed along the whole or a total of 11 metres of two adjacent sides of the signals area, and pointing in a clockwise direction, signifies that a right-hand circuit is in force.

(6) A red panel 3 metres square with a yellow strip along one diagonal 50 centimetres wide, as illustrated in this paragraph,



**Fig. 6**

signifies that the state of the manoeuvring area is poor and pilots must exercise special care when landing.

(7) A red panel 3 metres square with a yellow strip 50 centimetres wide along each diagonal, as illustrated in this paragraph,

*Status:* This is the original version (as it was originally made). This item of legislation is currently only available in its original format.

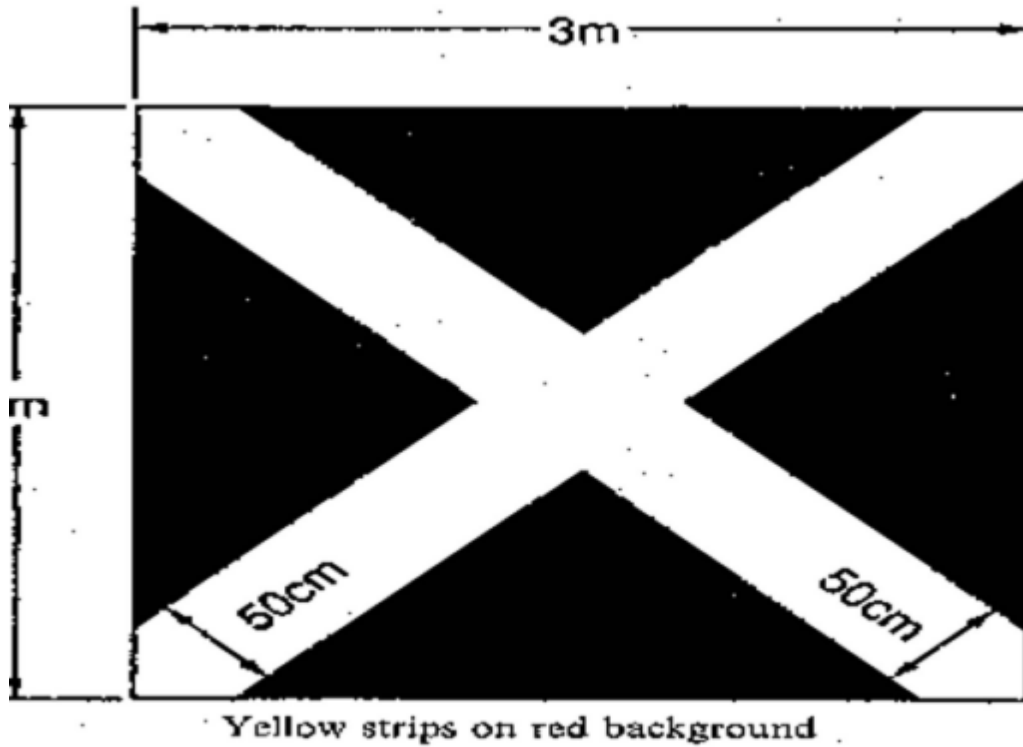

Fig. 7

signifies that the aerodrome is unsafe for the movement of aircraft and that landing on the aerodrome is prohibited.

(8) A white letter H, as illustrated in this paragraph,



**Status:** This is the original version (as it was originally made). This item of legislation is currently only available in its original format.

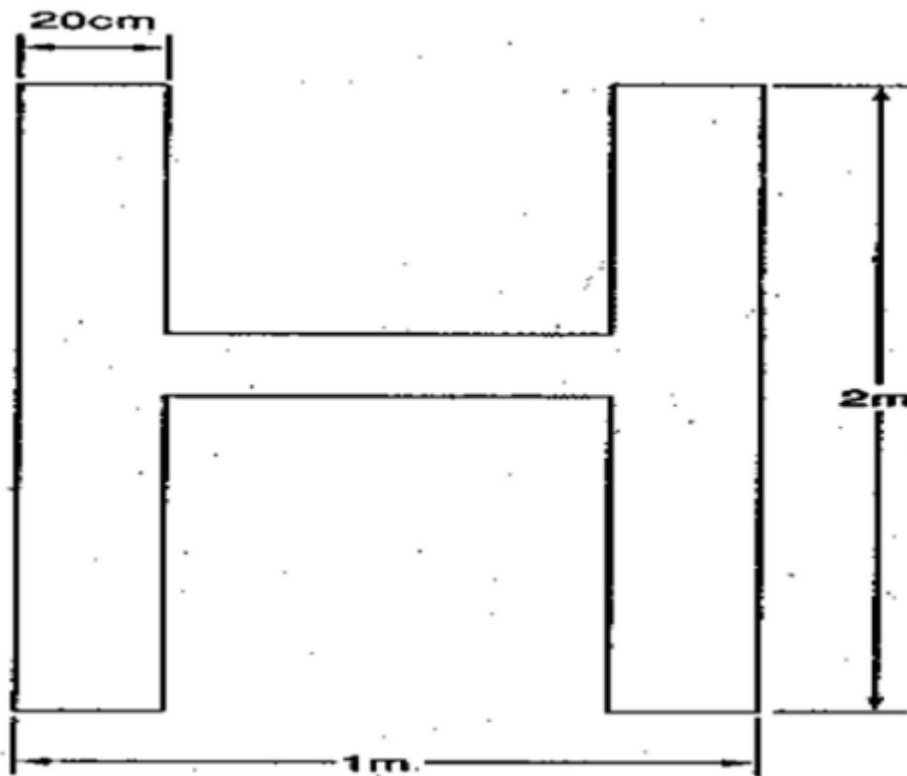

Fig. 8

signifies that helicopters shall take off and land only within the area designated by the marking specified in rule 59(7).

(9) A red letter L displayed on the dumb-bell specified in paragraphs (4) and (5), as illustrated in this paragraph,

*Status: This is the original version (as it was originally made). This item of legislation is currently only available in its original format.*

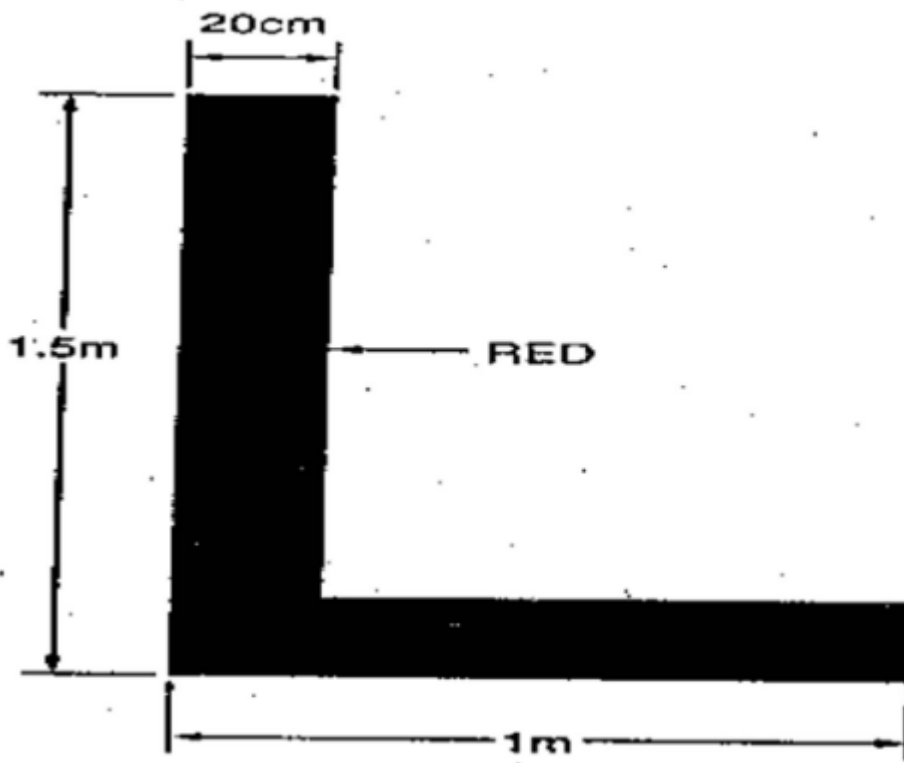
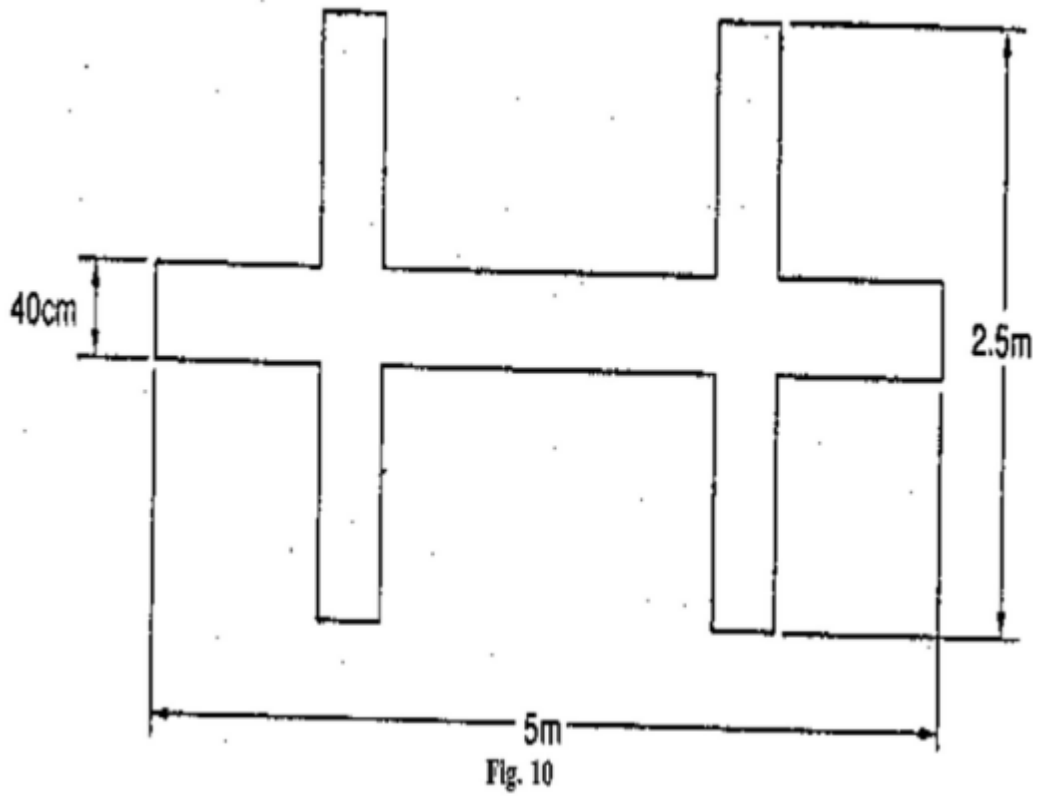

Fig. 9

signifies that light aircraft are permitted to take off and land either on a runway or on the area designated by the marking specified in rule 59(8).

(10) A white double cross, as illustrated in this paragraph,

**Status:** This is the original version (as it was originally made). This item of legislation is currently only available in its original format.



signifies that glider flying is in progress.

#### Markings for paved runways and taxiways

57.—(1) Two or more white crosses, as illustrated in this paragraph,

**Status:** This is the original version (as it was originally made). This item of legislation is currently only available in its original format.

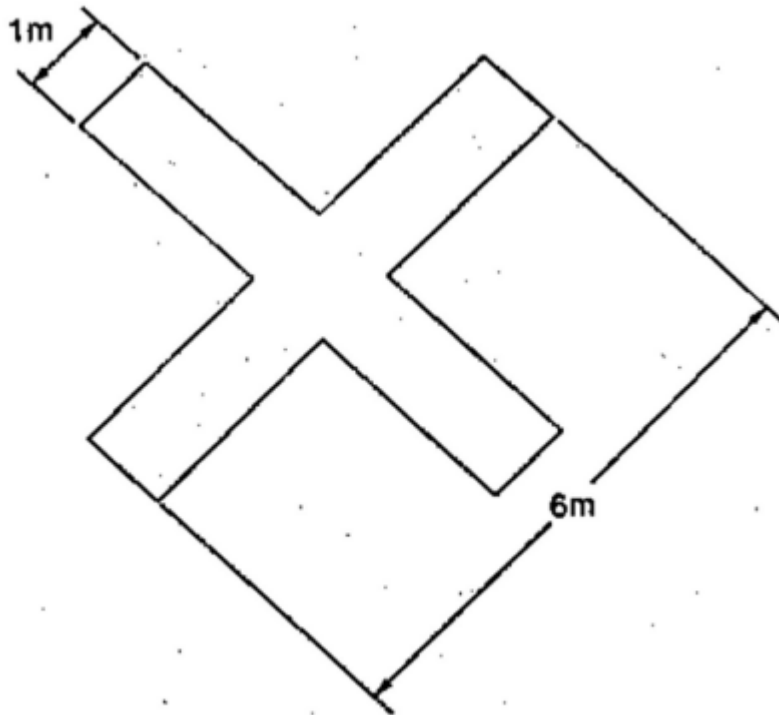
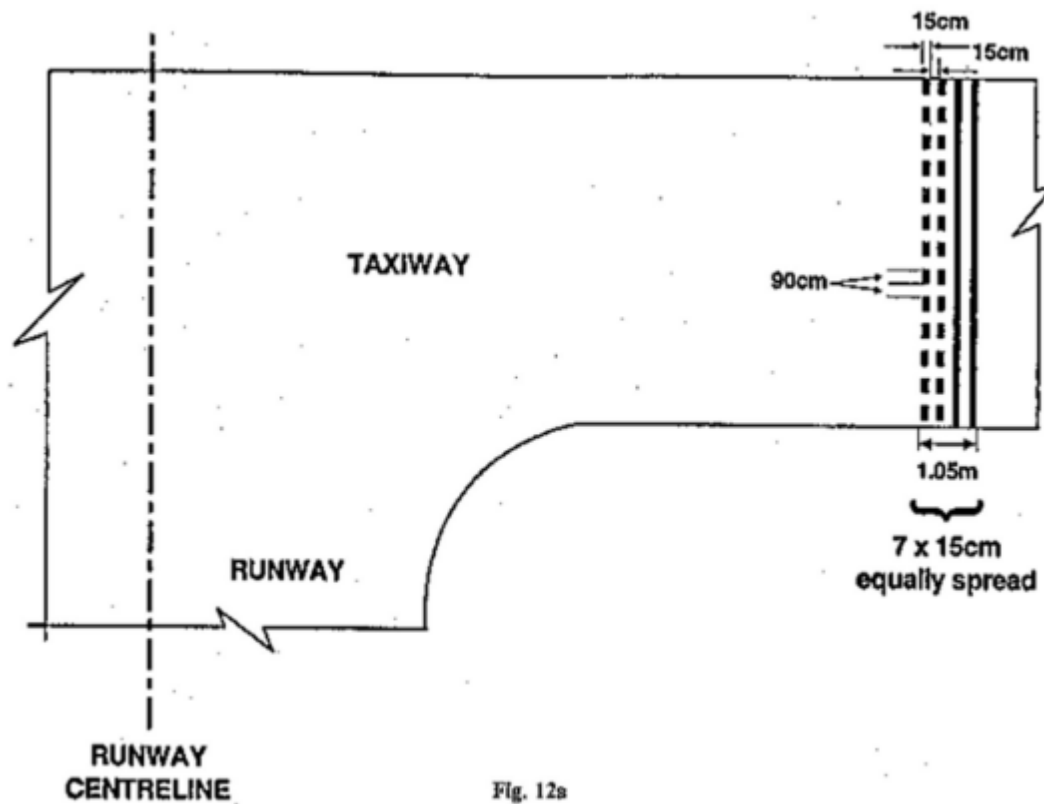

**Fig. 11**

displayed on a runway or taxiway, with each arm of each cross at an angle of 45° to the centre line of the runway, at intervals of not more than 300 metres signify that the section of the runway or taxiway marked by them is unfit for the movement of aircraft.

(2) Subject to paragraph (3), two yellow broken lines and two continuous lines, as illustrated

**Status:** This is the original version (as it was originally made). This item of legislation is currently only available in its original format.



in this paragraph, signify the designated visual holding position associated with a runway beyond which no part of a flying machine or vehicle shall project in the direction of the runway without permission from the air traffic control unit at the aerodrome during the notified hours of watch of that unit.

(3) Outside the notified hours of watch of that unit or where there is no air traffic control unit at the aerodrome the markings referred to in paragraph (2) signify the position closest to the runway beyond which no part of a flying machine or vehicle shall project in the direction of the runway when the flying machine or vehicle is required by virtue of rule 42(3) to give way to aircraft which are taking off from or landing on that runway.

Subject to paragraph (5), a yellow marking, as illustrated in this paragraph,

*Status: This is the original version (as it was originally made). This item of legislation is currently only available in its original format.*

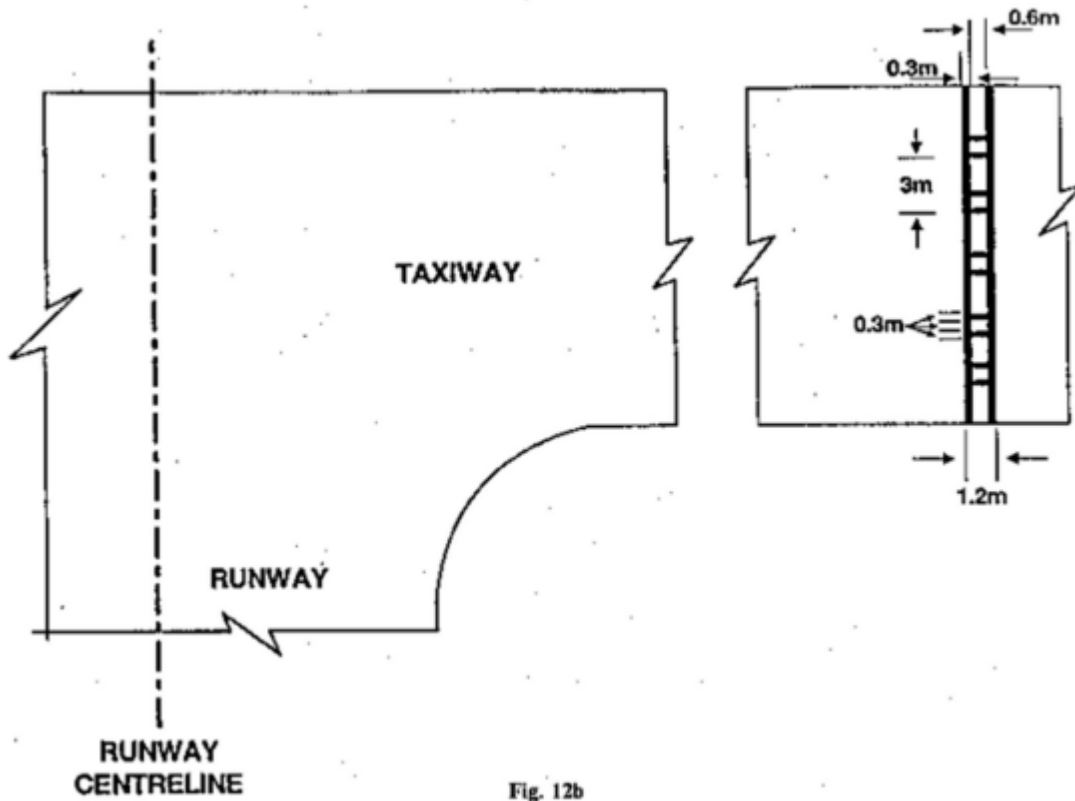

Fig. 12b

signifies a holding position other than that closest to the runway beyond which no part of a flying machine or vehicle shall project in the direction of the runway without permission from the air traffic control unit at the aerodrome during the notified hours of watch of that unit.

(4) Outside the notified hours of watch of that unit or where there is no air traffic control unit at the aerodrome the marking referred to in paragraph (4) may be disregarded.

(5) Orange and white markers, as illustrated in this paragraph,

**Status:** This is the original version (as it was originally made). This item of legislation is currently only available in its original format.

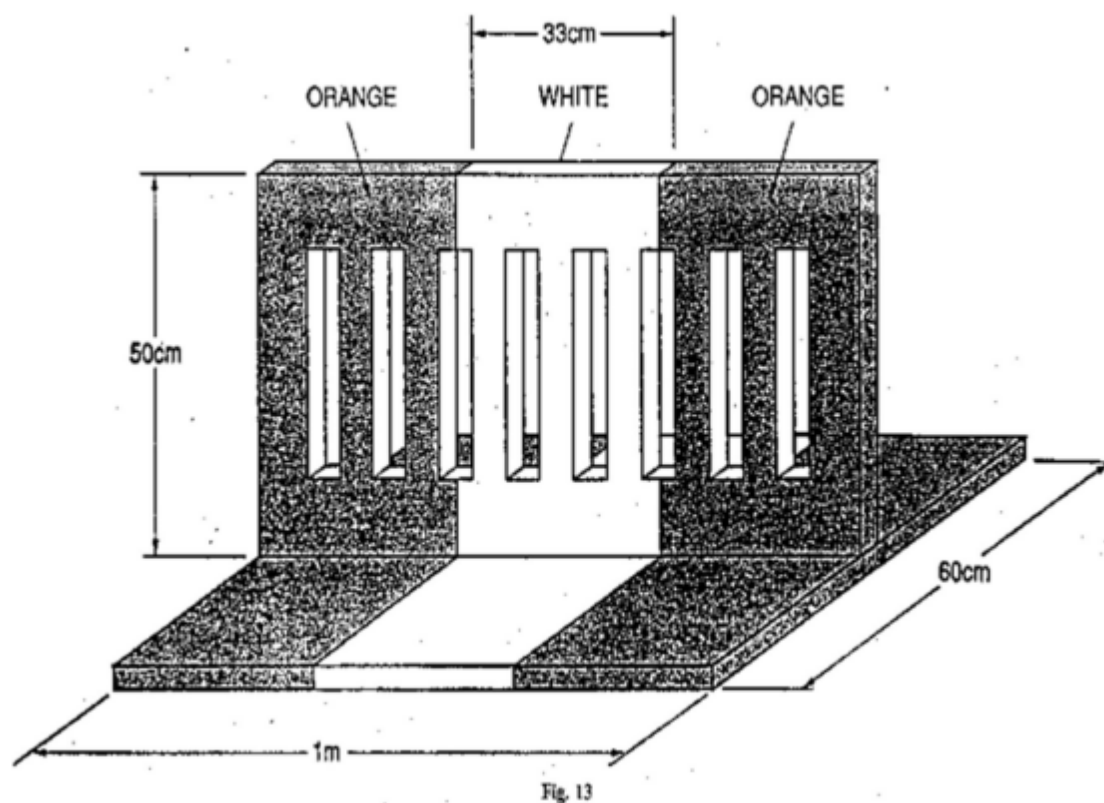

spaced no more than 15 metres apart, signify the boundary of that part of a paved runway, taxiway or apron which is unfit for the movement of aircraft.

#### Markings on unpaved manoeuvring areas

58.—(1) Markers with orange and white stripes of an equal width of 50 centimetres, with an orange stripe at each end, alternating with flags 60 centimetres square showing equal orange and white triangular areas, spaced not more than 90 metres apart as illustrated in this paragraph,

*Status: This is the original version (as it was originally made). This item of legislation is currently only available in its original format.*

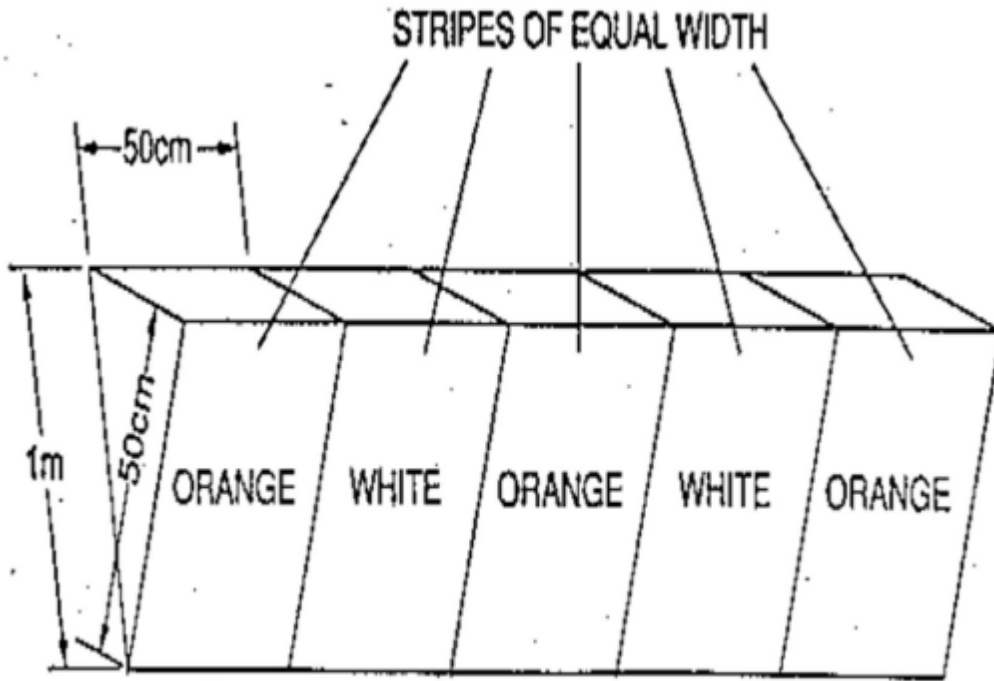

Fig. 14

indicate the boundary of an area unfit for the movement of aircraft.

(2) One or more white crosses, as specified in rule 58(1), also indicate such an area as is referred to in paragraph (1).

(3) Striped markers, as specified in paragraph (1), spaced not more than 45 metres apart, indicate the boundary of an aerodrome.

(4) On structures markers with orange and white vertical stripes, of an equal width of 50 centimetres, with an orange stripe at each end, spaced not more than 45 metres apart, as illustrated in this paragraph.



**Status:** This is the original version (as it was originally made). This item of legislation is currently only available in its original format.

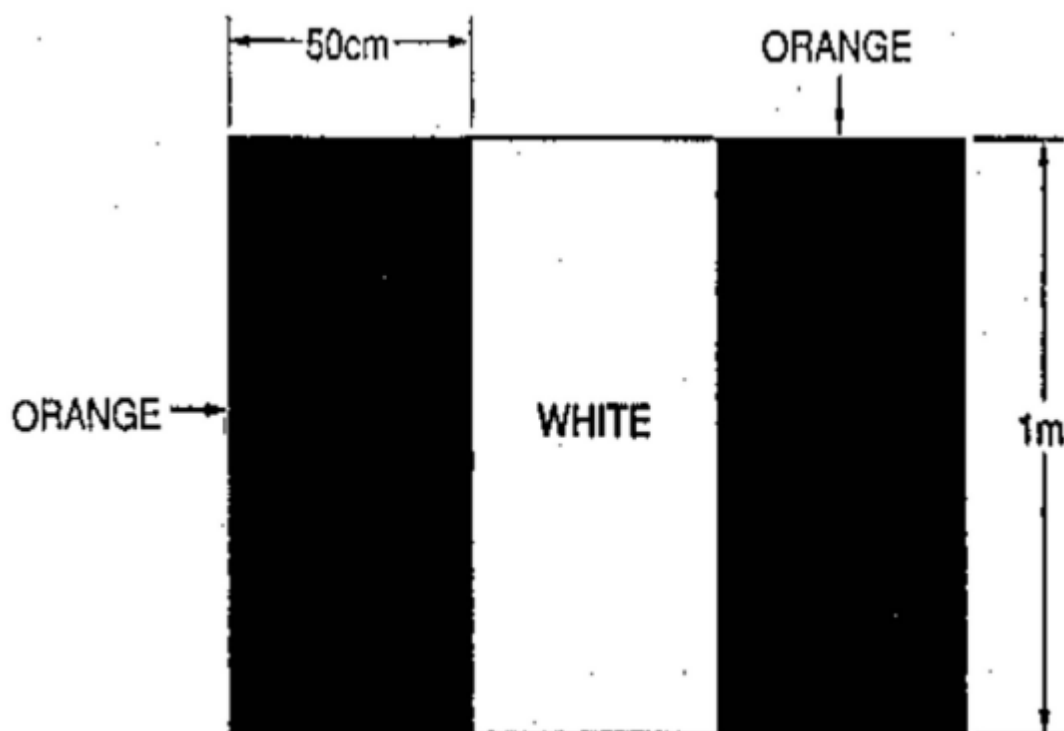

Fig. 15

indicate the boundary of an aerodrome.

(5) The pattern of the marker referred to in paragraph (4) shall be visible from inside and outside the aerodrome and the marker shall be affixed not more than 15 centimetres from the top of the structure.

(6) White, flat, rectangular markers 3 metres long and 1 metre wide, at intervals not exceeding 90 metres, flush with the surface of an unpaved runway or stopway, indicate the boundary of the unpaved runway or stopway.

(7) A white letter H, as illustrated in this paragraph,

**Status:** This is the original version (as it was originally made). This item of legislation is currently only available in its original format.

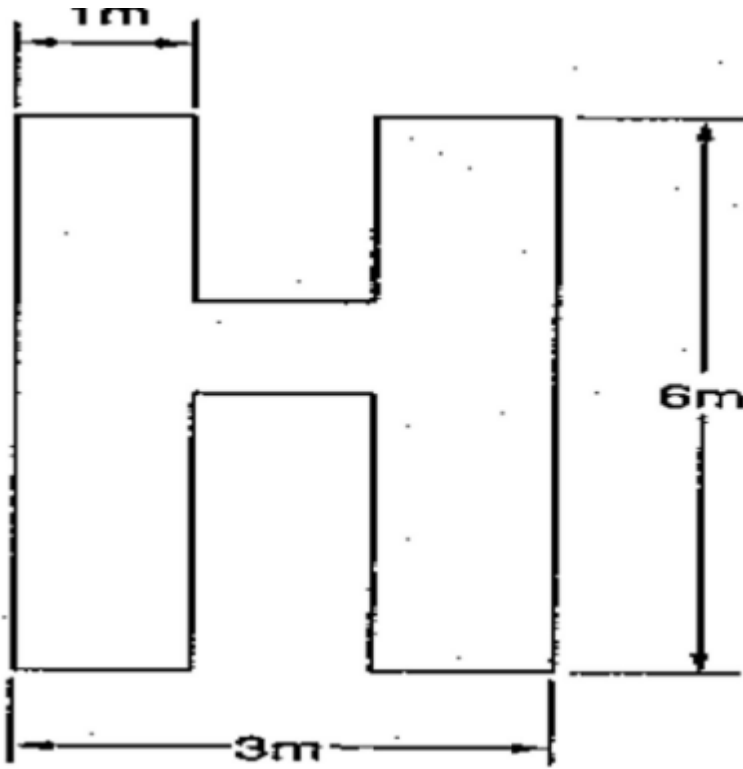
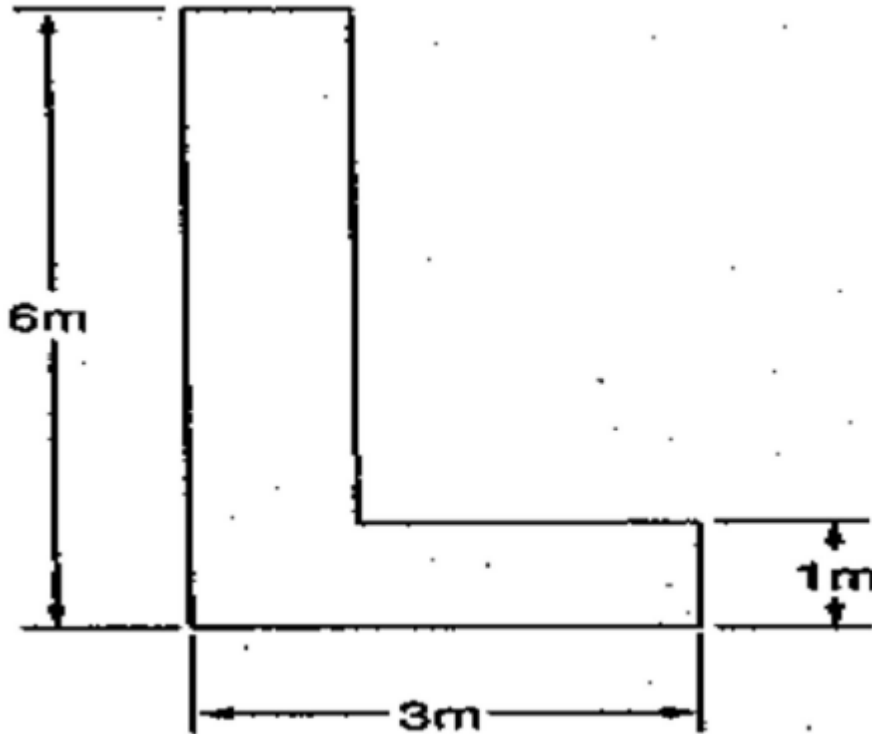

**Fig. 16**

indicates an area which shall be used only for the taking off and landing of helicopters.

(8) A white letter L, as illustrated in this paragraph,

**Status:** This is the original version (as it was originally made). This item of legislation is currently only available in its original format.



**Fig. 17**

indicates a part of the manoeuvring area which shall be used only for the taking off and landing of light aircraft.

(9) A yellow cross with two arms each 6 metres long by 1 metre wide at right angles, indicates that tow ropes, banners and similar articles towed by aircraft shall only be picked up and dropped in the area in which the cross is placed.

(10) A white double cross, as illustrated in this paragraph,

*Status: This is the original version (as it was originally made). This item of legislation is currently only available in its original format.*

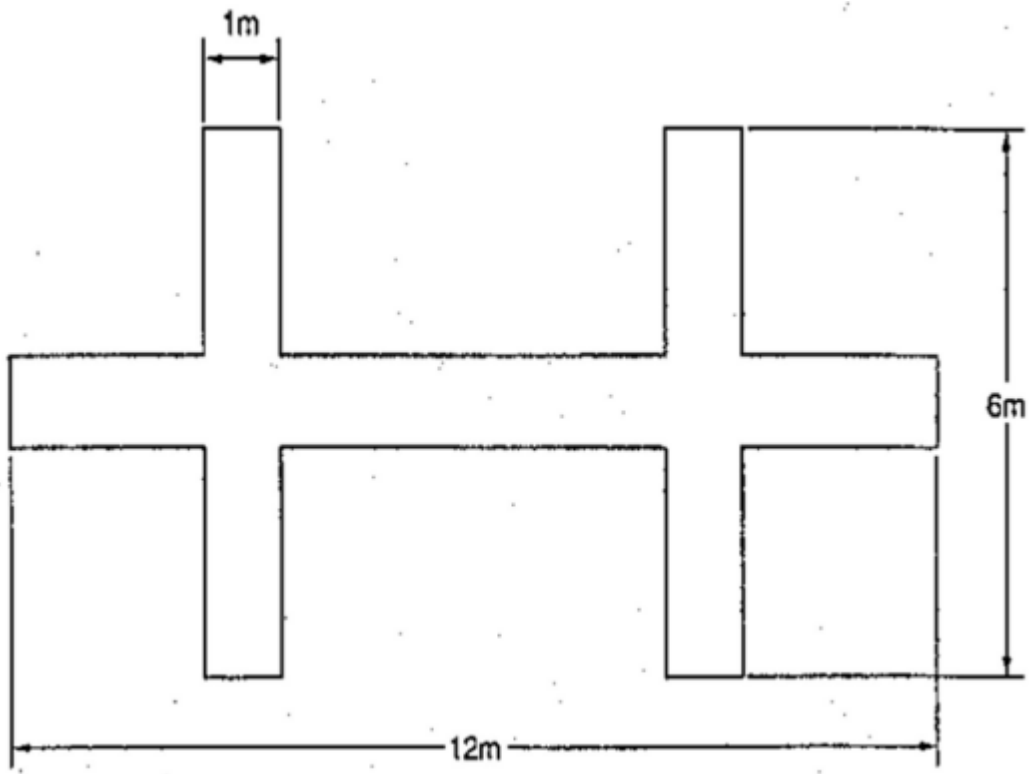

Fig. 18

indicates an area which shall be used only for the taking off and landing of gliders.

(11) Subject to paragraph (12) a white landing T, as specified in rule 57(2), placed at the left-hand side of the runway (when viewed from the direction of landing) indicates the runway to be used for take-off and landing.

(12) The white landing T referred to in paragraph (11), when placed at an aerodrome with no runway, indicates the direction for take-off and landing.

### Signals visible from the ground

**59.**—(1) A black ball, 60 centimetres in diameter, suspended from a mast signifies that the directions of take-off and landing are not necessarily the same.

(2) A chequered flag or board, 1.2 metres by 90 centimetres, containing 12 equal squares, 4 horizontally and 3 vertically, coloured red and yellow alternately, signifies that aircraft may move on the manoeuvring area and apron only in accordance with the permission of the air traffic control unit at the aerodrome.

(3) Two red balls, 60 centimetres in diameter, positioned vertically one above the other, 60 centimetres apart and suspended from a mast, signify that glider flying is in progress at the aerodrome.

(4) Black, Arabic numerals in two-figure groups and, where parallel runways are provided, the letter or letters L (left), LC (left centre), C (centre), RC (right centre) and R (right), placed against a yellow background, indicate the direction for take-off or the runway in use.

(5) A black letter C against a yellow background, as illustrated in this paragraph,

**Status:** This is the original version (as it was originally made). This item of legislation is currently only available in its original format.

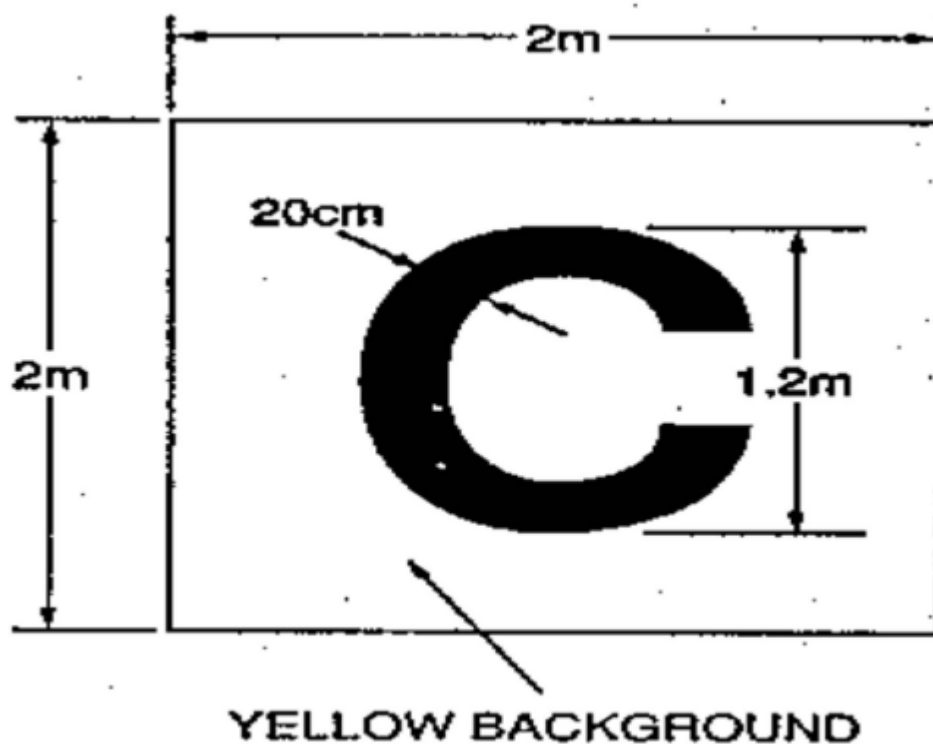

**Fig. 19**

indicates the position at which a pilot can report to the air traffic control unit or to the person in charge of the aerodrome.

(6) A rectangular green flag of not less than 60 centimetres square and not more than 66 centimetres square, flown from a mast, indicates that a right-hand circuit is in force.

**Lights and pyrotechnic signals for control of aerodrome traffic**

**60.** Each signal described in column 1 of Table 4 shall have the meanings respectively appearing in columns 2, 3 and 4 of the Table in the circumstances specified in the second row of the Table.

**Table 4—Meaning Of Lights And Pyrotechnic Signals**

<i>Column 1</i>	<i>Column 2</i>	<i>Column 3</i>	<i>Column 4</i>
<i>Characteristic and colour of light beam or pyrotechnic</i>	<i>Directed from an aerodrome to an aircraft in flight</i>	<i>Directed from an aerodrome to an aircraft or vehicle on the aerodrome</i>	<i>Directed from an aircraft in flight to an aerodrome</i>
(a) Continuous red light.	Give way to other aircraft and continue circling.	Stop.	—
(b) Red pyrotechnic light, or red flare.	Do not land; wait for permission.	—	Immediate assistance is required.

**Status:** This is the original version (as it was originally made). This item of legislation is currently only available in its original format.

<i>Column 1</i>	<i>Column 2</i>	<i>Column 3</i>	<i>Column 4</i>
<i>Characteristic and colour of light beam or pyrotechnic</i>	<i>Directed from an aerodrome to an aircraft in flight</i>	<i>Directed from an aerodrome to an aircraft or vehicle on the aerodrome</i>	<i>Directed from an aircraft in flight to an aerodrome</i>
(c) Red flashes.	Do not land; aerodrome not available for landing.	Move clear of landing area.	—
(d) Green flashes.	Return to aerodrome; wait for permission to land.	To an aircraft: you may move on the manoeuvring area and apron.  To a vehicle: you may move on the manoeuvring area.	—
(e) Continuous green light.	You may land.	You may take off (not applicable to a vehicle).	—
(f) Continuous green light, or green flashes, or green pyrotechnic light.	—	—	By night: May I land?  By day: May I land from direction different from that indicated by landing T?
(g) White flashes.	Land at the aerodrome after receiving continuous green light, and then, after receiving green flashes, proceed to the apron.	Return to starting point on the aerodrome.	I am compelled to land.
(h) White pyrotechnic lights.  Switching on and off the navigation lights.  Switching on and off the landing lights.	—	—	I am compelled to land.

### **Marshalling signals (from a marshaller to an aircraft)**

**61.—(1)** Each of the signals for the guidance of aircraft manoeuvring on or off the ground, described in column 1 of Table 5 and as illustrated in column 3, when given by a marshaller to an aircraft, shall have the meanings specified in column 2 of the Table.

(2) By day any such signals shall be given by hand or by circular bats and by night shall be given by torches or by illuminated wands.

**Status:** This is the original version (as it was originally made). This item of legislation is currently only available in its original format.

**Table 5—Meaning of Marshalling Signals (from a marshaller to an aircraft)**

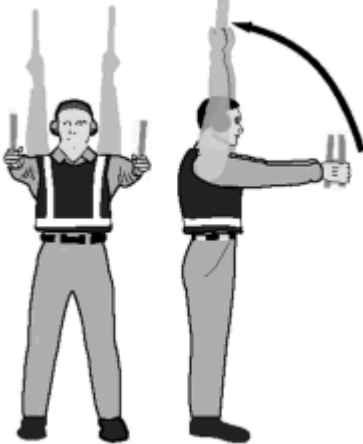
<i>Column 1</i> <i>Description of Signal</i>	<i>Column 2</i> <i>Meaning of signal</i>	<i>Column 3</i> <i>Illustration of signal</i>
1. Raise right hand above head level with wand pointing up; move left-hand wand pointing down toward body.	Wingwalker/guide — This signal provides an indication by a person positioned at the aircraft wing tip, to the pilot/marshaller/ push-back operator, that the aircraft movement on/off a parking position would be unobstructed.	
2. Raise fully extended arms straight above head with wands pointing up	Identify gate	

**Status:** This is the original version (as it was originally made). This item of legislation is currently only available in its original format.

<i>Column 1</i>	<i>Column 2</i>	<i>Column 3</i>
<i>Description of Signal</i>	<i>Meaning of signal</i>	<i>Illustration of signal</i>

3. Point both arms upward, move and extend arms outward to sides of body and point with wands to direction of next signalman or taxi area.

Proceed to next signalman or as directed by tower/ground control



4. Bend extended arms at elbows and move wands up and down from chest height to head.

Straight ahead





**Status:** This is the original version (as it was originally made). This item of legislation is currently only available in its original format.

<i>Column 1</i>	<i>Column 2</i>	<i>Column 3</i>
<i>Description of Signal</i>	<i>Meaning of signal</i>	<i>Illustration of signal</i>



5(a) With right arm and wand extended at a 90-degree angle to body, make “come ahead” signal with left hand. The rate of signal motion indicates to pilot the rate of aircraft turn.

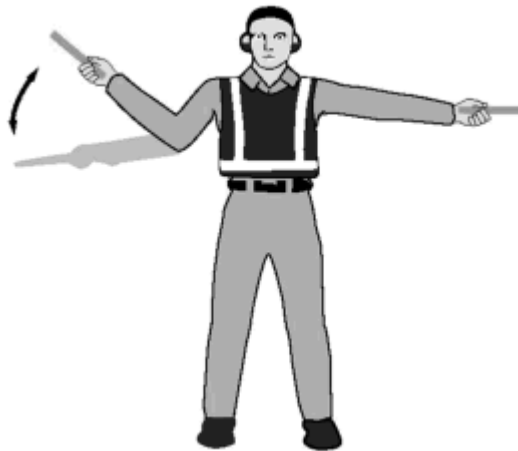

5(b) With left arm and wand extended at a 90-degree angle to body, make “come ahead” signal with right hand. The rate of signal motion indicates to pilot the rate of aircraft turn.

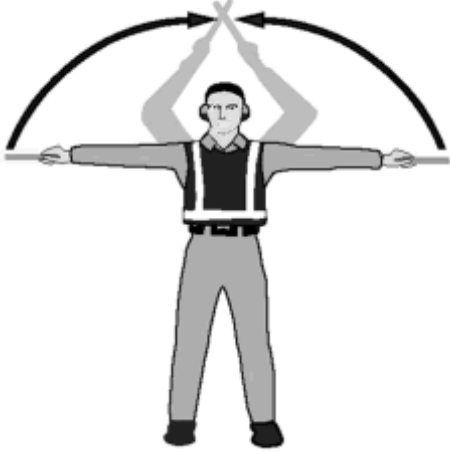

**Status:** This is the original version (as it was originally made). This item of legislation is currently only available in its original format.

Column 1	Column 2	Column 3
Description of Signal	Meaning of signal	Illustration of signal
<p>6(a) Fully extend arms and wands at a 90-degree angle to sides and slowly move to above head until wands cross.</p>	<p>Normal stop</p>	
<p>6(b) Abruptly extend arms and wands to top of head, crossing wands.</p>	<p>Emergency stop</p>	
<p>7(a) Raise hand just above shoulder height with open palm. Ensuring eye contact with flight crew, close hand into a fist. Do not move until receipt of “thumbs up” acknowledgement from flight crew.</p>	<p>Set brakes</p>	

**Status:** This is the original version (as it was originally made). This item of legislation is currently only available in its original format.

<i>Column 1</i>	<i>Column 2</i>	<i>Column 3</i>
<i>Description of Signal</i>	<i>Meaning of signal</i>	<i>Illustration of signal</i>
7(b) Raise hand just above shoulder height with hand closed in a fist. Ensuring eye contact with flight crew, open palm. Do not move until receipt of “thumbs up” acknowledgement from crew.	Release brakes	

8(a) With arms and wands fully extending above head, move wands inwards in a “jabbing” motion until wands touch. Ensure acknowledgement is received from flight crew.

Chocks inserted



**Status:** This is the original version (as it was originally made). This item of legislation is currently only available in its original format.

<i>Column 1</i>	<i>Column 2</i>	<i>Column 3</i>
<i>Description of Signal</i>	<i>Meaning of signal</i>	<i>Illustration of signal</i>

8(b) With arms and wands fully extended above head, move wands outward in “jabbing” motion. Do not remove chocks until authorised by crew.

Chocks removed



9. Raise right arm to head level with wand pointing up and start a circular motion with hand; at the same time, with left arm raised above head level, point to engine to be started.

Start engine(s)

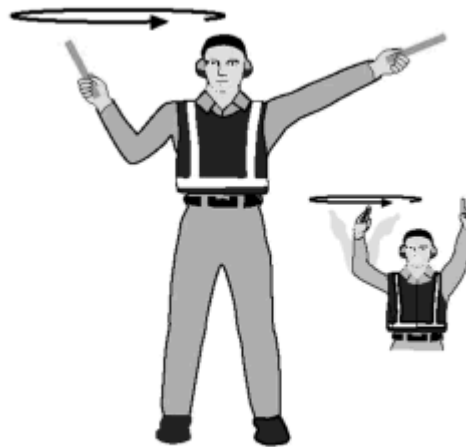

**Status:** This is the original version (as it was originally made). This item of legislation is currently only available in its original format.

<i>Column 1</i>	<i>Column 2</i>	<i>Column 3</i>
<i>Description of Signal</i>	<i>Meaning of signal</i>	<i>Illustration of signal</i>

10. Extend arm with wand forward of body at shoulder level; move hand and wand to top of left shoulder and draw wand to top of right shoulder in a slicing motion across throat.

Cut engine(s)



11. Move extended arms downwards in a “patting” gesture, moving wands up and down from waist to knees.

Slow down

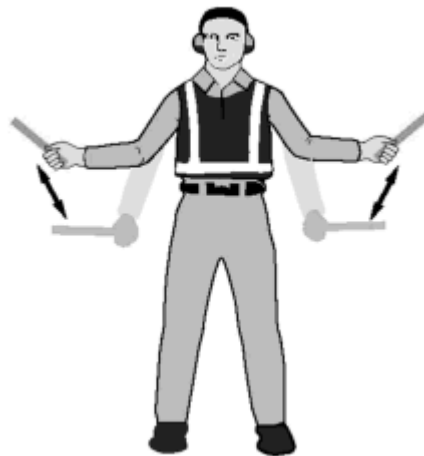

**Status:** This is the original version (as it was originally made). This item of legislation is currently only available in its original format.

<i>Column 1</i>	<i>Column 2</i>	<i>Column 3</i>
<i>Description of Signal</i>	<i>Meaning of signal</i>	<i>Illustration of signal</i>

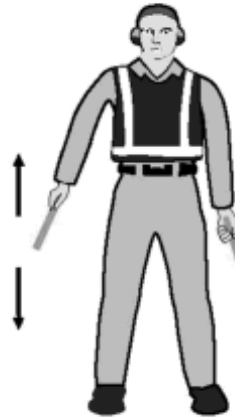

12. With arms down and wands toward ground, wave either right or left wand up and down indicating engine(s) on left or right side respectively should be slowed down.



13. With arms in front of body at waist height, rotate arms in a forward motion. To stop rearward movement, use signal 6(a) or 6(b).



**Status:** This is the original version (as it was originally made). This item of legislation is currently only available in its original format.

<i>Column 1</i>	<i>Column 2</i>	<i>Column 3</i>
<i>Description of Signal</i>	<i>Meaning of signal</i>	<i>Illustration of signal</i>
14(a) Point left arm with wand down and bring right arm from overhead vertical position to horizontal forward position, repeating right-arm movement.	Turns while backing (for tail to starboard)	
14(b) Point right arm with wand down and bring left arm from overhead vertical position to horizontal forward position, repeating left-arm movement.	Turns while backing (for tail to port)	

**Status:** This is the original version (as it was originally made). This item of legislation is currently only available in its original format.

<i>Column 1</i>	<i>Column 2</i>	<i>Column 3</i>
<i>Description of Signal</i>	<i>Meaning of signal</i>	<i>Illustration of signal</i>

15. Raise right arm to head level with wand pointing up or display hand with “thumbs up”; left arm remains at side by knee.

Affirmative/all clear— This signal is also used as a technical/servicing communication signal.

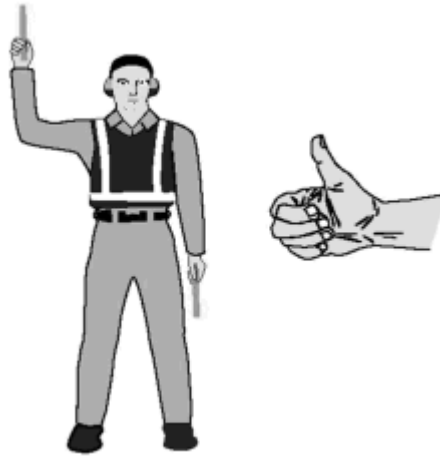

16. Fully extend arms and wands at a 90-degree angle to sides.

Hover





**Status:** This is the original version (as it was originally made). This item of legislation is currently only available in its original format.

<i>Column 1</i>	<i>Column 2</i>	<i>Column 3</i>
<i>Description of Signal</i>	<i>Meaning of signal</i>	<i>Illustration of signal</i>

17. Fully extend arms and wands at a 90-degree angle to sides and, with palms turned up, move hands upwards. Speed of movement indicates rate of ascent.

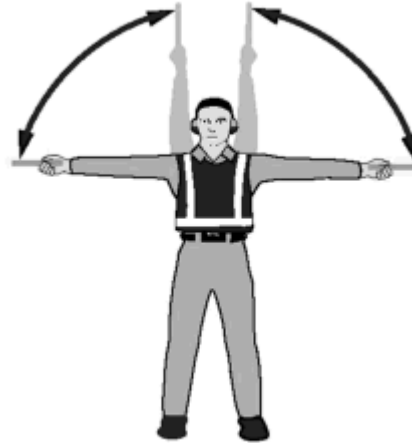

18. Fully extend arms and wands at a 90-degree angle to sides and, with palms turned down, move hands downwards. Speed of movement indicates rate of descent.

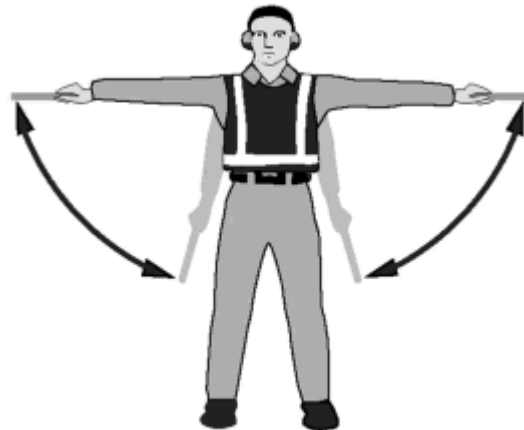

**Status:** This is the original version (as it was originally made). This item of legislation is currently only available in its original format.

<i>Column 1</i>	<i>Column 2</i>	<i>Column 3</i>
<i>Description of Signal</i>	<i>Meaning of signal</i>	<i>Illustration of signal</i>

19(a) Extend arm horizontally at a 90-degree angle to right side of body. Move other arm in same direction in a sweeping motion.

Move horizontally left (from pilot's point of view)



19(b) Extend arm horizontally at a 90-degree angle to left side of body. Move other arm in same direction in a sweeping motion.

Move horizontally right (from pilot's point of view)



**Status:** This is the original version (as it was originally made). This item of legislation is currently only available in its original format.

<i>Column 1</i>	<i>Column 2</i>	<i>Column 3</i>
<i>Description of Signal</i>	<i>Meaning of signal</i>	<i>Illustration of signal</i>

20. Cross arms with wands downwards and in front of body.

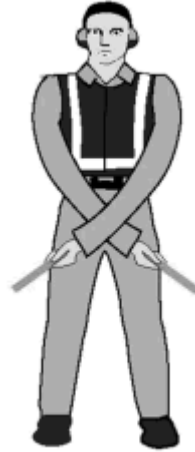

21. Move right-hand wand in a “fanning” motion from shoulder to knee, while at the same time pointing with left-hand wand to area of fire.

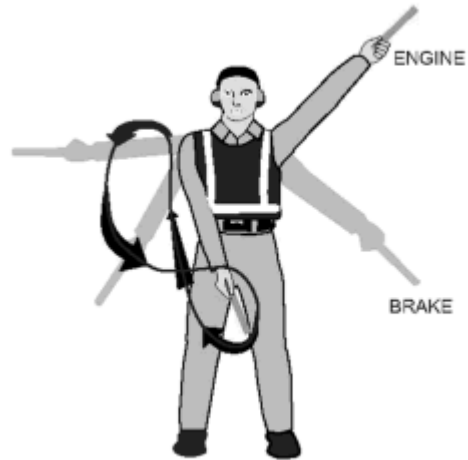

**Status:** This is the original version (as it was originally made). This item of legislation is currently only available in its original format.

<i>Column 1</i>	<i>Column 2</i>	<i>Column 3</i>
<i>Description of Signal</i>	<i>Meaning of signal</i>	<i>Illustration of signal</i>

22. Fully extend arms and wands downwards at a 45-degree angle to sides. Hold position until aircraft is clear for next manoeuvre.



23. Perform a standard salute with right hand and/or wand to dispatch the aircraft. Maintain eye contact with flight crew until aircraft has begun to taxi.



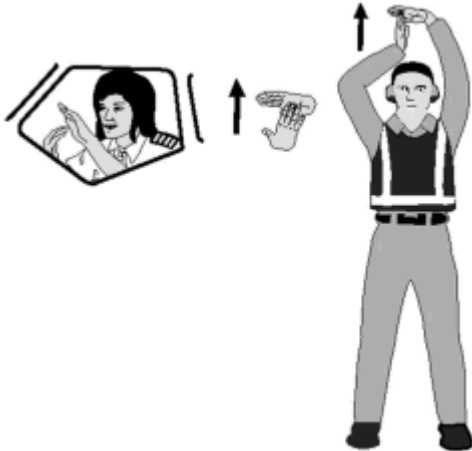

**Status:** This is the original version (as it was originally made). This item of legislation is currently only available in its original format.

Column 1	Column 2	Column 3
Description of Signal	Meaning of signal	Illustration of signal
<p>24. Extend right arm fully above head and close fist or hold wand in horizontal position; left arm remains at side by knee.</p>	<p>Do not touch controls (technical/servicing communication signal)</p>	
<p>25. Hold arms fully extended above head, open left hand horizontally and move finger tips of right hand into a touch open palm of left hand (forming a "T"). At night, illuminated wands can also be used to form the "T" above head.</p>	<p>Connect ground power (technical/servicing communication signal)</p>	

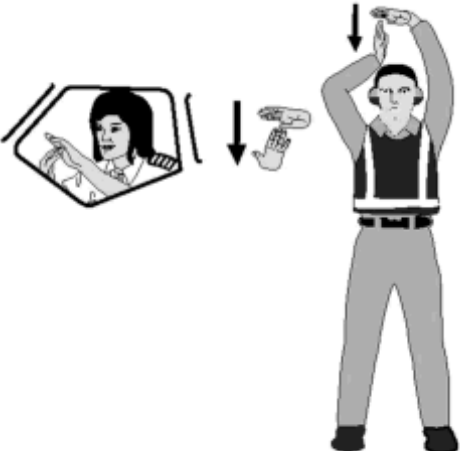
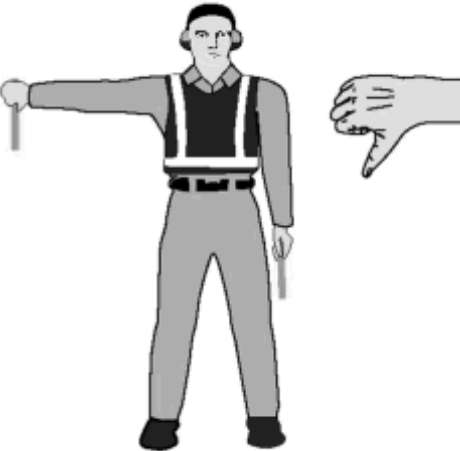
**Status:** This is the original version (as it was originally made). This item of legislation is currently only available in its original format.

Column 1	Column 2	Column 3
Description of Signal	Meaning of signal	Illustration of signal
<p>26. Hold arms fully extended above head with finger tips of right hand touching open horizontal palm of left hand (forming a “T”); then move right hand away from the left. Do not disconnect power until authorised by flight crew. At night illuminated wands can also be used to form the “T” above head.</p>	<p>Disconnect power (technical/servicing communication signal)</p>	
<p>27. Hold right arm straight out at 90 degrees from shoulder and point wand down to ground or display hand with “thumbs down”; left hand remains at side by knee.</p>	<p>Negative (technical/servicing communication signal)</p>	

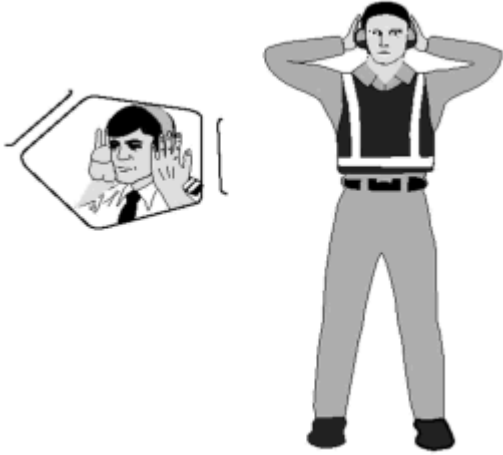
**Status:** This is the original version (as it was originally made). This item of legislation is currently only available in its original format.

<i>Column 1</i>	<i>Column 2</i>	<i>Column 3</i>
<i>Description of Signal</i>	<i>Meaning of signal</i>	<i>Illustration of signal</i>
28. Extend both arms at 90 degrees from body and move hands to cup both ears.	Establish communication via interphone (technical/servicing communication signal)	
29. With right arm at side and left arm raised above head at a 45-degree angle, move right arm in a sweeping motion towards top of left shoulder.	Open/close stairs (technical/servicing communication signal) —This signal is intended mainly for aircraft with the set of integral stairs at the front	

**Marshalling signals (from a pilot of an aircraft to a marshaller)**

62. Each of the signals described in column 1 of Table 6, when made by a pilot in an aircraft to a marshaller on the ground, shall have the meanings specified in column 2 of the Table.

**Table 6—Meaning of Marshalling Signals (from a pilot of an aircraft to a marshaller)**

<i>Column 1</i>	<i>Column 2</i>
<i>Description of Signal</i>	<i>Meaning of Signal</i>
1. Raise arm and hand with fingers extended horizontally in front of face, then clench fist.	Brakes engaged.
2. Raise arm with fist clenched horizontally in front of face, then extend fingers.	Brakes released.
3. Arms extended palms facing outwards, move hands inwards to cross in front of face.	Insert chocks.

**Status:** This is the original version (as it was originally made). This item of legislation is currently only available in its original format.

<i>Column 1</i>	<i>Column 2</i>
<i>Description of Signal</i>	<i>Meaning of Signal</i>
4. Hands crossed in front of face, palms facing outwards, move arms outwards.	Remove chocks.
5. Raise the number of fingers on one hand indicating the number of the engine to be started. For this purpose the aircraft engines shall be numbered in relation to the marshaller facing the aircraft, from his right to his left. For example, No. 1 engine shall be the port outer engine, No. 2 engine shall be the port inner engine, No. 3 engine shall be the starboard inner engine and No. 4 engine shall be the starboard outer engine.	Ready to start engines.

### **Distress, urgency and safety signals**

**63.**—(1) The following signals, given either together or separately before the sending of a message, signify that an aircraft is threatened by grave and imminent danger and requests immediate assistance—

- (a) by radiotelephony—
  - the spoken word ‘MAYDAY’;
- (b) by visual signalling—
  - (i) the signal SOS (... --- ...);
  - (ii) a succession of pyrotechnic lights fired at short intervals each showing a single red light;
  - (iii) a parachute flare showing a red light;
- (c) by sound signalling other than radiotelephony—
  - (i) the signal SOS (... --- ...);
  - (ii) a continuous sounding with any sound apparatus.

(2) The following signals, given either together or separately, before the sending of a message, signify that the pilot-in-command of the aircraft wishes to give notice of difficulties which compel it to land but that he does not require immediate assistance—

- (a) a succession of white pyrotechnic lights;
- (b) the repeated switching on and off of the aircraft landing lights;
- (c) the repeated switching on and off of its navigation lights, in such a manner as to be clearly distinguishable from the flashing navigation lights described in rule 49.

(3) The following signals, given either together or separately, indicate that the pilot-in-command of the aircraft has an urgent message to transmit concerning the safety of a ship, aircraft, vehicle or other property or of a person on board or within sight of the aircraft from which the signal is given—

- (a) by radiotelephony—
  - the repeated spoken word, ‘PAN PAN’;
- (b) by visual signalling—
  - the signal XXX (- .. -- .. -- .. -);
- (c) by sound signalling other than radiotelephony—
  - the signal XXX (- .. -- .. -- .. -).



## SCHEDULE 5

Article 185

## PENALTIES

## PART A

## Provisions Referred to in Article 185(5)

<i>Article of order</i>	<i>Subject matter</i>
14	Aircraft flying unregistered
22	Aircraft flying with false or incorrect markings
29	Flight without appropriate maintenance
30	Failure to keep a technical log or other log books
32	Flight without a certificate of release to service issued under the Order
33	Exercise of privileges of aircraft maintenance engineer's licence whilst unfit
35	Flight without required equipment
36	Flight without required radio equipment
37	Minimum equipment requirements
38	Requirement to weigh aircraft and keep weight schedule
40-43	Crew requirements
44	Requirement for appropriate licence
52(1) and (4)	Requirement for appropriate certificate of test or experience
53	Requirement for appropriate certificate of test
54	Flight without valid medical certificate
55	Flight in unfit condition
56	Prohibition of flight after failure of test
59	Instruction in flying without appropriate licence and rating
62(6)	Operator's obligation to obtain flight time records of flight crew
63(2)	Flight crew member's obligation to inform operator of flight times
64	Flight time limitations
67	Breach of the Rules of the Air
68	Flight in contravention of restriction of flying regulations
69	Flying displays
70-72	Flight by balloons, gliders, kites, parascending parachutes and airships
73	Flight by small aircraft

**Status:** This is the original version (as it was originally made). This item of legislation is currently only available in its original format.

<i>Article of order</i>	<i>Subject matter</i>
75	Aerodrome operating minima – non-commercial air transport aircraft
76	Requirement for pilot to remain at controls
78	Pre-flight action by pilot-in-command of aircraft
79	Requirement for passenger briefing
82	Requirements for radio station in aircraft to be licensed and for operation of same
83	Requirement for an airborne collision avoidance system
84	Use of flight recording systems and preservation of records
86	Carriage of persons in or on any part of an aircraft not designed for that purpose
87 and 88	Requirement for exits and break-in markings
89	Requirement for area navigation equipment – aircraft registered in the Territory
90	Requirement for area navigation equipment – aircraft registered elsewhere than in the Territory
91	Requirement for minimum navigation performance equipment
92	Requirement for height keeping performance equipment – aircraft registered in the Territory
93	Requirement for height keeping performance equipment – aircraft registered elsewhere than in the Territory
96	Operations manual requirement
97	Training programme requirement
98	Safety management system and flight data monitoring
99	Operator’s responsibilities in connection with crew
100	Requirements for loading aircraft
101	Operational restrictions on aeroplanes
102	Operational restrictions on helicopters
103	Prohibition on commercial air transport flights at night or in Instrument Meteorological Conditions by single engine aeroplanes
104	Aerodrome operating minima – commercial air transport aircraft registered in the Territory
105	Aerodrome operating minima – commercial air transport aircraft registered elsewhere than in the Territory
128	Requirement for aerial application permission
129	Towing, picking up and raising of persons and articles by aircraft
130	Dropping of articles and animals from aircraft
131	Dropping of persons

<i>Article of order</i>	<i>Subject matter</i>
133	Requirement for approval
138	Provision of air traffic control services
139	Duty of person in charge to satisfy himself as to competence of controllers
142	Use of radio call signs at aerodromes
143	Requirement for licensing of air traffic controllers
151	Requirement for licensing of flight information service officers
152	Requirement for aerodrome information service manual
153	Use of aeronautical telecommunications service
154	Requirement to keep aeronautical telecommunications service records
155	Requirement for certificated aerodrome
156	Contravention of conditions of aerodrome certificate – use of aerodromes
162	Management of aviation fuel at aerodromes
163	Use of aeronautical lights
165	Prohibition of dangerous lights
174(4), (7) and (10)	Requirement to report occurrences
179	Prohibition of smoking in aircraft
180	Requirement to obey lawful commands of aircraft pilot-in-command
181	Acting in a disruptive manner
182	Obstruction of persons performing duties under the Order
184	Prohibition of stowaways

## PART B

### Provisions Referred to in Article 185(6)

<i>Article of order</i>	<i>Subject matter</i>
8	Flight in contravention of direction not to fly
24	Flight without a certificate of airworthiness
62(1)	Operator's obligation to regulate flight times of flight crew
62(5)	Operator's obligation not to allow flight by crew in dangerous state of fatigue
63(1)	Crew's obligation not to fly in dangerous state of fatigue
65	Protection of air crew from cosmic radiation

**Status:** This is the original version (as it was originally made). This item of legislation is currently only available in its original format.

<i>Article of order</i>	<i>Subject matter</i>
66	Keeping and production of records of exposure to cosmic radiation
74	Operation of aircraft
94	Flight for the purpose of commercial air transport without an air operator's certificate
95	Flight in the service of a police authority without a police air operator's certificate
107	Prohibition of carriage of weapons and munitions of war
110	Prohibition of carriage of dangerous goods
135	Restriction of flights for valuable consideration by aircraft registered elsewhere than in the Territory
137	Restriction of flights for aerial photography, aerial survey and aerial work by aircraft registered elsewhere than in the Territory
138	Provision of an air traffic control service without an approval
148	Prohibition of drunkenness etc of controllers
149	Controller's obligation not to act in a dangerous state of fatigue
162(4)	Use of aviation fuel which is unfit for use in aircraft
173	Use of false or unauthorised documents and records
174(9)	Making false reports
176	Endangering safety of aircraft
177	Endangering safety of persons or property
178	Prohibition of drunkenness in aircraft
181	Acting in disruptive manner and intentional interference
186	Operators' or pilot-in-commands' obligations in respect of flights over any foreign country

## SCHEDULE 6

Article 187

## TERRITORIES TO WHICH THIS ORDER APPLIES

Anguilla  
 Bermuda  
 British Indian Ocean Territory  
 Cayman Islands  
 Falkland Islands  
 Montserrat  
 Pitcairn, Henderson, Ducie and Oeno Islands  
 St. Helena, Ascension and Tristan da Cunha  
 South Georgia and the South Sandwich Islands

Sovereign Base Areas of Akrotiri and Dhekelia  
Turks and Caicos Islands  
Virgin Islands

---

## EXPLANATORY NOTE

*(This note is not part of the Order)*

This Order supersedes the Air Navigation (Overseas Territories) Order 2007 (S.I. 2007 No. 3468) as amended (“the 2007 Order”).

1. This Order sets out the provisions applicable to the Overseas Territories listed in Schedule 6 to enable the United Kingdom to comply with the Convention on International Civil Aviation (known as the Chicago Convention) and, in particular, the Annexes to that Convention. This Order replaces the Air Navigation (Overseas Territories) Order 2007 (S.I. 2007/3468), the [Air Navigation \(Overseas Territories\) \(Amendment\) Order 2008 \(S.I. 2008/3125\)](#) and the Air Navigation (Overseas Territories) (Amendment) Order 2011 (S.I. 2011/237).

2. The general approach is to try to make this Order as user-friendly as possible; taking account of the fact that it is a legal instrument and taking account of Statutory Instrument and Government (Better Regulation) Practice. This has involved in particular—

- replacement of unnecessarily legalistic terms and expressions by more commonplace ones – such as “under” in place of “pursuant to” when referring to an article;
- splitting-up long articles with many paragraphs into a number of shorter articles (for example articles 4 and 20 in the 2007 Order);
- reduction in the length and complexity of sentences;
- removing specifications, procedures, details of content (for example in manuals) where adequate provision is made in corresponding Overseas Territories Aviation Requirements (“OTAR”) Parts;
- repeal of some of the Schedules if their content is fully included in the relevant OTAR Parts;
- replacement of “shall” by “must”, where an obligation or prohibition is imposed in the Order upon a person or organisation;
- implementation of gender-neutral drafting; that is avoiding the use of gender specific terms such as “he” and replacement with a gender-neutral alternative such as “the holder”, when referring to a licence or certificate holder;
- modernisation of language generally.

3. As this is intended to be the last major amendment to the regime the opportunity has been taken to carry out some restructuring of it so that its provisions follow a more logical sequence. In particular, the principal powers and duties vested in the Governor have been brought from the General Provisions – Part XVII – in the 2007 Order to a new Part 1 to give them greater visibility and prominence and the Interpretation article (article 156 in the 2007 Order) has been brought to the front, as article 3 of this Order.

*Status: This is the original version (as it was originally made). This item of legislation is currently only available in its original format.*

**4.** Registration of aircraft: there is one substantive change relating to the qualifying requirements for registration upon which extensive consultations have taken place: the requirements for the applicant's principal place of business (in addition to its registered office) to be located in the Territory has been removed, coupled with removal of references to "the Commonwealth" (article 16). It is generally accepted that the previous provisions were somewhat archaic and that, provided that the applicant is incorporated in a Territory, there is no need for that applicant to have its principal place of business there in order to ensure effective oversight. Apart from the above, the previous lengthy article (containing 17 paragraphs) has been divided into seven separate articles (articles 15-21).

**5.** Equipment of aircraft: this article has been amended by deleting the specific details of the type of instructions to be given regarding the actions to be taken in an emergency. The specific form of such instructions is for the operator to determine according to the type and size of the aircraft, unless otherwise specified in the relevant OTAR Part (article 35).

**6.** Minimum equipment requirements: this article has been revised to make it clear that the operator's Minimum Equipment List ("MEL") requires approval by the regulatory authority (article 37).

**7.** Composition of crew of aircraft: this article has been broken up into separate elements coupled with the removal of references to pressurisation in relation to crewing requirements and the removal of the provisions relating to flight navigators and flight engineers, neither of which are required on the types of modern aircraft that populate the Territories' registers (articles 40-43). The provisions relating to cabin crew have been placed in a separate article (article 42).

**8.** In relation to restrictions on flying, the term "issue instructions" has been substituted for the term "make regulations" so as to enable the Governor's to act without the need for adoption of the formal process of making and gazetting regulations (article 68).

**9.** The provisions relating to the increasing unmanned aerial activities have been revised to mirror those applicable in the UK itself and the definition has been revised in line with current International Civil Aviation Organisation practice (articles 3, 73, 191).

**10.** The provisions relating to weapons and munitions of war have been separated so as to distinguish clearly between purely sporting weapons and those used for military purposes (article 107 to 109).

**11.** The provisions relating to the transport of dangerous goods by air were previously contained in Schedule 10. The principal obligations and prohibitions contained in that schedule have been lifted up into the body of the Order and the technical instructions and implementing requirements have been set out in OTAR Part 92 (Part 12 and articles 110 to 125).

**12.** There have been some revisions to the performance requirements relating to aircraft in order to align them more closely with the ICAO Standards and with the provisions contained in the Operations OTARs Parts 91, 121 and 135 (articles 101 and 102).

**13.** The aerial works provisions have been re-written and re-structured in order to separate the different types of activity and in order to impose requirements relating to the assessment of risk and the development of standard operating procedures as an alternative to an operations manual (articles 126 to 131 and article 137).

**14.** The articles relating to aeronautical telecommunications were considered to be too complex and cumbersome and have been restructured with the removal of many of the implementing requirements to the relevant OTAR Part (articles 153 and 154).

**15.** The article relating to the use of aerodromes has been revised in the light of experience and in the context of the development in the Territories of water-borne aircraft operations. The provisions have been revised accordingly so as to apply to aerodromes generally whilst the onus

**Status:** This is the original version (as it was originally made). This item of legislation is currently only available in its original format.

remains upon the aircraft operator to satisfy itself as to their suitability for the proposed operations. The complementary article has been revised accordingly (articles 155 and 156).

### TABLE OF COMPARISON

(This Table is not part of the Order)

The following Table shows, in relation to each article of the Air Navigation (Overseas Territories) Order 2007, as amended, the article of the 2013 Order in which it is reproduced.

<i>2007 Order as amended</i>	<i>2013 Order</i>
1	1
2	2
156	3
149	4
152	5
153	6
155	7
141	8
142	9
146	10
122	11
123	12
154	13
3	14
4(1) and (2)	15
4(3) to (5)	16
4(6) to (8)	17
4(9) to (12)	18
4(13) to (15)	19
4(16)	20
4(17)	21
5	22
6	23
7	24
8	25
10	26
8	27
9	28
9	29

**Status:** This is the original version (as it was originally made). This item of legislation is currently only available in its original format.

<i>2007 Order as amended</i>	<i>2013 Order</i>
11	30
11	31
12	32
13	33
14	34
15	35
16	36
17	37
18	38
19	39
20	40
20	41
20	42
20	43
21	44
21	45
21	46
21	47
21	48
21	49
21	50
22	51
23	52
24	53
25	54
25	55
26	56
27	57
28	58
29	59
30	60
31	61
32	62
33	63



**Status:** This is the original version (as it was originally made). This item of legislation is currently only available in its original format.

<i>2007 Order as amended</i>	<i>2013 Order</i>
34	64
35	65
36	66
37	67
38	68
63	69
39	70
39	71
39	72
40	73
41	74
42	75
43	76
44	77
45	78
46	79
47	80
48	81
49	82
55	83
56	84
59	85
60	86
61	87
62	88
50	89
51	90
52	91
53	92
54	93
64	94
65	95
66	96
68	97

**Status:** This is the original version (as it was originally made). This item of legislation is currently only available in its original format.

<i>2007 Order as amended</i>	<i>2013 Order</i>
69	98
70	99
71	100
72	101
73	102
74	103
75	104
76	105
77	106
57(1), (3) and (4)	107
57(2), (5) and (6)	108
57(7)	109
58 and Schedule 10, regulations 2, 18 and 19	110
Schedule 10, regulation 3	111
Schedule 10, regulation 4	112
Schedule 10, regulation 5	113
Schedule 10, regulation 6	114
Schedule 10, regulations 7 and 8	115
Schedule 10, regulation 9	116
Schedule 10, regulation 10	117
Schedule 10, regulation 11	118
Schedule 10, regulation 12	119
Schedule 10, regulation 13	120
Schedule 10, regulation 14	121
Schedule 10, regulation 14	122
Schedule 10, regulation 16	123
Schedule 10, regulation 17	124
Schedule 10, regulation 1	125
78	126
78	127
78	128
80	129
81	130
82	131

**Status:** This is the original version (as it was originally made). This item of legislation is currently only available in its original format.

<i>2007 Order as amended</i>	<i>2013 Order</i>
83	132
84	133
85	134
135	135
136	136
137	137
86	138
87	139
88	140
89	141
90	142
91	143
92	144
93	145
94	146
95	147
96	148
97	149
99	150
98	151
100	152
101	153
102	154
105	155
103	156
106	157
107	158
108	159
109	160
113	161
114	162
110	163
111	164
112	165

**Status:** This is the original version (as it was originally made). This item of legislation is currently only available in its original format.

<i>2007 Order as amended</i>	<i>2013 Order</i>
115	166
116	167
117	168
118	169
119	170
120	171
121	172
124	173
139	174
140	175
125	176
126	177
127	178
128	179
129	180
130	181
131	182
132	183
133	184
134	185
138	186
148	187
143	188
144	189
145	190
150	191
151	192
147	193
164	194
157	195
158	196
159	197
160	198
161	199

**Status:** This is the original version (as it was originally made). This item of legislation is currently only available in its original format.

<i>2007 Order as amended</i>	<i>2013 Order</i>
162	200
163	201
163	202