

Council Regulation (EEC) No 3821/85 of 20 December  
1985 on recording equipment in road transport

COUNCIL REGULATION (EEC) No 3821/85  
of 20 December 1985  
on recording equipment in road transport

THE COUNCIL OF THE EUROPEAN COMMUNITIES,

Having regard to the Treaty establishing the European Economic Community, and in particular Article 75 thereof,

Having regard to the proposal from the Commission<sup>(1)</sup>,

Having regard to the opinion of the European Parliament<sup>(2)</sup>,

Having regard to the opinion of the Economic and Social Committee<sup>(3)</sup>,

Whereas Regulation (EEC) No 1463/70<sup>(4)</sup> as last amended by Regulation (EEC) No 2828/77<sup>(5)</sup> introduced recording equipment in road transport;

Whereas, taking into account the amendments set out hereinafter, in order to clarify matters, all the relevant provisions should be brought together in a single text, and in consequence thereof, Regulation (EEC) No 1463/70 of the Council should be repealed; whereas, however, the exemptions set out in Article 3 (1) for certain passenger services should be maintained in force for a certain time;

Whereas the use of recording equipment that may indicate the periods of time referred to in Regulation (EEC) No 3820/85 on the harmonization of certain social legislation relating to road transport<sup>(6)</sup> is intended to ensure effective checking on that social legislation;

Whereas the obligation to use such recording equipment can be imposed only for vehicles registered in Member States; whereas furthermore certain of such vehicles may, without giving rise to difficulty, be excluded from the scope of this Regulation;

Whereas the Member States should be entitled, with the Commission's authorization, to grant certain vehicles exemptions from the provisions of the Regulation in exceptional circumstances; whereas, in urgent cases, it should be possible to grant these exemptions for a limited time without prior authorization from the Commission;

Whereas, in order to ensure effective checking, the equipment must be reliable in operation, easy to use and designed in such a way as to minimize any possibility of fraudulent use; whereas to this end recording equipment should in particular be capable of providing, on separate sheets for each driver and in a sufficiently precise and easily readable form, recorded details of the various periods of time;

Whereas automatic recording of other details of a vehicle's journey, such as speed and distance covered, will contribute significantly to road safety and will encourage sensible driving of the

---

*Changes to legislation: There are currently no known outstanding effects for the Council Regulation (EEC) No 3821/85. (See end of Document for details)*

---

vehicle; whereas, consequently, it appears appropriate to provide for the equipment also to record those details;

Whereas it is necessary to set Community construction and installation standards for recording equipment and to provide for an EEC approval procedure, in order to avoid throughout the territory of the Member States any impediment to the registration of vehicles fitted with such recording equipment, to their entry into service or use, or to such equipment being used;

Whereas, in the event of differences of opinion between Member States concerning cases of EEC type approval, the Commission should be empowered to take a decision on a dispute within six months if the States concerned have been unable to reach a settlement;

Whereas it would be helpful in implementing this Regulation and preventing abuses to issue drivers who so request with a copy of their record sheets;

Whereas, in order to achieve the aims hereinbefore mentioned of keeping a check on work and rest periods, it is necessary that employers and drivers be responsible for seeing that the equipment functions correctly and that they perform with due care the operations prescribed;

Whereas the provisions governing the number of record sheets that a driver must keep with him must be amended following the replacement of the flexible week by a fixed week;

Whereas technical progress necessitates rapid adaptation of the technical specifications set out in the Annexes to this Regulation; whereas, in order to facilitate the implementation of the measures necessary for this purpose, provision should be made for a procedure establishing close cooperation between the Member States and the Commission within an Advisory Committee;

Whereas Member States should exchange the available information on breaches established;

Whereas, in order to ensure that recording equipment functions reliably and correctly, it is advisable to lay down uniform requirements for the periodic checks and inspections to which the equipment is to be subject after installation,

HAS ADOPTED THIS REGULATION:

## CHAPTER I

### **Principles and scope**

#### *Article 1*

Recording equipment within the meaning of this Regulation shall, as regards construction, installation, use and testing, comply with the requirements of this Regulation [<sup>F1</sup>and of Annexes I or IB and II thereto], which shall form an integral part of this Regulation.

---

**Changes to legislation:** There are currently no known outstanding effects for the Council Regulation (EEC) No 3821/85. (See end of Document for details)

---

#### Textual Amendments

- F1** Substituted by Council Regulation (EC) No 2135/98 of 24 September 1998 amending Regulation (EEC) No 3821/85 on recording equipment in road transport and Directive 88/599/EEC concerning the application of Regulations (EEC) No 3820/85 and (EEC) No 3821/85.

### *[<sup>F2</sup>Article 2*

For the purpose of this Regulation the definitions set out in Article 4 of Regulation (EC) No 561/2006 of the European Parliament and of the Council of 15 March 2006 on the harmonisation of certain social legislation relating to road transport and amending Council Regulations (EEC) No 3821/85 and (EC) No 2135/98<sup>(7)</sup> shall apply.]

#### Textual Amendments

- F2** Substituted by Regulation (EC) No 561/2006 of the European Parliament and of the Council of 15 March 2006 on the harmonisation of certain social legislation relating to road transport and amending Council Regulations (EEC) No 3821/85 and (EC) No 2135/98 and repealing Council Regulation (EEC) No 3820/85 (Text with EEA relevance).

### *Article 3*

[<sup>F21</sup> Recording equipment shall be installed and used in vehicles registered in a Member State which are used for the carriage of passengers or goods by road, except the vehicles referred to in Article 3 of Regulation (EC) No 561/2006. Vehicles referred to in Article 16(1) of Regulation (EC) No 561/2006 and vehicles, which were exempt from the scope of application of Regulation (EEC) No 3820/85, but which are no longer exempt under Regulation (EC) No 561/2006 shall have until 31 December 2007 to comply with this requirement.

2 Member States may exempt vehicles mentioned in Articles 13(1) and (3) of Regulation (EC) No 561/2006 from application of this Regulation.

3 Member States may, after authorisation by the Commission, exempt from application of this Regulation vehicles used for the transport operations referred to in Article 14 of Regulation (EC) No 561/2006.]

4 In the case of national transport operations, Member States may require the installation and use of recording equipment in accordance with this Regulation in any of the vehicles for which its installation and use are not required by paragraph 1.

#### Textual Amendments

- F2** Substituted by Regulation (EC) No 561/2006 of the European Parliament and of the Council of 15 March 2006 on the harmonisation of certain social legislation relating to road transport and amending Council Regulations (EEC) No 3821/85 and (EC) No 2135/98 and repealing Council Regulation (EEC) No 3820/85 (Text with EEA relevance).

---

*Changes to legislation: There are currently no known outstanding effects for the Council Regulation (EEC) No 3821/85. (See end of Document for details)*

---

## CHAPTER II

### Type approval

#### Article 4

[<sup>F3</sup>For the purposes of this Chapter, the words ‘recording equipment’ shall mean ‘recording equipment or its components’.]

Applications for EEC approval of a type of recording equipment or of a model record sheet [<sup>F3</sup>or memory card shall be submitted, accompanied by the appropriate specifications, by the manufacturer or his agent to a Member State. No application in respect of any one type of recording equipment or of any one model record or memory card] sheet may be submitted to more than one Member State.

#### Textual Amendments

- F3** Inserted by [Council Regulation \(EC\) No 2135/98 of 24 September 1998 amending Regulation \(EEC\) No 3821/85 on recording equipment in road transport and Directive 88/599/EEC concerning the application of Regulations \(EEC\) No 3820/85 and \(EEC\) No 3821/85.](#)

#### Article 5

[<sup>F1</sup>A Member State shall grant EC component type-approval to any type of recording equipment, to any model record sheet or memory card which conforms to the requirements laid down in Annex I or IB to this Regulation, provided the Member State is in a position to check that production models conform to the approved type.]

[<sup>F4</sup>The system's security must comply with the technical requirements laid down in Annex IB. The Commission shall ensure that the said Annex stipulates that recording equipment may not be granted EC component type-approval until the whole system (the recording equipment itself, driver card and electrical gearbox connections) has demonstrated its capacity to resist attempts to tamper with or alter the data on driving times. Those measures, designed to amend non-essential elements of this Regulation, shall be adopted in accordance with the regulatory procedure with scrutiny referred to in Article 18(2). The tests necessary to establish this shall be carried out by experts familiar with up-to-date tampering techniques.]

Any modifications or additions to an approved model must receive additional EEC type approval from the Member State which granted the original EEC type approval.

#### Textual Amendments

- F1** Substituted by [Council Regulation \(EC\) No 2135/98 of 24 September 1998 amending Regulation \(EEC\) No 3821/85 on recording equipment in road transport and Directive 88/599/EEC concerning the application of Regulations \(EEC\) No 3820/85 and \(EEC\) No 3821/85.](#)
- F4** Substituted by [Regulation \(EC\) No 219/2009 of the European Parliament and of the Council of 11 March 2009 adapting a number of instruments subject to the procedure referred to in Article 251 of the Treaty to Council Decision 1999/468/EC with regard to the regulatory procedure with scrutiny Adaptation to the regulatory procedure with scrutiny — Part Two.](#)



---

**Changes to legislation:** There are currently no known outstanding effects for the Council Regulation (EEC) No 3821/85. (See end of Document for details)

---

### Article 6

Member States shall issue to the applicant an EEC approval mark, which shall conform to the model shown in Annex II, for each type of recording equipment or model record sheet [<sup>F3</sup>or memory card] which they approve pursuant to Article 5.

#### Textual Amendments

- F3** Inserted by [Council Regulation \(EC\) No 2135/98 of 24 September 1998 amending Regulation \(EEC\) No 3821/85 on recording equipment in road transport and Directive 88/599/EEC concerning the application of Regulations \(EEC\) No 3820/85 and \(EEC\) No 3821/85.](#)

### Article 7

The competent authorities of the Member State to which the application for type approval has been submitted shall, in respect of each type of recording equipment or model record sheet [<sup>F3</sup>or memory card] which they approve or refuse to approve, either send within one month to the authorities of the other Member States a copy of the approval certificate accompanied by copies of the relevant specifications, or, if such is the case, notify those authorities that approval has been refused; in cases of refusal they shall communicate the reasons for their decision.

#### Textual Amendments

- F3** Inserted by [Council Regulation \(EC\) No 2135/98 of 24 September 1998 amending Regulation \(EEC\) No 3821/85 on recording equipment in road transport and Directive 88/599/EEC concerning the application of Regulations \(EEC\) No 3820/85 and \(EEC\) No 3821/85.](#)

### Article 8

1 If a Member State which has granted EEC type approval as provided for in Article 5 finds that certain recording equipment or record sheets [<sup>F3</sup>or memory cards] bearing the EEC type approval mark which it has issued do not conform to the prototype which it has approved, it shall take the necessary measures to ensure that production models conform to the approved prototype. The measures taken may, if necessary, extend to withdrawal of EEC type approval.

2 A Member State which has granted EEC type approval shall withdraw such approval if the recording equipment or record sheet [<sup>F3</sup>or memory card] which has been approved is not in conformity with this Regulation or its Annexes or displays in use any general defect which makes it unsuitable for the purpose for which it is intended.

3 If a Member State which has granted EEC type approval is notified by another Member State of one of the cases referred to in paragraphs 1 and 2, it shall also, after consulting the latter Member State, take the steps laid down in those paragraphs, subject to paragraph 5.

4 A Member State which ascertains that one of the cases referred to in paragraph 2 has arisen may forbid until further notice the placing on the market and putting into service of the recording equipment or record sheets [<sup>F3</sup>or memory cards]. The same applies in the cases mentioned in paragraph 1 with respect to recording equipment or record sheets or memory cards] which have been exempted from EEC initial verification, if the manufacturer, after due warning, does not bring the equipment into line with the approved model or with the requirements of this Regulation.

---

*Changes to legislation:* There are currently no known outstanding effects for the Council Regulation (EEC) No 3821/85. (See end of Document for details)

---

In any event, the competent authorities of the Member States shall notify one another and the Commission, within one month, of any withdrawal of EEC type approval or of any other measures taken pursuant to paragraphs 1, 2 and 3 and shall specify the reasons for such action.

5 If a Member State which has granted an EEC type approval disputes the existence of any of the cases specified in paragraphs 1 or 2 notified to it, the Member States concerned shall endeavour to settle the dispute and the Commission shall be kept informed.

If talks between the Member States have not resulted in agreement within four months of the date of the notification referred to in paragraph 3 above, the Commission, after consulting experts from all Member States and having considered all the relevant factors, e.g. economic and technical factors, shall within six months adopt a decision which shall be communicated to the Member States concerned and at the same time to the other Member States. The Commission shall lay down in each instance the time limit for implementation of its decision.

#### **Textual Amendments**

- F3** Inserted by [Council Regulation \(EC\) No 2135/98 of 24 September 1998 amending Regulation \(EEC\) No 3821/85 on recording equipment in road transport and Directive 88/599/EEC concerning the application of Regulations \(EEC\) No 3820/85 and \(EEC\) No 3821/85.](#)

#### *Article 9*

1 An applicant for EEC type approval of a model record sheet shall state on his application the type or types of recording equipment on which the sheet in question is designed to be used and shall provide suitable equipment of such type or types for the purpose of testing the sheet.

2 The competent authorities of each Member State shall indicate on the approval certificate for the model record sheet the type or types of recording equipment on which that model sheet may be used.

#### *Article 10*

No Member State may refuse to register any vehicle fitted with recording equipment, or prohibit the entry into service or use of such vehicle for any reason connected with the fact that the vehicle is fitted with such equipment, if the equipment bears the EEC approval mark referred to in Article 6 and the installation plaque referred to in Article 12.

#### *Article 11*

All decisions pursuant to this Regulation refusing or withdrawing approval of a type of recording equipment or model record sheet [<sup>F3</sup>or memory card] shall specify in detail the reasons on which they are based. A decision shall be communicated to the party concerned, who shall at the same time be informed of the remedies available to him under the laws of the Member States and of the time-limits for the exercise of such remedies.

**Changes to legislation:** There are currently no known outstanding effects for the Council Regulation (EEC) No 3821/85. (See end of Document for details)

#### Textual Amendments

- F3** Inserted by Council Regulation (EC) No 2135/98 of 24 September 1998 amending Regulation (EEC) No 3821/85 on recording equipment in road transport and Directive 88/599/EEC concerning the application of Regulations (EEC) No 3820/85 and (EEC) No 3821/85.

### CHAPTER III

#### Installation and inspection

##### Article 12

1 Recording equipment may be installed or repaired only by fitters or workshops approved by the competent authorities of Member States for that purpose after the latter, should they so desire, have heard the views of the manufacturers concerned.

[<sup>F3</sup>The period of administrative validity of approved workshop and fitter cards shall not exceed one year.

If a card issued to an approved workshop or fitter is to be extended, is damaged, malfunctions, is lost or is stolen, the authority shall supply a replacement card within five working days of receiving a detailed request to that effect.

Where a new card is issued to replace an old one, the new card shall bear the same 'workshop' information number, but the index shall be increased by one. The authority issuing the card shall maintain a register of lost, stolen or defective cards.

Member States shall take any measure necessary to prevent the cards distributed to approved fitters and workshops from being falsified.]

[<sup>F12</sup> The approved fitter or workshop shall place a special mark on the seals which it affixes and, in addition, shall enter for recording equipment in conformity with Annex IB, the electronic security data for carrying out, in particular, the authentication checks. The competent authorities of each Member State shall maintain a register of the marks and electronic security data used and of approved workshop and fitter cards issued.]

[<sup>F13</sup> The competent authorities of the Member States shall forward to the Commission the lists of approved fitters and workshops and the cards issued to them and shall forward to it copies of the marks and of the necessary information relating to the electronic security data used.]

4 For the purpose of certifying that installation of recording equipment took place in accordance with the requirements of this Regulation an installation plaque affixed as provided in [<sup>F1</sup>Annexes I and IB] shall be used.

[<sup>F55</sup> Any seal may be removed by the fitters or workshops approved by competent authorities under paragraph 1 of this Article, or in the circumstances described in Annex I, Chapter V, paragraph 4 [<sup>F3</sup>or in Annex IB section VI(c)] to this Regulation.]

#### Textual Amendments

- F1** Substituted by Council Regulation (EC) No 2135/98 of 24 September 1998 amending Regulation (EEC) No 3821/85 on recording equipment in road transport and Directive 88/599/EEC concerning the application of Regulations (EEC) No 3820/85 and (EEC) No 3821/85.

---

**Changes to legislation:** There are currently no known outstanding effects for the Council Regulation (EEC) No 3821/85. (See end of Document for details)

---

- F3** Inserted by Council Regulation (EC) No 2135/98 of 24 September 1998 amending Regulation (EEC) No 3821/85 on recording equipment in road transport and Directive 88/599/EEC concerning the application of Regulations (EEC) No 3820/85 and (EEC) No 3821/85.
- F5** Inserted by Commission Regulation (EEC) No 3688/92 of 21 December 1992 adapting to technical progress Council Regulation (EEC) No 3821/85 on recording equipment in road transport.

## CHAPTER IV

### Use of equipment

#### *[<sup>F1</sup>Article 13*

The employer and drivers shall ensure the correct functioning and proper use of, on the one hand, the recording equipment and, on the other, the driver card where a driver is required to drive a vehicle fitted with recording equipment in conformity with Annex IB.]

#### **Textual Amendments**

- F1** Substituted by Council Regulation (EC) No 2135/98 of 24 September 1998 amending Regulation (EEC) No 3821/85 on recording equipment in road transport and Directive 88/599/EEC concerning the application of Regulations (EEC) No 3820/85 and (EEC) No 3821/85.

#### *Article 14*

[<sup>F11</sup> The employer shall issue a sufficient number of record sheets to drivers of vehicles fitted with recording equipment in conformity with Annex I, bearing in mind the fact that these sheets are personal in character, the length of the period of service and the possible obligation to replace sheets which are damaged, or have been taken by an authorised inspecting officer. The employer shall issue to drivers only sheets of an approved model suitable for use in the equipment installed in the vehicle.

Where the vehicle is fitted with recording equipment in conformity with Annex IB, the employer and the driver shall ensure that, taking into account the length of the period of service, the printing on request referred to in Annex IB can be carried out correctly in the event of an inspection.]

[<sup>F22</sup> The undertaking shall keep record sheets and printouts, whenever printouts have been made to comply with Article 15(1), in chronological order and in a legible form for at least a year after their use and shall give copies to the drivers concerned who request them. The undertaking shall also give copies of downloaded data from the driver cards to the drivers concerned who request them and the printed papers of these copies. The record sheets, printouts and downloaded data shall be produced or handed over at the request of any authorised inspecting officer.]

[<sup>F33</sup> The driver card as defined in Annex IB shall be issued, at the request of the driver, by the competent authority of the Member State where the driver has his normal residence.

A Member State may require any driver subject to the provisions of Regulation (EEC) No 3820/85 and normally resident on its territory to hold a driver card.

- a For the purposes of this Regulation ‘normal residence’ means the place where a person usually lives, that is for at least 185 days in each calendar year, because of personal and occupational ties, or, in the case of a person with no occupational ties, because of

---

*Changes to legislation: There are currently no known outstanding effects for the Council Regulation (EEC) No 3821/85. (See end of Document for details)*

---

personal ties which show close links between that person and the place where he is living.

However, the normal residence of a person whose occupational ties are in a different place from his personal ties and who consequently lives in turn in different places situated in two or more Member States shall be regarded as being the place of his personal ties, provided that such person returns there regularly. This last condition need not be met where the person is living in a Member State in order to carry out a fixed-term assignment.

- b Drivers shall give proof of their place of normal residence by any appropriate means, such as their identity card or any other valid document.
- c Where the competent authorities of the Member State issuing the driver card have doubts as to the validity of a statement as to normal residence made in accordance with point (b), or for the purpose of certain specific controls, they may request any additional information or evidence.
- d The competent authorities of the issuing Member State shall, as far as this can be done, ensure that the applicant does not already hold a valid driver card.

4

- a The competent authority of the Member State shall personalise the driver card in accordance with the provisions of Annex IB.

For administrative purposes, the driver card may not be valid for more than five years.

The driver may hold one valid driver card only. The driver is authorised to use only his own personalised driver card. The driver shall not use a driver card which is defective or which has expired.

When a new driver card is issued replacing the old, the new card shall bear the same driver card issue number but the index shall be increased by one. The issuing authority shall keep records of issued, stolen, lost or defective driver cards for a period at least equivalent to their period of administrative validity.

If the driver card is damaged, malfunctions or is lost or stolen, the authority shall supply a replacement card within five working days of receiving a detailed request to that effect.

In the event of a request for the renewal of a card whose expiry date is approaching, the authority shall supply a new card before the expiry date provided that the request was sent to it within the time limits laid down in the second subparagraph of Article 15(1).

- b Driver cards shall be issued only to applicants who are subject to the provisions of Regulation (EEC) No 3820/85.
- c The driver card shall be personal. It may not, during its official period of validity, be withdrawn or suspended for whatever reason unless the competent authority of a Member State finds that the card has been falsified, or the driver is using a card of which he is not the holder, or that the card held has been obtained on the basis of false declarations and/or forged documents. If such suspension or withdrawal measures are taken by a Member State other than the Member State of issue, the former shall return the card to the authorities of the Member State which issued it and shall indicate the reasons for returning it.
- d Driver cards issued by Member States shall be mutually recognised.

Where the holder of a valid driver card issued by a Member State has established his normal place of residence in another Member State, he may ask for his card to be exchanged for an equivalent driver card; it shall be the responsibility of the Member

---

*Changes to legislation: There are currently no known outstanding effects for the Council Regulation (EEC) No 3821/85. (See end of Document for details)*

---

State which carries out the exchange to verify if necessary whether the card produced is actually still valid.

Member States carrying out an exchange shall return the old card to the authorities of the Member State of issue and indicate the reasons for so doing.

- e Where a Member State replaces or exchanges a driver card, the replacement or exchange, and any subsequent replacement or renewal, shall be registered in that Member State.
- f Member States shall take all the necessary measures to prevent any possibility of driver cards being falsified.

5 Member States shall ensure that data needed to monitor compliance with Regulation (EEC) No 3820/85 and Council Directive 92/6/EEC of 10 February 1992 on the installation and use of speed limitation devices for certain categories of motor vehicles in the Community<sup>(8)</sup> which are recorded and stored by recording equipment in conformity with Annex IB to this Regulation can be made available for at least 365 days after the date of their recording and that they can be made available under conditions that guarantee the security and accuracy of the data.

Member States shall take any measures necessary to ensure that the resale or decommissioning of recording equipment cannot detract, in particular, from the satisfactory application of this paragraph.]

#### Textual Amendments

- F1** Substituted by Council Regulation (EC) No 2135/98 of 24 September 1998 amending Regulation (EEC) No 3821/85 on recording equipment in road transport and Directive 88/599/EEC concerning the application of Regulations (EEC) No 3820/85 and (EEC) No 3821/85.
- F2** Substituted by Regulation (EC) No 561/2006 of the European Parliament and of the Council of 15 March 2006 on the harmonisation of certain social legislation relating to road transport and amending Council Regulations (EEC) No 3821/85 and (EC) No 2135/98 and repealing Council Regulation (EEC) No 3820/85 (Text with EEA relevance).
- F3** Inserted by Council Regulation (EC) No 2135/98 of 24 September 1998 amending Regulation (EEC) No 3821/85 on recording equipment in road transport and Directive 88/599/EEC concerning the application of Regulations (EEC) No 3820/85 and (EEC) No 3821/85.

#### Article 15

1 Drivers shall not use dirty or damaged record sheets [<sup>F3</sup>or driver cards]. The sheets [<sup>F3</sup>or driver cards] shall be adequately protected on this account.

[<sup>F3</sup>Where a driver wishes to renew his driver card, he shall apply to the competent authorities of the Member State in which he has his normal residence not later than 15 working days before the expiry date of the card.]

In case of damage to a sheet bearing recordings [<sup>F3</sup>or driver card], drivers shall attach the damaged sheet [<sup>F3</sup>or driver card] to the spare sheet used to replace it.

[<sup>F3</sup>If the driver card is damaged, malfunctions or is lost or stolen, the driver shall apply within seven calendar days for its replacement to the competent authorities of the Member State in which he has his normal residence.]

[<sup>F6</sup>Where a driver card is damaged, malfunctions, or is not in the possession of the driver, the driver shall:

---

*Changes to legislation: There are currently no known outstanding effects for the Council Regulation (EEC) No 3821/85. (See end of Document for details)*

---

- a at the start of his journey, print out the details of the vehicle the driver is driving, and shall enter onto that printout:
    - (i) details that enable the driver to be identified (name, driver card or driver's licence number), including his signature;
    - (ii) the periods referred to in paragraph 3, second indent (b), (c) and (d);
  - b at the end of his journey, print out the information relating to periods of time recorded by the recording equipment, record any periods of other work, availability and rest undertaken since the printout that was made at the start of the journey, where not recorded by the tachograph, and mark on that document details that enable the driver to be identified (name, driver card or driver's licence number), including the driver's signature.]
- 2 Drivers shall use the record sheets [<sup>F3</sup>or driver cards] every day on which they are driving, starting from the moment they take over the vehicle. The record sheet [<sup>F3</sup>or driver card] shall not be withdrawn before the end of the daily working period unless its withdrawal is otherwise authorized. No record sheet [<sup>F3</sup>or driver card] may be used to cover a period longer than that for which it is intended.

[<sup>F2</sup>When as a result of being away from the vehicle, a driver is unable to use the equipment fitted to the vehicle, the periods of time referred to in paragraph 3, second indent (b), (c) and (d) shall:

- a if the vehicle is fitted with recording equipment in conformity with Annex I, be entered on the record sheet, either manually, by automatic recording or other means, legibly and without dirtying the sheet; or
- b if the vehicle is fitted with recording equipment in conformity with Annex IB, be entered onto the driver card using the manual entry facility provided in the recording equipment.

Where there is more than one driver on board the vehicle fitted with recording equipment in conformity with Annex IB, each driver shall ensure that his driver card is inserted into the correct slot in the tachograph.]

Drivers shall amend the record sheets as necessary should there be more than one driver on board the vehicle, so that the information referred to in Chapter II (1) to (3) of Annex I is recorded on the record sheet of the driver who is actually driving.

- 3 Drivers shall:
- ensure that the time recorded on the sheet agrees with the official time in the country of registration of the vehicle,
  - operate the switch mechanisms enabling the following periods of time to be recorded separately and distinctly:
    - (a) under the sign  : driving time;
    - (b) '[<sup>F2</sup>other work' means any activity other than driving, as defined in Article 3(a) of Directive 2002/15/EC of the European Parliament and of the Council of 11 March 2002 on the organisation of the working time of persons performing mobile road transport activities<sup>(9)</sup>, and also any work for the same or another employer within or outside of the transport sector, and must be recorded under this sign

---

*Changes to legislation: There are currently no known outstanding effects for the Council Regulation (EEC) No 3821/85. (See end of Document for details)*

---



(c) 'availability' defined in Article 3(b) of Directive 2002/15/EC must be recorded under this sign ;

(d) under the sign  : breaks in work and daily rest periods.

F<sup>7</sup>4

- 5 Each crew member shall enter the following information on his record sheet:
- a on beginning to use the sheet — his surname and first name;
  - b the date and place where use of the sheet begins and the date and place where such use ends;
  - c the registration number of each vehicle to which he is assigned, both at the start of the first journey recorded on the sheet and then, in the event of a change of vehicle, during use of the sheet;
  - d the odometer reading:
    - at the start of the first journey recorded on the sheet,
    - at the end of the last journey recorded on the sheet,
    - in the event of a change of vehicle during a working day (reading on the vehicle to which he was assigned and reading on the vehicle to which he is to be assigned);
  - e the time of any change of vehicle.

[<sup>F3</sup>5a The driver shall enter in the recording equipment in conformity with Annex IB the symbols of the countries in which he begins and ends his daily work period. However, a Member State may require drivers of vehicles engaged in transport operations inside its territory to add more detailed geographic specifications to the country symbol provided that the Member State has notified them to the Commission before 1 April 1998 and that they do not number more than 20.

The above data entries shall be activated by the driver, and may be entirely manual or automatic if the recording equipment is linked to a satellite tracking system.]

6 The [<sup>F1</sup>recording equipment defined in Annex I] shall be so designed that it is possible for an authorized inspecting officer, if necessary after opening the equipment, to read the recordings relating to the nine hours preceding the time of the check without permanently deforming, damaging or soiling the sheet.

The equipment shall, furthermore, be so designed that it is possible, without opening the case, to verify that recordings are being made.

[<sup>F2</sup>7

- a Where the driver drives a vehicle fitted with recording equipment in conformity with Annex I, the driver must be able to produce, whenever an inspecting officer so requests:
  - (i) the record sheets for the current week and those used by the driver in the previous 15 days;
  - (ii) the driver card if he holds one, and



---

*Changes to legislation: There are currently no known outstanding effects for the Council Regulation (EEC) No 3821/85. (See end of Document for details)*

---

- (iii) any manual record and printout made during the current week and the previous 15 days as required under this Regulation and Regulation (EC) No 561/2006.

However, after 1 January 2008, the time periods referred to under (i) and (iii) shall cover the current day and the previous 28 days.

- b Where the driver drives a vehicle fitted with recording equipment in conformity with Annex IB, the driver must be able to produce, whenever an inspecting officer so requests:

- (i) the driver card of which he is holder;
- (ii) any manual record and printout made during the current week and the previous 15 days as required under this Regulation and Regulation (EC) No 561/2006, and
- (iii) the record sheets corresponding to the same period as the one referred to in the previous subparagraph during which he drove a vehicle fitted with recording equipment in conformity with Annex I.

However, after 1 January 2008, the time periods referred to under (ii) shall cover the current day and the previous 28 days.

- c An authorised inspecting officer may check compliance with Regulation (EC) No 561/2006 by analysis of the record sheets, of the displayed or printed data which have been recorded by the recording equipment or by the driver card or, failing this, by analysis of any other supporting document that justifies non-compliance with a provision, such as those laid down in Article 16(2) and (3).]

[<sup>F38</sup> It shall be forbidden to falsify, suppress or destroy data recorded on the record sheet, stored in the recording equipment or on the driver card, or print-outs from the recording equipment as defined in Annex IB. The same applies to any manipulation of the recording equipment, record sheet or driver card which may result in data and/or printed information being falsified, suppressed or destroyed. No device which could be used to this effect shall be present on the vehicle.]

#### **Textual Amendments**

- F1** Substituted by Council Regulation (EC) No 2135/98 of 24 September 1998 amending Regulation (EEC) No 3821/85 on recording equipment in road transport and Directive 88/599/EEC concerning the application of Regulations (EEC) No 3820/85 and (EEC) No 3821/85.
- F2** Substituted by Regulation (EC) No 561/2006 of the European Parliament and of the Council of 15 March 2006 on the harmonisation of certain social legislation relating to road transport and amending Council Regulations (EEC) No 3821/85 and (EC) No 2135/98 and repealing Council Regulation (EEC) No 3820/85 (Text with EEA relevance).
- F3** Inserted by Council Regulation (EC) No 2135/98 of 24 September 1998 amending Regulation (EEC) No 3821/85 on recording equipment in road transport and Directive 88/599/EEC concerning the application of Regulations (EEC) No 3820/85 and (EEC) No 3821/85.
- F6** Inserted by Regulation (EC) No 561/2006 of the European Parliament and of the Council of 15 March 2006 on the harmonisation of certain social legislation relating to road transport and amending Council Regulations (EEC) No 3821/85 and (EC) No 2135/98 and repealing Council Regulation (EEC) No 3820/85 (Text with EEA relevance).
- F7** Deleted by Regulation (EC) No 561/2006 of the European Parliament and of the Council of 15 March 2006 on the harmonisation of certain social legislation relating to road transport and amending Council

---

**Changes to legislation:** There are currently no known outstanding effects for the Council Regulation (EEC) No 3821/85. (See end of Document for details)

---

Regulations (EEC) No 3821/85 and (EC) No 2135/98 and repealing Council Regulation (EEC) No 3820/85 (Text with EEA relevance).

### Article 16

1 In the event of breakdown or faulty operation of the equipment, the employer shall have it repaired by an approved fitter or workshop, as soon as circumstances permit.

If the vehicle is unable to return to the premises within a period of one week calculated from the day of the breakdown or of the discovery of defective operation, the repair shall be carried out *en route*.

Measures taken by Member States pursuant to Article 19 may give the competent authorities power to prohibit the use of the vehicle in cases where breakdown or faulty operation has not been put right as provided in the foregoing subparagraphs.

[<sup>F12</sup> While the recording equipment is unserviceable or malfunctioning, drivers shall mark on the record sheet or sheets, or on a temporary sheet to be attached to the record sheet or to the driver card, on which he shall enter data enabling him to be identified (driver's card number and/or name and/or driving licence number), including his signature, all information for the various periods of time which are no longer recorded or printed out correctly by the recording equipment.

If a driver card is damaged, malfunctions or is lost or stolen, the driver shall, at the end of his journey, print out the information relating to the periods of time recorded by the recording equipment and mark on that document the details that enable him to be identified (the driver card number and/or name and/or driving licence number), including his signature.]

[<sup>F33</sup> If a driver card is damaged or if it malfunctions, the driver shall return it to the competent authority of the Member State in which he has his normal residence. Theft of the driver card shall be the subject of a formal declaration to the competent authorities of the State where the theft occurred.

Loss of the driver card must be reported in a formal declaration to the competent authorities of the State that issued it and to the competent authorities of the Member State of normal residence where they are different.

The diver may continue to drive without a driver card for a maximum period of 15 calendar days or for a longer period if this is necessary for the vehicle to return to its premises, provided he can prove the impossibility of producing or using the card during this period.

Where the authorities of the Member State in which the driver has his normal residence are different from those which issued his card and where the latter are requested to renew, replace or exchange the driver card, they shall inform the authorities which issued the old card of the precise reasons for its renewal, replacement or exchange.]

#### Textual Amendments

- F1** Substituted by Council Regulation (EC) No 2135/98 of 24 September 1998 amending Regulation (EEC) No 3821/85 on recording equipment in road transport and Directive 88/599/EEC concerning the application of Regulations (EEC) No 3820/85 and (EEC) No 3821/85.

---

**Changes to legislation:** There are currently no known outstanding effects for the Council Regulation (EEC) No 3821/85. (See end of Document for details)

---

**F3** Inserted by Council Regulation (EC) No 2135/98 of 24 September 1998 amending Regulation (EEC) No 3821/85 on recording equipment in road transport and Directive 88/599/EEC concerning the application of Regulations (EEC) No 3820/85 and (EEC) No 3821/85.

## CHAPTER V

### Final provisions

#### *[F<sup>1</sup> Article 17*

[<sup>F4</sup>1 The amendments required to adjust the annexes to technical progress, designed to amend non-essential elements of this Regulation, shall be adopted in accordance with the regulatory procedure with scrutiny referred to in Article 18(2).]

2 The technical specifications relating to the following sections of Annex IB shall be adopted as soon as possible and if possible before 1 July 1998 by the same procedure:

- a Chapter II
  - (d) 17: displaying and printing of faults in the recording equipment,
  - (d) 18: displaying and printing of faults in the driver card,
  - (d) 21: displaying and printing of summary reports;
- b Chapter III
  - (a) 6.3: standards for the protection of vehicle electronics against electrical interference and magnetic fields,
  - (a) 6.5: protection (security) of the total system,
  - (c) 1: warning signals indicating the internal malfunctioning of the recording equipment,
  - (c) 5: format of the warnings,
  - (f): maximum tolerances;
- c Chapter IV, A:
  - 4: standards,
  - 5: security, including data protection,
  - 6: temperature range,
  - 8: electrical characteristics,
  - 9: logical structure of the driver card,

---

*Changes to legislation:* There are currently no known outstanding effects for the Council Regulation (EEC) No 3821/85. (See end of Document for details)

---

- 10: functions and commands,
  - 11: elementary files;
- and Chapter IV, B;
- d Chapter V:  
printer and standard print-outs.]

#### Textual Amendments

- F1** Substituted by [Council Regulation \(EC\) No 2135/98 of 24 September 1998 amending Regulation \(EEC\) No 3821/85 on recording equipment in road transport and Directive 88/599/EEC concerning the application of Regulations \(EEC\) No 3820/85 and \(EEC\) No 3821/85.](#)
- F4** Substituted by [Regulation \(EC\) No 219/2009 of the European Parliament and of the Council of 11 March 2009 adapting a number of instruments subject to the procedure referred to in Article 251 of the Treaty to Council Decision 1999/468/EC with regard to the regulatory procedure with scrutiny Adaptation to the regulatory procedure with scrutiny — Part Two.](#)

#### *[<sup>F4</sup>Article 18*

- 1 The Commission shall be assisted by a Committee.
- 2 Where reference is made to this paragraph, Article 5a(1) to (4) and Article 7 of Decision 1999/468/EC shall apply, having regard to the provisions of Article 8 thereof.]

#### Textual Amendments

- F4** Substituted by [Regulation \(EC\) No 219/2009 of the European Parliament and of the Council of 11 March 2009 adapting a number of instruments subject to the procedure referred to in Article 251 of the Treaty to Council Decision 1999/468/EC with regard to the regulatory procedure with scrutiny Adaptation to the regulatory procedure with scrutiny — Part Two.](#)

#### *Article 19*

1 Member States shall, in good time and after consulting the Commission, adopt such laws, regulations or administrative provisions as may be necessary for the implementation of this Regulation.

Such measures shall cover, *inter alia*, the reorganization of, procedure for, and means of carrying out, checks on compliance and the penalties to be imposed in case of breach.

2 Member States shall assist each other in applying this Regulation and in checking compliance therewith.

3 Within the framework of this mutual assistance the competent authorities of the Member States shall regularly send one another all available information concerning:

- breaches of this Regulation committed by non-residents and any penalties imposed for such breaches,
- penalties imposed by a Member State on its residents for such breaches committed in other Member States.

---

**Changes to legislation:** There are currently no known outstanding effects for the Council Regulation (EEC) No 3821/85. (See end of Document for details)

---

#### *Article 20*

Regulation (EEC) No 1463/70 shall be repealed.

However, Article 3 (1) of the said Regulation shall, until 31 December 1989, continue to apply to vehicles and drivers employed in regular international passenger services in so far as the vehicles used for such services are not fitted with recording equipment used as prescribed in this Regulation.

#### *F<sup>8</sup> Article 20a*

This Regulation shall not apply until 1 January 1991 to vehicles registered in the territory of the former German Democratic Republic before that date.

This Regulation shall not apply until 1 January 1993 to such vehicles where they are engaged only in national transport operations in the territory of the Federal Republic of Germany. However, this Regulation shall apply as from its entry into force to vehicles engaged in the carriage of dangerous goods.]

#### **Textual Amendments**

- F8** Inserted by [Council Regulation \(EEC\) No 3572/90 of 4 December 1990 amending, as a result of German unification, certain Directives, Decisions and Regulations relating to transport by road, rail and inland waterway.](#)

#### *Article 21*

This Regulation shall enter into force on 29 September 1986.

This Regulation shall be binding in its entirety and directly applicable in all Member States.

---

*Changes to legislation: There are currently no known outstanding effects for the Council Regulation (EEC) No 3821/85. (See end of Document for details)*

---

## ANNEX I

### REQUIREMENTS FOR CONSTRUCTION, TESTING, INSTALLATION AND INSPECTION

#### I. DEFINITIONS

In this Annex:

(a) **Recording equipment means:**

equipment intended for installation in road vehicles to show and record automatically or semi-automatically details of the movement of those vehicles and of certain working periods of their drivers;

(b) **Record sheet means:**

a sheet designed to accept and retain recorded data, to be placed in the recording equipment and on which the marking devices of the latter inscribe a continuous record of the information to be recorded;

(c) **The constant of the recording equipment means:**

the numerical characteristic giving the value of the input signal required to show and record a distance travelled of one kilometre; this constant must be expressed either in revolutions per kilometre ( $k = \dots \text{ rev/km}$ ), or in impulses per kilometre ( $k = \dots \text{ imp/km}$ );

(d) **Characteristic coefficient of the means:**

the numerical characteristic giving the value of the output signal emitted by the part of the vehicle linking it with the recording equipment (gearbox output shaft or axle) while the vehicle travels a distance of one measured kilometre under normal test conditions (see Chapter VI, point 4 of this Annex). The characteristic coefficient is expressed either in revolutions per kilometre ( $w = \dots \text{ rev/km}$ ) or in impulses per kilometre ( $w = \dots \text{ imp/km}$ );

(e) **Effective circumference of wheel tyres means:**

the average of the distances travelled by the several wheels moving the vehicle (driving wheels) in the course of one complete rotation. The measurement of these distances must be made under normal test conditions (see Chapter VI, point 4 of this Annex) and is expressed in the form:  $l = \dots \text{ mm}$ .

#### II. GENERAL CHARACTERISTICS AND FUNCTIONS OF RECORDING EQUIPMENT

The equipment must be able to record the following:

1. distance travelled by the vehicle;
2. speed of the vehicle;
3. driving time;
4. other periods of work or of availability;
5. breaks from work and daily rest periods;
6. opening of the case containing the record sheet [F<sup>9</sup>];

---

**Changes to legislation:** There are currently no known outstanding effects for the Council Regulation (EEC) No 3821/85. (See end of Document for details)

---

7. [F10 for electronic recording equipment which is equipment operating by signals transmitted electrically from the distance and speed sensor, any interruption exceeding 100 milliseconds in the power supply of the recording equipment (except lighting), in the power supply of the distance and speed sensor and any interruption in the signal lead to the distance and speed sensor.]

#### Textual Amendments

- F9** Substituted by [Commission Regulation \(EEC\) No 3314/90 of 16 November 1990 Commission Regulation adapting to technical progress Council Regulation \(EEC\) No 3821/85 on recording equipment in road transport.](#)
- F10** Inserted by [Commission Regulation \(EEC\) No 3314/90 of 16 November 1990 Commission Regulation adapting to technical progress Council Regulation \(EEC\) No 3821/85 on recording equipment in road transport.](#)

For vehicles used by two drivers the equipment must be capable of recording simultaneously but distinctly and on two separate sheets details of the periods listed under 3, 4 and 5.

### III. CONSTRUCTION REQUIREMENTS FOR RECORDING EQUIPMENT

#### (a) General points

##### 1. *Recording equipment shall include the following:*

##### 1.1. Visual instruments showing:

- distance travelled (distance recorder),
- speed (speedometer),
- time (clock).

##### 1.2. Recording instruments comprising:

- a recorder of the distance travelled,
- a speed recorder,
- one or more time recorders satisfying the requirements laid down in Chapter III (c) 4.

##### [F9]1.3. A means of marking showing on the record sheet individually:

- each opening of the case containing that sheet,
- for electronic recording equipment, as defined in point 7 of Chapter II, any interruption exceeding 100 milliseconds in the power supply of the recording equipment (except lighting), not later than at switching-on the power supply again,
- for electronic recording equipment, as defined in point 7 of Chapter II, any interruption exceeding 100 milliseconds in the power supply of the distance and speed sensor and any interruption in the signal lead to the distance and speed sensor.]

2. Any inclusion in the equipment of devices additional to those listed above must not interfere with the proper operation of the mandatory devices or with the reading of them.

The equipment must be submitted for approval complete with any such additional devices.

#### 3. Materials

- 3.1. All the constituent parts of the recording equipment must be made of materials with sufficient stability and mechanical strength and stable electrical and magnetic characteristics.

---

*Changes to legislation: There are currently no known outstanding effects for the Council Regulation (EEC) No 3821/85. (See end of Document for details)*

---

3.2. Any modification in a constituent part of the equipment or in the nature of the materials used for its manufacture must, before being applied in manufacture, be submitted for approval to the authority which granted type-approval for the equipment.

4. Measurement of distance travelled

The distances travelled may be measured and recorded either:

- so as to include both forward and reverse movement, or
- so as to include only forward movement.

Any recording of reversing movements must on no account affect the clarity and accuracy of the other recordings.

5. Measurement of speed

- 5.1. The range of speed measurement shall be as stated in the type approval certificate.
- 5.2. The natural frequency and the damping of the measuring device must be such that the instruments showing and recording the speed can, within the range of measurement, follow acceleration changes of up to  $2 \text{ m/s}^2$ , within the limits of accepted tolerances.

6. Measurement of time (clock)

- 6.1. The control of the mechanism for resetting the clock must be located inside a case containing the record sheet; each opening of that case must be automatically recorded on the record sheet.
- 6.2. If the forward movement mechanism of the record sheet is controlled by the clock, the period during which the latter will run correctly after being fully wound must be greater by at least 10 % than the recording period corresponding to the maximum sheet-load of the equipment.

7. Lighting and Protection

- 7.1. The visual instruments of the equipment must be provided with adequate non-dazzling lighting.
- 7.2. For normal conditions of use, all the internal parts of the equipment must be protected against damp and dust. In addition they must be made proof against tampering by means of casings capable of being sealed.

(b) Visual instruments

1. Distance travelled indicator (distance recorder)

- 1.1. The value of the smallest grading on the instrument showing distance travelled must be 0,1 kilometres. Figures showing hectometres must be clearly distinguishable from those showing whole kilometres.
- 1.2. The figures on the distance recorder must be clearly legible and must have an apparent height of at least 4 mm.
- 1.3. The distance recorder must be capable of reading up to at least 99 999,9 kilometres.

2. Speed indicators (speedometer)



---

*Changes to legislation: There are currently no known outstanding effects for the Council Regulation (EEC) No 3821/85. (See end of Document for details)*

---

- 2.1. Within the range of measurement, the speed scale must be uniformly graduated by 1, 2, 5 or 10 kilometres per hour. The value of a speed graduation (space between two successive marks) must not exceed 10 % of the maximum speed shown on the scale.
- 2.2. The range indicated beyond that measured need not be marked by figures.
- 2.3. The length of each space on the scale representing a speed difference of 10 kilometres per hour must not be less than 10 millimetres.
- 2.4. On an indicator with a needle, the distance between the needle and the instrument face must not exceed three millimetres.
3. Time indicator (clock)

The time indicator must be visible from outside the equipment and give a clear, plain and unambiguous reading.

(c) Recording instruments

1. General points

- 1.1. All equipment, whatever the form of the record sheet (strip or disc) must be provided with a mark enabling the record sheet to be inserted correctly, in such a way as to ensure that the time shown by the clock and the time-marking on the sheet correspond.
- 1.2. The mechanism moving the record sheet must be such as to ensure that the latter moves without play and can be freely inserted and removed.
- 1.3. For record sheets in disc form, the forward movement device must be controlled by the clock mechanism. In this case, the rotating movement of the sheet must be continuous and uniform, with a minimum speed of seven millimetres per hour measured at the inner border of the ring marking the edge of the speed recording area.

In equipment of the strip type, where the forward movement device of the sheets is controlled by the clock mechanism the speed of rectilinear forward movement must be at least 10 millimetres per hour.

- 1.4. Recording of the distance travelled, of the speed of the vehicle and of any opening of the case containing the record sheet or sheets must be automatic.
2. Recording distance travelled
  - 2.1. Every kilometre of distance travelled must be represented on the record by a variation of at least one millimetre on the corresponding coordinate.
  - 2.2. Even at speeds reaching the upper limit of the range of measurement, the record of distances must still be clearly legible.
3. Recording speed
  - 3.1. Whatever the form of the record sheet, the speed recording stylus must normally move in a straight line and at right angles to the direction of travel of the record sheet.

However, the movement of the stylus may be curvilinear, provided the following conditions are satisfied:

- the trace drawn by the stylus must be perpendicular to the average circumference (in the case of sheets in disc form) or to the axis (in the case of sheets in strip form) of the area reserved for speed recording,

---

*Changes to legislation: There are currently no known outstanding effects for the Council Regulation (EEC) No 3821/85. (See end of Document for details)*

---

- the ratio between the radius of curvature of the trace drawn by the stylus and the width of the area reserved for speed recording must be not less than 2,4 to 1 whatever the form of the record sheet,
- the markings on the time-scale must cross the recording area in a curve of the same radius as the trace drawn by the stylus. The spaces between the markings on the time-scale must represent a period not exceeding one hour.

3.2. Each variation in speed of 10 kilometres per hour must be represented on the record by a variation of at least 1,5 millimetres on the corresponding coordinate.

#### 4. Recording time

[<sup>F9</sup>4.1. Recording equipment must be so constructed that the period of driving time is always recorded automatically and that it is possible, through the operation where necessary of a switch device to record separately the other periods of time as indicated in Article 15 (3), second indent (b), (c) and (d) of the Regulation.]

4.2. It must be possible, from the characteristics of the traces, their relative positions and if necessary the signs laid down in Article 15 of the Regulation to distinguish clearly between the various periods of time.

The various periods of time should be differentiated from one another on the record by differences in the thickness of the relevant traces, or by any other system of at least equal effectiveness from the point of view of legibility and ease of interpretation of the record.

4.3. In the case of vehicles with a crew consisting of more than one driver, the recordings provided for in point 4.1 must be made on two separate sheets, each sheet being allocated to one driver. In this case, the forward movement of the separate sheets must be effected either by a single mechanism or by separate synchronized mechanisms.

#### (d) Closing device

1. The case containing the record sheet or sheets and the control of the mechanism for resetting the clock must be provided with a lock.
2. Each opening of the case containing the record sheet or sheets and the control of the mechanism for resetting the clock must be automatically recorded on the sheet or sheets.

#### (e) Markings

1. The following markings must appear on the instrument face of the equipment:
  - close to the figure shown by the distance recorder, the unit of measurement of distance, indicated by the abbreviation 'km',
  - near the speed scale, the marking 'km/h',
  - the measurement range of the speedometer in the form 'Vmin ... km/h, Vmax ... km/h', This marking is not necessary if it is shown on the descriptive plaque of the equipment.

However, these requirements shall not apply to recording equipment approved before 10 August 1970.

2. The descriptive plaque must be built into the equipment and must show the following markings, which must be visible on the equipment when installed:
  - name and address of the manufacturer of the equipment,
  - manufacturer's number and year of construction,

---

**Changes to legislation:** There are currently no known outstanding effects for the Council Regulation (EEC) No 3821/85. (See end of Document for details)

---

- approval mark for the equipment type,
- the constant of the equipment in the form 'k = ... rev/km' or 'k = ... imp/km',
- optionally, the range of speed measurement, in the form indicated in point 1,
- should the sensitivity of the instrument to the angle of inclination be capable of affecting the readings given by the equipment beyond the permitted tolerances, the permissible angle expressed as:

where  $\alpha$  is the angle measured from the horizontal position of the front face (fitted the right way up) of the equipment for which the instrument is calibrated, while  $\beta$  and  $\gamma$  represent respectively the maximum permissible upward and downward deviations from the angle of calibration  $\alpha$ .

- (f) Maximum tolerances (visual and recording instruments)
1. On the test bench before installation:
    - (a) distance travelled:  
1 % more or less than the real distance, where that distance is at least one kilometre;
    - (b) speed:  
3 km/h more or less than the real speed;
    - (c) time:  
 $\pm$  two minutes per day with a maximum of 10 minutes per seven days in cases where the running period of the clock after rewinding is not less than that period.
  2. On installation:
    - (a) distance travelled:  
2 % more or less than the real distance, where that distance is at least one kilometre;
    - (b) speed:  
4 km/h more or less than the real speed;
    - (c) time:  
 $\pm$  two minutes per day, or  
 $\pm$  10 minutes per seven days.
  3. In use:
    - (a) distance travelled:  
4 % more or less than the real distance, where that distance is at least one kilometre;
    - (b) speed:  
6 km/h more or less than the real speed;
    - (c) time:  
 $\pm$  two minutes per day, or  
 $\pm$  10 minutes per seven days.

---

*Changes to legislation: There are currently no known outstanding effects for the Council Regulation (EEC) No 3821/85. (See end of Document for details)*

---

4. The maximum tolerances set out in points 1, 2 and 3 are valid for temperatures between 0° and 40 °C, temperatures being taken in close proximity to the equipment.
5. Measurement of the maximum tolerances set out in points 2 and 3 shall take place under the conditions laid down in Chapter VI.

#### IV. RECORD SHEETS

##### (a) General points

1. The record sheets must be such that they do not impede the normal functioning of the instrument and that the records which they contain are indelible and easily legible and identifiable.

The record sheets must retain their dimensions and any records made on them under normal conditions of humidity and temperature.

In addition it must be possible to write on the sheets, without damaging them and without affecting the legibility of the recordings, the information referred to in Article 15 (5) of the Regulation.

Under normal conditions of storage, the recordings must remain clearly legible for at least one year.

2. The minimum recording capacity of the sheets, whatever their form, must be 24 hours.

If several discs are linked together to increase the continuous recording capacity which can be achieved without intervention by staff, the links between the various discs must be made in such a way that there are no breaks in or overlapping of recordings at the point of transfer from one disc to another.

##### (b) Recording areas and their graduation

1. The record sheets shall include the following recording areas:
  - an area exclusively reserved for data relating to speed,
  - an area exclusively reserved for data relating to distance travelled,
  - one or more areas for data relating to driving time, to other periods of work and availability to breaks from work and to rest periods for drivers.
2. The area for recording speed must be scaled off in divisions of 20 kilometres per hour or less. The speed corresponding to each marking on the scale must be shown in figures against that marking. The symbol 'km/h' must be shown at least once within the area. The last marking on the scale must coincide with the upper limit of the range of measurement.
3. The area for recording distance travelled must be set out in such a way that the number of kilometres travelled may be read without difficulty.
4. The area or areas reserved for recording the periods referred to in point 1 must be so marked that it is possible to distinguish clearly between the various periods of time.

##### (c) Information to be printed on the record sheets

Each sheet must bear, in printed form, the following information:

- name and address or trade name of the manufacturer,
- approval mark for the model of the sheet,

---

*Changes to legislation: There are currently no known outstanding effects for the Council Regulation (EEC) No 3821/85. (See end of Document for details)*

---

- approval mark for the type or types of equipment in which the sheet may be used,
- upper limit of the speed measurement range, printed in kilometres per hour.

By way of minimal additional requirements, each sheet must bear, in printed form a time-scale graduated in such a way that the time may be read directly at intervals of fifteen minutes while each five minute interval may be determined without difficulty.

(d) Free space for hand written insertions

A free space must be provided on the sheets such that drivers may as a minimum write in the following details:

- surname and first name of the driver,
- date and place where use of the sheet begins and date and place where such use ends,
- the registration number or numbers of the vehicle or vehicles to which the driver is assigned during the use of the sheet,
- odometer readings from the vehicle or vehicles to which the driver is assigned during the use of the sheet,
- the time at which any change of vehicle takes place.

V. INSTALLATION OF RECORDING EQUIPMENT

1. Recording equipment must be positioned in the vehicle in such a way that the driver has a clear view from his seat of speedometer, distance recorder and clock while at the same time all parts of those instruments, including driving parts, are protected against accidental damage.
2. It must be possible to adapt the constant of the recording equipment to the characteristic coefficient of the vehicle by means of a suitable device, to be known as an adaptor.

Vehicles with two or more rear axle ratios must be fitted with a switch device whereby these various ratios may be automatically brought into line with the ratio for which the equipment has been adapted to the vehicle.

3. After the equipment has been checked on installation, an installation plaque shall be affixed to the vehicle beside the equipment or in the equipment itself and in such a way as to be clearly visible. After every inspection by an approved fitter or workshop requiring a change in the setting of the installation itself, a new plaque must be affixed in place of the previous one.

The plaque must show at least the following details:

- name, address or trade name of the approved fitter or workshop,
- characteristic coefficient of the vehicle, in the form 'w = ... rev/km' or 'w = ... imp/km',
- effective circumference of the wheel tyres in the form 'l = ... mm',
- the dates on which the characteristic coefficient of the vehicle was determined and the effective measured circumference of the wheel tyres.

4. Sealing

The following parts must be sealed:

- (a) the installation plaque, unless it is attached in such a way that it cannot be removed without the markings thereon being destroyed;

---

*Changes to legislation: There are currently no known outstanding effects for the Council Regulation (EEC) No 3821/85. (See end of Document for details)*

---

- (b) the two ends of the link between the recording equipment proper and the vehicle;
- (c) the adaptor itself and the point of its insertion into the circuit;
- (d) the switch mechanism for vehicles with two or more axle ratios;
- (e) the links joining the adaptor and the switch mechanism to the rest of the equipment;
- (f) the casings required under Chapter III (a) 7.2<sup>[F11];</sup>
- (g) <sup>[F5]</sup>any cover giving access to the means of adapting the constant of the recording equipment to the characteristic coefficient of the vehicle.]

#### Textual Amendments

**F11** Substituted by [Commission Regulation \(EEC\) No 3688/92 of 21 December 1992 adapting to technical progress Council Regulation \(EEC\) No 3821/85 on recording equipment in road transport.](#)

In particular cases, further seals may be required on approval of the equipment type and a note of the positioning of these seals must be made on the approval certificate.

<sup>[F11]</sup>The seals mentioned in (b), (c) and (e) are authorized to be removed:

- in case of emergency,
- to install, to adjust or to repair a speed limitation device or any other device contributing to road safety,

provided that the recording equipment continues to function reliably and correctly and is resealed by an approved fitter or workshop immediately after fitting the speed limitation device or any other device contributing to road safety or within seven days in other cases; for each occasion that these seals are broken a written statement giving the reasons for such action must be prepared and made available to the competent authority.]

<sup>[F125]</sup> The cables connecting the recording equipment to the transmitter must be protected by a continuous plastic-coated rust-protected steel sheath with crimped ends except where an equivalent protection against manipulation is guaranteed by other means (for example by electronic monitoring such as signal encryption) capable of detecting the presence of any device, which is unnecessary for the correct operation of the recording equipment and whose purpose is to prevent the accurate operation of the recording equipment by short circuiting or interruption or by modification of the electronic data from the speed and distance sensor. A joint, comprised of sealed connections, is deemed to be continuous within the meaning of this Regulation.

The aforementioned electronic monitoring may be replaced by an electronic control which ensures that the recording equipment is able to record any movement of the vehicle, independent from the signal of the speed and distance sensor.

<sup>[F13]</sup>For the purpose of the application of the present point, M 1 and N 1 vehicles are those defined in Part A of Annex II to Council Directive 70/156/EEC<sup>(10)</sup>. For those vehicles that are equipped with tachographs in compliance with the Regulation and are not designed to install an armoured cable between the distance and speed sensors and the recording equipment, then an adaptor shall be fitted as close as possible to the distance and speed sensors.

*Changes to legislation: There are currently no known outstanding effects for the Council Regulation (EEC) No 3821/85. (See end of Document for details)*

#### Textual Amendments

- F13** Inserted by [Commission Regulation \(EC\) No 1056/97 of 11 June 1997](#) adapting to technical progress [Council Regulation \(EEC\) No 3821/85 on recording equipment in road transport](#) (Text with EEA relevance).

The armoured cable shall be fitted from the adaptor to the recording equipment.]]

#### Textual Amendments

- F12** Substituted by [Commission Regulation \(EC\) No 2479/95 of 25 October 1995](#) adapting to technical progress [Council Regulation \(EEC\) No 3821/85 on recording equipment in road transport](#) (Text with EEA relevance).

## VI. CHECKS AND INSPECTIONS

The Member States shall nominate the bodies which shall carry out the checks and inspections.

### 1. Certification of new or repaired instruments

Every individual device, whether new or repaired, shall be certified in respect of its correct operation and the accuracy of its readings and recordings, within the limits laid down in Chapter III (f) 1, by means of sealing in accordance with Chapter V (4) (f).

For this purpose the Member States may stipulate an initial verification, consisting of a check on and confirmation of the conformity of a new or repaired device with the type-approved model and/or with the requirements of the Regulation and its Annexes, or may delegate the power to certify to the manufacturers or to their authorized agents.

### 2. Installation

When being fitted to a vehicle, the equipment and the whole installation must comply with the provisions relating to maximum tolerances laid down in Chapter III (f) 2.

The inspection tests shall be carried out by the approved fitter or workshop on his or its responsibility.

### 3. Periodic inspections

- (a) Periodic inspections of the equipment fitted to vehicles shall take place at least every two years and may be carried out in conjunction with roadworthiness tests of vehicles.

These inspections shall include the following checks:

- that the equipment is working correctly,
- that the equipment carries the type approval mark,
- that the installation plaque is affixed,
- that the seals on the equipment and on the other parts of the installation are intact,
- the actual circumference of the tyres.

- (b) An inspection to ensure compliance with the provision of Chapter III (f) 3 on the maximum tolerances in use shall be carried out at least once every six years, although each Member State may stipulate a shorter interval or such inspection in respect of

*Changes to legislation: There are currently no known outstanding effects for the Council Regulation (EEC) No 3821/85. (See end of Document for details)*

vehicles registered in its territory. Such inspections must include replacement of the installation plaque.

#### 4. Measurement of errors

The measurement of errors on installation and during use shall be carried out under the following conditions, which are to be regarded as constituting standard test conditions:

- vehicle unladen, in normal running, order
- tyre pressures in accordance with the manufacturer's instructions,
- tyre wear within the limits allowed by law,
- movement of the vehicle: the vehicle must proceed, driven by its own engine, in a straight line and on a level surface, at a speed of  $50 \pm 5$  km/h; provided that it is of comparable accuracy, the test may also be carried out on an appropriate test bench.

### [<sup>F3</sup>][<sup>F14</sup> ANNEX I B

#### REQUIREMENTS FOR CONSTRUCTION, TESTING, INSTALLATION AND INSPECTION

##### Textual Amendments

**F14** Substituted by [Commission Regulation \(EC\) No 1360/2002 of 13 June 2002 adapting for the seventh time to technical progress Council Regulation \(EEC\) No 3821/85 on recording equipment in road transport \(Text with EEA relevance\)](#).

#### I. DEFINITIONS

In this Annex:

(a) **‘activation’ means** : phase where the recording equipment becomes fully operational and implements all functions, including security functions;

*Activating a recording equipment requires the use of a workshop card and the entry of its PIN code;*

(b) **‘authentication’ means** : a function intended to establish and verify a claimed identity;

(c) **‘authenticity’ means** : the property that an information is coming from a party whose identity can be verified;

(d) **‘built-in-test (BIT)’ means** : tests run at request, triggered by the operator or by an external equipment;

(e) **‘calendar day’ means** : a day ranging from 00.00 hours to 24.00 hours. All calendar days relate to UTC time (universal time coordinated);

[<sup>F15</sup>(f) **‘calibration’ means** : updating or confirming vehicle parameters to be held in the data memory. Vehicle parameters include vehicle identification (VIN, VRN and registering Member State) and vehicle characteristics (w, k, l, tyre size, speed limiting device setting (if applicable), current UTC time, current odometer value);

Any update or confirmation of UTC time only, shall be considered as a time adjustment and not as a calibration, provided it does not contradict Requirement 256.

*Calibrating a recording equipment requires the use of a workshop card;]*



---

*Changes to legislation: There are currently no known outstanding effects for the Council Regulation (EEC) No 3821/85. (See end of Document for details)*

---

- (g) **‘card number’ means** : a 16 alpha-numerical characters number that uniquely identifies a tachograph card within a Member State. The card number includes a consecutive index (if applicable), a replacement index and a renewal index;
- a card is therefore uniquely identified by the code of the issuing Member State and the card number;
- (h) **‘card consecutive index’ means** : the 14th alpha-numerical character of a card number that is used to differentiate the different cards issued to a company or a body entitled to be issued several tachograph cards. The company or the body is uniquely identified by the 13 first characters of the card number;
- (i) **‘card renewal index’ means** : the 16th alpha-numerical character of a card number which is incremented each time a tachograph card is renewed;
- (j) **‘card replacement index’ means** : the 15th alpha-numerical character of a card number which is incremented each time a tachograph card is replaced;
- (k) **‘characteristic coefficient of the vehicle’ means** : the numerical characteristic giving the value of the output signal emitted by the part of the vehicle linking it with the recording equipment (gearbox output shaft or axle) while the vehicle travels a distance of one kilometre under standard test conditions (see Chapter VI(5)). The characteristic coefficient is expressed in impulses per kilometre ( $w = \dots$  imp/km);
- [<sup>F15</sup>(l) **‘company card’ means** : A tachograph card issued by the authorities of a Member State to the owner or holder of vehicles fitted with recording equipment;
- The company card identifies the company and allows for displaying, downloading and printing of the data stored in the recording equipment which has been locked by this company or which has not been locked by any company;]
- (m) **‘constant of the recording equipment’ means** : the numerical characteristic giving the value of the input signal required to show and record a distance travelled of one kilometre; this constant shall be expressed in impulses per kilometre ( $k = \dots$  imp/km);
- (n) **‘continuous driving time’ is computed within the recording equipment as<sup>(11)</sup>** : the continuous driving time is computed as the current accumulated driving times of a particular driver, since the end of his last AVAILABILITY or BREAK/REST or UNKNOWN<sup>(12)</sup> period of 45 minutes or more (this period may have been split in several periods of 15 minutes or more). The computations involved take into account, as needed, past activities stored on the driver card. When the driver has not inserted his card, the computations involved are based on the data memory recordings related to the current period where no card was inserted and related to the relevant slot;
- (o) **‘control card’ means** : a tachograph card issued by the authorities of a Member State to a national competent control authority;
- the control card identifies the control body and possibly the control officer and allows for getting access to the data stored in the data memory or in the driver cards for reading, printing and/or downloading;*
- (p) **‘cumulative break time’ is computed within the recording equipment as<sup>(12)</sup>** : the cumulative break from driving time is computed as the current accumulated AVAILABILITY or BREAK/REST or UNKNOWN<sup>(12)</sup> times of 15 minutes or more of a particular driver, since the end of his last AVAILABILITY or BREAK/REST or UNKNOWN<sup>(12)</sup> period of 45

---

*Changes to legislation: There are currently no known outstanding effects for the Council Regulation (EEC) No 3821/85. (See end of Document for details)*

---

minutes or more (this period may have been split in several periods of 15 minutes or more).

The computations involved take into account, as needed, past activities stored on the driver card. Unknown periods of negative duration (start of unknown period > end of unknown period) due to time overlaps between two different recording equipments, are not taken into account for the computation.

When the driver has not inserted his card, the computations involved are based on the data memory recordings related to the current period where no card was inserted and related to the relevant slot;

- (q) **'data memory' means** : an electronic data storage device built into the recording equipment;
- (r) **'digital signature' means** : data appended to, or a cryptographic transformation of, a block of data that allows the recipient of the block of data to prove the authenticity and integrity of the block of data;
- [<sup>F15</sup>(s) **'downloading' means** : Copying, together with the digital signature, of a part, or of a complete set of data files stored in the data memory of the vehicle or in the memory of the tachograph card, for which these data are necessary to establish compliance with the provisions set out in Regulation (EC) No. 561/2006.

Manufacturers of digital tachograph vehicle units and manufacturers of equipment designed and intended to download data files shall take all reasonable steps to ensure that the downloading of such data can be performed with the minimum delay to transport undertakings or drivers.

Downloading may not alter or delete stored data. The downloading of the detailed speed file may not be necessary to establish compliance with Regulation (EC) No. 561/2006, but may be used for other purposes, such as accident investigation;]

- (t) **'driver card' means** : a tachograph card issued by the authorities of a Member State to a particular driver;

*the driver card identifies the driver and allows for storage of driver activity data;*

- (u) **'effective circumference of the wheel tyres' means** : the average of the distances travelled by each of the wheels moving the vehicle (driving wheels) in the course of one complete rotation. The measurement of these distances shall be made under standard test conditions (Chapter VI(5)) and is expressed in the form 'l = ... mm'. Vehicle manufacturers may replace the measurement of these distances by a theoretical calculation which takes into account the distribution of the weight on the axles, vehicle unladen in normal running order<sup>(13)</sup>. The methods for such theoretical calculation will be approved by a competent Member State authority;

- (v) **'event' means** : abnormal operation detected by the recording equipment which may come from a fraud attempt;

- (w) **'fault' means** : abnormal operation detected by the recording equipment which may come from an equipment malfunction or failure;

- (x) **'installation' means** : mounting of the recording equipment in a vehicle;

- (y) **'motion sensor' means** : part of the recording equipment, providing a signal representative of vehicle speed and/or distance travelled;

---

*Changes to legislation: There are currently no known outstanding effects for the Council Regulation (EEC) No 3821/85. (See end of Document for details)*

---

- (z) **‘non valid card’ means** : a card detected as faulty, or which initial authentication failed, or which start of validity date is not yet reached, or which expiry date has passed;
- (aa) **‘out of scope’ means** : when the use of the recording equipment is not required, according to the provisions of Council Regulation (EEC) No 3820/85;
- (bb) **‘over speeding’ means** : exceeding the authorised speed of the vehicle, defined as any period of more than 60 seconds during which the vehicle's measured speed exceeds the limit for setting the speed limitation device laid down in Council Directive 92/6/EEC of 10 February 1992 on the installation and use of speed limitation devices for certain categories of motor vehicles in the Community<sup>(14)</sup>;
- (cc) **‘periodic inspection’ means** : set of operations performed to control that the recording equipment works properly and that its settings correspond to the vehicle parameters;
- (dd) **‘printer’ means** : component of the recording equipment which provides printouts of stored data;
- (ee) **‘recording equipment’ means** : the total equipment intended for installation in road vehicles to show, record and store automatically or semi-automatically details of the movement of such vehicles and of certain work periods of their drivers;
- (ff) **‘renewal’ means** : issue of a new tachograph card when an existing card reaches its expiry date, or is malfunctioning and has been returned to the issuing authority. Renewal always implies the certainty that two valid cards do not co-exist;
- (gg) **‘repair’ means** : any repair of a motion sensor or of a vehicle unit that requires disconnection of its power supply, or disconnection from other recording equipment components, or opening of it;
- (hh) **‘replacement’ means** : issue of a tachograph card in replacement of an existing card, which has been declared lost, stolen or malfunctioning and has not been returned to the issuing authority. Replacement always implies a risk that two valid cards may co-exist;
- (ii) **‘security certification’ means** : process to certify, by an ITSEC<sup>(15)</sup> certification body, that the recording equipment (or component) or the tachograph card under investigation fulfils the security requirements defined in Appendix 10 Generic security targets;
- (jj) **‘self test’ means** : tests run cyclically and automatically by the recording equipment to detect faults;
- (kk) **‘tachograph card’ means** : smart card intended for use with the recording equipment. Tachograph cards allow for identification by the recording equipment of the identity (or identity group) of the cardholder and allow for data transfer and storage. A tachograph card may be of the following types:  
— driver card,  
— control card,  
— workshop card,  
— company card;
- (ll) **‘type approval’ means** : process to certify, by a Member State, that the recording equipment (or component) or the tachograph card under investigation fulfils the requirements of this regulation;
- (mm) **‘tyre size’ means** : the designation of the dimensions of the tyres (external driving wheels) in accordance with Directive 92/23/EEC of 31 March 1992<sup>(16)</sup>;
- (nn) **‘vehicle identification’ means** : numbers identifying the vehicle: vehicle registration number (VRN) with indication of the registering Member State and vehicle identification number (VIN)<sup>(17)</sup>;

---

*Changes to legislation: There are currently no known outstanding effects for the Council Regulation (EEC) No 3821/85. (See end of Document for details)*

---

(oo)‘**vehicle unit (VU)**’ means : the recording equipment excluding the motion sensor and the cables connecting the motion sensor. The vehicle unit may either be a single unit or be several units distributed in the vehicle, as long as it complies with the security requirements of this regulation;

(pp)for **computing sake in the recording equipment ‘week’ means** : the period between 00.00 hours UTC on Monday and 24.00 UTC on Sunday;

(qq)‘**workshop card**’ means : a tachograph card issued by the authorities of a Member State to a recording equipment manufacturer, a fitter, a vehicle manufacturer or workshop, approved by that Member State.

*The workshop card identifies the cardholder and allows for testing, calibration and/or downloading of the recording equipment;*

[<sup>F16</sup>(rr)‘**adaptor**’ means] : a part of the recording equipment, providing a signal permanently representative of vehicle speed and/or distance travelled, and which is:

- installed and used only in M1 and N1 type vehicles (as defined in Annex II to Council Directive 70/156/EEC) put into service for the first time between 1 May 2006 and [<sup>F17</sup>31 December 2015],
- installed where it is not mechanically possible to install any other type of existing motion sensor which is otherwise compliant with the provisions of this Annex and its Appendixes 1 to 11,
- installed between the vehicle unit and where the speed/distance impulses are generated by integrated sensors or alternative interfaces;

Seen from a vehicle unit, the adaptor behaviour is the same as if a motion sensor, compliant the provisions of this Annex and its Appendixes 1 to 11, was connected to the vehicle unit.

Use of such an adaptor in those vehicles described above shall allow for the installation and correct use of a vehicle unit compliant with all the requirements of this Annex.

For those vehicles, the recording equipment includes cables, an adaptor, and a vehicle unit.]

#### Textual Amendments

**F15** Substituted by Commission Regulation (EU) No 1266/2009 of 16 December 2009 adapting for the tenth time to technical progress Council Regulation (EEC) No 3821/85 on recording equipment in road transport (Text with EEA relevance).

**F16** Inserted by Commission Regulation (EC) No 68/2009 of 23 January 2009 adapting for the ninth time to technical progress Council Regulation (EEC) No 3821/85 on recording equipment in road transport (Text with EEA relevance).

**F17** Substituted by Commission Regulation (EU) No 1161/2014 of 30 October 2014 adapting to technical progress Council Regulation (EEC) No 3821/85 on recording equipment in road transport (Text with EEA relevance).

---

**Changes to legislation:** There are currently no known outstanding effects for the Council Regulation (EEC) No 3821/85. (See end of Document for details)

---

## II. GENERAL CHARACTERISTICS AND FUNCTIONS OF THE RECORDING EQUIPMENT

Any vehicle fitted with the recording equipment complying with the provisions of this Annex, must include a speed display and an odometer. These functions may be included within the recording equipment.

### 1. General characteristics

The purpose of the recording equipment is to record, store, display, print, and output data related to driver activities.

The recording equipment includes cables, a motion sensor, and a vehicle unit.

[<sup>F18</sup>The interface between motion sensors and vehicle units shall be compliant with ISO 16844-3:2004, Cor 1:2006.]

#### Textual Amendments

**F18** Inserted by [Commission Regulation \(EU\) No 1266/2009 of 16 December 2009 adapting for the tenth time to technical progress Council Regulation \(EEC\) No 3821/85 on recording equipment in road transport \(Text with EEA relevance\)](#).

The vehicle unit includes a processing unit, a data memory, a real time clock, two smart card interface devices (driver and co-driver), a printer, a display, a visual warning, a calibration/downloading connector, and facilities for entry of user's inputs.

The recording equipment may be connected to other devices through additional connectors.

Any inclusion in or connection to the recording equipment of any function, device, or devices, approved or otherwise, shall not interfere with, or be capable of interfering with, the proper and secure operation of the recording equipment and the provisions of the Regulation.

Recording equipment users identify themselves to the equipment via tachograph cards.

The recording equipment provides selective access rights to data and functions according to user's type and/or identity.

The recording equipment records and stores data in its data memory and in tachograph cards.

This is done in accordance with Directive 95/46/EC of 24 October 1995 on the protection of individuals with regard to the processing of personal data and on the free movement of such data<sup>(18)</sup>.

### 2. Functions

The recording equipment shall ensure the following functions:

- monitoring cards insertions and withdrawals,
- speed and distance measurement,
- time measurement,
- monitoring driver activities,
- monitoring driving status,
- drivers manual entries:
  - entry of places where daily work periods begin and/or end,

*Changes to legislation: There are currently no known outstanding effects for the Council Regulation (EEC) No 3821/85. (See end of Document for details)*

- manual entry of driver activities,
- entry of specific conditions,
- company locks management,
- monitoring control activities,
- detection of events and/or faults,
- built-in and self tests,
- reading from data memory,
- recording and storing in data memory,
- reading from tachograph cards,
- recording and storing in tachograph cards,
- displaying,
- printing,
- warning,
- data downloading to external media,
- output data to additional external devices,
- calibration,
- time adjustment.

### 3. Modes of operation

The recording equipment shall possess four modes of operation:

- operational mode,
- control mode,
- calibration mode,
- company mode.

The recording equipment shall switch to the following mode of operation according to the valid tachograph cards inserted into the card interface devices:

Mode of operation		Driver slot				
		No card	Driver card	Control card	Workshop card	Company card
Co-driver slot	No card	Operational	Operational	Control	Calibration	Company
	Driver card	Operational	Operational	Control	Calibration	Company
	Control card	Control	Control	Control <sup>a</sup>	Operational	Operational
	Workshop card	Calibration	Calibration	Operational	Calibration <sup>a</sup>	Operational
	Company card	Company	Company	Operational	Operational	Company <sup>a</sup>

<sup>a</sup> In these situations the recording equipment shall use only the tachograph card inserted in the driver slot.

The recording equipment shall ignore non-valid cards inserted, except displaying, printing or downloading data held on an expired card which shall be possible.

All functions listed in II.2. shall work in any mode of operation with the following exceptions:

- the calibration function is accessible in the calibration mode only,
- the time adjustment function is limited when not in the calibration mode,

---

*Changes to legislation: There are currently no known outstanding effects for the Council Regulation (EEC) No 3821/85. (See end of Document for details)*

---

- the company locks management function is accessible in the company mode only,
- the monitoring of control activities function is operational in the control mode only,
- <sup>[F15]</sup>the downloading function is not accessible in the operational mode (except as provided for in Requirement 150), and except downloading a driver card when no other card is inserted into the VU.]

#### Textual Amendments

**F19** Deleted by [Commission Regulation \(EU\) No 1266/2009 of 16 December 2009 adapting for the tenth time to technical progress Council Regulation \(EEC\) No 3821/85 on recording equipment in road transport \(Text with EEA relevance\)](#).

The recording equipment can output any data to display, printer or external interfaces with the following exceptions:

- in the operational mode, any personal identification (surname and first name(s)) not corresponding to a tachograph card inserted shall be blanked and any card number not corresponding to a tachograph card inserted shall be partially blanked (every odd character — from left to right — shall be blanked),
- <sup>[F15]</sup>in the company mode, driver related data (requirements 081, 084 and 087) can be output only for periods where no lock exists or no other company holds a lock (as identified by the first 13 digits of the company card number),]
- when no card is inserted in the recording equipment, driver related data can be output only for the current and eight previous calendar days.

#### 4. Security

The system security aims at protecting the data memory in such a way as to prevent unauthorised access to and manipulation of the data and detecting any such attempts, protecting the integrity and authenticity of data exchanged between the motion sensor and the vehicle unit, protecting the integrity and authenticity of data exchanged between the recording equipment and the tachograph cards, and verifying the integrity and authenticity of data downloaded.

In order to achieve the system security, the recording equipment shall meet the security requirements specified in the motion sensor and vehicle unit generic security targets (Appendix 10).

### III. CONSTRUCTION AND FUNCTIONAL REQUIREMENTS FOR RECORDING EQUIPMENT

#### 1. Monitoring cards insertion and withdrawal

The recording equipment shall monitor the card interface devices to detect card insertions and withdrawals.

Upon card insertion the recording equipment shall detect whether the card inserted is a valid tachograph card and in such a case identify the card type.

The recording equipment shall be so designed that the tachograph cards are locked in position on their proper insertion into the card interface devices.

The release of tachograph cards may function only when the vehicle is stopped and after the relevant data have been stored on the cards. The release of the card shall require positive action by the user.

#### 2. Speed and distance measurement

---

*Changes to legislation: There are currently no known outstanding effects for the Council Regulation (EEC) No 3821/85. (See end of Document for details)*

---

This function shall continuously measure and be able to provide the odometer value corresponding to the total distance travelled by the vehicle.

This function shall continuously measure and be able to provide the speed of the vehicle.

The speed measurement function shall also provide the information whether the vehicle is moving or stopped. The vehicle shall be considered as moving as soon as the function detects more than 1 imp/sec for at least five seconds from the motion sensor, otherwise the vehicle shall be considered as stopped.

Devices displaying speed (speedometer) and total distance travelled (odometer) installed in any vehicle fitted with a recording equipment complying with the provisions of this Regulation, shall comply with the requirements relating to maximum tolerances laid down in this Annex (Chapters III(2)(1) and III(2)(2)).

[<sup>F18</sup>To detect manipulation of motion data, information from the motion sensor shall be corroborated by vehicle motion information derived from one or more source(s) independent from the motion sensor.]

#### 2.1. Measurement of distance travelled

The distance travelled may be measured either:

- so as to cumulate both forward and reverse movements, or
- so as to include only forward movement.

The recording equipment shall measure distance from 0 to 9 999 999,9 km.

Distance measured shall be within the following tolerances (distances of at least 1 000 m):

- $\pm 1$  % before installation,
- $\pm 2$  % on installation and periodic inspection,
- $\pm 4$  % in use.

Distance measured shall have a resolution better than or equal to 0,1 km.

#### 2.2. Measurement of speed

The recording equipment shall measure speed from 0 to 220 km/h.

To ensure a maximum tolerance on speed displayed of  $\pm 6$  km/h in use, and taking into account:

- a  $\pm 2$  km/h tolerance for input variations (tyre variations, ...),
- a  $\pm 1$  km/h tolerance in measurements made during installation or periodic inspections,

the recording equipment shall, for speeds between 20 and 180 km/h, and for characteristic coefficients of the vehicle between 4 000 and 25 000 imp/km, measure the speed with a tolerance of  $\pm 1$  km/h (at constant speed).

Note: The resolution of data storage brings an additional tolerance of  $\pm 0,5$  km/h to speed stored by the recording equipment.

The speed shall be measured correctly within the normal tolerances within 2 seconds of the end of a speed change when the speed has changed at a rate up to  $2 \text{ m/s}^2$ .

Speed measurement shall have a resolution better than or equal to 1 km/h.

### 3. Time measurement



---

*Changes to legislation: There are currently no known outstanding effects for the Council Regulation (EEC) No 3821/85. (See end of Document for details)*

---

The time measurement function shall measure permanently and digitally provide UTC date and time.

[<sup>F15</sup>UTC date and time shall be used for dating data inside the recording equipment (recordings, data exchange) and for all printouts specified in Appendix 4 'Printouts'.]

[<sup>F15</sup>In order to visualise the local time, it shall be possible to change the offset of the time displayed, in half hour steps. No other offsets than negative or positive multiples of half hours shall be allowed.]

Time drift shall be within  $\pm 2$  seconds per day in type approval conditions.

Time measured shall have a resolution better than or equal to 1 second.

Time measurement shall not be affected by an external power supply cut-off of less than 12 months in type approval conditions.

#### 4. Monitoring driver activities

This function shall permanently and separately monitor the activities of one driver and one co-driver.

Driver activity shall be DRIVING, WORK, AVAILABILITY, or BREAK/REST.

It shall be possible for the driver and/or the co-driver to manually select WORK, AVAILABILITY, or BREAK/REST.

When the vehicle is moving, DRIVING shall be selected automatically for the driver and AVAILABILITY shall be selected automatically for the co-driver.

When the vehicle stops, WORK shall be selected automatically for the driver.

[<sup>F15</sup>The first change of activity to REST or AVAILABILITY arising within 120 seconds of the automatic change to WORK due to the vehicle stop shall be assumed to have happened at the time of vehicle stop (therefore possibly cancelling the change to WORK).]

This function shall output activity changes to the recording functions at a resolution of one minute.

[<sup>F19</sup>.....]

[<sup>F15</sup>Given a calendar minute, if DRIVING is registered as the activity of both the immediately preceding and immediately succeeding minute, the whole minute shall be regarded as DRIVING.

Given a calendar minute that is not regarded as DRIVING according to the previous requirement 041, the whole minute shall be regarded to be of the same type of activity as the longest continuous activity within the minute (or the latest of equally long activities).]

This function shall also permanently monitor the continuous driving time and the cumulative break time of the driver.

#### 5. Monitoring driving status

This function shall permanently and automatically monitor the driving status.

The driving status CREW shall be selected when two valid driver cards are inserted in the equipment, the driving status SINGLE shall be selected in any other case.

---

*Changes to legislation: There are currently no known outstanding effects for the Council Regulation (EEC) No 3821/85. (See end of Document for details)*

---

## 6. Drivers manual entries

### 6.1. Entry of places where daily work periods begin and/or end

This function shall allow for the entry of places where the daily work periods begin and/or end for a driver and/or a co-driver.

Places are defined as the country and, in addition where applicable, the region.

At the time of a driver (or workshop) card withdrawal, the recording equipment shall prompt the (co-)driver to enter a 'place where the daily work period ends'.

The recording equipment shall allow this request to be disregarded.

[<sup>F15</sup>It shall be possible to input places where daily work periods begin and/or end through commands in the menus. If more than one such input is done within one calendar minute, only the last begin place input and the last end place input done within that time shall be kept recorded.]

### 6.2. Manual entry of driver activities

[<sup>F15</sup>Upon driver (or workshop) card insertion, and only at this time, the recording equipment shall allow manual entries of activities. It shall be possible to make manual entries, if required, at the first insertion of a previously unused driver (or workshop) card.

Manual entries of activities shall be performed using local time and date values of the time zone (UTC offset) currently set for the vehicle unit.

At driver or workshop card insertion the cardholder shall be reminded of:

- The date and time of his last card withdrawal.
- Optionally: the local time offset currently set for the vehicle unit

It shall be possible to input activities with the following restrictions:

- Activity type shall be WORK, AVAILABILITY or BREAK/REST.
- Start and end times for each activity shall be within the period of the last card withdrawal — current insertion only.

Activities shall not be allowed to overlap mutually in time.

The procedure for manual entries of activities shall include as many consecutive steps as necessary to set a type, a start time and an end time for each activity. For any part of the time period between last card withdrawal and current card insertion, the cardholder shall have the option not to declare any activity.

During the manual entries associated with card insertion and if applicable, the card holder shall have the opportunity to input:

- a place where a previous daily work period ended, associated to the relevant time (if not already entered at the last card withdrawal),
- a place where the current daily work period begins, associated to the relevant time,

If a location is entered, it shall be recorded in the relevant tachograph card.

Manual entries shall be interrupted if:

- the card is withdrawn or,
- the vehicle is moving and the card is in the driver slot.

---

**Changes to legislation:** There are currently no known outstanding effects for the Council Regulation (EEC) No 3821/85. (See end of Document for details)

---

Additional interruptions are allowed, e.g. a timeout after a certain period of user inactivity. If manual entries are interrupted, the recording equipment shall validate any complete place and activity entries (having either unambiguous place and time, or activity type, begin time and end time) already made.

If a second driver or workshop card is inserted while manual entries of activities are in progress for a previously inserted card, the manual entries for this previous card shall be allowed to be completed before manual entries start for the second card.

The cardholder shall have the option to insert manual entries according to the following minimum procedure:

Enter activities manually, in chronological order, for the period last card withdrawal – current insertion.

Begin time of the first activity shall be set to card withdrawal time. For each subsequent entry, the start time shall be preset to immediately follow the end time of the previous entry. Activity type and end time shall be selected for each activity.

The procedure shall end when the end time of a manually entered activity equals the card insertion time. The recording equipment may then optionally allow the card holder to modify any activity manually entered, until validation by selection of a specific command. Thereafter, any such modification shall be forbidden.]

### 6.3. Entry of specific conditions

[<sup>F15</sup>The recording equipment shall allow the driver to enter, in real time, the following two specific conditions:

‘OUT OF SCOPE’ (begin, end)

‘FERRY / TRAIN CROSSING’

A ‘FERRY / TRAIN CROSSING’ may not occur if an ‘OUT OF SCOPE’ condition is opened.

An opened ‘OUT OF SCOPE’ condition shall be automatically closed, by the recording equipment, if a driver card is inserted or withdrawn.

An opened ‘OUT OF SCOPE’ condition shall inhibit the following events and warnings:

- Driving without an appropriate card,
- Warnings associated with continuous driving time.]

### 7. Company locks management

This function shall allow the management of the locks placed by a company to restrict data access in company mode to itself.

Company locks consist in a start date/time (lock-in) and an end date/time (lock-out) associated with the identification of the company as denoted by the company card number (at lock-in).

Locks may be turned ‘in’ or ‘out’ in real time only.

Locking-out shall only be possible for the company whose lock is ‘in’ (as identified by the first 13 digits of the company card number), or,

locking-out shall be automatic if another company locks in.

In the case where a company locks in and where the previous lock was for the same company, then it will be assumed that the previous lock has not been turned ‘out’ and is still ‘in’.

*Changes to legislation: There are currently no known outstanding effects for the Council Regulation (EEC) No 3821/85. (See end of Document for details)*

## 8. Monitoring control activities

This function shall monitor DISPLAYING, PRINTING, VU and card DOWNLOADING activities carried while in control mode.

This function shall also monitor OVER SPEEDING CONTROL activities while in control mode. An over speeding control is deemed to have happened when, in control mode, the 'over speeding' printout has been sent to the printer or to the display, or when 'events and faults' data have been downloaded from the VU data memory.

## 9. Detection of events and/or faults

This function shall detect the following events and/or faults:

### 9.1. Insertion of a non-valid card' event

This event shall be triggered at the insertion of any non-valid card and/or when an inserted valid card expires.

### 9.2. 'Card conflict' event

This event shall be triggered when any of the valid cards combination noted X in the following table arise:

Card conflict		Driver slot				
		No card	Driver card	Control card	Workshop card	Company card
Co-driver slot	No card					
	Driver card				X	
	Control card			X	X	X
	Workshop card		X	X	X	X
	Company card			X	X	X

### 9.3. 'Time overlap' event

This event shall be triggered when the date/time of last withdrawal of a driver card, as read from the card, is later than the current date/time of the recording equipment in which the card is inserted.

### 9.4. 'Driving without an appropriate card' event

This event shall be triggered for any tachograph cards combination noted X in the following table, when driver activity changes to DRIVING, or when there is a change of the mode of operation while driver activity is DRIVING:

Driving without an appropriate card	Driver slot				
	No (or non-valid) card	Driver card	Control card	Workshop card	Company card

*Changes to legislation: There are currently no known outstanding effects for the Council Regulation (EEC) No 3821/85. (See end of Document for details)*

<b>Co-driver slot</b>	<b>No (or non-valid) card</b>	X		X		X
	<b>Driver card</b>	X		X	X	X
	<b>Control card</b>	X	X	X	X	X
	<b>Workshop card</b>	X	X	X		X
	<b>Company card</b>	X	X	X	X	X

#### 9.5. 'Card insertion while driving' event

This event shall be triggered when a tachograph card is inserted in any slot, while driver activity is DRIVING.

#### 9.6. 'Last card session not correctly closed' event

This event shall be triggered when at card insertion the recording equipment detects that, despite the provisions laid down in paragraph III(1), the previous card session has not been correctly closed (the card has been withdrawn before all relevant data have been stored on the card). This event shall be triggered by driver and workshop cards only.

#### 9.7. 'Over speeding' event

[<sup>F15</sup>This event shall be triggered for each over-speeding. This requirement shall apply only to vehicles falling within category M2, M3, N2 or N3, as defined in Annex II of Directive 2007/46/EC, establishing a framework for the approval of motor vehicles and their trailers.]

#### 9.8. 'Power supply interruption' event

This event shall be triggered, while not in calibration mode, in case of any interruption exceeding 200 milliseconds of the power supply of the motion sensor and/or of the vehicle unit. The interruption threshold shall be defined by the manufacturer. The drop in power supply due to the starting of the engine of the vehicle shall not trigger this event.

#### 9.9. 'Motion data error' event

This event shall be triggered in case of interruption of the normal data flow between the motion sensor and the vehicle unit and/or in case of data integrity or data authentication error during data exchange between the motion sensor and the vehicle unit.

#### [<sup>F18</sup>9.9 'Vehicle Motion Conflict' event bis.

This event shall also be triggered when a zero speed measurement is contradicted by motion information from at least one independent source for more than one uninterrupted minute.

In cases where the vehicle unit can receive or elaborate speed values from external independent source of motion information, this event may also be triggered if such speed values significantly contradict those elaborated from the motion sensor speed signal for more than one minute.]

#### 9.10. 'Security breach attempt' event

---

*Changes to legislation: There are currently no known outstanding effects for the Council Regulation (EEC) No 3821/85. (See end of Document for details)*

---

This event shall be triggered for any other event affecting the security of the motion sensor and/or of the vehicle unit as specified within the generic security targets of these components, while not in calibration mode.

#### 9.11. 'Card' fault

This fault shall be triggered when a tachograph card failure occurs during operation.

#### 9.12. 'Recording equipment' fault

This fault shall be triggered for any of these failures, while not in calibration mode:

- VU internal fault,
- printer fault,
- display fault,
- downloading fault,
- sensor fault.

#### 10. Built-in and self tests

The recording equipment shall self-detect faults through self tests and built-in-tests, according to the following table:

<b>Sub-assembly to test</b>	<b>Self test</b>	<b>Built-in-test</b>
Software		Integrity
Data memory	Access	Access, data integrity
Card interface devices	Access	Access
Keyboard		Manual check
Printer	(up to manufacturer)	Printout
Display		Visual check
Downloading (performed only during downloading)	Proper operation	
Sensor	Proper operation	Proper operation

#### 11. Reading from data memory

The recording equipment shall be able to read any data stored in its data memory.

#### 12. Recording and storing in the data memory

For the purpose of this paragraph,

- '365 days' is defined as 365 calendar days of average drivers activity in a vehicle. The average activity per day in a vehicle is defined as at least six drivers or co-drivers, six card insertion withdrawal cycles, and 256 activity changes. '365 days' therefore include at least 2 190 (co-)drivers, 2 190 card insertion withdrawal cycles, and 93 440 activity changes,
- times are recorded with a resolution of one minute, unless otherwise specified,
- odometer values are recorded with a resolution of one kilometre,
- speeds are recorded with a resolution of 1 km/h.

---

**Changes to legislation:** There are currently no known outstanding effects for the Council Regulation (EEC) No 3821/85. (See end of Document for details)

---

Data stored into the data memory shall not be affected by an external power supply cut-off of less than twelve months in type approval conditions.

The recording equipment shall be able to record and store implicitly or explicitly in its data memory the following:

#### 12.1. Equipment identification data

##### 12.1.1. Vehicle unit identification data

The recording equipment shall be able to store in its data memory the following vehicle unit identification data:

- name of the manufacturer,
- address of the manufacturer,
- part number,
- serial number,
- software version number,
- software version installation date,
- year of equipment manufacture,
- approval number.

Vehicle unit identification data are recorded and stored once and for all by the vehicle unit manufacturer, except the software-related data and the approval number which may be changed in case of software upgrade.

##### 12.1.2. Motion sensor identification data

The motion sensor shall be able to store in its memory the following identification data:

- name of the manufacturer,
- part number,
- serial number,
- approval number,
- embedded security component identifier (e.g. internal chip/processor part number),
- operating system identifier (e.g. software version number).

Motion sensor identification data are recorded and stored once and for all in the motion sensor, by the motion sensor manufacturer.

The vehicle unit shall be able to record and store in its data memory the following currently paired motion sensor identification data:

- serial number,
- approval number,
- first pairing date.

#### 12.2. Security elements

The recording equipment shall be able to store the following security elements:

- European public key,
- Member State certificate,
- equipment certificate,
- equipment private key.

---

*Changes to legislation: There are currently no known outstanding effects for the Council Regulation (EEC) No 3821/85. (See end of Document for details)*

---

Recording equipment security elements are inserted in the equipment by the vehicle unit manufacturer.

### 12.3. Driver card insertion and withdrawal data

For each insertion and withdrawal cycle of a driver or workshop card in the equipment, the recording equipment shall record and store in its data memory:

- the card holder's surname and first name(s) as stored in the card,
- the card's number, issuing Member State and expiry date as stored in the card,
- the insertion date and time,
- the vehicle odometer value at card insertion,
- the slot in which the card is inserted,
- the withdrawal date and time,
- the vehicle odometer value at card withdrawal,
- the following information about the previous vehicle used by the driver, as stored in the card:
  - VRN and registering Member State,
  - card withdrawal date and time,
- a flag indicating whether, at card insertion, the card holder has manually entered activities or not.

The data memory shall be able to hold these data for at least 365 days.

When storage capacity is exhausted, new data shall replace oldest data.

### 12.4. Driver activity data

The recording equipment shall record and store in its data memory whenever there is a change of activity for the driver and/or the co-driver, and/or whenever there is a change of driving status, and/or whenever there is an insertion or withdrawal of a driver or workshop card:

- the driving status (CREW, SINGLE),
- the slot (DRIVER, CO-DRIVER),
- the card status in the relevant slot (INSERTED, NOT INSERTED) (see Note),
- the activity (DRIVING, AVAILABILITY, WORK, BREAK/REST),
- the date and time of the change.

Note: INSERTED means that a valid driver or workshop card is inserted in the slot. NOT INSERTED means the opposite, i.e. no valid driver or workshop card is inserted in the slot (e.g. a company card is inserted or no card is inserted).

Note: Activity data manually entered by a driver are not recorded in the data memory.

The data memory shall be able to hold driver activity data for at least 365 days.

When storage capacity is exhausted, new data shall replace oldest data.

### 12.5. Places where daily work periods start and/or end

The recording equipment shall record and store in its data memory whenever a (co-)driver enters the place where a daily work period begins and/or ends:

- if applicable, the (co-)driver card number and card issuing Member State,
- the date and time of the entry (or the date/time related to the entry when the entry is made during the manual entry procedure),
- the type of entry (begin or end, condition of entry),



**Changes to legislation:** There are currently no known outstanding effects for the Council Regulation (EEC) No 3821/85. (See end of Document for details)

- the country and region entered,
- the vehicle odometer value.

The data memory shall be able to hold daily work periods start and/or end data for at least 365 days (with the assumption that one driver enters two records per day).

When storage capacity is exhausted, new data shall replace oldest data.

#### 12.6. Odometer data

The recording equipment shall record in its data memory the vehicle odometer value and the corresponding date at midnight every calendar day.

The data memory shall be able to store midnight odometer values for at least 365 calendar days.

When storage capacity is exhausted, new data shall replace oldest data.

#### 12.7. Detailed speed data

The recording equipment shall record and store in its data memory the instantaneous speed of the vehicle and the corresponding date and time at every second of at least the last 24 hours that the vehicle has been moving.

#### 12.8. Events data

For the purpose of this subparagraph, time shall be recorded with a resolution of one second.

The recording equipment shall record and store in its data memory the following data for each event detected according to the following storage rules:

Event	Storage rules	Data to be recorded per event
Card conflict	— the 10 most recent events.	— date and time of beginning of event, — date and time of end of event, — cards' type, number and issuing Member State of the two cards creating the conflict.
Driving without an appropriate card	— the longest event for each of the 10 last days of occurrence, — the five longest events over the last 365 days.	— date and time of beginning of event, — date and time of end of event, — cards' type, number and issuing Member State of any card inserted at beginning and/or end of the event,

**a** The recording equipment shall also record and store in its data memory:

- the date and time of the last OVER SPEEDING CONTROL,
- the date and time of the first over speeding following this OVER SPEEDING CONTROL,
- the number of over speeding events since the last OVER SPEEDING CONTROL.

**b** These data may be recorded at power supply reconnection only, times may be known with an accuracy to the minute.

**Changes to legislation:** There are currently no known outstanding effects for the Council Regulation (EEC) No 3821/85. (See end of Document for details)

		— number of similar events that day.
Card insertion while driving	— the last event for each of the 10 last days of occurrence.	— date and time of the event, — card's type, number and issuing Member State, — number of similar events that day.
Last card session not correctly closed	— the 10 most recent events.	— date and time of card insertion, — card's type, number and issuing Member State, — last session data as read from the card: — date and time of card insertion, — VRN and Member State of registration.
Over speeding <sup>a</sup>	— the most serious event for each of the 10 last days of occurrence (i.e. the one with the highest average speed), — the five most serious events over the last 365 days. — the first event having occurred after the last calibration.	— date and time of beginning of event, — date and time of end of event, — maximum speed measured during the event, — arithmetic average speed measured during the event, — card's type, number and issuing Member State of the driver (if applicable), — number of similar events that day.
Power supply interruption <sup>b</sup>	— the longest event for each of the 10 last days of occurrence,	— date and time of beginning of event, — date and time of end of event, — cards' type, number and issuing Member

- a** The recording equipment shall also record and store in its data memory:
- the date and time of the last OVER SPEEDING CONTROL,
  - the date and time of the first over speeding following this OVER SPEEDING CONTROL,
  - the number of over speeding events since the last OVER SPEEDING CONTROL.

- b** These data may be recorded at power supply reconnection only, times may be known with an accuracy to the minute.

**Changes to legislation:** There are currently no known outstanding effects for the Council Regulation (EEC) No 3821/85. (See end of Document for details)

	— the five longest events over the last 365 days.	— State of any card inserted at beginning and/or end of the event, number of similar events that day.
Motion data error	— the longest event for each of the 10 last days of occurrence, — the five longest events over the last 365 days.	— date and time of beginning of event, — date and time of end of event, — cards' type, number and issuing Member State of any card inserted at beginning and/or end of the event, — number of similar events that day.
[ <sup>F18</sup> Vehicle Motion Conflict	— the longest event for each of the 10 last days of occurrence, — the 5 longest events over the last 365 days.	— date and time of beginning of event, — date and time of end of event, — cards' type, number and issuing Member State of any card inserted at beginning and/or end of the event, — number of similar events that day.]
Security breach attempt	— the 10 most recent events per type of event.	— date and time of beginning of event, — date and time of end of event (if relevant), — cards' type, number and issuing Member State of any card inserted at beginning and/or end of the event, — type of event.

- a** The recording equipment shall also record and store in its data memory:
- the date and time of the last OVER SPEEDING CONTROL,
  - the date and time of the first over speeding following this OVER SPEEDING CONTROL,
  - the number of over speeding events since the last OVER SPEEDING CONTROL.

- b** These data may be recorded at power supply reconnection only, times may be known with an accuracy to the minute.

## 12.9. Faults data

For the purpose of this subparagraph, time shall be recorded with a resolution of one second.

*Changes to legislation: There are currently no known outstanding effects for the Council Regulation (EEC) No 3821/85. (See end of Document for details)*

The recording equipment shall attempt to record and store in its data memory the following data for each fault detected according to the following storage rules:

<b>Fault</b>	<b>Storage rules</b>	<b>Data to be recorded per fault</b>
Card fault	— the 10 most recent driver card faults.	— date and time of beginning of fault, — date and time of end of fault, — card's type number and issuing Member State.
Recording equipment faults	— the 10 most recent faults for each type of fault, — the first fault after the last calibration.	— date and time of beginning of fault, — date and time of end of fault, — type of fault, — cards' type, number and issuing Member State of any card inserted at beginning and/or end of the fault.

#### 12.10. Calibration data

The recording equipment shall record and store in its data memory data relevant to:

- known calibration parameters at the moment of activation,
- its very first calibration following its activation,
- its first calibration in the current vehicle (as identified by its VIN),
- the five most recent calibrations (If several calibrations happen within one calendar day, only the last one of the day shall be stored).

The following data shall be recorded for each of these calibrations:

- purpose of calibration (activation, first installation, installation, periodic inspection),
- workshop name and address,
- workshop card number, card issuing Member State and card expiry date,
- vehicle identification,
- parameters updated or confirmed: w, k, l, tyre size, speed limiting device setting, odometer (old and new values), date and time (old and new values).

The motion sensor shall record and store in its memory the following motion sensor installation data:

- first pairing with a VU (date, time, VU approval number, VU serial number),
- last pairing with a VU (date, time, VU approval number, VU serial number).

#### 12.11. Time adjustment data

The recording equipment shall record and store in its data memory data relevant to:

- the most recent time adjustment,

---

*Changes to legislation: There are currently no known outstanding effects for the Council Regulation (EEC) No 3821/85. (See end of Document for details)*

---

— the five largest time adjustments, since last calibration, performed in calibration mode outside the frame of a regular calibration (definition (f)).

The following data shall be recorded for each of these time adjustments:

- date and time, old value,
- date and time, new value,
- workshop name and address,
- workshop card number, card issuing Member State and card expiry date.

#### 12.12. Control activity data

The recording equipment shall record and store in its data memory the following data relevant to the 20 most recent control activities:

- date and time of the control,
- control card number and card issuing Member State,
- type of the control (displaying and/or printing and/or VU downloading and/or card downloading).

In case of downloading, the dates of the oldest and of the most recent days downloaded shall also be recorded.

#### 12.13. Company locks data

[<sup>F15</sup>The recording equipment shall record and store in its data memory the following data relevant to the 255 most recent company locks:

- lock-in date and time,
- lock-out date and time,
- Company Card number and card issuing Member States,
- Company name and address.

Data previously locked by a lock removed from memory due to the limit above, shall be treated as not locked.]

#### 12.14. Download activity data

The recording equipment shall record and store in its data memory the following data relevant to the last data memory downloading to external media while in company or in calibration mode:

- date and time of downloading,
- company or workshop card number and card issuing Member State,
- company or workshop name.

#### 12.15. Specific conditions data

The recording equipment shall record in its data memory the following data relevant to specific conditions:

- date and time of the entry,
- type of specific condition.

The data memory shall be able to hold specific conditions data for at least 365 days (with the assumption that on average, one condition is opened and closed per day). When storage capacity is exhausted, new data shall replace oldest data.

### 13. Reading from tachograph cards

---

*Changes to legislation: There are currently no known outstanding effects for the Council Regulation (EEC) No 3821/85. (See end of Document for details)*

---

The recording equipment shall be able to read from tachograph cards, where applicable, the necessary data:

- to identify the card type, the card holder, the previously used vehicle, the date and time of the last card withdrawal and the activity selected at that time,
- to check that last card session was correctly closed,
- to compute the driver's continuous driving time, cumulative break time and cumulated driving times for the previous and the current week,
- to print requested printouts related to data recorded on a driver card,
- to download a driver card to external media.

In case of a reading error, the recording equipment shall try again, three times maximum, the same read command, and then if still unsuccessful, declare the card faulty and non-valid.

#### 14. Recording and storing on tachograph cards

The recording equipment shall set the 'card session data' in the driver or workshop card right after the card insertion.

The recording equipment shall update data stored on valid driver, workshop and/or control cards with all necessary data relevant to the period while the card is inserted and relevant to the card holder. Data stored on these cards are specified in Chapter IV.

The recording equipment shall update driver activity and location data (as specified in Chapter IV, paragraphs 5.2.5 and 5.2.6), stored on valid driver and/or workshop cards, with activity and location data manually entered by the cardholder.

[<sup>F18</sup>The 'Vehicle Motion Conflict' event shall not be stored on the driver and workshop cards.]

Tachograph cards data update shall be such that, when needed and taking into account card actual storage capacity, most recent data replace oldest data.

In the case of a writing error, the recording equipment shall try again, three times maximum, the same write command, and then if still unsuccessful, declare the card faulty and non valid.

Before releasing a driver card, and after all relevant data have been stored on the card, the recording equipment shall reset the card session data.

#### 15. Displaying

The display shall include at least 20 characters.

The minimum character size shall be 5 mm high and 3,5 mm wide.

[<sup>F15</sup>The display shall support the characters specified in Appendix 1 Chapter 4 'Character sets'. The display may use simplified glyphs (e.g. accented characters may be displayed without accent, or lower case letters may be shown as upper case letters).]

The display shall be provided with adequate non-dazzling lighting.

Indications shall be visible from outside the recording equipment.

The recording equipment shall be able to display:

- default data,
- data related to warnings,
- data related to menu access,
- other data requested by a user.

Additional information may be displayed by the recording equipment, provided that it is clearly distinguishable from information required above.

The display of the recording equipment shall use the pictograms or pictogram combinations listed in Appendix 3. Additional pictograms or pictogram combinations may also be provided by the display, if clearly distinguishable from the aforementioned pictogram or pictogram combinations.

The display shall always be ON when the vehicle is moving.

The recording equipment may include a manual or automatic feature to turn the display OFF when the vehicle is not moving.

Displaying format is specified in Appendix 5.

#### 15.1. Default display

[<sup>F15</sup>When no other information needs to be displayed, the recording equipment shall display, by default, the following:

- the local time (as a result of UTC time + offset as set by the driver),
- the mode of operation,
- the current activity of the driver and the current activity of the co-driver.

Information related to the driver:

- if his current activity is DRIVING, his current continuous driving time and his current cumulative break time,
- if his current activity is not DRIVING, the current duration of this activity (since it was selected) and his current cumulative break time.]

Display of data related to each driver shall be clear, plain and unambiguous. In the case where the information related to the driver and the co-driver cannot be displayed at the same time, the recording equipment shall display by default the information related to the driver and shall allow the user to display the information related to the co-driver.

In the case where the display width does not allow to display by default the mode of operation, the recording equipment shall briefly display the new mode of operation when it changes.

The recording equipment shall briefly display the card holder name at card insertion.

When an 'OUT OF SCOPE' condition is opened, then the default display must show using the relevant pictogram that the condition is opened (It is acceptable that the driver's current activity may not be shown at the same time).

#### 15.2. Warning display

The recording equipment shall display warning information using primarily the pictograms of Appendix 3, completed where needed by an additional numerically coded information. A literal description of the warning may also be added in the driver's preferred language.

#### 15.3. Menu access

The recording equipment shall provide necessary commands through an appropriate menu structure.

#### 15.4. Other displays

[<sup>F15</sup>It shall be possible to display selectively on request:

---

*Changes to legislation: There are currently no known outstanding effects for the Council Regulation (EEC) No 3821/85. (See end of Document for details)*

---

- the UTC date and time, and local time offset,
- the content of any of the six printouts under the same formats as the printouts themselves,
- the continuous driving time and cumulative break time of the driver,
- the continuous driving time and cumulative break time of the co-driver,
- the cumulated driving time of the driver for the previous and the current week,
- the cumulated driving time of the co-driver for the previous and the current week.

Optional:

- the current duration of co-driver activity (since it was selected),
- the cumulated driving time of the driver for the current week,
- the cumulated driving time of the driver for the current daily work period,
- the cumulated driving time of the co-driver for the current daily work period.]

Printout content display shall be sequential, line by line. If the display width is less than 24 characters the user shall be provided with the complete information through an appropriate mean (several lines, scrolling, ...). Printout lines devoted to hand-written information may be omitted for display.

## 16. Printing

The recording equipment shall be able to print information from its data memory and/or from tachograph cards in accordance with the six following printouts:

- driver activities from card daily printout,
- driver activities from Vehicle Unit daily printout,
- events and faults from card printout,
- events and faults from Vehicle Unit printout,
- technical data printout,
- over speeding printout.

The detailed format and content of these printouts are specified in Appendix 4.

Additional data may be provided at the end of the printouts

Additional printouts may also be provided by the recording equipment, if clearly distinguishable from the six aforementioned printouts.

The 'driver activities from card daily printout' and 'events and faults from card printout' shall be available only when a driver card or a workshop card is inserted in the recording equipment. The recording equipment shall update data stored on the relevant card before starting printing.

In order to produce the 'driver activities from card daily printout' or the 'events and faults from card printout', the recording equipment shall:

- either automatically select the driver card or the workshop card if one only of these cards is inserted,
- or provide a command to select the source card or select the card in the driver slot if two of these cards are inserted in the recording equipment.

The printer shall be able to print 24 characters per line.

The minimum character size shall be 2,1 mm high and 1,5 mm wide.

[<sup>F15</sup>The printer shall support the characters specified in Appendix 1 Chapter 4 'Character sets'.]



---

*Changes to legislation: There are currently no known outstanding effects for the Council Regulation (EEC) No 3821/85. (See end of Document for details)*

---

Printers shall be so designed as to produce these printouts with a degree of definition likely to avoid any ambiguity when they are read.

Printouts shall retain their dimensions and recordings under normal conditions of humidity (10 to 90 %) and temperature.

[<sup>F15</sup>The printout paper used by the recording equipment shall bear the relevant type approval mark and an indication of the type(s) of recording equipment with which it may be used.]

[<sup>F18</sup>Printouts shall remain clearly legible and identifiable under normal conditions of storage, in terms of light intensity, humidity and temperature, for at least two years.

The printout paper shall conform at least to the test specifications defined on the website of the laboratory appointed to carry out interoperability testing, as set out in Requirement 278.

Any amendment or updating of the specifications described in the above paragraph shall only be made after the appointed laboratory has consulted the type approved digital tachograph vehicle unit manufacturer in conjunction with the type approval authorities.]

It shall also be possible to add handwritten notes, such as the driver's signature, to these documents.

The recording equipment shall manage 'paper out' events while printing by, once paper has been re-loaded, restarting printing from printout beginning or by continuing printing and providing an unambiguous reference to previously printed part.

#### 17. Warnings

The recording equipment shall warn the driver when detecting any event and/or fault.

Warning of a power supply interruption event may be delayed until the power supply is reconnected.

[<sup>F15</sup>The recording equipment shall warn the driver 15 minutes before and at the time of exceeding the maximum allowed continuous driving time.]

Warnings shall be visual. Audible warnings may also be provided in addition to visual warnings.

Visual warnings shall be clearly recognisable by the user, shall be situated in the driver's field of vision and shall be clearly legible both by day and by night.

Visual warnings may be built into the recording equipment and/or remote from the recording equipment.

[<sup>F15</sup>In the latter case it shall bear a 'T' symbol.]

Warnings shall have a duration of at least 30 seconds, unless acknowledged by the user by hitting any key of the recording equipment. This first acknowledgement shall not erase warning cause display referred to in next paragraph.

Warning cause shall be displayed on the recording equipment and remain visible until acknowledged by the user using a specific key or command of the recording equipment.

Additional warnings may be provided, as long as they do not confuse drivers in relation to previously defined ones.

#### 18. Data downloading to external media

---

*Changes to legislation: There are currently no known outstanding effects for the Council Regulation (EEC) No 3821/85. (See end of Document for details)*

---

The recording equipment shall be able to download on request data from its data memory or from a driver card to external storage media via the calibration/downloading connector. The recording equipment shall update data stored on the relevant card before starting downloading.

In addition and as an optional feature, the recording equipment may, in any mode of operation, download data through another connector to a company authenticated through this channel. In such a case, company mode data access rights shall apply to this download.

Downloading shall not alter or delete any stored data.

The calibration/downloading connector electrical interface is specified in Appendix 6.

Downloading protocols are specified in Appendix 7.

#### 19. Output data to additional external devices

When the recording equipment does not include speed and/or odometer display functions, the recording equipment shall provide output signal(s) to allow for displaying the speed of the vehicle (speedometer) and/or the total distance travelled by the vehicle (odometer).

The vehicle unit shall also be able to output the following data using an appropriate dedicated serial link independent from an optional CAN bus connection (ISO 11898 Road vehicles — Interchange of digital information — Controller Area Network (CAN) for high speed communication), to allow their processing by other electronic units installed in the vehicle:

- current UTC date and time,
- speed of the vehicle,
- total distance travelled by the vehicle (odometer),
- currently selected driver and co-driver activity,
- information if any tachograph card is currently inserted in the driver slot and in the co-driver slot and (if applicable) information about the corresponding cards identification (card number and issuing Member State).

Other data may also be output in addition to this minimum list.

When the ignition of the vehicle is ON, these data shall be permanently broadcast. When the ignition of the vehicle is OFF, at least any change of driver or co-driver activity and/or any insertion or withdrawal of a tachograph card shall generate a corresponding data output. In the event that data output has been withheld whilst the ignition of the vehicle is OFF, that data shall be made available once the ignition of the vehicle is ON again.

#### 20. Calibration

The calibration function shall allow:

- to automatically pair the motion sensor with the VU,
- to digitally adapt the constant of the recording equipment (k) to the characteristic coefficient of the vehicle (w) (vehicles with two or more axle ratios shall be fitted with a switch device whereby these various ratios will automatically be brought into line with the ratio for which the equipment has been adapted to the vehicle),
- to adjust (without limitation) the current time,
- to adjust the current odometer value,
- to update motion sensor identification data stored in the data memory,
- to update or confirm other parameters known to the recording equipment: vehicle identification, w, l, tyre size and speed limiting device setting if applicable.

---

*Changes to legislation: There are currently no known outstanding effects for the Council Regulation (EEC) No 3821/85. (See end of Document for details)*

---

Pairing the motion sensor to the VU shall consist, at least, in:

- updating motion sensor installation data held by the motion sensor (as needed),
- copying from the motion sensor to the VU data memory necessary motion sensor identification data.

The calibration function shall be able to input necessary data through the calibration/downloading connector in accordance with the calibration protocol defined in Appendix 8. The calibration function may also input necessary data through other connectors.

#### 21. Time adjustment

The time adjustment function shall allow for adjusting the current time in amounts of one minute maximum at intervals of not less than seven days.

The time adjustment function shall allow for adjusting the current time without limitation, in calibration mode.

#### 22. Performance characteristics

The Vehicle Unit shall be fully operational in the temperature range - 20 °C to 70 °C, and the motion sensor in the temperature range - 40 °C to 135 °C. Data memory content shall be preserved at temperatures down to - 40 °C.

The recording equipment shall be fully operational in the humidity range 10 % to 90 %.

The recording equipment shall be protected against over-voltage, inversion of its power supply polarity, and short circuits.

[<sup>F18</sup>Motion sensors shall either:

- react to a magnetic field which disturbs vehicle motion detection. In such circumstances, the vehicle unit will record and store a sensor fault (Requirement 070) or,

have a sensing element that is protected from, or immune to, magnetic fields.]

The recording equipment shall conform to Commission Directive 95/54/EC of 31 October 1995<sup>(19)</sup> adapting to technical progress Council Directive 72/245/EEC<sup>(20)</sup>, related to electromagnetic compatibility, and shall be protected against electrostatic discharges and transients.

#### 23. Materials

All the constituent parts of the recording equipment shall be made of materials of sufficient stability and mechanical strength and with stable electrical and magnetic characteristics.

For normal conditions of use, all the internal parts of the equipment shall be protected against damp and dust.

The Vehicle Unit shall meet the protection grade IP 40 and the motion sensor shall meet the protection grade IP 64, as per standard IEC 529.

The recording equipment shall conform to applicable technical specifications related to ergonomic design.

The recording equipment shall be protected against accidental damage.

#### 24. Markings

*Changes to legislation: There are currently no known outstanding effects for the Council Regulation (EEC) No 3821/85. (See end of Document for details)*

If the recording equipment displays the vehicle odometer value and speed, the following details shall appear on its display:

- near the figure indicating the distance, the unit of measurement of distance, indicated by the abbreviation 'km',
- near the figure showing the speed, the entry 'km/h'.

The recording equipment may also be switched to display the speed in miles per hour, in which case the unit of measurement of speed shall be shown by the abbreviation 'mph'.

A descriptive plaque shall be affixed to each separate component of the recording equipment and shall show the following details:

- name and address of the manufacturer of the equipment,
- manufacturer's part number and year of manufacture of the equipment,
- equipment serial number,
- approval mark for the equipment type.

When physical space is not sufficient to show all abovementioned details, the descriptive plaque shall show at least: the manufacturer's name or logo, and the equipment's part number.

#### IV. CONSTRUCTION AND FUNCTIONAL REQUIREMENTS FOR TACHOGRAPH CARDS

##### 1. Visible data

The front page will contain:

the words 'Driver card' or 'Control card' or 'Workshop card' or 'Company card' printed in large type in the official language or languages of the Member State issuing the card, according to the type of the card;

<sup>F20</sup><sup>F21</sup> the same words in the other official languages of the Community, printed to form the background of the card:

BG	КАРТА НА ВОДАЧА	КОНТРОЛНА КАРТА	КАРТА ЗА МОНТАЖ И НАСТРОЙКИ	КАРТА НА ПРЕВОЗВАЧА
ES	TARJETA DEL CONDUCTOR	TARJETA DE CONTROL	TARJETA DEL CENTRO DE ENSAYO	TARJETA DE LA EMPRESA
CS	KARTA ŘIDIČE	KONTROLNÍ KARTA	KARTA DÍLNÝ	KARTA PODNIKU
DA	FØRERKORT	KONTROLKORT	VÆRKSTEDSKORT	FIRKSOMHEDSKORT
DE	FAHRERKART	KONTROLLKART	WERKSTATTKART	UNTERNEHMENSKARTE
ET	AUTOJUHI KAART	KONTROLLIJAKAART	TÖÖKOJAKAART	TÖÖANDJAKAART
EL	ΚΑΡΤΑ ΟΔΗΓΟΥ	ΚΑΡΤΑ ΕΛΕΓΧΟΥ	ΚΑΡΤΑ ΚΕΝΤΡΟΥ ΔΟΚΙΜΩΝ	ΚΑΡΤΑ ΕΠΙΧΕΙΡΗΣΗΣ
EN	DRIVER CARD	CONTROL CARD	WORKSHOP CARD	COMPANY CARD

**Changes to legislation:** There are currently no known outstanding effects for the Council Regulation (EEC) No 3821/85. (See end of Document for details)

FR	CARTE DE CONDUCTEUR	CARTE DE CONTROLEUR	CARTE D'ATELIER	CARTE D'ENTREPRISE
HR	KARTICA VOZAČA	NADZORNA KARTICA	KARTICA RADIONICE	KARTICA PRIJEVOZNIKA
GA	CÁRTA TIOMÁNAÍ	CÁRTA STIÚRTHA	CÁRTA CEARDLAINNE	CÁRTA COMHLACHTA
IT	CARTA DEL CONDUCENTE	CARTA DI CONTROLLO	CARTA DELL'OFFICINA	CARTA DELL'AZIENDA
LV	VADĪTĀJA KARTE	KONTROLKARTE	DARBNĪCAS KARTE	UZŅĒMUMA KARTE
LT	VAIRUOTOJO KORTELĖ	KONTROLĖS KORTELĖ	DIRBTUVĖS KORTELĖ	ĮMONĖS KORTELĖ
HU	GÉPJÁRMŰVEZŐ KÁRTYA	ZELŐNŐRI KÁRTYA	MŰHELYKÁRTYA	ÜZEMBENTARTÓI KÁRTYA
MT	KARTA TAS-SEWIEQ	KARTA TAL-KONTROLL	KARTA TAL-ISTAZZJON TAT-TESTIJET	KARTA TAL-KUMPANNIJA
NL	BESTUURDERSKAART	CONTROLEKAART	WERKPLAATSKAART	BEROUPSKAART
PL	KARTA KIEROWCY	KARTA KONTROLNA	KARTA WARSZTATOWA	KARTA PRZEDSIĘBIORSTWA
PT	CARTÃO DE CONDUTOR	CARTÃO DE CONTROLO	CARTÃO DO CENTRO DE ENSAIO	CARTÃO DE EMPRESA
RO	CARTELA CONDUCĂTOR AUTO	CARTELA DE CONTROL	CARTELA AGENTULUI ECONOMIC AUTORIZAT	CARTELA OPERATORULUI DE TRANSPORT
SK	KARTA VODIČA	KONTROLNÁ KARTA	DIELENSKÁ KARTA	PODNIKOVÁ KARTA
SL	VOZNIKOVA KARTICA	KONTROLNA KARTICA	KARTICA PREIZKUŠEVALNIŠČA	KARTICA PISARJA
FI	KULJETTAJAKORTI	YDONTAKORTI	JAAMOKORTI	YISKORTTI
SV	FÖRARKORT	KONTROLLKORT	VERKSTADSKORT	FÖRETAGSKORT]]

the name of the Member State issuing the card (optional);

[<sup>F20</sup>[<sup>F21</sup>the distinguishing sign of the Member State issuing the card, printed in negative in a blue rectangle and encircled by 12 yellow stars; the distinguishing signs shall be as follows:

B : Belgium  
 BG : Bulgaria  
 CZ : The Czech Republic

*Changes to legislation: There are currently no known outstanding effects for the Council Regulation (EEC) No 3821/85. (See end of Document for details)*

DK	:	Denmark
D	:	Germany
EST	:	Estonia
GR	:	Greece
E	:	Spain
F	:	France
HR	:	Croatia
IRL	:	Ireland
I	:	Italy
CY	:	Cyprus
LV	:	Latvia
LT	:	Lithuania
L	:	Luxembourg
H	:	Hungary
M	:	Malta
NL	:	The Netherlands
A	:	Austria
PL	:	Poland
P	:	Portugal
RO	:	Romania
SLO	:	Slovenia
SK	:	Slovakia
FIN	:	Finland
S	:	Sweden
UK	:	The United Kingdom.]]

information specific to the card issued, numbered as follows:

	<b>Driver card</b>	<b>Control card</b>	<b>Company or workshop card</b>
<b>1.</b>	Surname of the driver	Control body name	[ <sup>XI</sup> Company or workshop name]
<b>2.</b>	First name(s) of the driver	Surname of the controller (if applicable)	Surname of card holder (if applicable)
<b>3.</b>	Birth date of the driver	First name(s) of the controller (if applicable)	First name(s) of card holder (if applicable)
<b>4.(a)</b>	Card start of validity date		
<b>(b)</b>	Card expiry date (if any)		
<b>(c)</b>	The name of the issuing authority (may be printed on page 2)		
<b>(d)</b>	A different number from the one under heading 5, for administrative purposes (optional)		
<b>5.(a)</b>	Driving licence number (at the date of issue of the driver card)		
<b>5.(b)</b>	Card number		

**Changes to legislation:** There are currently no known outstanding effects for the Council Regulation (EEC) No 3821/85. (See end of Document for details)

6.	Photograph of the driver	Photograph of the controller (optional)	—
7.	Signature of the driver	Signature of the holder (optional)	
8.	Normal place of residence, or postal address of the holder (optional)	Postal address of control body	Postal address of company or workshop

dates shall be written using a 'dd/mm/yyyy' or 'dd.mm.yyyy' format (day, month, year);

#### Editorial Information

- X1** Substituted by [Corrigendum to Commission Regulation \(EC\) No 1360/2002 of 13 June 2002 adapting for the seventh time to technical progress Council Regulation \(EEC\) No 3821/85 on recording equipment in road transport \(Official Journal of the European Communities L 207 of 5 August 2002\)](#).

#### Textual Amendments

- F20** Substituted by [Council Regulation \(EC\) No 1791/2006 of 20 November 2006 adapting certain Regulations and Decisions in the fields of free movement of goods, freedom of movement of persons, company law, competition policy, agriculture \(including veterinary and phytosanitary legislation\), transport policy, taxation, statistics, energy, environment, cooperation in the fields of justice and home affairs, customs union, external relations, common foreign and security policy and institutions, by reason of the accession of Bulgaria and Romania](#).
- F21** Substituted by [Council Regulation \(EU\) No 517/2013 of 13 May 2013 adapting certain regulations and decisions in the fields of free movement of goods, freedom of movement for persons, company law, competition policy, agriculture, food safety, veterinary and phytosanitary policy, transport policy, energy, taxation, statistics, trans-European networks, judiciary and fundamental rights, justice, freedom and security, environment, customs union, external relations, foreign, security and defence policy and institutions, by reason of the accession of the Republic of Croatia](#).

the reverse page will contain:

an explanation of the numbered items which appear on the front page of the card;  
with the specific written agreement of the holder, information which is not related to the administration of the card may also be added, such addition will not alter in any way the use of the model as a tachograph card.

*Changes to legislation: There are currently no known outstanding effects for the Council Regulation (EEC) No 3821/85. (See end of Document for details)*

FRONT		REVERSE	
<b>DRIVER CARD</b>	<p><b>MEMBER STATE</b></p> <p>1. 2. 3. 4a. 4c. 5a. 5b. 7. (8.)</p>	<b>MEMBER STATE</b>	<p>1. Surname 2. First name(s) 3. Birth date</p> <p>4a. Date of start of validity of card</p> <p>4b. Administrative expiry date of card</p> <p>4c. Issuing authority</p> <p>(4d.) No for national administrative purposes</p> <p>5a. Driving license number 5b. Card number</p> <p>6. Photograph 7. Signature (8.) Address</p> <p>Please return to: <b>NAME OF AUTHORITY AND ADDRESS</b></p>
<b>CONTROL CARD</b>	<p><b>MEMBER STATE</b></p> <p>1. 2. 3. 4a. 4c. 5b. 7. 8.</p>	<b>MEMBER STATE</b>	<p>1. Control Body (2.) Surname (3.) First name(s)</p> <p>4a. Date of start of validity of card</p> <p>4b. Administrative expiry date of card</p> <p>4c. Issuing authority</p> <p>(4d.) No for national administrative purposes</p> <p>5b. Card number (6.) Photograph (7.) Signature 8. Address</p> <p>Please return to: <b>NAME OF AUTHORITY AND ADDRESS</b></p>
<b>WORKSHOP CARD</b>	<p><b>MEMBER STATE</b></p> <p>1. 2. 3. 4a. 4c. 5b. 7. 8.</p>	<b>MEMBER STATE</b>	<p>1. Workshop Name (2.) Surname (3.) First name(s)</p> <p>4a. Date of start of validity of card</p> <p>4b. Administrative expiry date of card</p> <p>4c. Issuing authority</p> <p>(4d.) No for national administrative purposes</p> <p>5b. Card number (7.) Signature 8. Address</p> <p>Please return to: <b>NAME OF AUTHORITY AND ADDRESS</b></p>
<b>COMPANY CARD</b>	<p><b>MEMBER STATE</b></p> <p>1. 2. 3. 4a. 4c. 5b. 7. 8.</p>	<b>MEMBER STATE</b>	<p>1. Company Name (2.) Surname (3.) First name(s)</p> <p>4a. Date of start of validity of card</p> <p>4b. Administrative expiry date of card</p> <p>4c. Issuing authority</p> <p>(4d.) No for national administrative purposes</p> <p>5b. Card number (7.) Signature 8. Address</p> <p>Please return to: <b>NAME OF AUTHORITY AND ADDRESS</b></p>

Tachograph cards shall be printed with the following background predominant colours:

- driver card: white,
- control card: blue,
- workshop card: red,
- company card: yellow.

Tachograph cards shall bear at least the following features for protection of the card body against counterfeiting and tampering:

- a security design background with fine guilloche patterns and rainbow printing,
- in the area of the photograph, the security design background and the photograph shall overlap,
- at least one two-coloured microprint line.



After consulting the Commission, Member States may add colours or markings, such as national symbols and security features, without prejudice to the other provisions of this Annex.

## 2. Security

The system security aims at protecting integrity and authenticity of data exchanged between the cards and the recording equipment, protecting the integrity and authenticity of data downloaded from the cards, allowing certain write operations onto the cards to recording equipment only, ruling out any possibility of falsification of data stored in the cards, preventing tampering and detecting any attempt of that kind.

In order to achieve the system security, the tachograph cards shall meet the security requirements defined in the tachograph cards generic security target (Appendix 10).

Tachograph cards shall be readable by other equipment such as personal computers.

## 3. Standards

The tachograph cards shall comply with the following standards:

- ISO/IEC 7810 Identification cards — Physical characteristics,
- ISO/IEC 7816 Identification cards — Integrated circuits with contacts:
  - Part 1: Physical characteristics,
  - Part 2: Dimensions and location of the contacts,
  - Part 3: Electronic signals and transmission protocols,
  - Part 4: Inter-industry commands for interchange,
  - Part 8: Security related inter-industry commands,
- ISO/IEC 10373 Identification cards — Test methods.

## 4. Environmental and electrical specifications

The tachograph cards shall be capable of operating correctly in all the climatic conditions normally encountered in Community territory and at least in the temperature range - 25 °C to + 70 °C with occasional peaks of up to + 85 °C, ‘occasional’ meaning not more than 4 hours each time and not over 100 times during the lifetime of the card.

The tachograph cards shall be capable of operating correctly in the humidity range 10 % to 90 %.

The tachograph cards shall be capable of operating correctly for a five-year period if used within the environmental and electrical specifications.

During operation, the tachograph cards shall conform to Commission Directive 95/54/EC of 31 October 1995<sup>(21)</sup>, related to electromagnetic compatibility, and shall be protected against electrostatic discharges.

## 5. Data storage

For the purpose of this paragraph,

- times are recorded with a resolution of one minute, unless otherwise specified,
- odometer values are recorded with a resolution of one kilometre,
- speeds are recorded with a resolution of 1 km/h.

The tachograph cards functions, commands and logical structures, fulfilling data storage requirements are specified in Appendix 2.

---

*Changes to legislation: There are currently no known outstanding effects for the Council Regulation (EEC) No 3821/85. (See end of Document for details)*

---

This paragraph specifies minimum storage capacity for the various application data files. The tachograph cards shall be able to indicate to the recording equipment the actual storage capacity of these data files.

Any additional data that may be stored on tachograph cards, related to other applications eventually borne by the card, shall be stored in accordance with Directive 95/46/EC of 24 October 1995 on the protection of individuals with regard to the processing of personal data and on the free movement of such data<sup>(22)</sup>.

#### 5.1. Card identification and security data

##### 5.1.1. Application identification

The tachograph cards shall be able to store the following application identification data:

- tachograph application identification,
- type of tachograph card identification.

##### 5.1.2. Chip identification

The tachograph cards shall be able to store the following integrated circuit (IC) identification data:

- IC serial number,
- IC manufacturing references.

##### 5.1.3. IC card identification

The tachograph cards shall be able to store the following smart card identification data:

- card serial number (including manufacturing references),
- card type approval number,
- card personaliser identification (ID),
- embedder ID,
- IC identifier.

##### 5.1.4. Security elements

The tachograph cards shall be able to store the following security elements data:

- European public key,
- Member State certificate,
- card certificate,
- card private key.

#### 5.2. Driver card

##### 5.2.1. Card identification

The driver card shall be able to store the following card identification data:

- card number,
- issuing Member State, issuing authority name, issue date,
- card beginning of validity date, card expiry date.

##### 5.2.2. Card holder identification

The driver card shall be able to store the following card holder identification data:

- surname of the holder,
- first name(s) of the holder,

---

*Changes to legislation: There are currently no known outstanding effects for the Council Regulation (EEC) No 3821/85. (See end of Document for details)*

---

- date of birth,
- preferred language.

### 5.2.3. Driving licence information

The driver card shall be able to store the following driving licence data:

- issuing Member State, issuing authority name,
- driving licence number (at the date of the issue of the card).

### 5.2.4. Vehicles used data

The driver card shall be able to store, for each calendar day where the card has been used, and for each period of use of a given vehicle that day (a period of use includes all consecutive insertion/withdrawal cycle of the card in the vehicle, as seen from the card point of view), the following data:

- date and time of first use of the vehicle (i.e. first card insertion for this period of use of the vehicle, or 00.00 if the period of use is on-going at that time),
- vehicle odometer value at that time,
- date and time of last use of the vehicle, (i.e. last card withdrawal for this period of use of the vehicle, or 23.59 if the period of use is on-going at that time),
- vehicle odometer value at that time,
- VRN and registering Member State of the vehicle.

The driver card shall be able to store at least 84 such records.

### 5.2.5. Driver activity data

The driver card shall be able to store, for each calendar day where the card has been used or for which the driver has entered activities manually, the following data:

- the date,
- a daily presence counter (increased by one for each of these calendar days),
- the total distance travelled by the driver during this day,
- a driver status at 00.00,
- whenever the driver has changed of activity, and/or has changed of driving status, and/or has inserted or withdrawn his card:
  - the driving status (CREW, SINGLE),
  - the slot (DRIVER, CO-DRIVER),
  - the card status (INSERTED, NOT INSERTED),
  - the activity (DRIVING, AVAILABILITY, WORK, BREAK/REST),
  - the time of the change.

The driver card memory shall be able to hold driver activity data for at least 28 days (the average activity of a driver is defined as 93 activity changes per day).

The data listed under requirements 197 and 199 shall be stored in a way allowing the retrieval of activities in the order of their occurrence, even in case of a time overlap situation.

### 5.2.6. Places where daily work periods start and/or end

The driver card shall be able to store the following data related to places where daily work periods begin and/or end, entered by the driver:

- the date and time of the entry (or the date/time related to the entry if the entry is made during the manual entry procedure),

---

*Changes to legislation: There are currently no known outstanding effects for the Council Regulation (EEC) No 3821/85. (See end of Document for details)*

---

- the type of entry (begin or end, condition of entry),
- the country and region entered,
- the vehicle odometer value.

The driver card memory shall be able to hold at least 42 pairs of such records.

#### 5.2.7. Events data

For the purpose of this subparagraph, time shall be stored with a resolution of one second.

The driver card shall be able to store data related to the following events detected by the recording equipment while the card was inserted:

- time overlap (where this card is the cause of the event),
- card insertion while driving (where this card is the subject of the event),
- last card session not correctly closed (where this card is the subject of the event),
- power supply interruption,
- motion data error,
- security breach attempts.

The driver card shall be able to store the following data for these events:

- event code,
- date and time of beginning of the event (or of card insertion if the event was on-going at that time),
- date and time of end of the event (or of card withdrawal if the event was on-going at that time),
- VRN and registering Member State of vehicle in which the event happened.

Note: For the ‘time overlap’ event:

- date and time of beginning of the event shall correspond to the date and time of the card withdrawal from the previous vehicle,
- date and time of end of the event shall correspond to the date and time of card insertion in current vehicle,
- vehicle data shall correspond to the current vehicle raising the event.

Note: For the ‘last card session not correctly closed’ event:

- date and time of beginning of event shall correspond to the card insertion date and time of the session not correctly closed,
- date and time of end of event shall correspond to the card insertion date and time of the session during which the event was detected (current session),
- vehicle data shall correspond to the vehicle in which the session was not correctly closed.

The driver card shall be able to store data for the six most recent events of each type (i.e. 36 events).

#### 5.2.8. Faults data

For the purpose of this subparagraph, time shall be recorded with a resolution of one second.

The driver card shall be able to store data related to the following faults detected by the recording equipment while the card was inserted:

- card fault (where this card is the subject of the event),
- recording equipment fault.

---

**Changes to legislation:** There are currently no known outstanding effects for the Council Regulation (EEC) No 3821/85. (See end of Document for details)

---

The driver card shall be able to store the following data for these faults:

- fault code,
- date and time of beginning of the fault (or of card insertion if the fault was on-going at that time),
- date and time of end of the fault (or of card withdrawal if the fault was on-going at that time),
- VRN and registering Member State of vehicle in which the fault happened.

The driver card shall be able to store data for the twelve most recent faults of each type (i.e. 24 faults).

#### 5.2.9. Control activity data

The driver card shall be able to store the following data related to control activities:

- date and time of the control,
- control card number and card issuing Member State,
- type of the control (displaying and/or printing and/or VU downloading and/or card downloading (see note)),
- period downloaded, in case of downloading,
- VRN and registering Member State of the vehicle in which the control happened.

Note: security requirements imply that card downloading will only be recorded if performed through a recording equipment.

The driver card shall be able to hold one such record.

#### 5.2.10. Card session data

The driver card shall be able to store data related to the vehicle which opened its current session:

- date and time the session was opened (i.e. card insertion) with a resolution of one second,
- VRN and registering Member State.

#### 5.2.11. Specific conditions data

The driver card shall be able to store the following data related to specific conditions entered while the card was inserted (whatever the slot):

- date and time of the entry,
- type of specific condition.

The driver card shall be able to hold 56 such records.

### 5.3. Workshop card

#### 5.3.1. Security elements

The workshop card shall be able to store a personal identification number (PIN code).

The workshop card shall be able to store the cryptographic keys needed for pairing motion sensors to vehicle units.

#### 5.3.2. Card identification

The workshop card shall be able to store the following card identification data:

- card number,
- issuing Member State, issuing authority name, issue date,

---

*Changes to legislation: There are currently no known outstanding effects for the Council Regulation (EEC) No 3821/85. (See end of Document for details)*

---

— card beginning of validity date, card expiry date.

#### 5.3.3. Card holder identification

The workshop card shall be able to store the following card holder identification data:

- workshop name,
- workshop address,
- surname of the holder,
- first name(s) of the holder,
- preferred language.

#### 5.3.4. Vehicles used data

The workshop card shall be able to store vehicles used data records in the same manner as a driver card.

The workshop card shall be able to store at least 4 such records.

#### 5.3.5. Driver activity data

The workshop card shall be able to store driver activity data in the same manner as a driver card.

The workshop card shall be able to hold driver activity data for at least one day of average driver activity.

#### 5.3.6. Daily work periods start and/or end data

The workshop card shall be able to store daily works period start and/or end data records in the same manner as a driver card.

The workshop card shall be able to hold at least three pairs of such records.

#### 5.3.7. Events and faults data

The workshop card shall be able to store events and faults data records in the same manner as a driver card.

The workshop card shall be able to store data for the three most recent events of each type (i.e. 18 events) and the six most recent faults of each type (i.e. 12 faults).

#### 5.3.8. Control activity data

The workshop card shall be able to store a control activity data record in the same manner as a driver card.

#### 5.3.9. Calibration and time adjustment data

The workshop card shall be able to hold records of calibrations and/or time adjustments performed while the card is inserted in a recording equipment.

Each calibration record shall be able to hold the following data:

- [F<sup>22</sup>purpose of calibration (activation, first installation, installation, periodic inspection)],
- vehicle identification,
- parameters updated or confirmed (w, k, l, tyre size, speed limiting device setting, odometer (new and old values), date and time (new and old values),
- recording equipment identification (VU part number, VU serial number, motion sensor serial number).

---

**Changes to legislation:** There are currently no known outstanding effects for the Council Regulation (EEC) No 3821/85. (See end of Document for details)

---

### Textual Amendments

- F22** Substituted by [Commission Regulation \(EC\) No 432/2004 of 5 March 2004](#) adapting for the eighth time to technical progress Council Regulation (EEC) No 3821/85 of 20 December 1985 on recording equipment in road transport (Text with EEA relevance).

The workshop card shall be able to store at least 88 such records.

The workshop card shall hold a counter indicating the total number of calibrations performed with the card.

The workshop card shall hold a counter indicating the number of calibrations performed since its last download.

#### 5.3.10. Specific conditions data

The workshop card shall be able to store data relevant to specific conditions in the same manner as the driver card. The workshop card shall be able to store two such records.

#### 5.4. Control card

##### 5.4.1. Card identification

The control card shall be able to store the following card identification data:

- card number,
- issuing Member State, issuing authority name, issue date,
- card beginning of validity date, card expiry date (if any).

##### 5.4.2. Card holder identification

The control card shall be able to store the following card holder identification data:

- control body name,
- control body address,
- surname of the holder,
- first name(s) of the holder,
- preferred language.

##### 5.4.3. Control activity data

The control card shall be able to store the following control activity data:

- date and time of the control,
- type of the control (displaying and/or printing and/or VU downloading and/or card downloading),
- period downloaded (if any),
- VRN and Member State registering authority of the controlled vehicle,
- card number and card issuing Member State of the driver card controlled.

The control card shall be able to hold at least 230 such records.

#### 5.5. Company card

##### 5.5.1. Card identification

The company card shall be able to store the following card identification data:

- card number,

---

*Changes to legislation: There are currently no known outstanding effects for the Council Regulation (EEC) No 3821/85. (See end of Document for details)*

---

- issuing Member State, issuing authority name, issue date,
- card beginning of validity date, card expiry date (if any).

#### 5.5.2. Card holder identification

The company card shall be able to store the following card holder identification data:

- company name,
- company address.

#### 5.5.3. Company activity data

The company card shall be able to store the following company activity data:

- date and time of the activity,
- type of the activity (VU locking in and/or out, and/or VU downloading and/or card downloading),
- period downloaded (if any),
- VRN and Member State registering authority of vehicle,
- card number and card issuing Member State (in case of card downloading).

The company card shall be able to hold at least 230 such records.

## V. INSTALLATION OF RECORDING EQUIPMENT

### 1. Installation

New recording equipment shall be delivered non-activated to fitters or vehicle manufacturers, with all calibration parameters, as listed in Chapter III(20), set to appropriate and valid default values. Where no particular value is appropriate, literal parameters shall be set to strings of '?' and numeric parameters shall be set to '0'. <sup>[F18]</sup>Delivery of security relevant parts of the recording equipment can be restricted if required during security certification.]

Before its activation, the recording equipment shall give access to the calibration function even if not in calibration mode.

Before its activation, the recording equipment shall neither record nor store data referred by points III.12.3. to III.12.9. and III.12.12 to III.12.14. inclusive.

During installation, vehicle manufacturers shall pre-set all known parameters.

<sup>[F15]</sup>Vehicle manufacturers or fitters shall activate the installed recording equipment at the latest before the vehicle is used in scope of Regulation (EC) No. 561/2006.]

The activation of the recording equipment shall be triggered automatically by the first insertion of a workshop card in either of its card interface devices.

Specific pairing operations required between the motion sensor and the vehicle unit, if any, shall take place automatically before or during activation.

After its activation, the recording equipment shall fully enforce functions and data access rights.

The recording and storing functions of the recording equipment shall be fully operational after its activation.

<sup>[F15]</sup>Installation shall be followed by a calibration. The first calibration may not necessarily include entry of the vehicle registration number (VRN), when it is not known by the approved workshop having to undertake this calibration. In these circumstances, it shall be possible, for the vehicle owner, and at this time only, to enter the VRN using his Company Card prior to



---

*Changes to legislation: There are currently no known outstanding effects for the Council Regulation (EEC) No 3821/85. (See end of Document for details)*

---

using the vehicle in scope of Regulation (EC) No. 561/2006 (e.g by using commands through an appropriate menu structure of the vehicle unit's man-machine interface.)<sup>(23)</sup>. Any update or confirmation of this entry shall only be possible using a Workshop Card.]

The recording equipment must be positioned in the vehicle in such a way as to allow the driver to access the necessary functions from his seat.

## 2. Installation plaque

[<sup>F15</sup>After the recording equipment has been checked on installation, an installation plaque which is clearly visible and easily accessible shall be affixed onto the recording equipment. In cases where this is not possible, the plaque shall be affixed to the vehicle's 'B' pillar so that it is clearly visible. For vehicles that do not have a 'B' pillar, the installation plaque should be affixed to the doorframe on the driver's side of the vehicle and be clearly visible in all cases. After every inspection by an approved fitter or workshop, a new plaque shall be affixed in place of the previous one.]

[<sup>F23</sup>The plaque shall bear at least the following details:

### Textual Amendments

**F23** Substituted by [Commission Regulation \(EC\) No 68/2009 of 23 January 2009 adapting for the ninth time to technical progress Council Regulation \(EEC\) No 3821/85 on recording equipment in road transport \(Text with EEA relevance\)](#).

- name, address or trade name of the approved fitter or workshop,
- characteristic coefficient of the vehicle, in the form 'w = ... imp/km',
- constant of the recording equipment, in the form 'k = ... imp/km',
- effective circumference of the wheel tyres in the form 'l = ... mm',
- tyre size,
- [<sup>F15</sup>the date on which the characteristic coefficient of the vehicle and the effective circumference of the wheel tyres were measured,]
- the vehicle identification number,
- the part of the vehicle where the adaptor, if any, is installed,
- the part of the vehicle where the motion sensor is installed, if not connected to the gear-box or an adaptor is not being used,
- a description of the colour of the cable between the adaptor and that part of the vehicle providing its incoming impulses,
- the serial number of the embedded motion sensor of the adaptor.]

[<sup>F15</sup>For M1 and N1 vehicles only, and which are fitted with an adaptor in conformity with Regulation (EC) No. 68/2009<sup>(24)</sup>, and where it is not possible to include all the information necessary, as described in Requirement 250, a second, additional, plaque may be used. In such cases, this additional plaque shall contain at least the last four indents described in Requirement 250. This second, additional plaque, if used, shall be affixed next to or beside the first primary plaque described in Requirement 250, and shall have the same protection level. Furthermore the secondary plaque shall also bear the name, address or trade name of the approved fitter or workshop that carried out the installation, and the date of installation.]

## 3. Sealing

The following part shall be sealed:

---

*Changes to legislation: There are currently no known outstanding effects for the Council Regulation (EEC) No 3821/85. (See end of Document for details)*

---

- any connection which, if disconnected, would cause undetectable alterations to be made or undetectable data loss,
- the installation plaque, unless it is attached in such a way that it cannot be removed without the markings thereon being destroyed.

The seals mentioned above may be removed:

- in case of emergency,
- to install, to adjust or to repair a speed limitation device or any other device contributing to road safety, provided that the recording equipment continues to function reliably and correctly and is resealed by an approved fitter or workshop (in accordance with Chapter VI) immediately after fitting the speed limitation device or any other device contributing to road safety or within seven days in other cases.

On each occasion that these seals are broken a written statement giving the reasons for such action shall be prepared and made available to the competent authority.

## VI. CHECKS, INSPECTIONS AND REPAIRS

Requirements on the circumstances in which seals may be removed, as referred to in Article 12.5 of Regulation (EEC) No 3821/85 as last amended by Regulation (EC) No 2135/98, are defined in Chapter V(3) of this annex.

### 1. Approval of fitters or workshops

The Member States will approve, regularly control and certify the bodies to carry out:

- installations,
- checks,
- inspections,
- repairs.

In the framework of Article 12(1) of this Regulation, workshop cards will be issued only to fitters and/or workshops approved for the activation and/or the calibration of recording equipment in conformity with this annex and, unless duly justified:

- who are not eligible for a company card,
- and whose other professional activities do not present a potential compromise of the overall security of the system as defined in Appendix 10.

### 2. Check of new or repaired instruments

Every individual device, whether new or repaired, shall be checked in respect of its proper operation and the accuracy of its reading and recordings, within the limits laid down in Chapter III.2.1. and III.2.2 by means of sealing in accordance with Chapter V.3. and calibration.

### 3. Installation inspection

When being fitted to a vehicle, the whole installation (including the recording equipment) shall comply with the provisions relating to maximum tolerances laid down in Chapter III.2.1 and III.2.2.

### 4. Periodic inspections

Periodic inspections of the equipment fitted to the vehicles shall take place after any repair of the equipment, or after any alteration of the characteristic coefficient of the vehicle or of the effective circumference of the tyres, or after equipment UTC time is wrong by more than 20 minutes, or when the VRN has changed, and at least once within two years (24 months) of the last inspection.

---

*Changes to legislation: There are currently no known outstanding effects for the Council Regulation (EEC) No 3821/85. (See end of Document for details)*

---

These inspections shall include the following checks:

- that the recording equipment is working properly, including the data storage in tachograph cards function,
- that compliance with the provisions of Chapter III.2.1 and III.2.2 on the maximum tolerances on installation is ensured,
- that the recording equipment carries the type approval mark,
- [<sup>F15</sup>that the installation plaque, as defined by Requirement 250, and the descriptive plaque, as defined by Requirement 169, are affixed,]
- that the seals on the equipment and on the other parts of the installation are intact,
- the tyre size and the actual circumference of the wheel tyres,
- [<sup>F18</sup>that there are no manipulation devices attached to the equipment.]

[<sup>F18</sup>If one of the events listed in Chapter III Section 9 (Detection of Events and/or Faults) is found to have occurred since the last inspection and is considered by tachograph manufacturers and/or national authorities as potentially putting the security of the equipment at risk, the workshop shall:

- (a) make a comparison between the motion sensor identification data of the motion sensor plugged into the gearbox with that of the paired motion sensor registered in the vehicle unit;
- (b) check if the information recorded on the installation plaque matches with the information contained within the vehicle unit record;
- (c) by checking if the motion sensor serial number and approval number, if printed on the body of the motion sensor, matches the information contained within the vehicle unit record.

Workshops shall keep traces in their inspection reports of any findings concerning broken seals or manipulations devices. These reports shall be kept by workshops for at least two years and made available to the Competent Authority whenever requested to do so.]

These inspections shall include a calibration.

#### 5. Measurement of errors

The measurement of errors on installation and during use shall be carried out under the following conditions, which are to be regarded as constituting standard test conditions:

- vehicle unladen, in normal running order,
- tyre pressures in accordance with the manufacturer's instructions,
- tyre wear, within the limits allowed by national law,
- vehicle movement:
  - the vehicle shall advance under its own engine power in a straight line on level ground and at a speed of  $50 \pm 5$  km/h. The measuring distance shall be at least 1 000 m,
- provided that it is of comparable accuracy, alternative methods, such as a suitable test bench, may also be used for the test.

#### 6. Repairs

Workshops shall be able to download data from the recording equipment to give the data back to the appropriate transport company.

---

*Changes to legislation: There are currently no known outstanding effects for the Council Regulation (EEC) No 3821/85. (See end of Document for details)*

---

Approved workshops shall issue to transport companies a certificate of data un-downloadability where the malfunction of the recording equipment prevents previously recorded data to be downloaded, even after repair by this workshop. The workshops will keep a copy of each issued certificate for at least one year.

## VII. CARD ISSUING

The card issuing processes set-up by the Member States shall conform to the following:

The card number of the first issue of a tachograph card to an applicant shall have a consecutive index (if applicable) and a replacement index and a renewal index set to '0'.

The card numbers of all non-personal tachograph cards issued to a single control body or a single workshop or a single transport company shall have the same first 13 digits, and shall all have a different consecutive index.

A tachograph card issued in replacement of an existing tachograph card shall have the same card number as the replaced one except the replacement index which shall be raised by '1' (in the order 0, ..., 9, A, ..., Z).

A tachograph card issued in replacement of an existing tachograph card shall have the same card expiry date as the replaced one.

A tachograph card issued in renewal of an existing tachograph card shall have the same card number as the renewed one except the replacement index which shall be reset to '0' and the renewal index which shall be raised by '1' (in the order 0, ..., 9, A, ..., Z).

The exchange of an existing tachograph card, in order to modify administrative data, shall follow the rules of the renewal if within the same Member State, or the rules of a first issue if performed by another Member State.

The 'card holder surname' for non-personal workshop or control cards shall be filled with workshop or control body name.

[<sup>F18</sup>Member States shall exchange data electronically in order to ensure the uniqueness of the tachograph Driver Card that they issue. The competent authorities of Member States may also exchange data electronically when carrying out checks of driver cards at the roadside or at company premises in order to verify the uniqueness and status of the cards.]

## VIII. TYPE APPROVAL OF RECORDING EQUIPMENT AND TACHOGRAPH CARDS

### 1. General points

For the purpose of this chapter, the words 'recording equipment' mean 'recording equipment or its components'. No type approval is required for the cable(s) linking the motion sensor to the VU. The paper, for use by the recording equipment, shall be considered as a component of the recording equipment. [<sup>F18</sup>Any vehicle unit manufacturer may ask for type approval of its component with any type of motion sensor, and vice versa, provided each component complies with Requirement 001a.]

Recording equipment shall be submitted for approval complete with any integrated additional devices.

Type approval of recording equipment and of tachograph cards shall include security related tests, functional tests and interoperability tests. Positive results to each of these tests are stated by an appropriate certificate.

Member States type approval authorities will not grant a type approval certificate in accordance with Article 5 of this Regulation, as long as they do not hold:

---

*Changes to legislation: There are currently no known outstanding effects for the Council Regulation (EEC) No 3821/85. (See end of Document for details)*

---

- a security certificate,
- a functional certificate,
- and an interoperability certificate,

for the recording equipment or the tachograph card, subject of the request for type approval.

Any modification in software or hardware of the equipment or in the nature of materials used for its manufacture shall, before being used, be notified to the authority which granted type-approval for the equipment. This authority shall confirm to the manufacturer the extension of the type approval, or may require an update or a confirmation of the relevant functional, security and/or interoperability certificates.

Procedures to upgrade *in situ* recording equipment software shall be approved by the authority which granted type approval for the recording equipment. Software upgrade must not alter nor delete any driver activity data stored in the recording equipment. Software may be upgraded only under the responsibility of the equipment manufacturer.

## 2. Security certificate

The security certificate is delivered in accordance with the provisions of Appendix 10 to this Annex.

[<sup>F18</sup>In the exceptional circumstance that the security certification authorities refuse to certify new equipment on the grounds of obsolescence of the security mechanisms, type approval shall continue to be granted only in this specific and exceptional circumstance, and when no alternative solution, compliant with the Regulation, exists.]

In this circumstance the Member State concerned shall, without delay, inform the European Commission, which shall, within twelve calendar months of the grant of type approval, launch a procedure to ensure that the level of security is restored to its original levels.]

## 3. Functional certificate

Each candidate for type approval shall provide the Member State's type approval authority with all the material and documentation that the authority deems necessary.

[<sup>F18</sup>Manufacturers shall provide the relevant samples of type approved products and associated documentation required by laboratories appointed to perform functional tests, and within one month of the request being made. Any costs resulting from this request shall be borne by the requesting entity. Laboratories shall treat all commercially sensitive information in confidence.]

A functional certificate shall be delivered to the manufacturer only after all functional tests specified in Appendix 9, at least, have been successfully passed.

The type approval authority delivers the functional certificate. This certificate shall indicate, in addition to the name of its beneficiary and the identification of the model, a detailed list of the tests performed and the results obtained.

[<sup>F18</sup>The functional certificate of any recording equipment component shall also indicate the type approval numbers of all other type approved compatible recording equipment components.]

## 4. Interoperability certificate

Interoperability tests are carried out by a single laboratory under the authority and responsibility of the European Commission.

---

*Changes to legislation: There are currently no known outstanding effects for the Council Regulation (EEC) No 3821/85. (See end of Document for details)*

---

The laboratory shall register interoperability test requests introduced by manufacturers in the chronological order of their arrival.

Requests will be officially registered only when the laboratory is in possession of:

- the entire set of material and documents necessary for such interoperability tests,
- the corresponding security certificate,
- the corresponding functional certificate,

The date of the registration of the request shall be notified to the manufacturer.

[<sup>F15</sup>No interoperability tests shall be carried out by the laboratory for recording equipment or tachograph cards that have not been granted a security certificate and a functionality certificate, except in the exceptional circumstances described in Requirement 274a.]

Any manufacturer requesting interoperability tests shall commit to leave to the laboratory in charge of these tests the entire set of material and documents which he provided to carry out the tests.

The interoperability tests shall be carried out, in accordance with the provisions of paragraph 5 of Appendix 9 of this Annex, with respectively all the types of recording equipment or tachograph cards:

- for which type approval is still valid, or
- for which type approval is pending and that have a valid interoperability certificate.

The interoperability certificate shall be delivered by the laboratory to the manufacturer only after all required interoperability tests have been successfully passed.

If the interoperability tests are not successful with one or more of the recording equipment or tachograph card(s), as requested by requirement 283, the interoperability certificate shall not be delivered, until the requesting manufacturer has realised the necessary modifications and has succeeded with the interoperability tests. The laboratory shall identify the cause of the problem with the help of the manufacturers concerned by this interoperability fault and shall attempt to help the requesting manufacturer in finding a technical solution. In the case where the manufacturer has modified its product, it is the manufacturer's responsibility to ascertain from the relevant authorities that the security certificate and the functional certificates are still valid.

The interoperability certificate is valid for six months. It is revoked at the end of this period if the manufacturer has not received a corresponding type approval certificate. It is forwarded by the manufacturer to the type approval authority of the Member State who has delivered the functional certificate.

Any element that could be at the origin of an interoperability fault shall not be used for profit or to lead to a dominant position.

#### 5. Type approval certificate

The type approval authority of the Member State may deliver the type approval certificate as soon as it holds the three required certificates.

The type approval certificate shall be copied by the type approval authority to the laboratory in charge of the interoperability tests at the time of deliverance to the manufacturer.

The laboratory competent for interoperability tests shall run a public web site on which will be updated the list of recording equipment or tachograph cards models:

- for which a request for interoperability tests have been registered,
- having received an interoperability certificate (even provisional),

---

**Changes to legislation:** There are currently no known outstanding effects for the Council Regulation (EEC) No 3821/85. (See end of Document for details)

---

— having received a type approval certificate.

6. Exceptional procedure: first interoperability certificates

Until four months after a first couple of recording equipment and tachograph cards (driver, workshop, control and company cards) have been certified to be interoperable, any interoperability certificate delivered (including this very first one), regarding requests registered during this period, shall be considered provisional.

If at the end of this period, all products concerned are mutually interoperable, all corresponding interoperability certificates shall become definitive.

If during this period, interoperability faults are found, the laboratory in charge of interoperability tests shall identify the causes of the problems with the help of all manufacturers involved and shall invite them to realise the necessary modifications.

If at the end of this period, interoperability problems still remain, the laboratory in charge of interoperability tests, with the collaboration of the manufacturers concerned and with the type approval authorities who delivered the corresponding functional certificates shall find out the causes of the interoperability faults and establish which modifications should be made by each of the manufacturers concerned. The search for technical solutions shall last for a maximum of two months, after which, if no common solution is found, the Commission, after having consulted the laboratory in charge of interoperability tests, shall decide which equipment(s) and cards get a definitive interoperability certificate and state the reasons why.

Any request for interoperability tests, registered by the laboratory between the end of the four-month period after the first provisional interoperability certificate has been delivered and the date of the decision by the Commission referred to in requirement 294, shall be postponed until the initial interoperability problems have been solved. Those requests are then processed in the chronological order of their registration.

---

*Changes to legislation: There are currently no known outstanding effects for the Council Regulation (EEC) No 3821/85. (See end of Document for details)*

---

## Appendix 1

### DATA DICTIONARY

#### 1. INTRODUCTION

This appendix specifies data formats, data elements, and data structures for use within the recording equipment and tachograph cards.

##### 1.1. Approach for definitions of data types

This appendix uses Abstract Syntax Notation One (ASN.1) to define data types. This enables simple and structured data to be defined without implying any specific transfer syntax (encoding rules) which will be application and environment dependent.

ASN.1 type naming conventions are done in accordance with ISO/IEC 8824-1. This implies that:

- where possible, the meaning of the data type is implied through the names being selected,
- where a data type is a composition of other data types, the data type name is still a single sequence of alphabetical characters commencing with a capital letter, however capitals are used within the name to impart the corresponding meaning,
- in general, the data types names are related to the name of the data types from which they are constructed, the equipment in which data is stored and the function related to the data.

If an ASN.1 type is already defined as part of another standard and if it is relevant for usage in the recording equipment, then this ASN.1 type will be defined in this appendix.

To enable several types of encoding rules, some ASN.1 types in this appendix are constrained by value range identifiers. The value range identifiers are defined in paragraph 3.

##### 1.2. References

The following references are used in this Appendix:

ISO 639	Code for the representation of names of languages. First Edition: 1988
EN 726-3	Identification cards systems — Telecommunications integrated circuit(s) cards and terminals — Part 3: Application independent card requirements. December 1994
ISO 3779	Road vehicles — Vehicle identification number (VIN) — Content and structure. Edition 3: 1983
ISO/IEC 7816-5	Information technology — Identification cards — Integrated circuit(s) cards with contacts — Part 5: Numbering system and registration procedure for application identifiers. First edition: 1994 + Amendment 1: 1996
ISO/IEC 8824-1	Information technology — Abstract Syntax Notation 1 (ASN.1): Specification of basic notation. Edition 2: 1998
ISO/IEC 8825-2	Information technology — ASN.1 encoding rules: Specification of Packed Encoding Rules (PER). Edition 2: 1998
ISO/IEC 8859-1	Information technology — 8 bit single-byte coded graphic character sets — Part 1: Latin alphabet No 1. First edition: 1998
ISO/IEC 8859-7	Information technology — 8 bit single-byte coded graphic character sets — Part 7: Latin/Greek alphabet. First edition: 1987



**Changes to legislation:** There are currently no known outstanding effects for the Council Regulation (EEC) No 3821/85. (See end of Document for details)

ISO 16844-3 Road vehicles — Tachograph systems — Motion Sensor Interface. WD 3-20/05/99.

## 2. DATA TYPE DEFINITIONS

For any of the following data types, the default value for an 'unknown' or a 'not applicable' content will consist in filling the data element with 'FF'-Bytes.

### 2.1. ActivityChangeInfo

This data type enables to code, within a two bytes word, a slot status at 00.00 and/or a driver status at 00.00 and/or changes of activity and/or changes of driving status and/or changes of card status for a driver or a co-driver. This data type is related to requirements 084, 109a, 199 and 219.

*ActivityChangeInfo ::= OCTET STRING (SIZE(2))*

**Value assignment — Octet Aligned:** 's'p'aa'tttttttt'B (16 bits)

For Data Memory recordings (or slot status):

's'B	Slot:	'0'B: DRIVER, '1'B: CO-DRIVER,
'c'B	Driving status:	'0'B: SINGLE, '1'B: CREW,
'p'B	Driver (or workshop) card status in the relevant slot:	'0'B: INSERTED, a card is inserted, '1'B: NOT INSERTED, no card is inserted (or a card is withdrawn),
'aa'B	Activity:	'00'B: BREAK/REST, '01'B: AVAILABILITY, '10'B: WORK, '11'B: DRIVING,
'ttttttttt' 'B	Time of the change: Number of minutes since 00h00 on the given day.	

For Driver (or Workshop) card recordings (and driver status):

's'B	Slot (not relevant when 'p' = 1 except note below):	'0'B: DRIVER, '1'B: 2. CO-DRIVER,
'c'B	<b>Driving status (case 'p' = 0) or</b>	<b>Following activity status (case 'p' = 1):</b>
	'0'B: SINGLE,	'0'B: UNKNOWN
	'1'B: CREW,	'1'B: KNOWN (= manually entered)
'p'B	Card status:	'0'B: INSERTED, the card is inserted in a recording equipment, '1'B: NOT INSERTED, the card is not inserted (or the card is withdrawn),

---

*Changes to legislation: There are currently no known outstanding effects for the Council Regulation (EEC) No 3821/85. (See end of Document for details)*

---

'aa'B	Activity (not relevant when 'p' = 1 and 'c' = 0 except note below): '00'B: BREAK/REST, '01'B: AVAILABILITY, '10'B: WORK, '11'B: DRIVING,
'ttttttttt 'B	Time of the change: Number of minutes since 00h00 on the given day.

Note for the case 'card withdrawal':

When the card is withdrawn:

- 's' is relevant and indicates the slot from which the card is withdrawn,
- 'c' must be set to 0,
- 'p' must be set to 1,
- 'aa' must code the current activity selected at that time,

As a result of a manual entry, the bits 'c' and 'aa' of the word (stored in a card) may be overwritten later to reflect the entry.

#### [<sup>F15</sup>2.2. Address

An address.

```
Address: = SEQUENCE {
codePage INTEGER (0..255),
address OCTET STRING (SIZE(35))
}
```

**codePage** specifies a character set defined in Chapter 4,

**address** is an address encoded using the specified character set.]

#### 2.3. BCDString

BCDString is applied for Binary Code Decimal (BCD) representation. This data type is used to represent one decimal digit in one semi octet (4 bits). BCDString is based on the ISO/IEC 8824-1 'CharacterStringType'.

```
BCDString ::= CHARACTER STRING (WITH COMPONENTS {
identification ( WITH COMPONENTS {
fixed PRESENT }) })
```

BCDString uses an 'hstring' notation. The leftmost hexadecimal digit shall be the most significant semi octet of the first octet. To produce a multiple of octets, zero trailing semi octets shall be inserted, as needed, from the leftmost semi octet position in the first octet.

Permitted digits are: 0, 1, ... 9.

#### 2.4. CalibrationPurpose

Code explaining why a set of calibration parameters was recorded. This data type is related to requirements 097 and 098.

**Changes to legislation:** There are currently no known outstanding effects for the Council Regulation (EEC) No 3821/85. (See end of Document for details)

*CalibrationPurpose ::= OCTET STRING (SIZE(1)).*

**Value assignment:**

'00'H	reserved value,
'01'H	activation: recording of calibration parameters known, at the moment of the VU activation,
'02'H	first installation: first calibration of the VU after its activation,
'03'H	installation: first calibration of the VU in the current vehicle,
'04'H	periodic inspection.

2.5. CardActivityDailyRecord

Information, stored in a card, related to the driver activities for a particular calendar day. This data type is related to requirements 199 and 219.

*CardActivityDailyRecord ::= SEQUENCE {*

*activityPreviousRecordLength INTEGER(0..CardActivityLengthRange),*

*[<sup>X2</sup> activityRecordLength INTEGER (0.. CardActivityLengthRange) ]*

**Editorial Information**

**X2** Inserted by [Corrigendum to Commission Regulation \(EC\) No 1360/2002 of 13 June 2002 adapting for the seventh time to technical progress Council Regulation \(EEC\) No 3821/85 on recording equipment in road transport \(Official Journal of the European Communities L 207 of 5 August 2002\).](#)

*activityRecordDate TimeReal,*

*activityDailyPresenceCounter DailyPresenceCounter,*

*activityDayDistance Distance,*

*activityChangeInfo SET SIZE(1..1 440) OF ActivityChangeInfo*

*}*

**activityPreviousRecordLength** is the total length in bytes of the previous daily record. The maximum value is given by the length of the OCTET STRING containing these records (see CardActivityLengthRange paragraph 3). When this record is the oldest daily record, the value of activityPreviousRecordLength must be set to 0.

**activityRecordLength** is the total length in bytes of this record. The maximum value is given by the length of the OCTET STRING containing these records.

**activityRecordDate** is the date of the record.

**activityDailyPresenceCounter** is the daily presence counter for the card this day.

**activityDayDistance** is the total distance travelled this day.

**activityChangeInfo** is the set of ActivityChangeInfo data for the driver this day. It may contain at maximum 1 440 values (one activity change per minute). This set always includes the activityChangeInfo coding the driver status at 00.00.

2.6. CardActivityLengthRange

Number of bytes in a driver or a workshop card, available to store driver activity records.

---

*Changes to legislation: There are currently no known outstanding effects for the Council Regulation (EEC) No 3821/85. (See end of Document for details)*

---

*CardActivityLengthRange ::= INTEGER(0..2<sup>16</sup>-1)*

**Value assignment:** see paragraph 3.

#### 2.7. CardApprovalNumber

Type approval number of the card.

*CardApprovalNumber ::= IA5String(SIZE(8))*

**Value assignment:** Unspecified.

#### 2.8. CardCertificate

*Certificate of the public key of a card.*

*CardCertificate ::= Certificate.*

#### 2.9. CardChipIdentification

Information, stored in a card, related to the identification of the card's Integrated Circuit (IC) (requirement 191).

*CardChipIdentification ::= SEQUENCE {  
icSerialNumber OCTET STRING (SIZE(4)),  
icManufacturingReferences OCTET STRING (SIZE(4))  
}*

**icSerialNumber** is the IC serial number as defined in EN 726-3.

**icManufacturingReferences** is the IC manufacturer identifier and fabrication elements as defined in EN 726-3.

#### 2.10. CardConsecutiveIndex

A card consecutive index (definition h)).

*CardConsecutiveIndex ::= IA5String(SIZE(1))*

**Value assignment:** (see this Annex Chapter VII)

Order for increase : '0, ..., 9, A, ..., Z, a, ..., z'.

#### 2.11. CardControlActivityDataRecord

Information, stored in a driver or workshop card, related to the last control the driver has been subject to (requirements 210 and 225).

*CardControlActivityDataRecord ::= SEQUENCE {  
controlType controlType,  
controlTime TimeReal,  
controlCardNumber FullCardNumber,  
controlVehicleRegistration VehicleRegistrationIdentification,  
controlDownloadPeriodBegin TimeReal,*

*controlDownloadPeriodEnd TimeReal,*

}

**controlType** is the type of the control.

**controlTime** is the date and time of the control.

**controlCardNumber** is the FullCardNumber of the control officer having performed the control.

**controlVehicleRegistration** is the VRN and registering Member State of the vehicle in which the control happened.

**controlDownloadPeriodBegin** and **controlDownloadPeriodEnd** is the period downloaded, in case of downloading.

## 2.12. CardCurrentUse

Information about the actual usage of the card (requirement 212).

*CardCurrentUse ::= SEQUENCE {*

*sessionOpenTime TimeReal,*

*sessionOpenVehicle VehicleRegistrationIdentification*

}

**sessionOpenTime** is the time when the card is inserted for the current usage. This element is set to zero at card removal.

**sessionOpenVehicle** is the identification of the currently used vehicle, set at card insertion. This element is set to zero at card removal.

## 2.13. CardDriverActivity

Information, stored in a driver or a workshop card, related to the activities of the driver (requirements 199 and 219).

*CardDriverActivity ::= SEQUENCE {*

*activityPointerOldestDayRecord INTEGER(0..CardActivityLengthRange-1),*

*activityPointerNewestRecord INTEGER(0..CardActivityLengthRange-1),*

*activityDailyRecords OCTET STRING (SIZE(CardActivityLengthRange))*

}

**activityPointerOldestDayRecord** is the specification of the begin of the storage place (number of bytes from the beginning of the string) of the oldest complete day record in the activityDailyRecords string. The maximum value is given by the length of the string.

**activityPointerNewestRecord** is the specification of the begin of the storage place (number of bytes from the beginning of the string) of the most recent day record in the activityDailyRecords string. The maximum value is given by the length of the string.

**activityDailyRecords** is the space available to store the driver activity data (data structure: CardActivityDailyRecord) for each calendar day where the card has been used.

---

*Changes to legislation: There are currently no known outstanding effects for the Council Regulation (EEC) No 3821/85. (See end of Document for details)*

---

**Value assignment:** this octet string is cyclically filled with records of CardActivityDailyRecord. At the first use storing is started at the first byte of the string. All new records are appended at the end of the previous one. When the string is full, storing continues at the first byte of the string independently of a break being inside a data element. Before placing new activity data in the string (enlarging current activityDailyRecord, or placing a new activityDailyRecord) that replaces older activity data, activityPointerOldestDayRecord must be updated to reflect the new location of the oldest complete day record, and activityPreviousRecordLength of this (new) oldest complete day record must be reset to 0.

#### 2.14. CardDrivingLicenceInformation

Information, stored in a driver card, related to the card holder driver licence data (requirement 196).

```
CardDrivingLicenceInformation ::= SEQUENCE {
    drivingLicenceIssuingAuthority Name,
    drivingLicenceIssuingNation NationNumeric,
    drivingLicenceNumber IA5String(SIZE(16))
}
```

**drivingLicenceIssuingAuthority** is the authority responsible for issuing the driving licence.

**drivingLicenceIssuingNation** is the nationality of the authority that issued the driving licence.

**drivingLicenceNumber** is the number of the driving licence.

#### 2.15. CardEventData

Information, stored in a driver or workshop card, related to the events associated with the card holder (requirements 204 and 223).

```
CardEventData ::= SEQUENCE SIZE(6) OF {
    cardEventRecords SET SIZE(NumberOfEventsPerType) OF CardEventRecord
}
```

**CardEventData** is a sequence, ordered by ascending value of EventFaultType, of cardEventRecords (except security breach attempts related records which are gathered in the last set of the sequence).

**cardEventRecords** is a set of event records of a given event type (or category for security breach attempts events).

#### 2.16. CardEventRecord

Information, stored in a driver or a workshop card, related to an event associated to the card holder (requirements 205 and 223).

```
CardEventRecord ::= SEQUENCE {
    eventType EventFaultType,
    eventBeginTime TimeReal,
    eventEndTime TimeReal,
```

---

**Changes to legislation:** There are currently no known outstanding effects for the Council Regulation (EEC) No 3821/85. (See end of Document for details)

---

*eventVehicleRegistration VehicleRegistrationIdentification*

}

**eventType** is the type of the event.

**eventBeginTime** is the date and time of beginning of event.

**eventEndTime** is the date and time of end of event.

**eventVehicleRegistration** is the VRN and registering Member State of vehicle in which the event happened.

#### 2.17. CardFaultData

Information, stored in a driver or a workshop card, related to the faults associated to the card holder (requirements 207 and 223).

*CardFaultData ::= SEQUENCE SIZE(2) OF {*  
*cardFaultRecords SET SIZE(NoOfFaultsPerType) OF CardFaultRecord*  
*}*

**CardFaultData** is a sequence of Recording Equipment faults set of records followed by card faults set of records.

**cardFaultRecords** is a set of fault records of a given fault category (Recording Equipment or card).

#### 2.18. CardFaultRecord

Information, stored in a driver or a workshop card, related to a fault associated to the card holder (requirement 208 and 223).

*CardFaultRecord ::= SEQUENCE {*  
*faultType EventFaultType,*  
*faultBeginTime TimeReal,*  
*faultEndTime TimeReal,*  
*faultVehicleRegistration VehicleRegistrationIdentification*  
*}*

**faultType** is the type of the fault.

**faultBeginTime** is the date and time of beginning of fault.

**faultEndTime** is the date and time of end of fault.

**faultVehicleRegistration** is the VRN and registering Member State of vehicle in which the fault happened.

#### 2.19. CardIccIdentification

Information, stored in a card, related to the identification of the integrated circuit (IC) card (requirement 192).

*CardIccIdentification ::= SEQUENCE {*

---

*Changes to legislation: There are currently no known outstanding effects for the Council Regulation (EEC) No 3821/85. (See end of Document for details)*

---

```

clockStop OCTET STRING (SIZE(1)),
cardExtendedSerialNumber ExtendedSerialNumber,
cardApprovalNumber CardApprovalNumber
cardPersonaliserID OCTET STRING (SIZE(1)),
embedderIcAssemblerId OCTET STRING (SIZE(5)),
icIdentifier OCTET STRING (SIZE(2))
}

```

**clockStop** is the Clockstop mode as defined in EN 726-3.

**cardExtendedSerialNumber** is the IC card serial number and IC card manufacturing reference as defined in EN 726-3 and as further specified by the ExtendedSerialNumber data type.

**cardApprovalNumber** is the type approval number of the card.

**cardPersonaliserID** is the card personaliser ID as defined in EN 726-3.

**embedderIcAssemblerId** is the embedder/IC assembler identifier as defined in EN 726-3.

**icIdentifier** is the Identifier of the IC on the card and its IC manufacturer as defined in EN 726-3.

## 2.20. CardIdentification

Information, stored in a card, related to the identification of the card (requirements 194, 215, 231, 235).

*CardIdentification ::= SEQUENCE*

```

cardIssuingMemberState NationNumeric,
cardNumber CardNumber,
cardIssuingAuthorityName Name,
cardIssueDate TimeReal,
cardValidityBegin TimeReal,
cardExpiryDate TimeReal
}

```

**cardIssuingMemberState** is the code of the Member State issuing the card.

**cardNumber** is the card number of the card.

**cardIssuingAuthorityName** is the name of the authority having issued the Card.

**cardIssueDate** is the issue date of the Card to the current holder.

**cardValidityBegin** is the first date of validity of the card.

**cardExpiryDate** is the date when the validity of the card ends.

## 2.21. CardNumber

A card number as defined by definition g).



---

**Changes to legislation:** There are currently no known outstanding effects for the Council Regulation (EEC) No 3821/85. (See end of Document for details)

---

```

CardNumber ::= CHOICE {
SEQUENCE {
driverIdentification IA5String(SIZE(14)),
cardReplacementIndex CardReplacementIndex,
cardRenewalIndex CardRenewalIndex
}
SEQUENCE {
ownerIdentification IA5String(SIZE(13)),
cardConsecutiveIndex CardConsecutiveIndex,
cardReplacementIndex CardReplacementIndex,
cardRenewalIndex CardRenewalIndex
}
}

```

**driverIdentification** is the unique identification of a driver in a Member State.

**ownerIdentification** is the unique identification of a company or a workshop or a control body within a Member State.

**cardConsecutiveIndex** is the card consecutive index.

**cardReplacementIndex** is the card replacement index.

**cardRenewalIndex** is the card renewal index.

The first sequence of the choice is suitable to code a driver card number, the second sequence of the choice is suitable to code workshop, control, and company card numbers.

## 2.22. CardPlaceDailyWorkPeriod

Information, stored in a driver or a workshop card, related to the places where daily work periods begin and/or end (requirements 202 and 221).

```

CardPlaceDailyWorkPeriod ::= SEQUENCE {
    placePointerNewestRecord INTEGER(0..NoOfCardPlaceRecords-1),
    [X1 placeRecords          SET SIZE(NoOfCardPlaceRecords) OF PlaceRecord]
}

```

**placePointerNewestRecord** is the index of the last updated place record.

**Value assignment:** Number corresponding to the numerator of the place record, beginning with '0' for the first occurrence of the place records in the structure.

**placeRecords** is the set of records containing the information related to the places entered.

## 2.23. CardPrivateKey

The private key of a card.

---

*Changes to legislation: There are currently no known outstanding effects for the Council Regulation (EEC) No 3821/85. (See end of Document for details)*

---

CardPrivateKey ::= RSAKeyPrivateExponent.

#### 2.24. CardPublicKey

The public key of a card.

CardPublicKey ::= PublicKey.

#### 2.25. CardRenewalIndex

A card renewal index (definition i)).

CardRenewalIndex ::= IA5String(SIZE(1)).

**Value assignment:** (see this Annex Chapter VII).

'0'                      First issue.  
Order for increase:    '0, ..., 9, A, ..., Z'.

#### 2.26. CardReplacementIndex

A card replacement index (definition j)).

*CardReplacementIndex ::= IA5String(SIZE(1))*

**Value assignment:** (see this Annex Chapter VII).

'0'                      Original card.  
Order for increase:    '0, ..., 9, A, ..., Z'.

#### 2.27. CardSlotNumber

Code to distinguish between the two slots of a vehicle unit.

*CardSlotNumber ::= INTEGER {*  
*driverSlot (0),*  
*co-driverSlot (1)*  
*}*

**Value assignment:** not further specified.

#### 2.28. CardSlotsStatus

Code indicating the type of cards inserted in the two slots of the vehicle unit.

*CardSlotsStatus ::= OCTET STRING (SIZE(1))*

**Value assignment — Octet Aligned: 'ccccddd'B:**

'cccc'B                Identification of the type of card inserted in the co-driver slot,  
'ddd'd'B                Identification of the type of card inserted in the driver slot,

with the following identification codes:

'0000'B                no card is inserted,  
'0001'B                a driver card is inserted,  
'0010'B                a workshop card is inserted,  
'0011'B                a control card is inserted,  
'0100'B                a company card is inserted.

### 2.29. CardStructureVersion

Code indicating the version of the implemented structure in a tachograph card.

*CardStructureVersion ::= OCTET STRING (SIZE(2))*

**Value assignment: 'aabb'H:**

' <sup>F22</sup> aa'H	Index for changes of the structure, '00h' for this version
'bb'H	Index for changes concerning the use of the data elements defined for the structure given by the high byte, '00h' for this version.]

### 2.30. CardVehicleRecord

Information, stored in a driver or workshop card, related to a period of use of a vehicle during a calendar day (requirements 197 and 217).

*CardVehicleRecord ::= SEQUENCE {*  
*vehicleOdometerBegin OdometerShort,*  
*vehicleOdometerEnd OdometerShort,*  
*vehicleFirstUse TimeReal,*  
*vehicleLastUse TimeReal,*  
*vehicleRegistration VehicleRegistrationIdentification,*  
*vuDataBlockCounter VuDataBlockCounter*  
*}*

**vehicleOdometerBegin** is the vehicle odometer value at the beginning of the period of use of the vehicle.

**vehicleOdometerEnd** is the vehicle odometer value at the end of the period of use of the vehicle.

**vehicleFirstUse** is the date and time of the beginning of the period of use of the vehicle.

**vehicleLastUse** is the date and time of the end of the period of use of the vehicle.

**vehicleRegistration** is the VRN and the registering Member State of the vehicle.

**vuDataBlockCounter** is the value of the VuDataBlockCounter at last extraction of the period of use of the vehicle.

### 2.31. CardVehiclesUsed

Information, stored in a driver or workshop card, related to the vehicles used by the card holder (requirements 197 and 217).

*CardVehiclesUsed ::= SEQUENCE {*  
*vehiclePointerNewestRecord INTEGER(0..NoOfCardVehicleRecords-1),*  
*cardVehicleRecords SET SIZE(NoOfCardVehicleRecords) OF CardVehicleRecord*  
*}*

---

*Changes to legislation: There are currently no known outstanding effects for the Council Regulation (EEC) No 3821/85. (See end of Document for details)*

---

**vehiclePointerNewestRecord** is the index of the last updated vehicle record.

**Value assignment:** Number corresponding to the numerator of the vehicle record, beginning with '0' for the first occurrence of the vehicle records in the structure.

**cardVehicleRecords** is the set of records containing information on vehicles used.

### 2.32. Certificate

The certificate of a public key issued by a Certification Authority.

*Certificate ::= OCTET STRING (SIZE(194))*

**Value assignment:** digital signature with partial recovery of a CertificateContent according to Appendix 11 'common security mechanisms': Signature (128 bytes) Public Key remainder (58 Byte) Certification Authority Reference (8 bytes).

### 2.33. CertificateContent

The (clear) content of the certificate of a public key according to Appendix 11 common security mechanisms.

*CertificateContent ::= SEQUENCE {*  
*certificateProfileIdentifier INTEGER(0..255),*  
*certificationAuthorityReference KeyIdentifier,*  
*certificateHolderAuthorisation CertificateHolderAuthorisation,*  
*certificateEndOfValidity TimeReal,*  
*certificateHolderReference KeyIdentifier,*  
*publicKey PublicKey*  
*}*

**certificateProfileIdentifier** is the version of the corresponding certificate.

**Value assignment:** '01h' for this version.

**CertificationAuthorityReference** identifies the Certification Authority issuing the certificate. It also references the Public Key of this Certification Authority.

**certificateHolderAuthorisation** identifies the rights of the certificate holder.

**certificateEndOfValidity** is the date when the certificate expires administratively.

**certificateHolderReference** identifies the certificate holder. It also references his Public Key.

**publicKey** is the public key that is certified by this certificate.

### 2.34. CertificateHolderAuthorisation

Identification of the rights of a certificate holder.

*CertificateHolderAuthorisation ::= SEQUENCE {*  
*tachographApplicationID OCTET STRING(SIZE(6))*  
*equipmentType EquipmentType*

---

**Changes to legislation:** There are currently no known outstanding effects for the Council Regulation (EEC) No 3821/85. (See end of Document for details)

---

}

**tachographApplicationID** is the application identifier for the tachograph application.

**Value assignment:** 'FFh' '54h' '41h' '43h' '48h' '4Fh'. This AID is a proprietary non-registered application identifier in accordance with ISO/IEC 7816-5.

**equipmentType** is the identification of the type of equipment to which the certificate is intended.

**Value assignment:** in accordance with EquipmentType data type. 0 if certificate is the one of a Member State.

### 2.35. CertificateRequestID

Unique identification of a certificate request. It can also be used as a Vehicle Unit Public Key Identifier if the serial number of the vehicle Unit to which the key is intended is not known at certificate generation time.

```
CertificateRequestID ::= SEQUENCE {
    requestSerialNumber INTEGER(0..232-1)
    requestMonthYear BCDString(SIZE(2))
    crIdentifier OCTET STRING(SIZE(1))
    manufacturerCode ManufacturerCode
}
```

**requestSerialNumber** is a serial number for the certificate request, unique for the manufacturer and the month below.

**requestMonthYear** is the identification of the month and the year of the certificate request.

**Value assignment:** BCD coding of month (two digits) and year (two last digits).

**crIdentifier:** is an identifier to distinguish a certificate request from an extended serial number.

**Value assignment:** 'FFh'.

**manufacturerCode:** is the numerical code of the manufacturer requesting the certificate.

### 2.36. CertificationAuthorityKID

Identifier of the Public Key of a Certification Authority (a Member State or the European Certification Authority).

```
CertificationAuthorityKID ::= SEQUENCE {
    nationNumeric NationNumeric
    nationAlpha NationAlpha
    keySerialNumber INTEGER(0..255)
    additionalInfo OCTET STRING(SIZE(2))
    caIdentifier OCTET STRING(SIZE(1))
}
```

---

*Changes to legislation: There are currently no known outstanding effects for the Council Regulation (EEC) No 3821/85. (See end of Document for details)*

---

**nationNumeric** is the numerical nation code of the Certification Authority.

**nationAlpha** is the alphanumerical nation code of the Certification Authority.

**keySerialNumber** is a serial number to distinguish the different keys of the Certification Authority in the case keys are changed.

**additionalInfo** is a two byte field for additional coding (Certification Authority specific).

**caIdentifier** is an identifier to distinguish a Certification Authority Key Identifier from other Key Identifiers.

**Value assignment:** '01h'.

### 2.37. CompanyActivityData

Information, stored in a company card, related to activities performed with the card (requirement 237).

```

CompanyActivityData ::= SEQUENCE {
    companyPointerNewestRecord INTEGER(0..NoOfCompanyActivityRecords-1),
    companyActivityRecords SET SIZE(NoOfCompanyActivityRecords) OF
    companyActivityRecord SEQUENCE {
        companyActivityType CompanyActivityType,
        companyActivityTime TimeReal,
        cardNumberInformation FullCardNumber,
        vehicleRegistrationInformation VehicleRegistrationIdentification,
        downloadPeriodBegin TimeReal,
        downloadPeriodEnd TimeReal
    }
}

```

**companyPointerNewestRecord** is the index of the last updated companyActivityRecord.

**Value assignment:** Number corresponding to the numerator of the company activity record, beginning with '0' for the first occurrence of the company activity record in the structure.

**companyActivityRecords** is the set of all company activity records.

**companyActivityRecord** is the sequence of information related to one company activity.

**companyActivityType** is the type of the company activity.

**companyActivityTime** is the date and time of the company activity.

**cardNumberInformation** is the card number and the card issuing Member State of the card downloaded, if any.

**vehicleRegistrationInformation** is the VRN and registering Member State of the vehicle downloaded or locked in or out.

**downloadPeriodBegin** and **downloadPeriodEnd** is the period downloaded from the VU, if any.

#### 2.38. CompanyActivityType

Code indicating an activity carried out by a company using its company card.

*CompanyActivityType ::= INTEGER {*

*card downloading (1),*

*VU downloading (2),*

*VU lock-in (3),*

*VU lock-out (4)*

*}*

#### 2.39. CompanyCardApplicationIdentification

Information, stored in a company card related to the identification of the application of the card (requirement 190).

*CompanyCardApplicationIdentification ::= SEQUENCE {*

*typeOfTachographCardId EquipmentType,*

*cardStructureVersion CardStructureVersion,*

*noOfCompanyActivityRecords NoOfCompanyActivityRecords*

*}*

**typeOfTachographCardId** is specifying the implemented type of card.

**cardStructureVersion** is specifying the version of the structure that is implemented in the card.

**noOfCompanyActivityRecords** is the number of company activity records the card can store.

#### 2.40. CompanyCardHolderIdentification

Information, stored in a company card, related to the cardholder identification (requirement 236).

*CompanyCardHolderIdentification ::= SEQUENCE {*

*companyName Name,*

*companyAddress Address,*

*cardHolderPreferredLanguage Language*

*}*

**companyName** is the name of the holder company.

**companyAddress** is the address of the holder company.

**cardHolderPreferredLanguage** is the preferred language of the card holder.

#### 2.41. ControlCardApplicationIdentification

---

*Changes to legislation: There are currently no known outstanding effects for the Council Regulation (EEC) No 3821/85. (See end of Document for details)*

---

Information, stored in a control card related to the identification of the application of the card (requirement 190).

```
ControlCardApplicationIdentification ::= SEQUENCE {
  typeOfTachographCardId EquipmentType,
  cardStructureVersion CardStructureVersion,
  noOfControlActivityRecords NoOfControlActivityRecords
}
```

**typeOfTachographCardId** is specifying the implemented type of card.

**cardStructureVersion** is specifying the version of the structure that is implemented in the card.

**noOfControlActivityRecords** is the number of control activity records the card can store.

#### 2.42. ControlCardControlActivityData

Information, stored in a control card, related to control activity performed with the card (requirement 233).

```
ControlCardControlActivityData ::= SEQUENCE {
  controlPointerNewestRecord INTEGER(0..NoOfControlActivityRecords-1),
  controlActivityRecords SET SIZE(NoOfControlActivityRecords) OF
  controlActivityRecord SEQUENCE {
    controlType ControlType,
    controlTime TimeReal,
    controlledCardNumber FullCardNumber,
    controlledVehicleRegistration VehicleRegistrationIdentification,
    controlDownloadPeriodBegin TimeReal,
    controlDownloadPeriodEnd TimeReal
  }
}
```

**controlPointerNewestRecord** is the index of the last updated control activity record.

**Value assignment:** Number corresponding to the numerator of the control activity record, beginning with '0' for the first occurrence of the control activity record in the structure.

**controlActivityRecords** is the set of all control activity records.

**controlActivityRecord** is the sequence of information related to one control.

**controlType** is the type of the control.

**controlTime** is the date and time of the control.



**controlledCardNumber** is the card number and the card issuing Member State of the card controlled.

**controlledVehicleRegistration** is the VRN and registering Member State of the vehicle in which the control happened.

**controlDownloadPeriodBegin** and **controlDownloadPeriodEnd** is the period eventually downloaded.

#### 2.43. ControlCardHolderIdentification

Information, stored in a control card, related to the identification of the cardholder (requirement 232).

```
ControlCardHolderIdentification ::= SEQUENCE {
controlBodyName Name,
controlBodyAddress Address,
cardHolderName HolderName,
cardHolderPreferredLanguage Language
}
```

**controlBodyName** is the name of the control body of the card holder.

**controlBodyAddress** is the address of the control body of the card holder.

**cardHolderName** is the name and first name(s) of the holder of the Control Card.

**cardHolderPreferredLanguage** is the preferred language of the card holder.

#### 2.44. ControlType

Code indicating the activities carried out during a control. This data type is related to requirements 102, 210 and 225.

```
ControlType ::= OCTET STRING (SIZE(1))
```

**Value assignment** — **Octet aligned:**'c'p'd'xxxx'B (8 bits)

'c'B	card downloading: '0'B: card not downloaded during this control activity, '1'B: card downloaded during this control activity
'v'B	VU downloading: '0'B: VU not downloaded during this control activity, '1'B: VU downloaded during this control activity
'p'B	printing: '0'B: no printing done during this control activity, '1'B: printing done during this control activity
'd'B	display: '0'B: no display used during this control activity, '1'B: display used during this control activity
'xxxx'B	Not used.

#### 2.45. CurrentDateTime

---

*Changes to legislation: There are currently no known outstanding effects for the Council Regulation (EEC) No 3821/85. (See end of Document for details)*

---

The current date and time of the recording equipment.

*CurrentDateTime ::= TimeReal*

**Value assignment:** not further specified.

#### 2.46. DailyPresenceCounter

Counter, stored in a driver or workshop card, increased by one for each calendar day the card has been inserted in a VU. This data type is related to requirements 199 and 219.

*DailyPresenceCounter ::= BCDString(SIZE(2))*

**Value assignment:** Consecutive number with maximum value = 9 999, starting again with 0. At the time of first issuing of the card the number is set to 0.

#### 2.47. Datef

Date expressed in a readily printable numeric format.

*Datef ::= SEQUENCE {*

*year BCDString(SIZE(2)),*

*month BCDString(SIZE(1)),*

*day BCDString(SIZE(1))*

*}*

**Value assignment:**

yyyy	Year
mm	Month
dd	Day

'00000000'H denotes explicitly no date.

#### 2.48. Distance

A distance travelled (result of the calculation of the difference between two vehicle's odometer value in kilometres).

*Distance ::= INTEGER(0..2<sup>16</sup>-1)*

**Value assignment:** Unsigned binary. Value in km in the operational range 0 to 9 999 km.

#### 2.49. DriverCardApplicationIdentification

Information, stored in a driver card related to the identification of the application of the card (requirement 190).

*DriverCardApplicationIdentification ::= SEQUENCE {*

*typeOfTachographCardId EquipmentType,*

*cardStructureVersion CardStructureVersion,*

*noOfEventsPerType NoOfEventsPerType,*

*noOfFaultsPerType NoOfFaultsPerType,*

---

**Changes to legislation:** There are currently no known outstanding effects for the Council Regulation (EEC) No 3821/85. (See end of Document for details)

---

*activityStructureLength CardActivityLengthRange,*  
*noOfCardVehicleRecords NoOfCardVehicleRecords,*  
*noOfCardPlaceRecords NoOfCardPlaceRecords*  
 }

**typeOfTachographCardId** is specifying the implemented type of card.

**cardStructureVersion** is specifying the version of the structure that is implemented in the card.

**noOfEventsPerType** is the number of events per type of event the card can record.

**noOfFaultsPerType** is the number of faults per type of fault the card can record.

**activityStructureLength** indicates the number of bytes available for storing activity records.

**noOfCardVehicleRecords** is the number of vehicle records the card can contain.

**noOfCardPlaceRecords** is the number of places the card can record.

#### 2.50. DriverCardHolderIdentification

Information, stored in a driver card, related to the identification of the cardholder (requirement 195).

*DriverCardHolderIdentification ::= SEQUENCE {*  
*cardHolderName HolderName,*  
*cardHolderBirthDate Datef,*  
*cardHolderPreferredLanguage Language*  
 }

**cardHolderName** is the name and first name(s) of the holder of the Driver Card.

**cardHolderBirthDate** is the date of birth of the holder of the Driver Card.

**cardHolderPreferredLanguage** is the preferred language of the card holder.

#### 2.51. EntryTypeDailyWorkPeriod

Code to distinguish between begin and end for an entry of a daily work period place and condition of the entry.

*EntryTypeDailyWorkPeriod ::= INTEGER*  
*Begin, related time = card insertion time or time of entry (0),*  
*End, related time = card withdrawal time or time of entry (1),*  
*Begin, related time manually entered (start time) (2),*  
*End, related time manually entered (end of work period) (3),*  
*Begin, related time assumed by VU (4),*  
*End, related time assumed by VU (5)*  
 }

---

*Changes to legislation: There are currently no known outstanding effects for the Council Regulation (EEC) No 3821/85. (See end of Document for details)*

---

**Value assignment:** according to ISO/IEC8824-1.

#### 2.52. EquipmentType

Code to distinguish different types of equipment for the tachograph application.

*EquipmentType ::= INTEGER(0..255)*

- Reserved (0),
- Driver Card (1),
- Workshop Card (2),
- Control Card (3),
- Company Card (4),
- Manufacturing Card (5),
- Vehicle Unit (6),
- Motion Sensor (7),
- RFU (8..255)

**Value assignment:** According to ISO/IEC 8824-1.

Value 0 is reserved for the purpose of designating a Member State or Europe in the CHA field of certificates.

#### 2.53. EuropeanPublicKey

The European public key.

*EuropeanPublicKey ::= PublicKey.*

#### 2.54. EventFaultType

Code qualifying an event or a fault.

*EventFaultType ::= OCTET STRING (SIZE(1)).*

**Value assignment:**

'0x'H	General events,
'00'H	No further details,
'01'H	Insertion of a non-valid card,
'02'H	Card conflict,
'03'H	Time overlap,
'04'H	Driving without an appropriate card,
'05'H	Card insertion while driving,
'06'H	Last card session not correctly closed,
'07'H	Over speeding,
'08'H	Power supply interruption,
'09'H	Motion data error,
[ <sup>F15</sup> '0A'H	Vehicle Motion Conflict,
'0B'H to '0F'H	RFU,]
'1x'H	Vehicle unit related security breach attempt events,
'10'H	No further details,

---

**Changes to legislation:** There are currently no known outstanding effects for the Council Regulation (EEC) No 3821/85. (See end of Document for details)

---

'11'H	Motion sensor authentication failure,
'12'H	Tachograph card authentication failure,
'13'H	Unauthorised change of motion sensor,
'14'H	Card data input integrity error
'15'H	Stored user data integrity error,
'16'H	Internal data transfer error,
'17'H	Unauthorised case opening,
'18'H	Hardware sabotage,
'19'H to '1F'H	RFU,
'2x'H	Sensor related security breach attempt events,
'20'H	No further details,
'21'H	Authentication failure,
'22'H	Stored data integrity error,
'23'H	Internal data transfer error,
'24'H	Unauthorised case opening,
'25'H	Hardware sabotage,
'26'H to '2F'H	RFU,
'3x'H	Recording equipment faults,
'30'H	No further details,
'31'H	VU internal fault,
'32'H	Printer fault,
'33'H	Display fault,
'34'H	Downloading fault,
'35'H	Sensor fault,
'36'H to '3F'H	RFU
'4x'H	Card faults,
'40'H	No further details,
'41'H to '4F'H	RFU
'50'H to '7F'H	RFU,
'80'H to 'FF'H	Manufacturer specific.

#### 2.55. EventFaultRecordPurpose

Code explaining why an event or a fault has been recorded.

*EventFaultRecordPurpose ::= OCTET STRING (SIZE(1)).*

#### Value assignment:

'00'H	one of the 10 most recent (or last) events or faults
'01'H	the longest event for one of the last 10 days of occurrence
'02'H	one of the 5 longest events over the last 365 days
'03'H	the last event for one of the last 10 days of occurrence
'04'H	the most serious event for one of the last 10 days of occurrence
'05'H	one of the 5 most serious events over the last 365 days
'06'H	the first event or fault having occurred after the last calibration
'07'H	an active/on-going event or fault
'08'H to '7F'H	RFU
'80'H to 'FF'H	manufacturer specific.

#### 2.56. ExtendedSerialNumber

Unique identification of an equipment. It can also be used as an equipment Public Key Identifier.

---

*Changes to legislation: There are currently no known outstanding effects for the Council Regulation (EEC) No 3821/85. (See end of Document for details)*

---

```

ExtendedSerialNumber ::= SEQUENCE {
serialNumber INTEGER(0..232-1)
monthYear BCDString(SIZE(2))
type OCTET STRING(SIZE(1))
manufacturerCode ManufacturerCode
}

```

**serialNumber** is a serial number for the equipment, unique for the manufacturer, the equipment's type and the month below.

**monthYear** is the identification of the month and the year of manufacturing (or of serial number assignment).

**Value assignment:** BCD coding of Month (two digits) and Year (two last digits).

**type** is an identifier of the type of equipment.

**Value assignment:** manufacturer specific, with FFh' reserved value.

**manufacturerCode:** is the numerical code of the manufacturer of the equipment.

#### 2.57. FullCardNumber

Code fully identifying a tachograph card.

```

FullCardNumber ::= SEQUENCE {
cardType EquipmentType,
cardIssuingMemberState NationNumeric,
cardNumber CardNumber
}

```

**cardType** is the type of the tachograph card.

**cardIssuingMemberState** is the code of the Member State having issued the card.

**cardNumber** is the card number.

#### 2.58. HighResOdometer

Odometer value of the vehicle: Accumulated distance travelled by the vehicle during its operation.

```

HighResOdometer ::= INTEGER(0..232-1)

```

**Value assignment:** Unsigned binary. Value in 1/200 km in the operating range 0 to 21 055 406 km.

#### 2.59. HighResTripDistance

A distance travelled during all or part of a journey.

```

HighResTripDistance ::= INTEGER(0..232-1)

```

**Value assignment:** Unsigned binary. Value in 1/200 km in the operating range 0 to 21 055 406 km.

#### 2.60. HolderName

The surname and first name(s) of a card holder.

*HolderName ::= SEQUENCE {*

*holderSurname Name,*

*holderFirstNames Name*

*}*

**holderSurname** is the surname (family name) of the holder. This surname does not include titles.

**Value assignment:** When a card is not personal, holderSurname contains the same information as companyName or workshopName or controlBodyName.

**holderFirstNames** is the first name(s) and initials of the holder.

#### 2.61. K-ConstantOfRecordingEquipment

Constant of the recording equipment (definition m)).

*K-ConstantOfRecordingEquipment ::= INTEGER(0..2<sup>16</sup>-1)*

**Value assignment:** Pulses per kilometre in the operating range 0 to 64 255 pulses/km.

#### 2.62. KeyIdentifier

A unique identifier of a Public Key used to reference and select the key. It also identifies the holder of the key.

*KeyIdentifier ::= CHOICE {*

*extendedSerialNumber ExtendedSerialNumber,*

*certificateRequestID CertificateRequestID,*

*certificationAuthorityKID CertificationAuthorityKID*

*}*

The first choice is suitable to reference the public key of a Vehicle Unit or of a tachograph card.

The second choice is suitable to reference the public key of a Vehicle Unit (in the case the serial number of the Vehicle Unit cannot be known at certificate generation time).

The third choice is suitable to reference the public key of a Member State.

#### 2.63. L-TyreCircumference

Effective circumference of the wheel tyres (definition u)).

*L-TyreCircumference ::= INTEGER(0..2<sup>16</sup>-1)*

**Value assignment:** Unsigned binary, value in 1/8 mm in the operating range 0 to 8 031 mm.

#### 2.64. Language

---

*Changes to legislation: There are currently no known outstanding effects for the Council Regulation (EEC) No 3821/85. (See end of Document for details)*

---

Code identifying a language.

*Language ::= IA5String(SIZE(2))*

**Value assignment:** Two-letter lower-case coding according to ISO 639.

2.65. LastCardDownload

Date and time, stored on a driver card, of last card download (for other purposes than control). This date is updateable by a VU or any card reader.

*LastCardDownload ::= TimeReal*

**Value assignment:** not further specified.

2.66. ManualInputFlag

Code identifying whether a cardholder has manually entered driver activities at card insertion or not (requirement 081).

*ManualInputFlag ::= INTEGER {*

*noEntry (0)*

*manualEntries (1)*

*}*

**Value assignment:** not further specified.

[<sup>F15</sup>2.67. ManufacturerCode

Code identifying a manufacturer of type-approved equipment.

ManufacturerCode: = INTEGER (0..255)

The laboratory competent for interoperability tests maintains and publishes the list of manufacturer codes on its web site (requirement 290).

ManufacturerCodes are provisionally assigned to developers of tachograph equipment on application to the laboratory competent for interoperability tests.]

2.68. MemberStateCertificate

The certificate of the public key of a Member State issued by the European certification authority.

*MemberStateCertificate ::= Certificate*

2.69. MemberStatePublicKey

The public key of a Member State.

*MemberStatePublicKey ::= PublicKey.*

[<sup>F15</sup>2.70. Name

A name.

Name: = SEQUENCE {

codePage INTEGER (0..255),



name OCTET STRING (SIZE(35))

}

**codePage** specifies a character set defined in Chapter 4,

**name** is a name encoded using the specified character set.]

[<sup>F15</sup>2.71. NationAlpha

Alphabetic reference to a country shall be in accordance with the distinguishing signs used on vehicles in international traffic (United Nations Vienna Convention on Road Traffic, 1968).

NationAlpha: = IA5String (SIZE (3))

The Nation Alpha and Numeric codes shall be held on a list maintained on the website of the laboratory appointed to carry out interoperability testing, as set out in Requirement 278.]

[<sup>F15</sup>2.72. NationNumeric

Numerical reference to a country.

NationNumeric: = INTEGER (0.. 255)

Value assignment: see data type 2.71 (NationAlpha)

Any amendment or updating of the Nation Alpha or Numeric specification described in the above paragraph shall only be made out after the appointed laboratory has obtained the views of type approved digital tachograph vehicle unit manufacturers.]

2.73. NoOfCalibrationRecords

Number of calibration records, a workshop card can store.

*NoOfCalibrationRecords ::= INTEGER(0..255)*

**Value assignment:** see paragraph 3.

2.74. NoOfCalibrationsSinceDownload

Counter indicating the number of calibrations performed with a workshop card since its last download (requirement 230).

*NoOfCalibrationsSinceDownload ::= INTEGER(0..2<sup>16</sup>-1),*

**Value assignment:** Not specified further.

2.75. NoOfCardPlaceRecords

Number of place records a driver or workshop card can store.

*NoOfCardPlaceRecords ::= INTEGER(0..255)*

**Value assignment:** see paragraph 3.

2.76. NoOfCardVehicleRecords

Number of vehicles used records a driver or workshop card can store.

*NoOfCardVehicleRecords ::= INTEGER(0..2<sup>16</sup>-1)*

---

*Changes to legislation: There are currently no known outstanding effects for the Council Regulation (EEC) No 3821/85. (See end of Document for details)*

---

**Value assignment:** see paragraph 3.

2.77. NoOfCompanyActivityRecords

Number of company activity records, a company card can store.

*NoOfCompanyActivityRecords ::= INTEGER(0..2<sup>16</sup>-1)*

**Value assignment:** see paragraph 3.

2.78. NoOfControlActivityRecords

Number of control activity records, a control card can store.

*NoOfControlActivityRecords ::= INTEGER(0..2<sup>16</sup>-1)*

**Value assignment:** see paragraph 3.

2.79. NoOfEventsPerType

Number of events per type of event a card can store.

*NoOfEventsPerType ::= INTEGER(0..255)*

**Value assignment:** see paragraph 3.

2.80. NoOfFaultsPerType

Number of faults per type of fault a card can store.

*NoOfFaultsPerType ::= INTEGER(0..255)*

**Value assignment:** see paragraph 3.

2.81. OdometerValueMidnight

The vehicle's odometer value at midnight on a given day (requirement 090).

*OdometerValueMidnight ::= OdometerShort*

**Value assignment:** not further specified.

2.82. OdometerShort

Odometer value of the vehicle in a short form.

*OdometerShort ::= INTEGER(0..2<sup>24</sup>-1)*

**Value assignment:** Unsigned binary. Value in km in the operating range 0 to 9 999 999 km.

2.83. OverspeedNumber

Number of over speeding events since the last over speeding control.

*OverspeedNumber ::= INTEGER(0..255)*

**Value assignment:** 0 means that no over speeding event has occurred since the last over speeding control, 1 means that one over speeding event has occurred since the last over speeding control ... 255 means that 255 or more over speeding events have occurred since the last over speeding control.

2.84. PlaceRecord

---

**Changes to legislation:** There are currently no known outstanding effects for the Council Regulation (EEC) No 3821/85. (See end of Document for details)

---

Information related to a place where a daily work period begins or ends (requirements 087, 202, 221).

```
PlaceRecord ::= SEQUENCE {
    entryTime TimeReal,
    entryTypeDailyWorkPeriod EntryTypeDailyWorkPeriod,
    dailyWorkPeriodCountry NationNumeric,
    dailyWorkPeriodRegion RegionNumeric,
    vehicleOdometerValue OdometerShort
}
```

**entryTime** is a date and time related to the entry.

**entryTypeDailyWorkPeriod** is the type of entry.

**dailyWorkPeriodCountry** is the country entered.

**dailyWorkPeriodRegion** is the region entered.

**vehicleOdometerValue** is the odometer value at the time of place entry.

#### 2.85. PreviousVehicleInfo

Information related to the vehicle previously used by a driver when inserting his card in a vehicle unit (requirement 081).

```
PreviousVehicleInfo ::= SEQUENCE {
    vehicleRegistrationIdentification VehicleRegistrationIdentification,
    cardWithdrawalTime TimeReal
}
```

**vehicleRegistrationIdentification** is the VRN and the registering Member State of the vehicle.

**cardWithdrawalTime** is the card withdrawal date and time.

#### 2.86. PublicKey

A public RSA key.

```
PublicKey ::= SEQUENCE {
    rsaKeyModulus RSAKeyModulus,
    rsaKeyPublicExponent RSAKeyPublicExponent
}
```

**rsaKeyModulus** is the Modulus of the key pair.

**rsaKeyPublicExponent** is the public exponent of the key pair.

#### 2.87. RegionAlpha

Alphabetic reference to a region within a specified country.

---

*Changes to legislation: There are currently no known outstanding effects for the Council Regulation (EEC) No 3821/85. (See end of Document for details)*

---

*RegionAlpha ::= IA5STRING(SIZE(3))*

**Value assignment:**

' '	No information available
Spain:	
'AN'	Andalucía
'AR'	Aragón
'AST'	Asturias
'C'	Cantabria
'CAT'	Cataluña
'CL'	Castilla-León
'CM'	Castilla-La-Mancha
'CV'	Valencia
'EXT'	Extremadura
'G'	Galicia
'IB'	Baleares
'IC'	Canarias
'LR'	La Rioja
'M'	Madrid
'MU'	Murcia
'NA'	Navarra
[ <sup>XI</sup> 'PV'	País Vasco

2.88. RegionNumeric

Numerical reference to a region within a specified country.

*RegionNumeric ::= OCTET STRING (SIZE(1))*

**Value assignment:**

'00'H	No information available
Spain:	
'01'H	Andalucía
'02'H	Aragón
'03'H	Asturias
'04'H	Cantabria
'05'H	Cataluña
'06'H	Castilla-León
'07'H	Castilla-La-Mancha
'08'H	Valencia
'09'H	Extremadura
'0A'H	Galicia
'0B'H	Baleares
'0C'H	Canarias
'0D'H	La Rioja
'0E'H	Madrid
'0F'H	Murcia
'10'H	Navarra
'11'H	País Vasco.

2.89. RSAKeyModulus

---

*Changes to legislation: There are currently no known outstanding effects for the Council Regulation (EEC) No 3821/85. (See end of Document for details)*

---

The modulus of a RSA key pair.

*RSAPublicModulus ::= OCTET STRING (SIZE(128))*

**Value assignment:** Unspecified.

2.90. RSAKeyPrivateExponent

The private exponent of a RSA key pair.

*RSAPrivateExponent ::= OCTET STRING (SIZE(128))*

**Value assignment:** Unspecified.

2.91. RSAKeyPublicExponent

The public exponent of a RSA key pair.

*RSAPublicExponent ::= OCTET STRING (SIZE(8))*

**Value assignment:** Unspecified.

2.92. SensorApprovalNumber

Type approval number of the sensor.

*SensorApprovalNumber ::= IA5String(SIZE(8))*

**Value assignment:** Unspecified.

2.93. SensorIdentification

Information, stored in a motion sensor, related to the identification of the motion sensor (requirement 077).

*SensorIdentification ::= SEQUENCE {*  
*sensorSerialNumber SensorSerialNumber,*  
*sensorApprovalNumber SensorApprovalNumber,*  
*sensorSCIdentifier SensorSCIdentifier,*  
*sensorOSIdentifier SensorOSIdentifier*  
*}*

**sensorSerialNumber** is the extended serial number of the motion sensor (includes part number and manufacturer code).

**sensorApprovalNumber** is the approval number of the motion sensor.

**sensorSCIdentifier** is the identifier of the security component of the motion sensor.

**sensorOSIdentifier** is the identifier of the operating system of the motion sensor.

2.94. SensorInstallation

Information, stored in a motion sensor, related to the installation of the motion sensor (requirement 099).

*SensorInstallation ::= SEQUENCE {*

---

*Changes to legislation: There are currently no known outstanding effects for the Council Regulation (EEC) No 3821/85. (See end of Document for details)*

---

```

sensorPairingDateFirst SensorPairingDate,
firstVuApprovalNumber VuApprovalNumber,
firstVuSerialNumber VuSerialNumber,
sensorPairingDateCurrent SensorPairingDate,
currentVuApprovalNumber VuApprovalNumber,
currentVUSerialNumber VuSerialNumber
}

```

**sensorPairingDateFirst** is the date of the first pairing of the motion sensor with a vehicle unit.

**firstVuApprovalNumber** is the approval number of the first vehicle unit paired with the motion sensor.

**firstVuSerialNumber** is the serial number of the first vehicle unit paired with the motion sensor.

**sensorPairingDateCurrent** is the date of the current pairing of the motion sensor with the vehicle unit.

**currentVuApprovalNumber** is the approval number of the vehicle unit currently paired with the motion sensor.

**currentVUSerialNumber** is the serial number of the vehicle unit currently paired with the motion sensor.

#### 2.95. *SensorInstallationSecData*

Information, stored in a workshop card, related to the security data needed for pairing motion sensors to vehicle units (requirement 214).

*SensorInstallationSecData ::= TDesSessionKey*

**Value assignment:** in accordance with ISO 16844-3.

#### 2.96. *SensorOSIdentifier*

Identifier of the operating system of the motion sensor.

*SensorOSIdentifier ::= IA5String(SIZE(2))*

**Value assignment:** manufacturer specific.

#### 2.97. *SensorPaired*

Information, stored in a vehicle unit, related to the identification of the motion sensor paired with the vehicle unit (requirement 079).

*SensorPaired ::= SEQUENCE {*

*sensorSerialNumber* *SensorSerialNumber*,

*sensorApprovalNumber* *SensorApprovalNumber*,

*sensorPairingDateFirst* *SensorPairingDate*

*}*

---

**Changes to legislation:** There are currently no known outstanding effects for the Council Regulation (EEC) No 3821/85. (See end of Document for details)

---

**sensorSerialNumber** is the serial number of the motion sensor currently paired with the vehicle unit.

**sensorApprovalNumber** is the approval number of the motion sensor currently paired with the vehicle unit.

**sensorPairingDateFirst** is the date of the first pairing with a vehicle unit of the motion sensor currently paired with the vehicle unit.

#### 2.98. SensorPairingDate

Date of a pairing of the motion sensor with a vehicle unit.

*SensorPairingDate ::= TimeReal*

**Value assignment:** Unspecified.

#### 2.99. SensorSerialNumber

*Serial number of the motion sensor.*

*SensorSerialNumber ::= ExtendedSerialNumber:*

#### 2.100. SensorSCIdentifier

Identifier of the security component of the motion sensor.

*SensorSCIdentifier ::= IA5String(SIZE(8))*

**Value assignment:** component manufacturer specific.

#### 2.101. Signature

A digital signature.

*Signature ::= OCTET STRING (SIZE(128))*

**Value assignment:** in accordance with Appendix 11, 'Common security mechanisms'.

#### 2.102. SimilarEventsNumber

The number of similar events for one given day (requirement 094).

*SimilarEventsNumber ::= INTEGER(0..255)*

**Value assignment:** 0 is not used, 1 means that only one event of that type have occurred and have been stored on that day, 2 means that 2 events of that type have occurred on that day (one only has been stored), ... 255 means that 255 or more events of that type have occurred on that day.

#### 2.103. SpecificConditionType

Code identifying a specific condition (requirements 050b, 105a, 212a and 230a).

*SpecificConditionType ::= INTEGER(0..255)*

**Value assignment:**

'00'H	RFU
'01'H	Out of scope — Begin
'02'H	Out of scope — End
'03'H	Ferry/Train crossing

---

*Changes to legislation: There are currently no known outstanding effects for the Council Regulation (EEC) No 3821/85. (See end of Document for details)*

---

'04'H .. 'FF'H            RFU.

#### 2.104.    SpecificConditionRecord

Information, stored in a driver card, a workshop card or a vehicle unit, related to a specific condition (requirements 105a, 212a and 230a).

```
SpecificConditionRecord ::= SEQUENCE {
    entryTime TimeReal,
    specificConditionType SpecificConditionType
}
```

**entryTime** is the date and time of the entry.

**specificConditionType** is the code identifying the specific condition.

#### 2.105.    Speed

Speed of the vehicle (km/h).

```
Speed ::= INTEGER(0..255)
```

**Value assignment:** kilometre per hour in the operational range 0 to 220 km/h.

#### 2.106.    SpeedAuthorised

Maximum authorised Speed of the vehicle (definition bb)).

```
SpeedAuthorised ::= Speed.
```

#### 2.107.    SpeedAverage

Average speed in a previously defined duration (km/h).

```
SpeedAverage ::= Speed.
```

#### 2.108.    SpeedMax

Maximum speed measured in a previously defined duration.

```
SpeedMax ::= Speed.
```

#### 2.109.    TDesSessionKey

A triple DES session key.

```
TDesSessionKey ::= SEQUENCE {
    tDesKeyA OCTET STRING (SIZE(8))
    tDesKeyB OCTET STRING (SIZE(8))
}
```

**Value assignment:** not further specified.

#### 2.110.    TimeReal

Code for a combined date and time field, where the date and time are expressed as seconds past 00h.00m.00s. on 1 January 1970 GMT.



---

**Changes to legislation:** There are currently no known outstanding effects for the Council Regulation (EEC) No 3821/85. (See end of Document for details)

---

*TimeReal*{*INTEGER:TimeRealRange*} ::= *INTEGER*(0..*TimeRealRange*)

**Value assignment — Octet Aligned:** Number of seconds since midnight 1 January 1970 GMT.

The max possible date/time is in the year 2106.

#### 2.111. TyreSize

Designation of tyre dimensions.

*TyreSize* ::= *IA5String*(*SIZE*(15))

**Value assignment:** in accordance with Directive 92/23 (EEC) 31.3.1992, OJ L 129, p. 95.

#### 2.112. VehicleIdentificationNumber

Vehicle Identification Number (VIN) referring to the vehicle as a whole, normally chassis serial number or frame number.

*VehicleIdentificationNumber* ::= *IA5String*(*SIZE*(17))

**Value assignment:** As defined in ISO 3779.

#### 2.113. VehicleRegistrationIdentification

Identification of a vehicle, unique for Europe (VRN and Member State).

*VehicleRegistrationIdentification* ::= *SEQUENCE* {

*vehicleRegistrationNation* *NationNumeric*,

*vehicleRegistrationNumber* *VehicleRegistrationNumber*

}

**vehicleRegistrationNation** is the nation where the vehicle is registered.

**vehicleRegistrationNumber** is the registration number of the vehicle (VRN).

[<sup>F15</sup>2.114. *VehicleRegistrationNumber*

Registration number of the vehicle (VRN). The registration number is assigned by the vehicle licensing authority.

*VehicleRegistrationNumber*: = *SEQUENCE* {

*codePage* *INTEGER* (0..255),

*vehicleRegNumber* *OCTET STRING* (*SIZE*(13))

}

**codePage** specifies a character set defined in Chapter 4,

**vehicleRegNumber** is a VRN encoded using the specified character set.

**Value assignment:** Country specific.]

#### 2.115. VuActivityDailyData

---

*Changes to legislation: There are currently no known outstanding effects for the Council Regulation (EEC) No 3821/85. (See end of Document for details)*

---

Information, stored in a VU, related to changes of activity and/or changes of driving status and/or changes of card status for a given calendar day (requirement 084) and to slots status at 00.00 that day.

```
VuActivityDailyData ::= SEQUENCE {
noOfActivityChanges INTEGER SIZE(0..1 440),
activityChangeInfos SET SIZE(noOfActivityChanges) OF ActivityChangeInfo
}
```

**noOfActivityChanges** is the number of ActivityChangeInfo words in the activityChangeInfos set.

**activityChangeInfos** is the set of ActivityChangeInfo words stored in the VU for the day. It always includes two ActivityChangeInfo words giving the status of the two slots at 00.00 that day.

#### 2.116. VuApprovalNumber

Type approval number of the vehicle unit.

```
VuApprovalNumber ::= IA5String(SIZE(8))
```

**Value assignment:** Unspecified.

#### 2.117. VuCalibrationData

Information, stored in a vehicle unit, related to the calibrations of the recording equipment (requirement 098).

```
VuCalibrationData ::= SEQUENCE {
noOfVuCalibrationRecords INTEGER(0..255),
vuCalibrationRecords SET SIZE(noOfVuCalibrationRecords) OF VuCalibrationRecord
}
```

**noOfVuCalibrationRecords** is the number of records contained in the vuCalibrationRecords set.

**vuCalibrationRecords** is the set of calibration records.

#### 2.118. VuCalibrationRecord

Information, stored in a vehicle unit, related a calibration of the recording equipment (requirement 098).

```
VuCalibrationRecord ::= SEQUENCE {
calibrationPurpose CalibrationPurpose,
workshopName Name,
workshopAddress Address,
workshopCardNumber FullCardNumber,
workshopCardExpiryDate TimeReal,
```

---

**Changes to legislation:** There are currently no known outstanding effects for the Council Regulation (EEC) No 3821/85. (See end of Document for details)

---

*vehicleIdentificationNumber VehicleIdentificationNumber,*  
*vehicleRegistrationIdentification VehicleRegistrationIdentification,*  
*wVehicleCharacteristicConstant W-VehicleCharacteristicConstant,*  
*kConstantOfRecordingEquipment K-ConstantOfRecordingEquipment,*  
*lTyreCircumference L-TyreCircumference,*  
*tyreSize TyreSize,*  
*authorisedSpeed SpeedAuthorised,*  
*oldOdometerValue OdometerShort,*  
*newOdometerValue OdometerShort,*  
*oldTimeValue TimeReal,*  
*newTimeValue TimeReal,*  
*nextCalibrationDate TimeReal*  
 }

**calibrationPurpose** is the purpose of the calibration.

**workshopName, workshopAddress** are the workshop name and address.

**workshopCardNumber** identifies the workshop card used during the calibration.

**workshopCardExpiryDate** is the card expiry date.

**vehicleIdentificationNumber** is the VIN.

**vehicleRegistrationIdentification** contains the VRN and registering Member State.

**wVehicleCharacteristicConstant** is the characteristic coefficient of the vehicle.

**kConstantOfRecordingEquipment** is the constant of the recording equipment.

**lTyreCircumference** is the effective circumference of the wheel tyres.

**tyreSize** is the designation of the dimension of the tyres mounted on the vehicle.

**authorisedSpeed** is the authorised speed of the vehicle.

**oldOdometerValue, newOdometerValue** are the old and new values of the odometer.

**oldTimeValue, newTimeValue** are the old and new values of date and time.

**nextCalibrationDate** is the date of the next calibration of the type specified in CalibrationPurpose to be carried out by the authorised inspection authority.

#### 2.119. VuCardIWDData

Information, stored in a vehicle unit, related to insertion and withdrawal cycles of driver cards or of workshop cards in the vehicle unit (requirement 081).

---

*Changes to legislation: There are currently no known outstanding effects for the Council Regulation (EEC) No 3821/85. (See end of Document for details)*

---

```

VuCardIWData ::= SEQUENCE {
    noOfIWRecords          INTEGER(0..216-1),
    vuCardIWRecords       SET SIZE(noOfIWRecords) OF
[X1] VuCardIWRecord
}

```

**noOfIWRecords** is the number of records in the set vuCardIWRecords.

**vuCardIWRecords** is a set of records related to card insertion withdrawal cycles.

#### 2.120. VuCardIWRecord

Information, stored in a vehicle unit, related to an insertion and withdrawal cycle of a driver card or of a workshop card in the vehicle unit (requirement 081).

```

VuCardIWRecord ::= SEQUENCE {
    cardHolderName HolderName,
    fullCardNumber FullCardNumber,
    cardExpiryDate TimeReal,
    cardInsertionTime TimeReal,
    vehicleOdometerValueAtInsertion OdometerShort,
    cardSlotNumber CardSlotNumber,
    cardWithdrawalTime TimeReal,
    vehicleOdometerValueAtWithdrawal OdometerShort,
    previousVehicleInfo PreviousVehicleInfo
    manualInputFlag ManualInputFlag
}

```

**cardHolderName** is the driver or workshop card holder's surname and first names as stored in the card.

**fullCardNumber** is the type of card, its issuing Member State and its card number as stored in the card.

**cardExpiryDate** is the card's expiry date as stored in the card.

**cardInsertionTime** is the insertion date and time.

**vehicleOdometerValueAtInsertion** is the vehicle odometer value at card insertion.

**cardSlotNumber** is the slot in which the card is inserted.

**cardWithdrawalTime** is the withdrawal date and time.

**vehicleOdometerValueAtWithdrawal** is the vehicle odometer value at card withdrawal.

**previousVehicleInfo** contains information about the previous vehicle used by the driver, as stored in the card.

---

**Changes to legislation:** There are currently no known outstanding effects for the Council Regulation (EEC) No 3821/85. (See end of Document for details)

---

**manualInputFlag** is a flag identifying if the cardholder has manually entered driver activities at card insertion.

#### 2.121. VuCertificate

Certificate of the public key of a vehicle unit.

*VuCertificate ::= Certificate*

#### 2.122. VuCompanyLocksData

Information, stored in a vehicle unit, related to company locks (requirement 104).

*VuCompanyLocksData ::= SEQUENCE {*

*noOfLocks INTEGER(0..20),*

*vuCompanyLocksRecords SET SIZE(noOfLocks) OF VuCompanyLocksRecord*

*}*

**noOfLocks** is the number of locks listed in *vuCompanyLocksRecords*.

**vuCompanyLocksRecords** is the set of company locks records.

#### 2.123. VuCompanyLocksRecord

Information, stored in a vehicle unit, related to one company lock (requirement 104).

*VuCompanyLocksRecord ::= SEQUENCE {*

*lockInTime TimeReal,*

*lockOutTime TimeReal,*

*companyName Name,*

*companyAddress Address,*

*companyCardNumber FullCardNumber*

*}*

**lockInTime**, **lockOutTime** are the date and time of lock-in and lock-out.

**companyName**, **companyAddress** are the company name and address related with the lock-in.

**companyCardNumber** identifies the card used at lock-in.

#### 2.124. VuControlActivityData

Information, stored in a vehicle unit, related to controls performed using this VU (requirement 102).

*VuControlActivityData ::= SEQUENCE {*

*noOfControls INTEGER(0..20),*

*vuControlActivityRecords SET SIZE(noOfControls) OF VuControlActivityRecord*

*}*

**noOfControls** is the number of controls listed in *vuControlActivityRecords*.

---

*Changes to legislation: There are currently no known outstanding effects for the Council Regulation (EEC) No 3821/85. (See end of Document for details)*

---

**VuControlActivityRecords** is the set of control activity records.

#### 2.125. VuControlActivityRecord

Information, stored in a vehicle unit, related to a control performed using this VU (requirement 102).

```
VuControlActivityRecord ::= SEQUENCE {
controlType ControlType,
controlTime TimeReal,
controlCardNumber FullCardNumber,
downloadPeriodBeginTime TimeReal,
downloadPeriodEndTime TimeReal
}
```

**controlType** is the type of the control.

**controlTime** is the date and time of the control.

**ControlCardNumber** identifies the control card used for the control.

**downloadPeriodBeginTime** is the begin time of the downloaded period, in case of downloading.

**downloadPeriodEndTime** is the end time of the downloaded period, in case of downloading.

#### 2.126. VuDataBlockCounter

Counter, stored in a card, identifying sequentially the insertion withdrawal cycles of the card in vehicle units.

```
VuDataBlockCounter ::= BCDString(SIZE(2))
```

**Value assignment:** Consecutive Number with max. value 9 999, starting again with 0.

#### 2.127. VuDetailedSpeedBlock

Information, stored in a vehicle unit, related to the vehicle's detailed speed for a minute during which the vehicle has been moving (requirement 093).

```
VuDetailedSpeedBlock ::= SEQUENCE {
speedBlockBeginDate TimeReal,
speedsPerSecond SEQUENCE SIZE(60) OF Speed
}
```

**speedBlockBeginDate** is the date and time of the first speed value within the block.

**speedsPerSecond** is the chronological sequence of measured speeds every seconds for the minute starting at speedBlockBeginDate (included).

#### 2.128. VuDetailedSpeedData

Information, stored in a vehicle unit, related to the detailed speed of the vehicle.

---

**Changes to legislation:** There are currently no known outstanding effects for the Council Regulation (EEC) No 3821/85. (See end of Document for details)

---

```
VuDetailedSpeedData ::= SEQUENCE
noOfSpeedBlocks INTEGER(0..216-1),
vuDetailedSpeedBlocks SET SIZE(noOfSpeedBlocks) OF VuDetailedSpeedBlock
}
```

**noOfSpeedBlocks** is the number of speed blocks in the vuDetailedSpeedBlocks set.

**vuDetailedSpeedBlocks** is the set of detailed speed blocks.

#### 2.129. VuDownloadablePeriod

Oldest and latest dates for which a vehicle unit holds data related to drivers activities (requirements 081, 084 or 087).

```
VuDownloadablePeriod ::= SEQUENCE {
minDownloadableTime TimeReal
maxDownloadableTime TimeReal
}
```

**minDownloadableTime** is the oldest card insertion or activity change or place entry date and time stored in the VU.

**maxDownloadableTime** is the latest card withdrawal or activity change or place entry date and time stored in the VU.

#### 2.130. VuDownloadActivityData

Information, stored in a vehicle unit, related to its last download (requirement 105).

```
VuDownloadActivityData ::= SEQUENCE {
downloadingTime TimeReal,
fullCardNumber FullCardNumber,
companyOrWorkshopName Name
}
```

**downloadingTime** is the date and time of downloading.

**fullCardNumber** identifies the card used to authorise the download.

**companyOrWorkshopName** is the company or workshop name.

#### 2.131. VuEventData

Information, stored in a vehicle unit, related to events (requirement 094 except over speeding event).

```
VuEventData ::= SEQUENCE {
noOfVuEvents INTEGER(0..255),
vuEventRecords SET SIZE(noOfVuEvents) OF VuEventRecord
```

---

*Changes to legislation: There are currently no known outstanding effects for the Council Regulation (EEC) No 3821/85. (See end of Document for details)*

---

}

**noOfVuEvents** is the number of events listed in the vuEventRecords set.

**vuEventRecords** is a set of events records.

#### 2.132. VuEventRecord

Information, stored in a vehicle unit, related to an event (requirement 094 except over speeding event).

```
VuEventRecord ::= SEQUENCE {
eventType EventFaultType,
eventRecordPurpose EventFaultRecordPurpose,
eventBeginTime TimeReal,
eventEndTime TimeReal,
cardNumberDriverSlotBegin FullCardNumber,
cardNumberCodriverSlotBegin FullCardNumber,
cardNumberDriverSlotEnd FullCardNumber,
cardNumberCodriverSlotEnd FullCardNumber,
similarEventsNumber SimilarEventsNumber
}
```

**eventType** is the type of the event.

**eventRecordPurpose** is the purpose for which this event has been recorded.

**eventBeginTime** is the date and time of beginning of event.

**eventEndTime** is the date and time of end of event.

**cardNumberDriverSlotBegin** identifies the card inserted in the driver slot at the beginning of the event.

**cardNumberCodriverSlotBegin** identifies the card inserted in the co-driver slot at the beginning of the event.

**cardNumberDriverSlotEnd** identifies the card inserted in the driver slot at the end of the event.

**cardNumberCodriverSlotEnd** identifies the card inserted in the co-driver slot at the end of the event.

**similarEventsNumber** is the number of similar events that day.

This sequence can be used for all events other than over speeding events.

#### 2.133. VuFaultData

Information, stored in a vehicle unit, related to faults (requirement 096).

```
VuFaultData ::= SEQUENCE {
```



*noOfVuFaults* INTEGER(0..255),  
*vuFaultRecords* SET SIZE(*noOfVuFaults*) OF *VuFaultRecord*  
}

**noOfVuFaults** is the number of faults listed in the *vuFaultRecords* set.

**vuFaultRecords** is a set of faults records.

#### 2.134. VuFaultRecord

Information, stored in a vehicle unit, related to a fault (requirement 096).

*VuFaultRecord* ::= SEQUENCE {  
*faultType* *EventFaultType*,  
*faultRecordPurpose* *EventFaultRecordPurpose*,  
*faultBeginTime* *TimeReal*,  
*faultEndTime* *TimeReal*,  
*cardNumberDriverSlotBegin* *FullCardNumber*,  
*cardNumberCodriverSlotBegin* *FullCardNumber*,  
*cardNumberDriverSlotEnd* *FullCardNumber*,  
*cardNumberCodriverSlotEnd* *FullCardNumber*  
}

**faultType** is the type of recording equipment fault.

**faultRecordPurpose** is the purpose for which this fault has been recorded.

**faultBeginTime** is the date and time of beginning of fault.

**faultEndTime** is the date and time of end of fault.

**cardNumberDriverSlotBegin** identifies the card inserted in the driver slot at the beginning of the fault.

**cardNumberCodriverSlotBegin** identifies the card inserted in the co-driver slot at the beginning of the fault.

**cardNumberDriverSlotEnd** identifies the card inserted in the driver slot at the end of the fault.

**cardNumberCodriverSlotEnd** identifies the card inserted in the co-driver slot at the end of the fault.

#### 2.135. VuIdentification

Information, stored in a vehicle unit, related to the identification of the vehicle unit (requirement 075).

*VuIdentification* ::= SEQUENCE {  
*vuManufacturerName* *VuManufacturerName*,

---

*Changes to legislation: There are currently no known outstanding effects for the Council Regulation (EEC) No 3821/85. (See end of Document for details)*

---

*vuManufacturerAddress VuManufacturerAddress,*  
*vuPartNumber VuPartNumber,*  
*vuSerialNumber VuSerialNumber,*  
*vuSoftwareIdentification VuSoftwareIdentification,*  
*vuManufacturingDate VuManufacturingDate,*  
*vuApprovalNumber VuApprovalNumber*  
 }

**vuManufacturerName** is the name of the manufacturer of the vehicle unit.

**vuManufacturerAddress** is the address of the manufacturer of the vehicle unit.

**vuPartNumber** is the part number of the vehicle unit.

**vuSerialNumber** is the serial number of the vehicle unit.

**vuSoftwareIdentification** identifies the software implemented in the vehicle unit.

**vuManufacturingDate** is the manufacturing date of the vehicle unit.

**vuApprovalNumber** is the type approval number of the vehicle unit.

2.136. VuManufacturerAddress

Address of the manufacturer of the vehicle unit.

*VuManufacturerAddress ::= Address*

**Value assignment:** Unspecified.

2.137. VuManufacturerName

Name of the manufacturer of the vehicle unit.

*VuManufacturerName ::= Name*

**Value assignment:** Unspecified.

2.138. VuManufacturingDate

Date of manufacture of the vehicle unit.

*VuManufacturingDate ::= TimeReal*

**Value assignment:** Unspecified.

2.139. VuOverSpeedingControlData

Information, stored in a vehicle unit, related to over speeding events since the last over speeding control (requirement 095).

*VuOverSpeedingControlData ::= SEQUENCE {*

*lastOverspeedControlTime TimeReal,*

*firstOverspeedSince TimeReal,*

---

**Changes to legislation:** There are currently no known outstanding effects for the Council Regulation (EEC) No 3821/85. (See end of Document for details)

---

*numberOfOverspeedSince OverspeedNumber*

}

**lastOverspeedControlTime** is the date and time of the last over speeding control.

**firstOverspeedSince** is the date and time of the first over speeding following this over speeding control.

**numberOfOverspeedSince** is the number of over speeding events since the last over speeding control.

#### 2.140. VuOverSpeedingEventData

Information, stored in a vehicle unit, related to over speeding events (requirement 094).

*VuOverSpeedingEventData ::= SEQUENCE {*

*noOfVuOverSpeedingEvents INTEGER(0..255),*

*vuOverSpeedingEventRecords SET SIZE(noOfVuOverSpeedingEvents) OF VuOverSpeedingEventRecord*

}

**noOfVuOverSpeedingEvents** is the number of events listed in the *vuOverSpeedingEventRecords* set.

**vuOverSpeedingEventRecords** is a set of over speeding events records.

#### 2.141. VuOverSpeedingEventRecord

Information, stored in a vehicle unit, related to over speeding events (requirement 094).

*VuOverSpeedingEventRecord ::= SEQUENCE {*

*eventType EventFaultType,*

*eventRecordPurpose EventFaultRecordPurpose,*

*eventBeginTime TimeReal,*

*eventEndTime TimeReal,*

*maxSpeedValue SpeedMax,*

*averageSpeedValue SpeedAverage,*

*cardNumberDriverSlotBegin FullCardNumber,*

*similarEventsNumber SimilarEventsNumber*

}

**eventType** is the type of the event.

**eventRecordPurpose** is the purpose for which this event has been recorded.

**eventBeginTime** is the date and time of beginning of event.

**eventEndTime** is the date and time of end of event.

---

*Changes to legislation: There are currently no known outstanding effects for the Council Regulation (EEC) No 3821/85. (See end of Document for details)*

---

**maxSpeedValue** is the maximum speed measured during the event.

**averageSpeedValue** is the arithmetic average speed measured during the event.

**cardNumberDriverSlotBegin** identifies the card inserted in the driver slot at the beginning of the event.

**similarEventsNumber** is the number of similar events that day.

#### 2.142. VuPartNumber

Part number of the vehicle unit.

*VuPartNumber ::= IA5String(SIZE(16))*

**Value assignment:** VU manufacturer specific.

#### 2.143. VuPlaceDailyWorkPeriodData

Information, stored in a vehicle unit, related to places where drivers begin or end a daily work periods (requirement 087).

*VuPlaceDailyWorkPeriodData ::= SEQUENCE {*

*noOfPlaceRecords INTEGER(0..255),*

*vuPlaceDailyWorkPeriodRecords SET SIZE(noOfPlaceRecords) OF*

*VuPlaceDailyWorkPeriodRecord*

*}*

**noOfPlaceRecords** is the number of records listed in the vuPlaceDailyWorkPeriodRecords set.

**vuPlaceDailyWorkPeriodRecords** is a set of place related records.

#### 2.144. VuPlaceDailyWorkPeriodRecord

Information, stored in a vehicle unit, related to a place where a driver begins or ends a daily work period (requirement 087).

*VuPlaceDailyWorkPeriodRecord ::= SEQUENCE {*

*fullCardNumber FullCardNumber,*

*placeRecord PlaceRecord*

*}*

**fullCardNumber** is the driver's card type, card issuing Member State and card number.

**placeRecord** contains the information related to the place entered.

#### 2.145. VuPrivateKey

The private key of a vehicle unit.

*VuPrivateKey ::= RSAKeyPrivateExponent*

#### 2.146. VuPublicKey

The public key of a vehicle unit.

---

**Changes to legislation:** There are currently no known outstanding effects for the Council Regulation (EEC) No 3821/85. (See end of Document for details)

---

*VuPublicKey ::= PublicKey*

2.147. VuSerialNumber

Serial number of the vehicle unit (requirement 075).

*VuSerialNumber ::= ExtendedSerialNumber*

2.148. VuSoftInstallationDate

Date of installation of the vehicle unit software version.

*VuSoftInstallationDate ::= TimeReal*

**Value assignment:** Unspecified.

2.149. VuSoftwareIdentification

Information, stored in a vehicle unit, related to the software installed.

*VuSoftwareIdentification ::= SEQUENCE {*

*vuSoftwareVersion VuSoftwareVersion,*

*vuSoftInstallationDate VuSoftInstallationDate*

*}*

**vuSoftwareVersion** is the software version number of the Vehicle Unit.

**vuSoftInstallationDate** is the software version installation date.

2.150. VuSoftwareVersion

Software version number of the vehicle unit.

*VuSoftwareVersion ::= IA5String(SIZE(4))*

**Value assignment:** Unspecified.

2.151. VuSpecificConditionData

Information, stored in a vehicle unit, related to specific conditions.

*VuSpecificConditionData ::= SEQUENCE {*

*noOfSpecificConditionRecords INTEGER(0..2<sup>16</sup>-1)*

*specificConditionRecords SET SIZE (noOfSpecificConditionRecords) OF SpecificConditionRecord*

*}*

**noOfSpecificConditionRecords** is the number of records listed in the specificConditionRecords set.

**specificConditionRecords** is a set of specific conditions related records.

2.152. VuTimeAdjustmentData

Information, stored in a vehicle unit, related to time adjustments performed outside the frame of a regular calibration (requirement 101).

---

*Changes to legislation: There are currently no known outstanding effects for the Council Regulation (EEC) No 3821/85. (See end of Document for details)*

---

*VuTimeAdjustmentData ::= SEQUENCE {  
noOfVuTimeAdjRecords INTEGER(0..6),  
vuTimeAdjustmentRecords SET SIZE(noOfVuTimeAdjRecords) OF VuTimeAdjustmentRecord  
}*

**noOfVuTimeAdjRecords** is the number of records in vuTimeAdjustmentRecords.

**vuTimeAdjustmentRecords** is a set of time adjustment records.

#### 2.153. VuTimeAdjustmentRecord

Information, stored in a vehicle unit, related to a time adjustment performed outside the frame of a regular calibration (requirement 101).

*VuTimeAdjustmentRecord ::= SEQUENCE {  
[<sup>x3</sup> ..... ]*

#### **Editorial Information**

**X3** Deleted by [Corrigendum to Commission Regulation \(EC\) No 1360/2002 of 13 June 2002 adapting for the seventh time to technical progress Council Regulation \(EEC\) No 3821/85 on recording equipment in road transport \(Official Journal of the European Communities L 207 of 5 August 2002\)](#).

*oldTimeValue TimeReal,  
newTimeValue TimeReal,  
workshopName Name,  
workshopAddress Address,  
workshopCardNumber FullCardNumber  
}*

**oldTimeValue**, **newTimeValue** are the old and new values of date and time.

**workshopName**, **workshopAddress** are the workshop name and address.

**workshopCardNumber** identifies the workshop card used to perform the time adjustment.

#### 2.154. W-VehicleCharacteristicConstant

Characteristic coefficient of the vehicle (definition k)).

*W-VehicleCharacteristicConstant ::= INTEGER(0..2<sup>16</sup>-1)*

**Value assignment:** Impulses per kilometre in the operating range 0 to 64 255 pulses/km.

#### 2.155. WorkshopCardApplicationIdentification

Information, stored in a workshop card related to the identification of the application of the card (requirement 190).

*WorkshopCardApplicationIdentification ::= SEQUENCE {*

---

**Changes to legislation:** There are currently no known outstanding effects for the Council Regulation (EEC) No 3821/85. (See end of Document for details)

---

```

typeOfTachographCardId EquipmentType,
cardStructureVersion CardStructureVersion,
noOfEventsPerType NoOfEventsPerType,
noOfFaultsPerType NoOfFaultsPerType,
activityStructureLength CardActivityLengthRange,
noOfCardVehicleRecords NoOfCardVehicleRecords,
noOfCardPlaceRecords NoOfCardPlaceRecords,
noOfCalibrationRecords NoOfCalibrationRecords
}

```

**typeOfTachographCardId** is specifying the implemented type of card.

**cardStructureVersion** is specifying the the version of the structure that is implemented in the card.

**noOfEventsPerType** is the number of events per type of event the card can record.

**noOfFaultsPerType** is the number of faults per type of fault the card can record.

**activityStructureLength** indicates the number of bytes available for storing activity records.

**noOfCardVehicleRecords** is the number of vehicle records the card can contain.

**noOfCardPlaceRecords** is the number of places the card can record.

**noOfCalibrationRecords** is the number of calibration records the card can store.

#### 2.156. WorkshopCardCalibrationData

Information, stored in a workshop card, related to workshop activity performed with the card (requirements 227 and 229).

```

WorkshopCardCalibrationData ::= SEQUENCE {
calibrationTotalNumber INTEGER(0..216-1),
calibrationPointerNewestRecord INTEGER(0..NoOfCalibrationRecords-1),
calibrationRecords SET SIZE(NoOfCalibrationRecords) OF WorkshopCardCalibrationRecord
}

```

**calibrationTotalNumber** is the total number of calibrations performed with the card.

**calibrationPointerNewestRecord** is the index of the last updated calibration record.

**Value assignment:** Number corresponding to the numerator of the calibration record, beginning with '0' for the first occurrence of the calibration records in the structure.

**calibrationRecords** is the set of records containing calibration and/or time adjustment information.

#### 2.157. WorkshopCardCalibrationRecord

---

*Changes to legislation: There are currently no known outstanding effects for the Council Regulation (EEC) No 3821/85. (See end of Document for details)*

---

Information, stored in a workshop card, related to a calibration performed with the card (requirement 227).

```

WorkshopCardCalibrationRecord ::= SEQUENCE {
  calibrationPurpose CalibrationPurpose,
  vehicleIdentificationNumber VehicleIdentificationNumber,
  vehicleRegistration VehicleRegistrationIdentification,
  wVehicleCharacteristicConstant W-VehicleCharacteristicConstant,
  kConstantOfRecordingEquipment K-ConstantOfRecordingEquipment,
  lTyreCircumference L-TyreCircumference,
  tyreSize TyreSize,
  authorisedSpeed SpeedAuthorised,
  oldOdometerValue OdometerShort,
  newOdometerValue OdometerShort,
  oldTimeValue TimeReal,
  newTimeValue TimeReal,
  nextCalibrationDate TimeReal,
  vuPartNumber VuPartNumber,
  vuSerialNumber VuSerialNumber,
  sensorSerialNumber SensorSerialNumber
}

```

**calibrationPurpose** is the purpose of the calibration.

**vehicleIdentificationNumber** is the VIN.

**vehicleRegistration** contains the VRN and registering Member State.

**wVehicleCharacteristicConstant** is the characteristic coefficient of the vehicle.

**kConstantOfRecordingEquipment** is the constant of the recording equipment.

**lTyreCircumference** is the effective circumference of the wheel tyres.

**tyreSize** is the designation of the dimensions of the tyres mounted on the vehicle.

**authorisedSpeed** is the maximum authorised speed of the vehicle.

**oldOdometerValue**, **newOdometerValue** are the old and new values of the odometer.

**oldTimeValue**, **newTimeValue** are the old and new values of date and time.

**nextCalibrationDate** is the date of the next calibration of the type specified in CalibrationPurpose to be carried out by the authorised inspection authority.



---

**Changes to legislation:** There are currently no known outstanding effects for the Council Regulation (EEC) No 3821/85. (See end of Document for details)

---

**vuPartNumber**, **vuSerialNumber** and **sensorSerialNumber** are the data elements for recording equipment identification.

#### 2.158. WorkshopCardHolderIdentification

Information, stored in a workshop card, related to the identification of the cardholder (requirement 216).

```
WorkshopCardHolderIdentification ::= SEQUENCE {
workshopName Name,
workshopAddress Address,
cardHolderName HolderName,
cardHolderPreferredLanguage Language
}
```

**workshopName** is name of the workshop of the card holder.

**workshopAddress** is the address of the workshop of the card holder.

**cardHolderName** is the name and first name(s) of the holder (e.g. the name of the mechanic).

**cardHolderPreferredLanguage** is the preferred language of the card holder.

#### 2.159. WorkshopCardPIN

Personal identification number of the Workshop Card (requirement 213).

```
WorkshopCardPIN ::= IA5String(SIZE(8))
```

**Value assignment:** The PIN known to the cardholder, right padded with 'FF' bytes up to 8 bytes.

### 3. VALUE AND SIZE RANGE DEFINITIONS

Definition of variable values used for definitions in paragraph 2.

```
TimeRealRange ::= 232-1
```

#### 3.1. Definitions for the Driver Card:

Name of the variable value	Minimum	Maximum
<i>CardActivityLengthRange</i>	5 544 bytes (28 days 93 activity changes per day)	13 776 bytes (28 days 240 activity changes per day)
<i>NoOfCardPlaceRecords</i>	84	112
<i>NoOfCardVehicleRecords</i>	84	200
<i>NoOfEventsPerType</i>	6	12
<i>NoOfFaultsPerType</i>	12	24

#### 3.2. Definitions for the Workshop Card:

*Changes to legislation: There are currently no known outstanding effects for the Council Regulation (EEC) No 3821/85. (See end of Document for details)*

Name of the variable value	Minimum	Maximum
<i>CardActivityLengthRange</i>	198 bytes (1 day 93 activity changes)	492 bytes (1 day 240 activity changes)
<i>NoOfCardPlaceRecords</i>	6	8
<i>NoOfCardVehicleRecords</i>	4	8
<i>NoOfEventsPerType</i>	3	3
<i>NoOfFaultsPerType</i>	6	6
<i>NoOfCalibrationRecords</i>	88	255

### 3.3. Definitions for the Control Card:

Name of the variable value	Minimum	Maximum
<i>NoOfControlActivityRecords</i>	230	520

### 3.4. Definitions for the Company Card:

Name of the variable value	Minimum	Maximum
<i>NoOfCompanyActivityRecords</i>	230	520

## 4. CHARACTER SETS

IA5Strings use the ASCII characters as defined by ISO/IEC 8824-1. For readability and for easy referencing the value assignment is given below. The ISO/IEC 8824-1 supersedes this informative note in case of discrepancy.

!"#\$%&'()\*+,-./0123456789:;<=>?

@ABCDEFGHIJKLMN O PQRSTUVWXYZ[\]^\_

'abcdefghijklmnopqrstuvwxy z{|}~

<sup>[F15]</sup> Other character strings (Address, Name, VehicleRegistrationNumber) use, in addition, characters from the decimal character code range 161 – 255 of the following 8-bit, standard character sets, specified by the Code Page number:Standard Character Set	Code Page(Decimal)
ISO/IEC 8859-1 Latin-1 Western European	1
ISO/IEC 8859-2 Latin-2 Central European	2
ISO/IEC 8859-3 Latin-3 South European	3
ISO/IEC 8859-5 Latin / Cyrillic	5

---

**Changes to legislation:** There are currently no known outstanding effects for the Council Regulation (EEC) No 3821/85. (See end of Document for details)

---

ISO/IEC 8859-7 Latin / Greek	7
ISO/IEC 8859-9 Latin-5 Turkish	9
ISO/IEC 8859-13 Latin-7 Baltic Rim	13
ISO/IEC 8859-15 Latin-9	15
ISO/IEC 8859-16 Latin-10 South Eastern European	16
KOI8-R Latin / Cyrillic	80
KOI8-U Latin / Cyrillic	85]

## 5. ENCODING

When encoded with ASN.1 encoding rules, all data types defined shall be encoded according to ISO/IEC 8825-2, aligned variant.

---

*Changes to legislation: There are currently no known outstanding effects for the Council Regulation (EEC) No 3821/85. (See end of Document for details)*

---

## Appendix 2

### TACHOGRAPH CARDS SPECIFICATION

#### 1. INTRODUCTION

##### 1.1. Abbreviations

For the purpose of this appendix, the following abbreviations apply:

AC	access conditions
AID	application identifier
ALW	always
APDU	application protocol data unit (structure of a command)
ATR	answer to reset
AUT	authenticated
C6, C7	contacts No 6 and 7 of the card as described in ISO/IEC 7816-2
cc	clock cycles
CHV	card holder verification information
CLA	class byte of an APDU command
DF	dedicated file. A DF can contain other files (EF or DF)
EF	elementary file
ENC	encrypted: access is possible only by encoding data
etu	elementary time unit
IC	integrated circuit
ICC	integrated circuit card
ID	identifier
IFD	interface device
IFS	information field size
IFSC	information field size for the card
IFSD	information field size device (for the terminal)
INS	instruction byte of an APDU command
Lc	length of the input data for a APDU command
Le	length of the expected data (output data for a command)
MF	master file (root DF)
P1-P2	parameter bytes
NAD	node address used in T=1 protocol
NEV	never
PIN	personal identification number
PRO SM	protected with secure messaging
PTS	protocol transmission selection
RFU	reserved for future use
RST	reset (of the card)
SM	secure messaging
SW1-SW2	status bytes
TS	initial ATR character
VPP	programming voltage
XXh	value XX in hexadecimal notation
	concatenation symbol 03  04=0304.

##### 1.2. References

The following references are used in this Appendix:

**Changes to legislation:** There are currently no known outstanding effects for the Council Regulation (EEC) No 3821/85. (See end of Document for details)

EN 726-3	Identification cards systems — Telecommunications integrated circuit(s) cards and terminals — Part 3: Application independent card requirements. December 1994.
ISO/IEC 7816-2	Information technology — Identification cards — Integrated circuit(s) cards with contacts — Part 2: Dimensions and location of the contacts. First edition: 1999.
ISO/IEC 7816-3	Information technology — Identification cards — Integrated circuit(s) cards with contacts — Part 3: Electronic signals and transmission protocol. Edition 2: 1997.
ISO/IEC 7816-4	Information technology — Identification cards — Integrated circuit(s) cards with contacts — Part 4: Interindustry commands for interexchange. First edition: 1995 + Amendment 1: 1997.
ISO/IEC 7816-6	Information technology — Identification cards — Integrated circuit(s) cards with contacts — Part 6: Interindustry data elements. First Edition: 1996 + Cor 1: 1998.
ISO/IEC 7816-8	Information technology — Identification cards — Integrated circuit(s) cards with contacts — Part 8: Security related interindustry commands. First Edition: 1999.
ISO/IEC 9797	Information technology — Security techniques — Data integrity mechanism using a cryptographic check function employing a block cipher algorithm. Edition 2: 1994.

## 2. ELECTRICAL AND PHYSICAL CHARACTERISTICS

All electronic signals shall be in accordance with ISO/IEC 7816-3 unless specified otherwise.

The location and dimensions of the card contacts shall comply with the ISO/IEC 7816-2.

### 2.1. Supply voltage and current consumption

The card shall work according to specifications within the consumption limits specified in ISO/IEC 7816-3.

[<sup>XI</sup>The card shall work with  $V_{CC} = 3 \text{ V} (\pm 0,3 \text{ V})$  or with  $V_{CC} = 5 \text{ V} (\pm 0,5 \text{ V})$ .]

Voltage selection shall be performed according to ISO/IEC 7816-3.

### 2.2. Programming voltage $V_{pp}$

---

*Changes to legislation: There are currently no known outstanding effects for the Council Regulation (EEC) No 3821/85. (See end of Document for details)*

---

The card shall not require a programming voltage at pin C6. It is expected that pin C6 is not connected in an IFD. Contact C6 may be connected to  $V_{cc}$  in the card but shall not be connected to ground. This voltage should not be interpreted in any case.

### 2.3. Clock generation and frequency

The card shall operate within a frequency range of 1 to 5 MHz. Within one card session the clock frequency may vary  $\pm 2\%$ . The clock frequency is generated by the Vehicle Unit and not the card itself. The duty cycle may vary between 40 and 60 %.

Under conditions contained into the card file  $EF_{ICC}$ , the external clock can be stopped. The first byte of the  $EF_{ICC}$  file body codes the Clockstop mode conditions (see EN 726-3 for further details):

Low Bit 3	High Bit 2	Bit 1	
0	0	1	Clockstop allowed, no preferred level
0	1	1	Clockstop allowed, high level preferred
1	0	1	Clockstop allowed, low level preferred
0	0	0	Clockstop not allowed
0	1	0	Clockstop only allowed on high level
1	0	0	Clockstop only allowed on low level

Bits 4 to 8 are not used.

### 2.4. I/O contact

The I/O contact C7 is used to receive data from and to transmit data to the IFD. During operation only either the card or the IFD shall be in transmit mode. Should both units be in transmit mode no damage shall occur to the card. Unless transmitting, the card shall enter the reception mode.

### 2.5. States of the card

The card works in two states while the supply voltage is applied:

- operation state while executing commands or interfacing with Digital Unit,
- idle state at all other times; in this state all data shall be retained by the card.

## 3. HARDWARE AND COMMUNICATION

### 3.1. Introduction

This paragraph describes the minimum functionality required by Tachograph cards and VUs to ensure correct operation and interoperability.

Tachograph cards are as compliant as possible with the available ISO/IEC applicable norms (especially ISO/IEC 7816). However, commands and protocols are fully described in order to

specify some restricted usage or some differences if they exist. The commands specified are fully compliant with the referred norms except where indicated.

### 3.2. Transmission protocol

The Transmission protocol shall be compliant with ISO/IEC 7816-3. In particular, the VU shall recognise waiting time extensions sent by the card.

#### 3.2.1. Protocols

The card shall provide both protocol T=0 and protocol T=1.

T=0 is the default protocol, a PTS command is therefore necessary to change the protocol to T=1.

Devices shall support direct convention in both protocols: the direct convention is hence mandatory for the card.

The Information Field Size Card byte shall be presented at the ATR in character TA3. This value shall be at least 'F0h' (= 240 bytes).

The following restrictions apply to the protocols:

##### T=0

- The interface device shall support an answer on I/O after the rising edge of the signal on RST from 400 cc.
- The interface device shall be able to read characters separated with 12 etu.
- The interface device shall read an erroneous character and its repetition if separated with 13 etu. If an erroneous character is detected, the Error signal on I/O can occur between 1 etu and 2 etu. The device shall support a 1 etu delay.
- The interface device shall accept a 33 bytes ATR (TS+32)
- If TC1 is present in the ATR, the Extra Guard Time shall be present for characters sent by the interface device although characters sent by the card can still be separated with 12 etu. This is also true for the ACK character sent by the card after a P3 character emitted by the interface device.
- The interface device shall take into account a NUL character emitted by the card.
- The interface device shall accept the complementary mode for ACK.
- The get-response command cannot be used in chaining mode to get a data which length could exceed 255 bytes.

##### T=1

- NAD byte: not used (NAD shall be set to '00').
- S-block ABORT: not used.
- S-block VPP state error: not used.
- The total chaining length for a data field will not exceed 255 bytes (to be ensured by the IFD).
- The Information Field Size Device (IFSD) shall be indicated by the IFD immediately after the ATR: the IFD shall transmit the S-Block IFS request after the ATR and the card shall send back S-Block IFS. The recommended value for IFSD is 254 bytes.
- The card will not ask for an IFS readjustment.

#### 3.2.2. ATR

*Changes to legislation: There are currently no known outstanding effects for the Council Regulation (EEC) No 3821/85. (See end of Document for details)*

The device checks ATR bytes, according to ISO/IEC 7816-3. No verification shall be done on ATR Historical Characters.

#### EXAMPLE OF BASIC BIPROTOCOL ATR ACCORDING TO ISO/IEC 7816-3

Character	Value	Remarks
TS	'3Bh'	Indicates direct convention
T0	'85h'	TD1 present; 5 historical bytes are presents
TD1	'80h'	TD2 present; T=0 to be used
TD2	'11h'	TA3 present; T=1 to be used
TA3	'XXh' ([ <sup>X1</sup> at least] 'F0h')	Information Field Size Card (IFSC)
TH1 bis TH5	'XXh'	Historical characters
TCK	'XXh'	Check character (exclusive OR)

After the Answer To Reset (ATR), the Master File (MF) is implicitly selected and becomes the Current Directory.

#### 3.2.3. PTS

The default Protocol is T=0. To set the T=1 protocol, a PTS (also known as PPS) must be sent to the card by the device.

As both T=0 and T=1 protocols are mandatory for the card, the basic PTS for protocol switching is mandatory for the card.

The PTS can be used, as indicated in ISO/IEC 7816-3, to switch to higher baud rates than the default one proposed by the card in the ATR if any (TA(1) byte).

Higher baud rates are optional for the card.

If no other baud rate than the default one are supported (or if the selected baud rate is not supported), the card shall respond to the PTS correctly according to ISO/IEC 7816-3 by omitting the PPS1 byte.

Examples of basic PTS for protocol selection are the following:

Character	Value	Remarks
PPSS	'FFh'	The initiate character
PPS0	'00h' or '01h'	PPS1 to PPS3 are not present; '00h' to select T0, '01h' to select T1
PK	'XXh'	Check character: 'XXh' = 'FFh' if PPS0 = '00h' 'XXh' = 'FEh' if PPS0 = '01h'

#### 3.3. Access conditions (AC)



---

**Changes to legislation:** There are currently no known outstanding effects for the Council Regulation (EEC) No 3821/85. (See end of Document for details)

---

Access Conditions (AC) for the UPDATE\_BINARY and READ\_BINARY commands are defined for each Elementary File.

The AC of the current file must be met before accessing the file via these commands.

The definitions of the available access conditions are the following:

- ALW: The action is always possible and can be executed without any restriction.
- NEV: The action is never possible.
- AUT: The right corresponding a successful external authentication must be opened up (done by the EXTERNAL\_AUTHENTICATE command).
- PRO SM: Command must be transmitted with a cryptographic checksum using secure messaging (See Appendix 11).
- AUT and PRO SM (combined)

On the processing commands (UPDATE\_BINARY and READ\_BINARY), the following access conditions can be set in the card:

	UPDATE_BINARY	READ_BINARY
ALW	Yes	Yes
NEV	Yes	Yes
AUT	Yes	Yes
PRO SM	Yes	No
AUT and PRO SM	Yes	No

The PRO SM access condition is not available for the READ\_BINARY command. It means that the presence of a cryptographic checksum for a READ command is never mandatory. However, using the value 'OC' for the class, it is possible to use the READ\_BINARY command with secure messaging, as described in paragraph 3.6.2.

#### 3.4. Data encryption

When confidentiality of data to be read from a file needs to be protected, the file is marked as 'Encrypted'. Encryption is performed using secure messaging (See Appendix 11).

#### 3.5. Commands and error codes overview

Commands and file organisation are deduced from and complies with ISO/IEC 7816-4.

This section describes the following APDU command-response pairs:

Command	INS
SELECT FILE	A4
READ BINARY	B0
UPDATE BINARY	D6
GET CHALLENGE	84
VERIFY	20
GET RESPONSE	C0

*Changes to legislation: There are currently no known outstanding effects for the Council Regulation (EEC) No 3821/85. (See end of Document for details)*

PERFORM SECURITY OPERATION: VERIFY CERTIFICATE COMPUTE DIGITAL SIGNATURE VERIFY DIGITAL SIGNATURE HASH	2A
INTERNAL AUTHENTICATE	88
EXTERNAL AUTHENTICATE	82
MANAGE SECURITY ENVIRONMENT: SETTING A KEY	22
PERFORM HASH OF FILE	2A

The status word SW1 SW2 are returned in any response message and denote the processing state of the command.

SW1	SW2	Meaning
90	00	Normal processing
61	XX	Normal processing. XX = number of response bytes available
62	81	Warning processing. Part of returned data may be corrupted
63	CX	Wrong CHV (PIN). Remaining attempts counter provided by 'X'
64	00	Execution error — State of non-volatile memory unchanged. Integrity error
65	00	Execution error — State of non-volatile memory changed
65	81	Execution error — State of non-volatile memory changed — Memory failure
66	88	Securitywrong Cryptographic error checksum (during secure messaging) or wrong certificate (during certificate verification) or wrong cryptogram (during external authentication) or wrong signature (during signature verification)

**Changes to legislation:** There are currently no known outstanding effects for the Council Regulation (EEC) No 3821/85. (See end of Document for details)

67	00	Wrong length (wrong Lc or Le)
69	00	Forbidden command (no response available in T=0)
69	82	Security status not satisfied
69	83	Authentication method blocked
69	85	Conditions of use not satisfied
69	86	Command not allowed (no current EF)
69	87	Expected secure messaging data objects missing
69	88	Incorrect secure messaging data objects
6A	82	File not found
6A	86	Wrong parameters P1-P2
6A	88	Referenced data not found
6B	00	Wrong parameters (offset outside the EF)
6C	XX	Wrong length, SW2 indicates the exact length. No data field is returned
6D	00	Instruction code not supported or invalid
6E	00	Class not supported
6F	00	Other checking errors

### 3.6. Commands description

The mandatory commands for the Tachograph cards are described in this chapter.

Additional relevant details, related to cryptographic operations involved, are given in Appendix 11 Common security mechanisms.

All commands are described independently of the used protocol (T=0 or T=1). The APDU bytes CLA, INS, P1, P2, Lc and Le are always indicated. If Lc or Le is not needed for the described command, the associated length, value and description are empty.

If both length bytes (Lc and Le) are requested, the described command has to be split in two parts if the IFD is using protocol T=0: the IFD sends the command as described with P3=Lc + data and then sends a GET\_RESPONSE (see point 3.6.6) command with P3=Le.

If both length bytes are requested, and Le=0 (secure messaging):

*Changes to legislation: There are currently no known outstanding effects for the Council Regulation (EEC) No 3821/85. (See end of Document for details)*

- When using protocol T=1, the card shall answer to Le=0 by sending all available output data.
- When using protocol T=0, the IFD shall send the first command with P3=Lc + data, the card shall answer (to this implicit Le=0) by the Status bytes '61La', where La is the number of response bytes available. The IFD shall then generate a GET RESPONSE command with P3=La to read the data.

### 3.6.1. Select file

This command is compliant with ISO/IEC 7816-4, but has a restricted usage compared to the command defined in the norm.

The SELECT FILE command is used:

- to select an application DF (selection by name must be used)
- to select an elementary file corresponding to the submitted file ID

#### 3.6.1.1. Selection by name (AID)

This command allows to select an application DF in the card.

This command can be performed from anywhere in the file structure (after the ATR or at anytime).

The selection of an application resets the current security environment. After performing the application selection, no current public key is selected anymore and the former session key is no longer available for secure messaging. The AUT access condition is also lost.

### COMMAND MESSAGE

Byte	Length	Value	Description
CLA	1	'00h'	
INS	1	'A4h'	
P1	1	'04h'	Selection by name (AID)
P2	1	'0Ch'	No response expected
Lc	1	'NNh'	Number of bytes sent to the card (length of the AID): '06h' for the Tachograph application
#6-#(5+NN)	NN	'XX..XXh'	AID: 'FF 54 41 43 48 4F' for the Tachograph application

No response to the SELECT FILE command is needed (Le absent in T=1, or no response asked in T=0).

### RESPONSE MESSAGE (NO RESPONSE ASKED)

Byte	Length	Value	Description
------	--------	-------	-------------

**Changes to legislation:** There are currently no known outstanding effects for the Council Regulation (EEC) No 3821/85. (See end of Document for details)

SW	2	'XXXXh'	Status Words (SW1, SW2)
----	---	---------	-------------------------

- If the command is successful, the card returns '9000',
- if the application corresponding with the AID is not found, the processing state returned is '6A82',
- in T=1, if the byte Le is present, the state returned is '6700',
- in T=0, if a response is asked after the SELECT FILE command, the state returned is '6900',
- if the selected application is considered corrupted (integrity error is detected within the file attributes), the processing state returned is '6400' or '6581'.

### 3.6.1.2. Selection of an elementary file using its file identifier

#### COMMAND MESSAGE

Byte	Length	Value	Description
CLA	1	'00h'	
INS	1	'A4h'	
P1	1	'02h'	Selection of an EF under the current DF
P2	1	'0Ch'	No response expected
Lc	1	'02h'	Number of bytes sent to the card
#6-#7	2	'XXXXh'	File Identifier

No response to the SELECT FILE command is needed (Le absent in T=1, or no response asked in T=0).

#### RESPONSE MESSAGE (NO RESPONSE ASKED)

Byte	Length	Value	Description
SW	2	'XXXXh'	Status Words (SW1, SW2)

- If the command is successful, the card returns '9000',
- if the file corresponding with the file identifier is not found, the processing state returned is '6A82',
- in T=1, if the byte Le is present, the state returned is '6700',
- in T=0, if a response is asked after the SELECT FILE command, the state returned is '6900',
- if the selected file is considered corrupted (integrity error is detected within the file attributes), the processing state returned is '6400' or '6581'.

### 3.6.2. Read Binary

This command is compliant with ISO/IEC 7816-4, but has a restricted usage compared to the command defined in the norm.

*Changes to legislation: There are currently no known outstanding effects for the Council Regulation (EEC) No 3821/85. (See end of Document for details)*

The Read Binary command is used to read data from a transparent file.

The response of the card consists of returning the data read, optionally encapsulated in a secure messaging structure.

The command can be performed only if the security status satisfies the security attributes defined for the EF for the READ function.

#### 3.6.2.1. Command without secure messaging

This command enables the IFD to read data from the EF currently selected, without secure messaging.

Reading data from a file marked as 'Encrypted' shall not be possible through this command.

#### COMMAND MESSAGE

Byte	Length	Value	Description
CLA	1	'00h'	No secure messaging asked
INS	1	'B0h'	
P1	1	'XXh'	Offset in bytes from the beginning of the file: most significant byte
P2	1	'XXh'	Offset in bytes from the beginning of the file: least significant byte
Le	1	'XXh'	Length of data expected. number of bytes to be read

Note: bit 8 of P1 must be set to 0.

#### RESPONSE MESSAGE

Byte	Length	Value	Description
#1-#X	X	'XX..XXh'	Data read
SW	2	'XXXXh'	Status words (SW1, SW2)

- If the command is successful, the card returns '9000',
- if no EF is selected, the processing state returned is '6986',
- if the Access Control of the selected file are not satisfied, the command is interrupted with '6982',
- if the Offset is not compatible with the size of the EF (Offset > EF size), the processing state returned is '6B00',

**Changes to legislation:** There are currently no known outstanding effects for the Council Regulation (EEC) No 3821/85. (See end of Document for details)

- if the size of the data to be read is not compatible with the size of the EF (Offset + Le > EF size) the processing state returned is '6700' or '6Cxx', where 'xx' indicates the exact length,
- if an integrity error is detected within the file attributes, the card shall consider the file as corrupted and unrecoverable, the processing state returned is '6400' or '6581',
- if an integrity error is detected within the stored data, the card shall return the demanded data, and the processing state returned is '6281'.

### 3.6.2.2. Command with secure messaging

This command enables the IDF to read data from the EF currently selected with secure messaging, in order to verify the integrity of the data received and to protect the confidentiality of the data in the case the EF is marked as 'Encrypted'.

#### COMMAND MESSAGE

Byte	Length	Value	Description
CLA	1	'0Ch'	Secure Messaging asked
INS	1	'B0h'	INS
P1	1	'XXh'	P1 (offset in bytes from the beginning of the file): Most Significant Byte
P2	1	'XXh'	P2 (offset in bytes from the beginning of the file): Least Significant Byte
Lc	1	'09h'	Length of input data for secure messaging
#6	1	'97h'	T <sub>LE</sub> : Tag for expected length specification
#7	1	'01h'	L <sub>LE</sub> : Length of expected length
#8	1	'NNh'	Expected length specification (original Le): Number of Bytes to be read
#9	1	'8Eh'	T <sub>CC</sub> : Tag for cryptographic checksum
#10	1	'04h'	L <sub>CC</sub> : Length of following cryptographic checksum

*Changes to legislation: There are currently no known outstanding effects for the Council Regulation (EEC) No 3821/85. (See end of Document for details)*

#11-#14	4	'XX..XXh'	Cryptographic checksum (4 most significant bytes)
Le	1	'00h'	As specified in ISO/IEC 7816-4

Response Message if EF is not marked as 'Encrypted' and if Secure Messaging input format is correct:

Byte	Length	Value	Description
#1	1	'81h'	T <sub>PV</sub> : Tag for plain value data
#2	L	'NNh' or '81 NNh'	L <sub>PV</sub> : length of returned data (= original Le) L is 2 bytes if L <sub>PV</sub> > 127 bytes
#(2+L)-#(1+L+NN)	NN	'XX..XXh'	Plain Data value
#(2+L+NN)	1	'8Eh'	T <sub>CC</sub> : Tag for cryptographic checksum
#(3+L+NN)	1	'04h'	L <sub>CC</sub> : Length of following cryptographic checksum
#(4+L+NN)-#(7+L+NN)	4	'XX..XXh'	Cryptographic checksum (4 most significant bytes)
SW	2	'XXXXh'	Status Words (SW1, SW2)

Response Message if EF is marked as 'Encrypted' and if Secure Messaging input format is correct:

Byte	Length	Value	Description
#1	1	'87h'	T <sub>PI CG</sub> : Tag for encrypted data (cryptogram)
#2	L	'MMh' or '81 MMh'	L <sub>PI CG</sub> : length of returned encrypted data (different of original Le of the command due to padding) L is 2 byte if L <sub>PI CG</sub> > 127 bytes



**Changes to legislation:** There are currently no known outstanding effects for the Council Regulation (EEC) No 3821/85. (See end of Document for details)

#(2+L)-#(1+L+MM)	MM	'01XX..XXh'	Encrypted data: padding indicator and cryptogram
#(2+L+MM)	1	'8Eh'	T <sub>CC</sub> : tag for cryptographic checksum
#(3+L+MM)	1	'04h'	L <sub>CC</sub> : length of following cryptographic checksum
#(4+L+MM)-#(7+L +MM)	4	'XX..XXh'	Cryptographic checksum (4 most significant bytes)
SW	2	'XXXXh'	Status words (SW1, SW2)

The encrypted data returned contain a first byte indicating the used padding mode. For the tachograph application, the padding indicator always takes the value '01h', indicating that the used padding mode is the one specified in ISO/IEC 7816-4 (one byte with value '80h' followed by some null bytes: ISO/IEC 9797 method 2).

The 'regular' processing states, described for the READ BINARY command with no secure messaging (see point 3.6.2.1), can be returned using the response message structures described above, under a '99h' Tag (as described in TCS 335).

Additionally, some errors specifically related to secure messaging can happen. In that case, the processing state is simply returned, with no secure messaging structure involved:

#### RESPONSE MESSAGE IF INCORRECT SECURE MESSAGING INPUT FORMAT

Byte	Length	Value	Description
SW	2	'XXXXh'	Status words (SW1, SW2)

- If no current session key is available, the processing state '6A88' is returned. It happens either if the session key has not already been generated or if the session key validity has expired (in this case the IFD must re-run a mutual authentication process to set a new session key).
- If some expected data objects (as specified above) are missing in the secure messaging format, the processing state '6987' is returned: this error happens if an expected tag is missing or if the command body is not properly constructed.
- If some data objects are incorrect, the processing state returned is '6988': this error happens if all the required tags are present but some lengths are different from the ones expected.
- If the verification of the cryptographic checksum fails, the processing state returned is '6688'.

#### 3.6.3. Update Binary

*Changes to legislation: There are currently no known outstanding effects for the Council Regulation (EEC) No 3821/85. (See end of Document for details)*

This command is compliant with ISO/IEC 7816-4, but has a restricted usage compared to the command defined in the norm.

The UPDATE BINARY command message initiates the update (erase + write) of the bits already present in an EF binary with the bits given in the command APDU.

The command can be performed only if the security status satisfies the security attributes defined for the EF for the UPDATE function (If the access control of the UPDATE function includes PRO SM, a secure messaging must be added in the command).

#### 3.6.3.1. Command without secure messaging

This command enables the IFD to write data into the EF currently selected, without the card verifying the integrity of data received. This plain mode is allowed only if the related file is not marked as 'Encrypted'.

#### COMMAND MESSAGE

Byte	Length	Value	Description
CLA	1	'00h'	No secure messaging asked
INS	1	'D6h'	
P1	1	'XXh'	Offset in bytes from the beginning of the file: most significant byte
P2	1	'XXh'	Offset in bytes from the beginning of the file: least significant byte
Lc	1	'NNh'	Lc length of data to Update. Number of bytes to be written
#6-#(5+NN)	NN	'XX..XXh'	Data to be written

Note: bit 8 of P1 must be set to 0.

#### RESPONSE MESSAGE

Byte	Length	Value	Description
SW	2	'XXXXh'	Status words (SW1, SW2)

- If the command is successful, the card returns '9000',
- if no EF is selected, the processing state returned is '6986',
- if the Access Control of the selected file are not satisfied, the command is interrupted with '6982',
- if the Offset is not compatible with the size of the EF (Offset > EF size), the processing state returned is '6B00',

**Changes to legislation:** There are currently no known outstanding effects for the Council Regulation (EEC) No 3821/85. (See end of Document for details)

- if the size of the data to be written is not compatible with the size of the EF [ $F^{22}$ (Offset + Lc > EF size)] the processing state returned is '6700',
- if an integrity error is detected within the file attributes, the card shall consider the file as corrupted and unrecoverable, the processing state returned is '6400' or '6500',
- if writing is unsuccessful, the processing state returned is '6581'.

### 3.6.3.2. Command with secure messaging

This command enables the IFD to write data into the EF currently selected, with the card verifying the integrity of data received. As no confidentiality is required, the data are not encrypted.

#### COMMAND MESSAGE

Byte	Length	Value	Description
CLA	1	'0Ch'	Secure messaging. Asked
INS	1	'D6h'	INS
P1	1	'XXh'	Offset in bytes from the beginning of the file: most significant byte
P2	1	'XXh'	Offset in bytes from the beginning of the file: least significant byte
Lc	1	'XXh'	Length of the secured data field
#6	1	'81h'	T <sub>PV</sub> : tag for plain value data
#7	L	'NNh' or '81 NNh'	L <sub>PV</sub> : length of transmitted data L is 2 bytes if L <sub>PV</sub> > 127 bytes
#(7+L)-#(6+L+NN)	NN	'XX..XXh'	Plain data value (data to be written)
#(7+L+NN)	1	'8Eh'	T <sub>CC</sub> : tag for cryptographic checksum
#(8+L+NN)	1	'04h'	L <sub>CC</sub> : Length of following cryptographic checksum
#(9+L+NN)-#(12+L+NN)	4	'XX..XXh'	Cryptographic checksum (4 most significant bytes)

*Changes to legislation: There are currently no known outstanding effects for the Council Regulation (EEC) No 3821/85. (See end of Document for details)*

Le	1	'00h'	As specified in ISO/IEC 7816-4
----	---	-------	--------------------------------

#### RESPONSE MESSAGE IF CORRECT SECURE MESSAGING INPUT FORMAT

Byte	Length	Value	Description
#1	1	'99h'	T <sub>SW</sub> : tag for status words (to be protected by CC)
#2	1	'02h'	L <sub>SW</sub> : length of returned status words
#3-#4	2	'XXXXh'	Status words (SW1, SW2)
#5	1	'8Eh'	T <sub>CC</sub> : tag for cryptographic checksum
#6	1	'04h'	L <sub>CC</sub> : Length of following cryptographic checksum
#7-#10	4	'XX..XXh'	Cryptographic checksum (4 most significant bytes)
SW	2	'XXXXh'	Status words (SW1, SW2)

The 'regular' processing states, described for the UPDATE BINARY command with no secure messaging (see point 3.6.3.1), can be returned using the response message structure described above.

Additionally, some errors specifically related to secure messaging can happen. In that case, the processing state is simply returned, with no secure messaging structure involved:

#### RESPONSE MESSAGE IF ERROR IN SECURE MESSAGING

Byte	Length	Value	Description
SW	2	'XXXXh'	Status Words (SW1, SW2)

- If no current session key is available, the processing state '6A88' is returned,
- if some expected data objects (as specified above) are missing in the secure messaging format, the processing state '6987' is returned: this error happens if an expected tag is missing or if the command body is not properly constructed,
- if some data objects are incorrect, the processing state returned is '6988': this error happens if all the required tags are present but some lengths are different from the ones expected,

---

**Changes to legislation:** There are currently no known outstanding effects for the Council Regulation (EEC) No 3821/85. (See end of Document for details)

---

- if the verification of the cryptographic checksum fails, the processing state returned is '6688'.

#### 3.6.4. Get challenge

This command is compliant with ISO/IEC 7816-4, but has a restricted usage compared to the command defined in the norm.

The GET CHALLENGE command asks the card to issue a challenge in order to use it in a security related procedure in which a cryptogram or some ciphered data are sent to the card.

The Challenge issued by the card is only valid for the next command, which uses a challenge, sent to the card.

#### COMMAND MESSAGE

Byte	Length	Value	Description
CLA	1	'00h'	CLA
INS	1	'84h'	INS
P1	1	'00h'	P1
P2	1	'00h'	P2
Le	1	'08h'	Le (Length of challenge expected)

#### RESPONSE MESSAGE

Byte	Length	Value	Description
#1-#8	8	'XX..XXh'	Challenge
SW	2	'XXXXh'	Status words (SW1, SW2)

- If the command is successful, the card returns '9000',
- if Le is different from '08h', the processing state is '6700',
- if parameters P1-P2 are incorrect, the processing state is '6A86'.

#### 3.6.5. Verify

This command is compliant with ISO/IEC 7816-4, but has a restricted usage compared to the command defined in the norm.

The Verify command initiates the comparison in the card of the CHV (PIN) data sent from the command with the reference CHV stored in the card.

Note: The PIN entered by the user must be right padded with FFh' bytes up to a length of 8 bytes by the IFD.

If the command is successful, the rights corresponding to CHV presentation are opened and the remaining CHV attempt counter is reinitialised.

An unsuccessful comparison is recorded in the card in order to limit the number of further attempts of the use of the reference CHV.

*Changes to legislation: There are currently no known outstanding effects for the Council Regulation (EEC) No 3821/85. (See end of Document for details)*

### COMMAND MESSAGE

Byte	Length	Value	Description
CLA	1	'00h'	CLA
INS	1	'20h'	INS
P1	1	'00h'	P1
P2	1	'00h'	P2 (the verified CHV is implicitly known)
Lc	1	'08h'	Length of CHV code transmitted
#6-#13	8	'XX...XXh'	CHV

### RESPONSE MESSAGE

Byte	Length	Value	Description
SW	2	'XXXXh'	Status words (SW1, SW2)

- If the command is successful, the card returns '9000',
- if the reference CHV is not found, the processing state returned is '6A88',
- if the CHV is blocked, (the remaining attempt counter of the CHV is null), the processing state returned is '6983'. Once in that state, the CHV can never be successfully presented anymore,
- if the comparison is unsuccessful, the remaining attempt Counter is decreased and the status '63CX' is returned (X > 0, and X equals the remaining CHV attempts counter. X = 'F', the CHV attempts counter is greater than 'F'),
- if the reference CHV is considered corrupted, the processing state returned is '6400' or '6581'.

#### 3.6.6. Get response

This command is compliant with ISO/IEC 7816-4.

This command (only necessary and available for T=0 Protocol) is used to transmit prepared data from the card to the interface device (case where a command had included both Lc and Le).

The GET\_RESPONSE command has to be issued immediately after the command preparing the data, otherwise, the data are lost. After the execution of the GET\_RESPONSE command (except if the error '61xx' or '6Cxx' occur, see below), the previously prepared data are no longer available.

### COMMAND MESSAGE

Byte	Length	Value	Description
CLA	1	'00h'	
INS	1	'C0h'	
P1	1	'00h'	

**Changes to legislation:** There are currently no known outstanding effects for the Council Regulation (EEC) No 3821/85. (See end of Document for details)

P2	1	'00h'	
Le	1	'XXh'	Number of bytes expected

#### RESPONSE MESSAGE

Byte	Length	Value	Description
#1-#X	X	'XX..XXh'	Data
SW	2	'XXXXh'	Status words (SW1, SW2)

- If the command is successful, the card returns '9000'.
- If no data have been prepared by the card, the processing state returned is '6900' or '6F00'.
- If Le exceeds the number of available bytes or if Le is null, the processing state returned is '6Cxx', where 'xx' denotes the exact number of available bytes. In that case, the prepared data are still available for a subsequent GET\_RESPONSE command.
- If Le is not null and is smaller than the number of available bytes, the required data are sent normally by the card, and the processing state returned is '61xx', where 'xx' indicates a number of extra bytes still available by a subsequent GET\_RESPONSE command.
- If the command is not supported (protocol T=1), the card returns '6D00'.

#### 3.6.7. PSO: verify certificate

This command is compliant with ISO/IEC 7816-8, but has a restricted usage compared to the command defined in the norm.

The VERIFY CERTIFICATE command is used by the card to obtain a Public Key from the outside and to check its validity.

When a VERIFY CERTIFICATE command is successful, the Public Key is stored for a future use in the Security environment. This key shall be explicitly set for the use in security related commands (INTERNAL AUTHENTICATE, EXTERNAL AUTHENTICATE or VERIFY CERTIFICATE) by the MSE command (see point 3.6.10) using its key identifier.

In any case, the VERIFY CERTIFICATE command uses the public key previously selected by the MSE command to open the certificate. This public key must be the one of a Member State or of Europe.

#### COMMAND MESSAGE

Byte	Length	Value	Description
CLA	1	'00h'	CLA
INS	1	'2Ah'	Perform Security Operation
P1	1	'00h'	P1
P2	1	'AEh'	P2: non BER-TLV coded data

**Changes to legislation:** There are currently no known outstanding effects for the Council Regulation (EEC) No 3821/85. (See end of Document for details)

			(concatenation of data elements)
Lc	1	'[F <sup>22</sup> C2h]'	Lc: Length of the certificate, 194 bytes
#6-#199	194	'XX..XXh'	Certificate: concatenation of data elements (as described in Appendix 11)

#### RESPONSE MESSAGE

Byte	Length	Value	Description
SW	2	'XXXXh'	Status words (SW1, SW2)

- If the command is successful, the card returns '9000',
- if the certificate verification fails, the processing state returned is '6688'. The verification and unwrapping process of the certificate is described in Appendix 11,
- if no Public Key is present in the Security Environment, '6A88' is returned,
- if the selected public key (used to unwrap the certificate) is considered corrupted, the processing state returned is '6400' or '6581',
- if the selected public key (used to unwrap the certificate) has a CHA.LSB (*CertificateHolderAuthorisation.equipmentType*) different from '00' (i.e. is not the one of a Member State or of Europe), the processing state returned is '6985'.

#### 3.6.8. Internal authenticate

This command is compliant with ISO/IEC 7816-4.

Using the INTERNAL AUTHENTICATE command, the IFD can authenticate the card.

The authentication process is described in Appendix 11. It includes the following statements:

The INTERNAL AUTHENTICATE command uses the card Private Key (implicitly selected) to sign authentication data including K1 (first element for session key agreement) and RND1, and uses the Public Key currently selected (through the last MSE command) to encrypt the signature and form the authentication token (more details in Appendix 11).

#### COMMAND MESSAGE

Byte	Length	Value	Description
CLA	1	'00h'	CLA
INS	1	'88h'	INS
P1	1	'00h'	P1
P2	1	'00h'	P2
Lc	1	'10h'	Length of data sent to the card



**Changes to legislation:** There are currently no known outstanding effects for the Council Regulation (EEC) No 3821/85. (See end of Document for details)

#6-#13	8	'XX..XXh'	Challenge used to authenticate the card
#14-#21	8	'XX..XXh'	VU.CHR (see Appendix 11)
Le	1	'80h'	Length of the data expected from the card

#### RESPONSE MESSAGE

Byte	Length	Value	Description
#1-#128	128	'XX..XXh'	Card authentication token (see Appendix 11)
SW	2	'XXXXh'	Status words (SW1, SW2)

- If the command is successful, the card returns '9000',
- if no Public Key is present in the Security Environment, the processing state returned is '6A88',
- if no Private Key is present in the Security Environment, the processing state returned is '6A88',
- if VU.CHR does not match the current public key identifier, the processing state returned is '6A88',
- if the selected private key is considered corrupted, the processing state returned is '6400' or '6581'.

If the INTERNAL\_AUTHENTICATE command is successful, the current session key, if existing, is erased and no longer available. In order to have a new session key available, the EXTERNAL\_AUTHENTICATE command must be successfully performed.

#### 3.6.9. External authenticate

This command is compliant with ISO/IEC 7816-4.

Using the EXTERNAL AUTHENTICATE command, the card can authenticate the IFD.

The authentication process is described in Appendix 11. It includes the following statements:

A GET CHALLENGE command must precede the EXTERNAL\_AUTHENTICATE command immediately. The card issues a challenge to the outside (RND3).

The verification of the cryptogram uses RND3 (challenge issued by the card), the card private key (implicitly selected) and the public key previously selected by the MSE command.

The card verifies the cryptogram, and if it is correct, the AUT access condition is opened.

[<sup>X1</sup>The input cryptogram carries the second element for session key agreement K2.]

#### COMMAND MESSAGE

Byte	Length	Value	Description
------	--------	-------	-------------

*Changes to legislation: There are currently no known outstanding effects for the Council Regulation (EEC) No 3821/85. (See end of Document for details)*

CLA	1	'00h'	CLA
INS	1	'82h'	INS
P1	1	'00h'	P1
P2	1	'00h'	P2 (the public key to be used is implicitly known, and has been previously set by the MSE command)
Lc	1	'80h'	Lc (Length of the data sent to the card)
#6-#133	128	'XX..XXh'	Cryptogram (see Appendix 11)

#### RESPONSE MESSAGE

Byte	Length	Value	Description
SW	2	'XXXXh'	Status words (status words (SW1, SW2))

- If the command is successful, the card returns '9000',
- if no Public Key is present in the Security Environment, '6A88' is returned,
- if the CHA of the currently set public key is not the concatenation of the Tachograph application AID and of a VU equipment Type, the processing state returned is '6F00' (see Appendix 11),
- if no Private Key is present in the Security Environment, the processing state returned is '6A88',
- if the verification of the cryptogram is wrong, the processing state returned is '6688',
- if the command is not immediately preceded with a GET CHALLENGE command, the processing state returned is '6985',
- if the selected private key is considered corrupted, the processing state returned is '6400' or '6581'.

If the EXTERNAL AUTHENTICATE command is successful, and if the first part of the session key is available from a successful INTERNAL AUTHENTICATE recently performed, the session key is set for future commands using secure messaging.

If the first session key part is not available from a previous INTERNAL AUTHENTICATE command, the second part of the session key, sent by the IFD, is not stored in the card. This mechanism ensures that the mutual authentication process is done in the order specified in Appendix 11.

#### 3.6.10. Manage security environment

This command is used to set a public key for authentication purpose.

This command is compliant with ISO/IEC 7816-8. The use of this command is restricted regarding the related standard.

The key referenced in the MSE data field is valid for every file of the Tachograph DF.

**Changes to legislation:** There are currently no known outstanding effects for the Council Regulation (EEC) No 3821/85. (See end of Document for details)

The key referenced in the MSE data field remains the current public key until the next correct MSE command.

If the key referenced is not (already) present into the card, the security environment remains unchanged.

#### COMMAND MESSAGE

Byte	Length	Value	Description
CLA	1	'00h'	CLA
INS	1	'22h'	INS
P1	1	'C1h'	P1: referenced key valid for all cryptographic operations
P2	1	'B6h'	P2 (referenced data concerning digital signature)
Lc	1	'0Ah'	Lc: length of subsequent data field
#6	1	'83h'	Tag for referencing a public key in asymmetric cases
#7	1	'08h'	Length of the key reference (key identifier)
#8-#15	08h	'XX..XXh'	Key identifier as specified in Appendix 11

#### RESPONSE MESSAGE

Byte	Length	Value	Description
SW	2	'XXXXh'	Status words (SW1, SW2)

- If the command is successful, the card returns '9000',
- if the referenced key is not present into the card, the processing state returned is '6A88',
- if some expected data objects are missing in the secure messaging format, the processing state '6987' is returned. This can happen if the tag '83h' is missing,
- if some data objects are incorrect, the processing state returned is '6988'. This can happen if the length of the key identifier is not '08h',
- if the selected key is considered corrupted, the processing state returned is '6400' or '6581'.

#### 3.6.11. PSO: hash

*Changes to legislation: There are currently no known outstanding effects for the Council Regulation (EEC) No 3821/85. (See end of Document for details)*

This command is used to transfer to the card the result of a hash calculation on some data. This command is used for the verification of digital signatures. The hash value is stored in EEPROM for the subsequent command verify digital signature.

This command is compliant with ISO/IEC 7816-8. The use of this command is restricted regarding the related standard.

#### COMMAND MESSAGE

Byte	Length	Value	Description
CLA	1	'00h'	CLA
INS	1	'2Ah'	Perform security operation
P1	1	'90h'	Return hash code
P2	1	'A0h'	Tag: data field contains DOs relevant for hashing
Lc	1	'16h'	Length Lc of the subsequent data field
#6	1	'90h'	Tag for the hash code
#7	1	'14h'	Length of the hash code
#8-#27	20	'XX..XXh'	Hash code

#### RESPONSE MESSAGE

Byte	Length	Value	Description
SW	2	'XXXXh'	Status words (SW1, SW2)

- If the command is successful, the card returns '9000',
- if some expected data objects (as specified above) are missing, the processing state '6987' is returned. This can happen if one of the tag '90h' is missing,
- if some data objects are incorrect, the processing state returned is '6988'. This error happens if the required tag is present but with a length different from '14h'.

#### 3.6.12. Perform hash of file

This command is not compliant with ISO/IEC 7816-8. Thus the CLA byte of this command indicates that there is a proprietary use of the PERFORM SECURITY OPERATION/HASH.

The perform hash file command is used to hash the data area of the currently selected transparent EF.

The result of the hash operation is stored in the card. It can then be used to get a digital signature of the file, using the PSO-COMPUTE\_DIGITAL\_SIGNATURE command. This result remains available for the COMPUTE DIGITAL SIGNATURE command until the next successful PERFORM HASH of FILE command.

**Changes to legislation:** There are currently no known outstanding effects for the Council Regulation (EEC) No 3821/85. (See end of Document for details)

## COMMAND MESSAGE

Byte	Length	Value	Description
CLA	1	'80h'	CLA
INS	1	'2Ah'	Perform security operation
P1	1	'90h'	Tag: hash
P2	1	'00h'	P2: hash the data of the currently selected transparent file

## RESPONSE MESSAGE

Byte	Length	Value	Description
SW	2	'XXXXh'	Status words (SW1, SW2)

- If the command is successful, the card returns '9000',
- if no application is selected, the processing state '6985' is returned,
- if the selected EF is considered corrupted (file attributes or stored data integrity errors), the processing state returned is '6400' or '6581',
- if the selected file is not a transparent file, the processing state returned is '6986'.

## 3.6.13. PSO: compute digital signature

This command is used to compute the digital signature of previously computed hash code (see PERFORM HASH of FILE, point 3.6.12).

This command is compliant with ISO/IEC 7816-8. The use of this command is restricted regarding the related standard.

The card private key is used to compute the digital signature and is implicitly known by the card.

The card performs a digital signature using a padding method compliant with PKCS1 (see Appendix 11 for details).

## COMMAND MESSAGE

Byte	Length	Value	Description
CLA	1	'00h'	CLA
INS	1	'2Ah'	Perform security operation
P1	1	'9Eh'	Digital signature to be returned
P2	1	'9Ah'	Tag: data field contains data to be signed. As no data field is included, the data are supposed to

*Changes to legislation: There are currently no known outstanding effects for the Council Regulation (EEC) No 3821/85. (See end of Document for details)*

			be already present in the card (hash of file)
Le	1	'80h'	Length of the expected signature

#### RESPONSE MESSAGE

Byte	Length	Value	Description
#1-#128	128	'XX..XXh'	Signature of the previously computed hash
SW	2	'XXXXh'	Status words (SW1, SW2)

- If the command is successful, the card returns '9000',
- if the implicitly selected private key is considered as corrupted, the processing state returned is '6400' or '6581'.

#### 3.6.14. PSO: verify digital signature

This command is used to verify the digital signature, provided as an input, in accordance with PKCS1 of a message, whose hash is known to the card. The signature algorithm is implicitly known by the card.

This command is compliant with ISO/IEC 7816-8. The use of this command is restricted regarding the related standard.

The Verify Digital Signature command always uses the public key selected by the previous Manage Security Environment command, and the previous hash code entered by a PSO: hash command.

#### COMMAND MESSAGE

Byte	Length	Value	Description
CLA	1	'00h'	CLA
INS	1	'2Ah'	Perform security operation
P1	1	'00h'	
P2	1	'A8h'	Tag: data field contains DOs relevant for verification
Lc	1	'83h'	Length Lc of the subsequent data field
#28	1	'9Eh'	Tag for digital signature
#29-#30	2	'8180h'	Length of digital signature (128 bytes,

**Changes to legislation:** There are currently no known outstanding effects for the Council Regulation (EEC) No 3821/85. (See end of Document for details)

			coded in accordance with ISO/IEC 7816-6)
#31-#158	128	'XX..XXh'	Digital signature content

#### RESPONSE MESSAGE

Byte	Length	Value	Description
SW	2	'XXXXh'	Status words (SW1, SW2)

- If the command is successful, the card returns '9000',
- if the verification of the signature fails, the processing state returned is '6688'. The verification process is described in Appendix 11,
- if no public key is selected, the processing state returned is '6A88',
- if some expected data objects (as specified above) are missing, the processing state '6987' is returned. This can happen if one of the required tag is missing,
- if no hash code is available to process the command (as a result of a previous PSO: hash command), the processing state returned is '6985',
- if some data objects are incorrect, the processing state returned is '6988'. This can happen if one of the required data objects length is incorrect,
- if the selected public key is considered corrupted, the processing state returned is '6400' or '6581'.

#### 4. TACHOGRAPH CARDS STRUCTURE

This paragraph specifies the file structures of the Tachograph cards for storage of accessible data,

It does not specify card manufacturer dependant internal structures, such as e.g. file headers, nor storage and handling of data elements needed for internal use only such as *EuropeanPublicKey*, *CardPrivateKey*, *TDesSessionKey* or *WorkshopCardPin*.

The useful storage capacity of Tachograph cards shall be of 11 Kbytes minimum. Greater capacities may be used. In such case, the structure of the card remains the same, but the number of records of some elements of the structure is increased. This paragraph specifies minimum and maximum values of these record numbers.

##### 4.1. Driver card structure

After its personalisation, the driver card shall have the following permanent file structure and file access conditions:

**Changes to legislation:** There are currently no known outstanding effects for the Council Regulation (EEC) No 3821/85. (See end of Document for details)

File	File ID	Access conditions		
		Read	Update	Encrypted
MF	3F00			
EF ICC	0002	ALW	NEV	No
EF IC	0005	ALW	NEV	No
DF Tachograph	0500			
EF Application_Identification	0501	ALW	NEV	No
EF Card_Certificate	C100	ALW	NEV	No
EF CA_Certificate	C108	ALW	NEV	No
EF Identification	0520	ALW	NEV	No
EF Card_Download	050E	ALW	ALW	No
EF Driving_Licence_Info	0521	ALW	NEV	No
EF Events_Data	0502	ALW	PRO SM / AUT	No
EF Faults_Data	0503	ALW	PRO SM / AUT	No
EF Driver_Activity_Data	0504	ALW	PRO SM / AUT	No
EF Vehicles_Used	0505	ALW	PRO SM / AUT	No
EF Places	0506	ALW	PRO SM / AUT	No
EF Current_Usage	0507	ALW	PRO SM / AUT	No
EF Control_Activity_Data	0508	ALW	PRO SM / AUT	No
EF Specific_Conditions	0522	ALW	PRO SM / AUT	No

All EFs structures shall be transparent.

Read with secure messaging shall be possible for all files under the DF Tachograph.

The driver card shall have the following data structure:



**Changes to legislation:** There are currently no known outstanding effects for the Council Regulation (EEC) No 3821/85. (See end of Document for details)

File/Data element	No of Records	Size (bytes)		Default Values
		Min	Max	
MF		11411	24959	
EF ICC		25	25	
CardIccIdentification		25	25	
clockStop		1	1	{00}
cardExtendedSerialNumber		8	8	{00..00}
cardApprovalNumber		8	8	{20..20}
cardPersonaliserID		1	1	{00}
embedderICAssemblerId		5	5	{00..00}
icIdentifier		2	2	{00 00}
EF IC		8	8	
CardChipIdentification		8	8	
icSerialNumber		4	4	{00..00}
icManufacturingReferences		4	4	{00..00}
DF Tachograph		11378	24926	
EF Application_Identification		10	10	
DriverCardApplicationIdentification		10	10	
typeOfTachographCardId		1	1	{00}
cardStructureVersion		2	2	{00 00}
noOfEventsPerType		1	1	{00}
noOfFaultsPerType		1	1	{00}
activityStructureLength		2	2	{00 00}
noOfCardVehicleRecords		2	2	{00 00}
noOfCardPlaceRecords		1	1	{00}
EF Card_Certificate		194	194	
CardCertificate		194	194	{00..00}
EF CA_Certificate		194	194	
MemberStateCertificate		194	194	{00..00}
EF Identification		143	143	
CardIdentification		65	65	
cardIssuingMemberState		1	1	{00}
cardNumber		16	16	{20..20}
cardIssuingAuthorityName		36	36	{20..20}
cardIssueDate		4	4	{00..00}
cardValidityBegin		4	4	{00..00}
cardExpiryDate		4	4	{00..00}
DriverCardHolderIdentification		78	78	
cardHolderName		72	72	
holderSurname		36	36	{00, 20..20}
holderFirstNames		36	36	{00, 20..20}
cardHolderBirthDate		4	4	{00..00}
cardHolderPreferredLanguage		2	2	{20 20}

*Changes to legislation: There are currently no known outstanding effects for the Council Regulation (EEC) No 3821/85. (See end of Document for details)*

EF Card_Download		4	4	
LastCardDownload		4	4	
EF Driving_Licence_Info		53	53	
CardDrivingLicenceInformation		53	53	
drivingLicenceIssuingAuthority		36	36	{00, 20..20}
drivingLicenceIssuingNation		1	1	{00}
drivingLicenceNumber		16	16	{20..20}
EF Events_Data		864	1728	
CardEventData		864	1728	
cardEventRecords	6	144	288	
CardEventRecord	n <sub>1</sub>	24	24	
eventType		1	1	{00}
eventBeginTime		4	4	{00..00}
eventEndTime		4	4	{00..00}
eventVehicleRegistration				
vehicleRegistrationNation		1	1	{00}
vehicleRegistrationNumber		14	14	{00, 20..20}
EF Faults_Data		576	1152	
CardFaultData		576	1152	
cardFaultRecords	2	288	576	
CardFaultRecord	n <sub>2</sub>	24	24	
faultType		1	1	{00}
faultBeginTime		4	4	{00..00}
faultEndTime		4	4	{00..00}
faultVehicleRegistration				
vehicleRegistrationNation		1	1	{00}
vehicleRegistrationNumber		14	14	{00, 20..20}
EF Driver_Activity_Data		5548	13780	
CardDriverActivity		5548	13780	
activityPointerOldestDayRecord		2	2	{00 00}
activityPointerNewestRecord		2	2	{00 00}
activityDailyRecords	n <sub>6</sub>	5544	13776	{00..00}
EF Vehicles_Used		2606	6202	
CardVehiclesUsed		2606	6202	
vehiclePointerNewestRecord		2	2	{00 00}
cardVehicleRecords		2604	6200	
CardVehicleRecord	n <sub>3</sub>	31	31	
vehicleOdometerBegin		3	3	{00..00}
vehicleOdometerEnd		3	3	{00..00}
vehicleFirstUse		4	4	{00..00}
vehicleLastUse		4	4	{00..00}
vehicleRegistration				
vehicleRegistrationNation		1	1	{00}
vehicleRegistrationNumber		14	14	{00, 20..20}
vuDataBlockCounter		2	2	{00 00}
EF Places		841	1121	
CardPlaceDailyWorkPeriod		841	1121	
placePointerNewestRecord		1	1	{00}
placeRecords		840	1120	
PlaceRecord	n <sub>4</sub>	10	10	
entryTime		4	4	{00..00}
entryTypeDailyWorkPeriod		1	1	{00}
dailyWorkPeriodCountry		1	1	{00}
dailyWorkPeriodRegion		1	1	{00}
vehicleOdometerValue		3	3	{00..00}
EF Current_Usage		19	19	
CardCurrentUse		19	19	
sessionOpenTime		4	4	{00..00}
sessionOpenVehicle				
vehicleRegistrationNation		1	1	{00}
vehicleRegistrationNumber		14	14	{00, 20..20}
EF Control_Activity_Data		46	46	
CardControlActivityDataRecord		46	46	
controlType		1	1	{00}
controlTime		4	4	{00..00}
controlCardNumber				
cardType		1	1	{00}
cardIssuingMemberState		1	1	{00}
cardNumber		16	16	{20..20}
controlVehicleRegistration				
vehicleRegistrationNation		1	1	{00}
vehicleRegistrationNumber		14	14	{00, 20..20}
controlDownloadPeriodBegin		4	4	{00..00}
controlDownloadPeriodEnd		4	4	{00..00}
EF Specific_Conditions		280	280	
SpecificConditionRecord	56	5	5	
entryTime		4	4	{00..00}
SpecificConditionType		1	1	{00}

**Changes to legislation:** There are currently no known outstanding effects for the Council Regulation (EEC) No 3821/85. (See end of Document for details)

The following values, used to provide sizes in the table above, are the minimum and maximum record number values the driver card data structure must use:

		Min	Max
n <sub>1</sub>	NoOfEventsPerType	6	12
n <sub>2</sub>	NoOfFaultsPerType	12	24
n <sub>3</sub>	NoOfCardVehicleRecords	84	200
n <sub>4</sub>	NoOfCardPlaceRecords	84	112
n <sub>6</sub>	CardActivityLengthRange	5 544 bytes (28 days * 93 activity changes)	13 776 bytes (28 days * 240 activity changes)

#### 4.2. Workshop card structure

After its personalisation, the workshop card shall have the following permanent file structure and file access conditions:

File	File ID	Access conditions		
		Read	Update	Encrypted
MF	3F00			
EF ICC	0002	ALW	NEV	No
EF IC	0005	ALW	NEV	No
DF Tachograph	0500			
EF Application_Identification	0501	ALW	NEV	No
EF Card_Certificate	C100	ALW	NEV	No
EF CA_Certificate	C108	ALW	NEV	No
EF Identification	0520	ALW	NEV	No
EF Card_Download	0509	ALW	ALW	No
EF Calibration	050A	ALW	PRO SM / AUT	No
EF Sensor_Installation_Data	050B	ALW	NEV	Yes
EF Events_Data	0502	ALW	PRO SM / AUT	No
EF Faults_Data	0503	ALW	PRO SM / AUT	No
EF Driver_Activity_Data	0504	ALW	PRO SM / AUT	No
EF Vehicles_Used	0505	ALW	PRO SM / AUT	No
EF Places	0506	ALW	PRO SM / AUT	No
EF Current_Usage	0507	ALW	PRO SM / AUT	No
EF Control_Activity_Data	0508	ALW	PRO SM / AUT	No
EF Specific_Conditions	0522	ALW	PRO SM / AUT	No

All EFs structures shall be transparent.

Read with secure messaging shall be possible for all files under the DF Tachograph.

The workshop card shall have the following data structure:

**Changes to legislation:** There are currently no known outstanding effects for the Council Regulation (EEC) No 3821/85. (See end of Document for details)

File/Data element	No of Records	Size (Bytes)		Default Values
		Min	Max	
<b>MF</b>		<b>11088</b>	<b>29061</b>	
<b>EF</b> ICC	25	25		
CardIccIdentification	25	25		
clockStop	1	1		{00}
cardExtendedSerialNumber	8	8		{00..00}
cardApprovalNumber	8	8		{20..20}
cardPersonaliserID	1	1		{00}
embedderIcAssemblerId	5	5		{00..00}
icIdentifier	2	2		{00 00}
<b>EF</b> IC	8	8		
CardChipIdentification	8	8		
icSerialNumber	4	4		{00..00}
icManufacturingReferences	4	4		{00..00}
<b>DF</b> Tachograph	11055	29028		
<b>EF</b> Application_Identification	11	11		
WorkshopCardApplicationIdentification	11	11		
typeOfTachographCardId	1	1		{00}
cardStructureVersion	2	2		{00 00}
noOfEventsPerType	1	1		{00}
noOfFaultsPerType	1	1		{00}
activityStructureLength	2	2		{00 00}
noOfCardVehicleRecords	2	2		{00 00}
noOfCardPlaceRecords	1	1		{00}
noOfCalibrationRecords	1	1		{00}

**Changes to legislation:** There are currently no known outstanding effects for the Council Regulation (EEC) No 3821/85. (See end of Document for details)

EF Card_Certificate		194	194	
CardCertificate		194	194	{00..00}
EF CA_Certificate		194	194	
MemberStateCertificate		194	194	{00..00}
EF Identification		211	211	
CardIdentification		65	65	
cardIssuingMemberState		1	1	{00}
cardNumber		16	16	{20..20}
cardIssuingAuthorityName		36	36	{00, 20..20}
cardIssueDate		4	4	{00..00}
cardValidityBegin		4	4	{00..00}
cardExpiryDate		4	4	{00..00}
WorkshopCardHolderIdentification		146	146	
workshopName		36	36	{00, 20..20}
workshopAddress		36	36	{00, 20..20}
cardHolderName				
holderSurname		36	36	{00, 20..20}
holderFirstNames		36	36	{00, 20..20}
cardHolderPreferredLanguage		2	2	{20 20}
EF Card_Download		2	2	
NoOfCalibrationsSinceDownload		2	2	{00 00}
EF Calibration		9243	26778	
WorkshopCardCalibrationData		9243	26778	
calibrationTotalNumber		2	2	{00 00}
calibrationPointerNewestRecord		1	1	{00}
calibrationRecords		9240	26775	
WorkshopCardCalibrationRecord	n <sub>5</sub>	105	105	
calibrationPurpose		1	1	{00}
vehicleIdentificationNumber		17	17	{20..20}
vehicleRegistration				
vehicleRegistrationNation		1	1	{00}
vehicleRegistrationNumber		14	14	{00, 20..20}
wVehicleCharacteristicConstant		2	2	{00 00}
kConstantOfRecordingEquipment		2	2	{00 00}
lTyreCircumference		2	2	{00 00}
tyreSize		15	15	{20..20}
authorisedSpeed		1	1	{00}
oldOdometerValue		3	3	{00..00}
newOdometerValue		3	3	{00..00}
oldTimeValue		4	4	{00..00}
newTimeValue		4	4	{00..00}
nextCalibrationDate		4	4	{00..00}
vuPartNumber		16	16	{20..20}
vuSerialNumber		8	8	{00..00}
sensorSerialNumber		8	8	{00..00}
EF Sensor_Installation_Data		16	16	
SensorInstallationSecData		16	16	{00..00}
EF Events_Data		432	432	
CardEventData		432	432	
cardEventRecords	6	72	72	
CardEventRecord	n <sub>1</sub>	24	24	
eventType		1	1	{00}
eventBeginTime		4	4	{00..00}
eventEndTime		4	4	{00..00}
eventVehicleRegistration				
vehicleRegistrationNation		1	1	{00}
vehicleRegistrationNumber		14	14	{00, 20..20}
EF Faults_Data		288	288	
CardFaultData		288	288	
cardFaultRecords	2	144	144	
CardFaultRecord	n <sub>2</sub>	24	24	
faultType		1	1	{00}
faultBeginTime		4	4	{00..00}
faultEndTime		4	4	{00..00}
faultVehicleRegistration				
vehicleRegistrationNation		1	1	{00}
vehicleRegistrationNumber		14	14	{00, 20..20}
EF Driver_Activity_Data		202	496	
CardDriverActivity		202	496	
activityPointerOldestDayRecord		2	2	{00 00}
activityPointerNewestRecord		2	2	{00 00}
activityDailyRecords	n <sub>6</sub>	198	492	{00..00}
EF Vehicles_Used		126	250	
CardVehiclesUsed		126	250	
vehiclePointerNewestRecord		2	2	{00 00}
cardVehicleRecords		124	248	
CardVehicleRecord	n <sub>3</sub>	31	31	
vehicleOdometerBegin		3	3	{00..00}

*Changes to legislation: There are currently no known outstanding effects for the Council Regulation (EEC) No 3821/85. (See end of Document for details)*

vehicleOdometerEnd		3	3	{00..00}
vehicleFirstUse		4	4	{00..00}
vehicleLastUse		4	4	{00..00}
vehicleRegistration				
vehicleRegistrationNation		1	1	{00}
vehicleRegistrationNumber		14	14	{00, 20..20}
vuDataBlockCounter		2	2	{00 00}
<b>EF Places</b>		<b>61</b>	<b>81</b>	
CardPlaceDailyWorkPeriod		61	81	
placePointerNewestRecord		1	1	{00}
placeRecords		60	80	
PlaceRecord	n <sub>4</sub>	10	10	
entryTime		4	4	{00..00}
entryTypeDailyWorkPeriod		1	1	{00}
dailyWorkPeriodCountry		1	1	{00}
dailyWorkPeriodRegion		1	1	{00}
vehicleOdometerValue		3	3	{00..00}
<b>EF Current_Usage</b>		<b>19</b>	<b>19</b>	
CardCurrentUse		19	19	
sessionOpenTime		4	4	{00..00}
sessionOpenVehicle				
vehicleRegistrationNation		1	1	{00}
vehicleRegistrationNumber		14	14	{00, 20..20}
<b>EF Control_Activity_Data</b>		<b>46</b>	<b>46</b>	
CardControlActivityDataRecord		46	46	
controlType		1	1	{00}
controlTime		4	4	{00..00}
controlCardNumber				
cardType		1	1	{00}
cardIssuingMemberState		1	1	{00}
cardNumber		16	16	{20..20}
controlVehicleRegistration				
vehicleRegistrationNation		1	1	{00}
vehicleRegistrationNumber		14	14	{00, 20..20}
controlDownloadPeriodBegin		4	4	{00..00}
controlDownloadPeriodEnd		4	4	{00..00}
<b>EF Specific_Conditions</b>		<b>10</b>	<b>10</b>	
SpecificConditionRecord	2	5	5	
entryTime		4	4	{00..00}
SpecificConditionType		1	1	{00}

[<sup>X1</sup>The following values, used to provide sizes in the table above, are the minimum and maximum record number values the workshop card data structure must use:

		Min	Max
n <sub>1</sub>	NoOfEventsPerType	3	3
n <sub>2</sub>	NoOfFaultsPerType	6	6
n <sub>3</sub>	NoOfCardVehicleRecords	4	8
n <sub>4</sub>	NoOfCardPlaceRecords	6	8
n <sub>5</sub>	NoOfCalibrationRecords	88	255
n <sub>6</sub>	CardActivityLengthRange	198 bytes (1 day * 93 activity changes)	492 bytes (1 day * 240 activity changes)

#### 4.3. Control card structure

After its personalisation, the control card shall have the following permanent file structure and file access conditions:

**Changes to legislation:** There are currently no known outstanding effects for the Council Regulation (EEC) No 3821/85. (See end of Document for details)

File	File ID	Access conditions		
		Read	Update	Encrypted
MF	3F00			
EF ICC	0002	ALW	NEV	No
EF IC	0005	ALW	NEV	No
DF Tachograph	0500			
EF Application_Identification	0501	ALW	NEV	No
EF Card_Certificate	C100	ALW	NEV	No
EF CA_Certificate	C108	ALW	NEV	No
EF Identification	0520	AUT	NEV	No
EF Controller_Activity_Data	050C	ALW	PRO SM / AUT	No

All EFs structures shall be transparent.

Read with secure messaging shall be possible for files under the DF Tachograph.

The control card shall have the following data structure:

*Changes to legislation: There are currently no known outstanding effects for the Council Regulation (EEC) No 3821/85. (See end of Document for details)*

Archivo/Elemento de datos	No of Records	Size (Bytes)		Default Values
		Min	Max	
<b>MF</b>		<b>11219</b>	<b>24559</b>	
EF ICC	25	25		
CardIccIdentification	25	25		
clockStop	1	1		{00}
cardExtendedSerialNumber	8	8		{00..00}
cardApprovalNumber	8	8		{20..20}
cardPersonaliserID	1	1		{00}
embedderIcAssemblerId	5	5		{00..00}
icIdentifier	2	2		{00 00}
EF IC	8	8		
CardChipIdentification	8	8		
icSerialNumber	4	4		{00..00}
icManufacturingReferences	4	4		{00..00}
<b>DF Tachograph</b>	<b>11186</b>	<b>24526</b>		
EF Application_Identification	5	5		
ControlCardApplicationIdentification	5	5		
typeOfTachographCardId	1	1		{00}
cardStructureVersion	2	2		{00 00}
noOfControlActivityRecords	2	2		{00 00}
EF Card_Certificate	194	194		
CardCertificate	194	194		{00..00}
EF CA_Certificate	194	194		
MemberStateCertificate	194	194		{00..00}
EF Identification	211	211		
CardIdentification	65	65		
cardIssuingMemberState	1	1		{00}
cardNumber	16	16		{20..20}
cardIssuingAuthorityName	36	36		{00, 20..20}
cardIssueDate	4	4		{00..00}
cardValidityBegin	4	4		{00..00}
cardExpiryDate	4	4		{00..00}
ControlCardHolderIdentification	146	146		
controlBodyName	36	36		{00, 20..20}
controlBodyAddress	36	36		{00, 20..20}
cardHolderName				
holderSurname	36	36		{00, 20..20}
holderFirstNames	36	36		{00, 20..20}
cardHolderPreferredLanguage	2	2		{20 20}
EF Controller_Activity_Data	10582	23922		
ControlCardControlActivityData	10582	23922		
controlPointerNewestRecord	2	2		{00 00}
controlActivityRecords	10580	23920		
controlActivityRecord	n <sub>7</sub>	46	46	
controlType	1	1		{00}
controlTime	4	4		{00..00}
controlledCardNumber				
cardType	1	1		{00}
cardIssuingMemberState	1	1		{00}
cardNumber	16	16		{20..20}
controlledVehicleRegistration				
vehicleRegistrationNation	1	1		{00}
vehicleRegistrationNumber	14	14		{00, 20..20}
controlDownloadPeriodBegin	4	4		{00..00}
controlDownloadPeriodEnd	4	4		{00..00}

The following values, used to provide sizes in the table above, are the minimum and maximum record number values the control card data structure must use:

		Min	Max
n <sub>7</sub>	NoOfControlActivityRecords	200	520

#### 4.4. Company card structure



**Changes to legislation:** There are currently no known outstanding effects for the Council Regulation (EEC) No 3821/85. (See end of Document for details)

After its personalisation, the company card shall have the following permanent file structure and file access conditions:

File	File ID	Access conditions		
		Read	Update	Encrypted
MF	3F00			
EF ICC	0002	ALW	NEV	No
EF IC	0005	ALW	NEV	No
DF Tachograph	0500			
EF Application_Identification	0501	ALW	NEV	No
EF Card_Certificate	C100	ALW	NEV	No
EF CA_Certificate	C108	ALW	NEV	No
EF Identification	0520	AUT	NEV	No
EF Company_Activity_Data	050D	ALW	PRO SM / AUT	No

All EFs structures shall be transparent.

Read with secure messaging shall be possible for all files under the DF Tachograph.

The company card shall have the following data structure:

*Changes to legislation: There are currently no known outstanding effects for the Council Regulation (EEC) No 3821/85. (See end of Document for details)*

File/Data element	No of Records	Size (bytes)		Default Values
		Min	Max	
<b>MF</b>		<b>11147</b>	<b>24487</b>	
EF ICC	25	25		
CardIccIdentification	25	25		
clockStop	1	1		{00}
cardExtendedSerialNumber	8	8		{00..00}
cardApprovalNumber	8	8		{20..20}
cardPersonaliserID	1	1		{00}
embedderIcAssemblerId	5	5		{00..00}
icIdentifier	2	2		{00 00}
EF IC	8	8		
CardChipIdentification	8	8		
icSerialNumber	4	4		{00..00}
icManufacturingReferences	4	4		{00..00}
<b>DF Tachograph</b>	<b>11114</b>	<b>24454</b>		
EF Application_Identification	5	5		
CompanyCardApplicationIdentification	5	5		
typeOfTachographCardId	1	1		{00}
cardStructureVersion	2	2		{00 00}
noOfCompanyActivityRecords	2	2		{00 00}
EF Card_Certificate	194	194		
CardCertificate	194	194		{00..00}
EF CA_Certificate	194	194		
MemberStateCertificate	194	194		{00..00}
EF Identification	139	139		
CardIdentification	65	65		
cardIssuingMemberState	1	1		{00}
cardNumber	16	16		{20..20}
cardIssuingAuthorityName	36	36		{00, 20..20}
cardIssueDate	4	4		{00..00}
cardValidityBegin	4	4		{00..00}
cardExpiryDate	4	4		{00..00}
CompanyCardHolderIdentification	74	74		
companyName	36	36		{00, 20..20}
companyAddress	36	36		{00, 20..20}
cardHolderPreferredLanguage	2	2		{20 20}
EF Company_Activity_Data	10582	23922		
CompanyActivityData	10582	23922		
companyPointerNewestRecord	2	2		{00 00}
companyActivityRecords	10580	23920		
companyActivityRecord	n <sub>8</sub>	46	46	
companyActivityType	1	1		{00}
companyActivityTime	4	4		{00..00}
cardNumberInformation				
cardType	1	1		{00}
cardIssuingMemberState	1	1		{00}
cardNumber	16	16		{20..20}
vehicleRegistrationInformation				
vehicleRegistrationNation	1	1		{00}
vehicleRegistrationNumber	14	14		{00, 20..20}
downloadPeriodBegin	4	4		{00..00}
downloadPeriodEnd	4	4		{00..00}

The following values, used to provide sizes in the table above, are the minimum and maximum record number values the company card data structure must use:

	Min	Max
n <sub>8</sub>	NoOfCompanyActivityRecords	520





*Changes to legislation: There are currently no known outstanding effects for the Council Regulation (EEC) No 3821/85. (See end of Document for details)*







### Appendix 3









#### PICTOGRAMS

[<sup>F15</sup>The recording equipment may optionally use the following pictograms and pictogram combinations (or pictograms and combination similar enough to be unambiguously identifiable with these):]

##### 1. BASIC PICTOGRAMS

	People	Actions	Modes of operation
	Company		Company mode
	Controller	Control	Control mode
	Driver	Driver	Operational mode
	Workshop/test station	Inspection/calibration	Calibration mode
	Manufacturer		

	Activities	Duration
	Available	Current availability period
	Driving	Continuous driving time
	Rest	Current rest period
	Work	Current work period
	Break	Cumulative break time
	Unknown	

	Equipment	Functions
<b>1</b>	Driver slot	
<b>2</b>	Co-driver slot	
	Card	
	Clock	
	Display	Displaying
	External storage	Downloading
	Power supply	
	Printer/printout	Printing
	Sensor	
	Tyre size	

*Changes to legislation: There are currently no known outstanding effects for the Council Regulation (EEC) No 3821/85. (See end of Document for details)*

<b>A</b>	Vehicle/vehicle unit		
			Specific conditions
<b>OUT</b>			Out of scope
<b>A</b>			Ferry/train crossing
	Miscellaneous		
<b>!</b>	Events	<b>x</b>	Faults
<b>▶</b>	Start of daily work period	<b>▶</b>	End of daily work period
<b>*</b>	Location	<b>M</b>	Manual entry of driver activities
<b>Ⓜ</b>	Security	<b>&gt;</b>	Speed
<b>Ⓢ</b>	Time	<b>Σ</b>	Total/summary
			Qualifiers
<b>24h</b>			Daily
<b>I</b>			Weekly
<b>II</b>			Two weeks
<b>+</b>			From or to

## 2. PICTOGRAM COMBINATIONS

	Miscellaneous		
<b>Ⓜ*</b>	Control place		
<b>*▶</b>	Location start of daily work period	<b>▶*</b>	Location end of daily work period
<b>Ⓢ+</b>	From time	<b>+Ⓢ</b>	To time
<b>A+</b>	From vehicle		
<b>OUT+</b>	Out of scope begin	<b>+OUT</b>	Out of scope end
			Cards
<b>ⓈⓂ</b>			Driver card
<b>ⓂⓂ</b>			Company card
<b>ⓂⓂ</b>			Control card
<b>TⓂ</b>			Workshop card
<b>Ⓜ - - -</b>			No card

**Changes to legislation:** There are currently no known outstanding effects for the Council Regulation (EEC) No 3821/85. (See end of Document for details)

	Driving
00	Crew driving
0	Driving time for one week
0	Driving time for two weeks
	Printouts
24h □ ▽	Driver activities from card daily printout
24h ▴ ▽	Driver activities from VU daily printout
! × □ ▽	Events and faults from card printout
! × ▴ ▽	Events and faults from VU printout
T □ ▽	Technical data printout
>> ▽	Over speeding printout
	Events
! □	Insertion of a non valid card
! □ □	Card conflict
! 00	Time overlap
! 0 □	Driving without an appropriate card
! □ 0	Card insertion while driving
! □ ▴	Last card session not correctly closed
>>	Over speeding
! †	Power supply interruption
! ∟	Motion data error
! □	Security breach
! 0	Time adjustment (by workshop)
> □	Over speeding control
[ <sup>F18</sup> ! ▴ ∟	Vehicle Motion Conflict]
	Faults
× □ 1	Card fault (driver slot)
× □ 2	Card fault (co-driver slot)

---

**Changes to legislation:** There are currently no known outstanding effects for the Council Regulation (EEC) No 3821/85. (See end of Document for details)

---

×□	Display fault
×⇩	Downloading fault
×▼	Printer fault
×∩	Sensor fault
×Ⓐ	VU internal fault
	Manual entries procedure
▷?∩	Still same daily work period?
∩?	End of previous work period?
∩●?	Confirm or enter location of end of work period
⊙▷?	Enter start time
●▷?	Enter location of start of work period.

Note: Additional pictogram combinations to form printout block or record identifiers are defined in Appendix 4.

---

**Changes to legislation:** There are currently no known outstanding effects for the Council Regulation (EEC) No 3821/85. (See end of Document for details)

---

## Appendix 4

### PRINTOUTS

#### 1. GENERALITIES

Each printout is built up by chaining various data blocks, possibly identified with a block identifier.

A data block contains one or more records, possibly identified with a record identifier.

When a block identifier immediately precedes a record identifier, the record identifier is not printed.

In the case where a data item is unknown, or must not be printed for data access rights reasons, spaces are printed instead.

If the content of a complete line is unknown, or need not to be printed, then the complete line is omitted.

Numerical data fields are printed right aligned, with a space separator for thousands and millions, and without leading zeros.

String data fields are printed left aligned and filled up with spaces to data item length, or truncated to data item length when needed (names and addresses).

#### 2. DATA BLOCKS SPECIFICATION

In this chapter the following format notation conventions have been used:

- characters printed in *bold* denote plain text to be printed (printing remains in normal characters),
- normal characters denote variables (pictograms or data) to be replaced by their values for printing,
- variable names have been padded with underscores to show the data item length available for the variable,
- dates are specified with a 'dd/mm/yyyy' (day, month, year) format. A 'dd.mm.yyyy' format may also be used,
- the term 'card identification' denotes the composition of: the type of card through a card pictograms combination, the card issuing Member State code, a forward slash character and the card number with the replacement index and the renewal index separated with a space:

[<sup>F15</sup>Printouts shall use the following data blocks and/or data records, in accordance with the following meanings and formats:

Block or record number Meaning	Data Format
1 <b><i>Date and time at which the document is printed.</i></b>	▼ dd/mm/yyyy hh:mm (UTC)
<b>2 Type of printout</b>	
Block identifier	-----▼-----

*Changes to legislation: There are currently no known outstanding effects for the Council Regulation (EEC) No 3821/85. (See end of Document for details)*

## 2 Type of printout

Printout pictogram combination (see App. 3), Speed limiting device setting (Over speeding printout only)	Picto xxx <b>km/h</b>
--	-----------------------

## 3 Card holder identification

Block identifier. P= people pictogram	-----P-----
Card holder surname	P Last_Name
Card holder first name(s) (if any)	First_Name
Card identification	Card_Identification
Card expiry date (if any)	dd/mm/yyyy

In the case where the card is a non-personal card, and holds no card holder surname, the company or workshop or control body name shall be printed instead.

## 4 Vehicle identification

Block identifier	-----A-----
VIN	A VIN
Registering Member State and VRN	Nat/VRN

## 5 VU identification

Block identifier	-----B-----
VU manufacturer's name	B VU_Manufacturer
VU part number	VU_Part_Number

## 6 Last calibration of the recording equipment

Block identifier	-----T-----
Workshop name	T Last_Name
Workshop card identification	Card_Identification
Date of the calibration	T dd/mm/yyyy

## 7 Last control (by a control officer)

Block identifier	-----C-----
Controller's card identification	Card_Identification
Control date, time and type	C dd/mm/yyyy hh:mm pppp

Type of the control: Up to four pictograms. The type of control can be (a combination) of:

■: Card downloading, ▼: VU downloading, ▽: printing, □: Displaying

## 8 Driver activities stored on a card in order of occurrence

Block identifier	-----D-----
Enquiry date (calendar day subject of the printout) + Daily card presence counter	dd/mm/yyyy xxx



















**Changes to legislation:** There are currently no known outstanding effects for the Council Regulation (EEC) No 3821/85. (See end of Document for details)

8a	<i>Out of scope condition in the beginning of this day</i> (leave blank if no out of scope condition open)	-----OUT-----
<b>8.1 Period during which the card was not inserted</b>		
8.1a	Record identifier (start of period)	-----
8.1b	<i>Unknown period.</i> Start time, duration	?: hh:mm hhhmm
8.1c	<i>Activity manually entered</i>	A: hh:mm hhhmm
Activity pictogram, start time, duration.		
<b>8.2 Card insertion in slot S</b>		
Record identifier; S = Slot pictogram		-----S-----
Vehicle registering Member State and VRN		■ Nat/VRN
Vehicle odometer at card insertion		x xxx xxx <b>km</b>
<b>8.3 Activity (while card was inserted)</b>		
Activity pictogram, start time, duration, crew status (crew pictogram if CREW, blanks if SINGLE)		A: hh:mm hhhmm
8.3a	<i>Specific condition.</i> Time of entry, specific condition pictogram (or pictogram combination).	hh:mm - - - pppp - - -
<b>8.4 Card withdrawal</b>		
Vehicle odometer and distance travelled since last insertion for which odometer is known		x xxx xxx <b>km</b> ; x xxx <b>km</b>
<b>9 Driver activities stored in a VU per slot in chronological order</b>		
Block identifier		-----■-----
Enquiry date (calendar day subject of the printout)		dd/mm/yyyy
Vehicle odometer at 00:00 and 24:00		x xxx xxx - x xxx xxx <b>km</b>
<b>10 Activities carried in slot S</b>		
Block identifier		-----S-----
10a	<i>Out of scope condition in the beginning of this day</i> (leave blank if no out of scope condition open)	-----OUT-----
<b>10.1 Period where no card is inserted in slot S</b>		
Record identifier.		-----

*Changes to legislation: There are currently no known outstanding effects for the Council Regulation (EEC) No 3821/85. (See end of Document for details)*

<b>10.1 Period where no card is inserted in slot S</b>	
No Card inserted	☐ - - -
Vehicle odometer at beginning of period	x xxx xxx <b>km</b>
<b>10.2 Card insertion</b>	
Card insertion Record identifier	- - - - -
Driver's name	☐ Last_Name
Driver's first name	First_Name
Driver's Card identification	Card_Identification
Driver's card expiry date	dd/mm/yyyy
Registering MS and VRN of previous vehicle used	##Nat/VRN
Date and time of card withdrawal from previous vehicle	dd/mm/yyyy hh:mm
Blank line	
Vehicle odometer at card insertion, Manual entry of driver activities flag (M if yes, Blank if No).	x xxx xxx <b>km M</b>
If no card insertion of a driver card happened on the day for which the printout is done then for block 10.2 the odometer data reading from the last available card insertion before that day shall be used.	
<b>10.3 Activity</b>	
Activity pictogram, start time, duration, crew Status (crew pictogram if CREW, blanks if SINGLE)	A ÷ hh:mm hhhmm☐☐
10.3a <i>Specific condition.</i> Time of entry, specific condition pictogram (or pictogram combination).	hh:mm - - - pppp - - -
<b>10.4 Card withdrawal or End of 'No Card' period</b>	
Vehicle odometer at card withdrawal or at end of 'no card' period and distance travelled since insertion, or since beginning of the 'No Card' period.	x xxx xxx <b>km</b> ; x xxx <b>km</b>
<b>11 Daily summary</b>	
Block identifier	- - - - -Σ- - - - -
<b>11.1 VU summary of periods without card in driver slot</b>	
Block identifier	1☐ - - -

**Changes to legislation:** There are currently no known outstanding effects for the Council Regulation (EEC) No 3821/85. (See end of Document for details)

<b>11.2 VU summary of periods without card in co-driver slot</b>	
Block identifier	2  - - -
<b>11.3 VU daily summary per driver</b>	
Record identifier	- - - - -
Driver's surname	 Last_Name
Driver's first name(s)	First_Name
Driver's card identification	Card_Identification
<b>11.4 Entry of place where a daily work period begins and/or ends</b>	
pi=location begin / end pictogram, time, country, region,	pihh:mm Cou Reg
Odometer	x xxx xxx <b>km</b>
<b>11.5 Activity totals (from a card)</b>	
Total driving duration, distance travelled	 hh:mm x xxx <b>km</b>
Total working and availability duration	 hh:mm  hh:mm
Total resting and unknown duration	 hh:mm ? hh:mm
Total duration of crew activities	 hh:mm
<b>11.6 Activity totals (periods without card driver slot)</b>	
Total driving duration, distance travelled	 hh:mm x xxx <b>km</b>
Total working and availability duration	 hh:mm  hh:mm
Total resting duration	 hh:mm
<b>11.7 Activity totals (periods without card co-driver slot)</b>	
Total working and availability duration	 hh:mm  hh:mm
Total resting duration	 hh:mm
<b>11.8 Activity totals (per driver both slots included)</b>	
Total driving duration, distance travelled	 hh:mm x xxx <b>km</b>
Total working and availability duration	 hh:mm  hh:mm
Total resting duration	 hh:mm
Total duration of crew activities	 hh:mm
When a daily printout is required for the current day, daily summary information is computed with available data at the time of the printout.	
<b>12 Events and/or faults stored on a card</b>	
12.1 Block identifier last 5 'Events and Faults' from a card	- - - - -  - - - - -
12.2 Block identifier all recorded 'Events' on a card	- - - - -  - - - - -

*Changes to legislation: There are currently no known outstanding effects for the Council Regulation (EEC) No 3821/85. (See end of Document for details)*

12.3	Block identifier all recorded 'Faults' on a card	-----x#-----
<b>12.4 Event and/or Fault record</b>		
	Record identifier	-----
	Event/fault pictogram, record purpose, date time of start,	Pic (p) dd/mm/yyyy hh:mm
	Additional event/fault code (if any), duration	! xx hhmm
	Registering Member State & VRN of vehicle in which the event or fault occurred	# Nat/VRN
<b>13 Events and/or faults stored or on-going in a VU</b>		
13.1	Block identifier last 5 'Events and Faults' from VU	-----!xA-----
13.2	Block identifier all recorded or on-going 'Events' in a VU	-----!A-----
13.3	Block identifier all recorded or on-going 'Faults' in a VU	-----xA-----
<b>13.4 Event and/or fault record</b>		
	Record identifier	-----
	Event/fault pictogram, record purpose, date time of start,	Pic (p) dd/mm/yyyy hh:mm
	Additional event/fault code (if any), No of similar events this day, duration	! xx (xxx) hhmm
	Identification of the cards inserted at start or end of the event or fault (up to 4 lines without repeating twice the same card numbers)	Card_Identification Card_Identification Card_Identification Card_Identification
	Case where no card was inserted	# ---
The record purpose (p) is a numerical code explaining why the event or fault was recorded, coded in accordance with the data element EventFaultRecordPurpose.		
<b>14 VU Identification</b>		
	Block identifier	-----#-----
	VU manufacturer name	# Name
	VU manufacturer address	Address
	VU part number	PartNumber
	VU approval number	Apprv
	VU serial number	S/N
	VU year of manufacture	Yyyy

**Changes to legislation:** There are currently no known outstanding effects for the Council Regulation (EEC) No 3821/85. (See end of Document for details)

<b>14 VU Identification</b>	
VU software version and installation date	V xxxx dd/mm/yyyy
<b>15 Sensor identification</b>	
Block identifier	----- <b>fl</b> -----
Sensor serial number	fl S/N
Sensor approval number	Apprv
Sensor first installation date	dd/mm/yyyy]

### 3. PRINTOUT SPECIFICATIONS

In this chapter the following notation conventions have been used:

N	Print block or record number N
N	Print block or record number N repeated as many times as necessary
X/Y	Print blocks or records X and/or Y as needed, and repeating as many times as necessary

#### [<sup>F15</sup>3.1. Driver Activities from Card Daily Printout

The driver activities from card daily printout shall be in accordance with the following format:

1	Date and time at which the document is printed
2	Type of printout
3	Controller identification (if a control card is inserted in the VU)
3	Driver identification (from card subject of the printout)
4	Vehicle identification (vehicle from which printout is taken)
5	VU identification (VU from which printout is taken)
6	Last calibration of this VU
7	Last control the inspected driver has been subject to
8	Driver activities delimiter
8a	Out of scope condition in the beginning of this day

**Changes to legislation:** There are currently no known outstanding effects for the Council Regulation (EEC) No 3821/85. (See end of Document for details)

8.1a / 8.1b / 8.1c / 8.2 / 8.3 / 8.3a / 8.4	Activities of the driver in order of occurrence
11	Daily summary delimiter
11.4	Places entered in chronological order
11.5	Activity totals
12.1	Events or faults from card delimiter
12.4	Event/Fault records (Last 5 events or faults stored in the card)
13.1	Events or faults from VU delimiter
13.4	Event/Fault records (Last 5 events or faults stored or on-going in the VU)
21.1	Control place
21.2	Controller's signature
21.5	Driver's signature]

### [<sup>F15</sup>3.2. Driver Activities from daily VU printout

The driver activities from VU daily printout shall be in accordance with the following format:

1	Date and time at which the document is printed
2	Type of printout
3	Card holder identification (for all cards inserted in VU)
4	Vehicle identification (vehicle from which printout is taken)
5	VU identification (VU from which printout is taken)
6	Last calibration of this VU
7	Last control on this recording equipment
9	Driver activities delimiter
10	Driver slot delimiter (slot 1)
10a	Out of scope condition in the beginning of this day
10.1 / 10.2 / 10.3 / 10.3a / 10.4	Activities in chronological order (driver slot)
10	Co-driver slot delimiter (slot 2)
10a	Out of scope condition in the beginning of this day
10.1 / 10.2 / 10.3 / 10.3a / 10.4	Activities in chronological order (co-driver slot)

**Changes to legislation:** There are currently no known outstanding effects for the Council Regulation (EEC) No 3821/85. (See end of Document for details)

11	Daily summary delimiter
11.1	Summary of periods without card in driver slot
11.4	Places entered in chronological order
11.6	Activity totals
11.2	Summary of periods without card in co-driver slot
11.4	Places entered in chronological order
11.8	Activity totals
11.3	Summary of activities for a driver both slots included
11.4	Places entered by this driver in chronological order
11.7	Activity totals for this driver
13.1	Events faults delimiter
13.4	Event/Fault records (Last 5 events or faults stored or on-going in the VU)
21.1	Control place
21.2	Controller's signature
21.3	From time (space available for a driver without a card to indicate
21.4	To time which periods are relevant to himself)
21.5	Driver's signature]

### 3.3. Events and faults from card printout

The events and faults from card printout shall be in accordance with the following format:

1	Date and time at which the document is printed
2	Type of printout
3	Controller identification (if a control card is inserted in the VU)
3	Driver identification (from card subject of the printout)
4	Vehicle identification (vehicle from which printout is taken)

*Changes to legislation: There are currently no known outstanding effects for the Council Regulation (EEC) No 3821/85. (See end of Document for details)*

12.2	Events delimiter
12.4	Event records (all events stored on the card)
12.3	Faults delimiter
12.4	Fault records (all faults stored on the card)
21.1	Control place
21.2	Controller's signature
21.5	Driver's signature

#### 3.4. Events and faults from VU printout

The events and faults from VU printout shall be in accordance with the following format:

1	Date and time at which the document is printed
2	Type of printout
3	Card holder identification (for all cards inserted in VU)
4	Vehicle identification (vehicle from which printout is taken)
13.2	Events delimiter
13.4	Event records (All Events stored or on-going in the VU)
13.3	Faults delimiter
13.4	Fault records (All Faults stored or on-going in the VU)
21.1	Control place



**Changes to legislation:** There are currently no known outstanding effects for the Council Regulation (EEC) No 3821/85. (See end of Document for details)

21.2	Controller's signature
21.5	Driver's signature

### 3.5. Technical data printout

The technical data printout shall be in accordance with the following format:

1	Date and time at which the document is printed
2	Type of printout
<b>3</b>	Card holder identification (for all cards inserted in VU)
4	Vehicle identification (vehicle from which printout is taken)
14	VU identification
15	Sensor identification
16	Calibration data delimiter
<b>16.1</b>	Calibration records (all records available in chronological order)
17	Time adjustment delimiter
<b>17.1</b>	Time adjustment records (all records available from time adjustment and from calibration data records)
18	Most recent event and Fault recorded in the VU

### 3.6. Over speeding printout

The over speeding printout shall be in accordance with the following format:

1	Date and time at which the document is printed
2	Type of printout

*Changes to legislation: There are currently no known outstanding effects for the Council Regulation (EEC) No 3821/85. (See end of Document for details)*

<b>3</b>	Card holder identification (for all cards inserted in VU)
4	Vehicle identification (vehicle from which printout is taken)
19	Over speeding control information
20.1	Over speeding data identifier
20.4 / 20.5	First over speeding after the last calibration
20.2	Over speeding data identifier
<b>20.4 / 20.5</b>	The 5 most serious over speeding events over the last 365 days
20.3	Over speeding data identifier
<b>20.4 / 20.5</b>	The most serious over speeding for each of the last 10 days of occurrence
21.1	Control place
21.2	Controller's signature
21.5	Driver's signature.

**Changes to legislation:** There are currently no known outstanding effects for the Council Regulation (EEC) No 3821/85. (See end of Document for details)

## Appendix 5

### DISPLAY

In this appendix the following format notation conventions have been used:

- characters printed in *bold* denote plain text to be displayed (display remains in normal character),
- normal characters denote variables (pictograms or data) to be replaced by their values for displaying:

dd mm	:	day, month, year,
yyyy		
hh	:	hours,
mm	:	minutes,
D	:	duration pictogram,
EF	:	event or fault pictograms combination,
O	:	mode of operation pictogram.

The recording equipment shall display data using the following formats:

Data	<i>Format</i>
<b>Default display</b>	
Local time	<i>hh:mm</i>
Mode of operation	<i>O</i>
Information related to the driver	<b>1</b> <i>Dhhmm■hhmm</i>
Information related to the co-driver	<b>2</b> <i>Dhhmm</i>
Out of scope condition opened	<b>OUT</b>
<b>Warning display</b>	
Exceeding continuous driving time	<b>1</b> <i>⊙hhmm■hhmm</i>
Event or fault	<i>EF</i>
<b>Other displays</b>	
UTC date	<i>UTC</i> <b>⊙</b> <i>dd/mm/yyyy</i> or <i>UTC</i> <b>⊙</b> <i>dd.mm.yyyy</i>
time	<i>hh:mm</i>
Driver's continuous driving time and cumulative break time	<b>1</b> <i>⊙hhmm■hhmm</i>
Co-driver's continuous driving time and cumulative break time	<b>2</b> <i>⊙hhmm■hhmm</i>
Driver's cumulated driving time for the previous and the current week	<b>1</b> <i>⊙  hhhhmm</i>
Co-driver's cumulated driving time for the previous and the current week	<b>2</b> <i>⊙  hhhhmm</i>

*Changes to legislation: There are currently no known outstanding effects for the Council Regulation (EEC) No 3821/85. (See end of Document for details)*

## Appendix 6

### EXTERNAL INTERFACES

#### 1. HARDWARE

##### 1.1. Connector

The downloading/calibration connector shall be a six pin connector, accessible on the front panel without the need to disconnect any part of the recording equipment, and shall comply with the following drawing (all dimensions in millimetres):

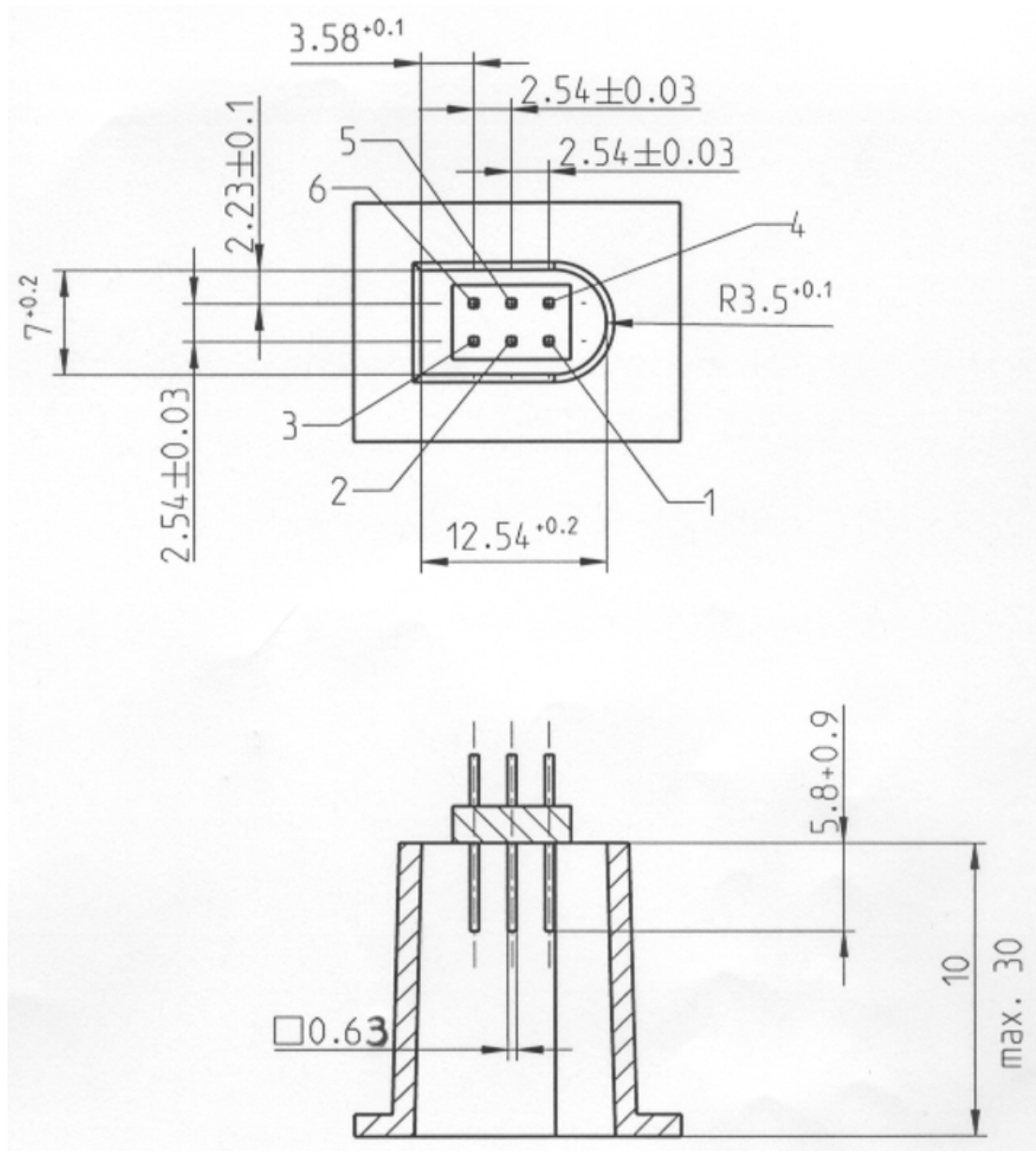

The following diagram shows a typical six pin mating plug:

**Changes to legislation:** There are currently no known outstanding effects for the Council Regulation (EEC) No 3821/85. (See end of Document for details)

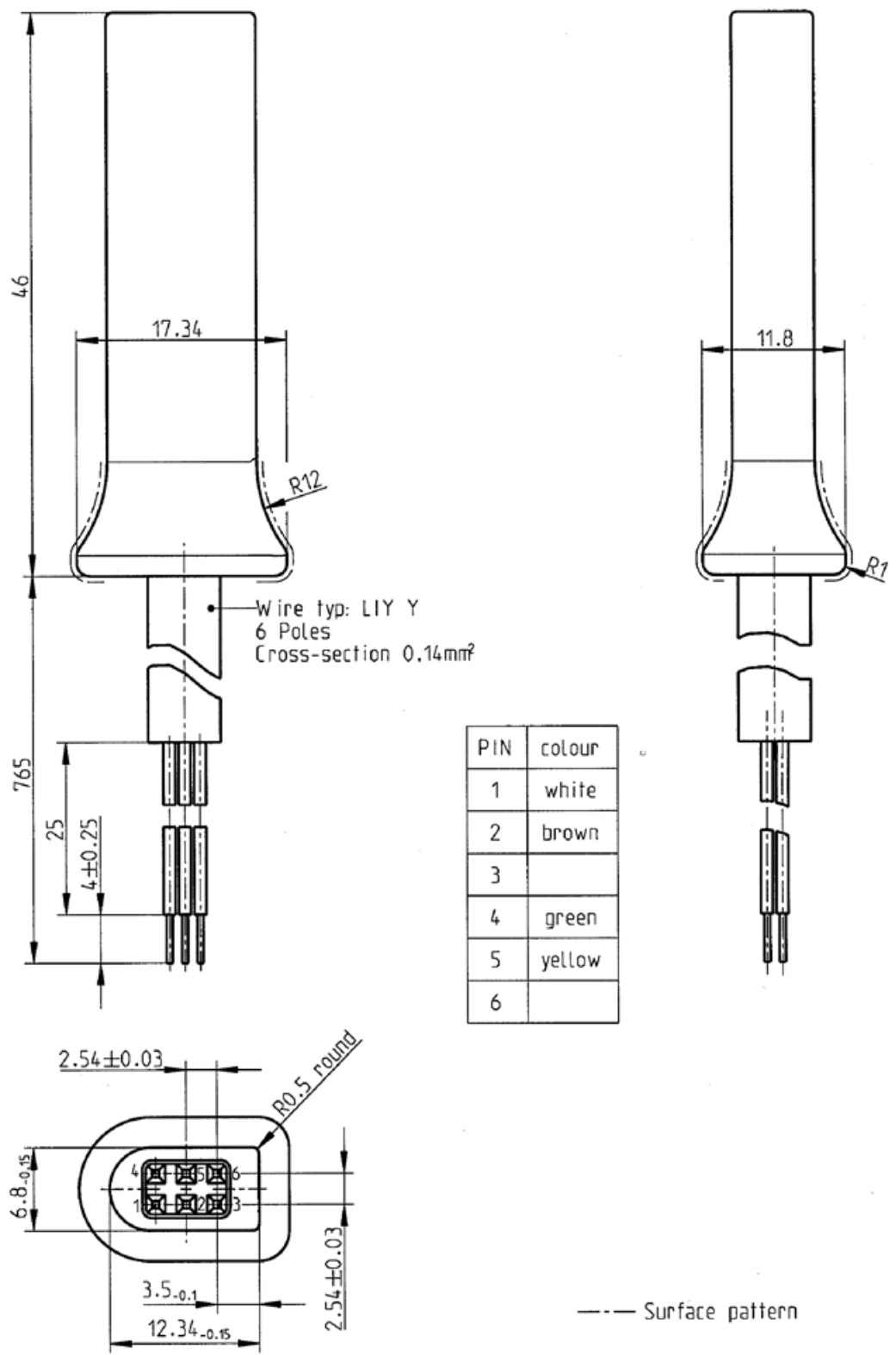

1.2. Contact allocation

*Changes to legislation: There are currently no known outstanding effects for the Council Regulation (EEC) No 3821/85. (See end of Document for details)*

Contacts shall be allocated in accordance with the following table:

Pin	Description	Remark
1	Battery minus	Connected to the battery minus of the vehicle
2	Data communication	K-line (ISO 14 230-1)
3	RxD — Downloading	Data input to recording equipment
4	Input/output signal	Calibration
5	Permanent power output	The voltage range is specified to be that of the vehicle power minus 3V to allow for the voltage drop across the protective circuitry Output 40 mA
6	TxD — Downloading	Data output from recording equipment

### 1.3. Block diagram

The block diagram shall comply with the following:

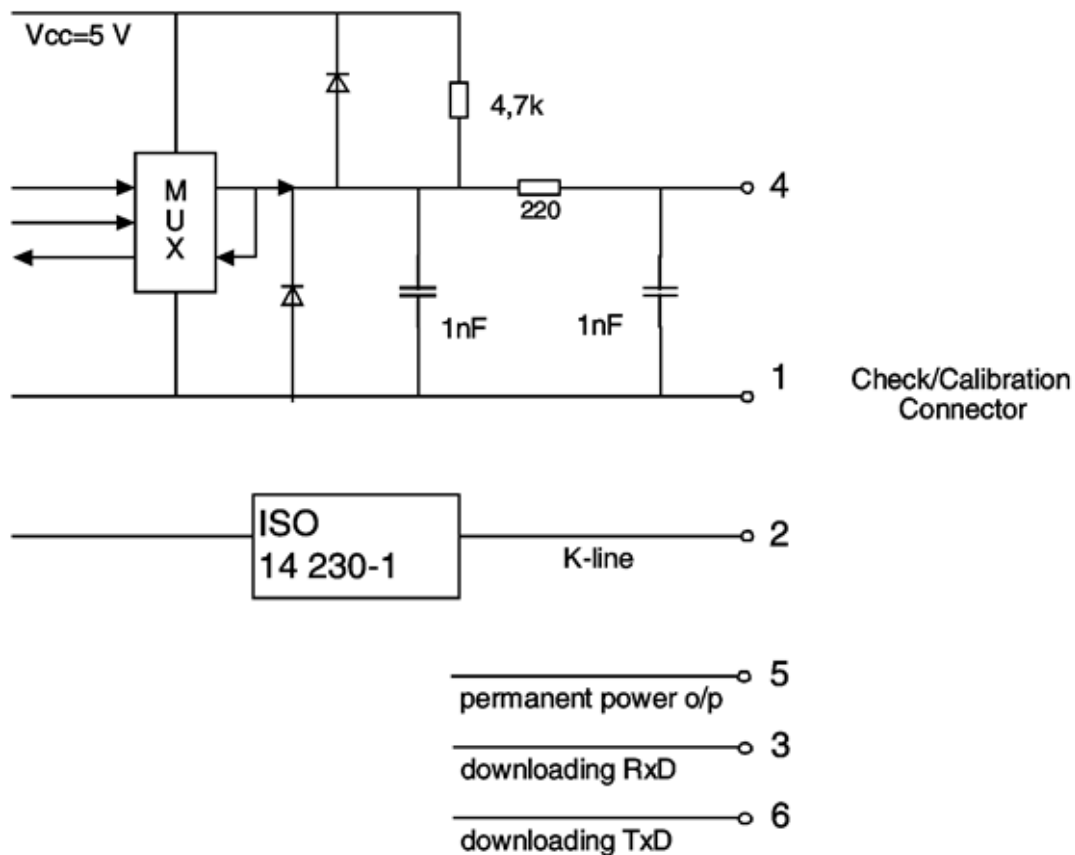

*Changes to legislation: There are currently no known outstanding effects for the Council Regulation (EEC) No 3821/85. (See end of Document for details)*

## 2. DOWNLOADING INTERFACE

The downloading interface shall comply to RS232 specifications.

The downloading interface shall use one start bit, 8 data bits LSB first, one even parity bit and 1 stop bit.

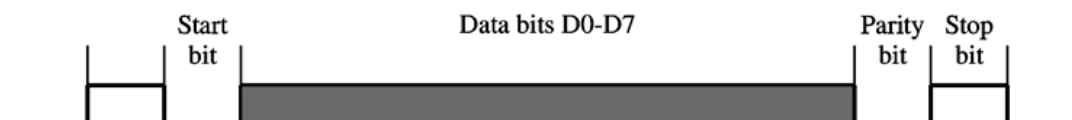

- Start bit : one bit with logic level 0
- Data bits : transmitted with LSB first
- Parity bit : even parity
- Stop bit : one bit with logic level 1

When numerical data composed by more than one byte are transmitted, the most significant byte is transmitted first and the least significant byte last.

Transmission baud rates shall be adjustable from 9 600 bps to 115 200 bps. Transmission shall be achieved at the highest possible transmission speed, the initial baud rate after a start of communication being set at 9 600 bps.

## 3. CALIBRATION INTERFACE

The data communication shall comply to ISO 14 230-1 Road vehicles — Diagnostic systems — Keyword protocol 2000 — Part 1: Physical layer, First edition: 1999.

The input/output signal shall comply with the following electrical specification:

Parameter	Minimum	Typical	Maximum	Remark
U <sub>low</sub> (in)			1,0 V	I = 750 μA
U <sub>high</sub> (in)	4 V			I = 200 μA
Frequency			4 kHz	
U <sub>low</sub> (out)			1,0 V	I = 1 mA
U <sub>high</sub> (out)	4 V			I = 1 mA

The input/output signal shall comply with the following timing diagrams:

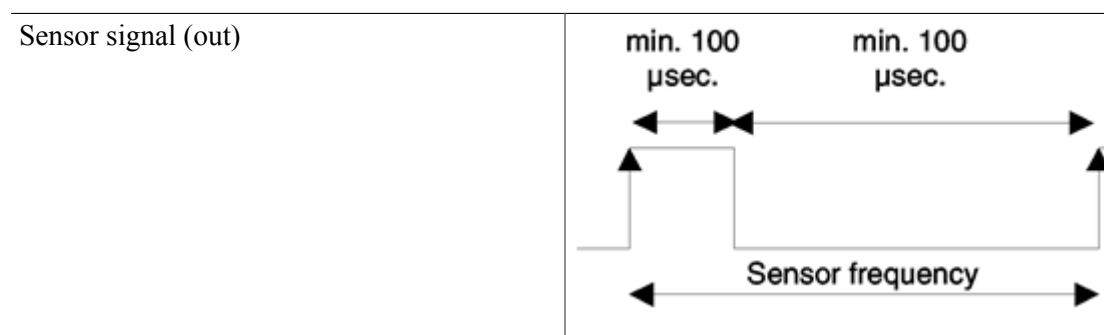

**Changes to legislation:** There are currently no known outstanding effects for the Council Regulation (EEC) No 3821/85. (See end of Document for details)

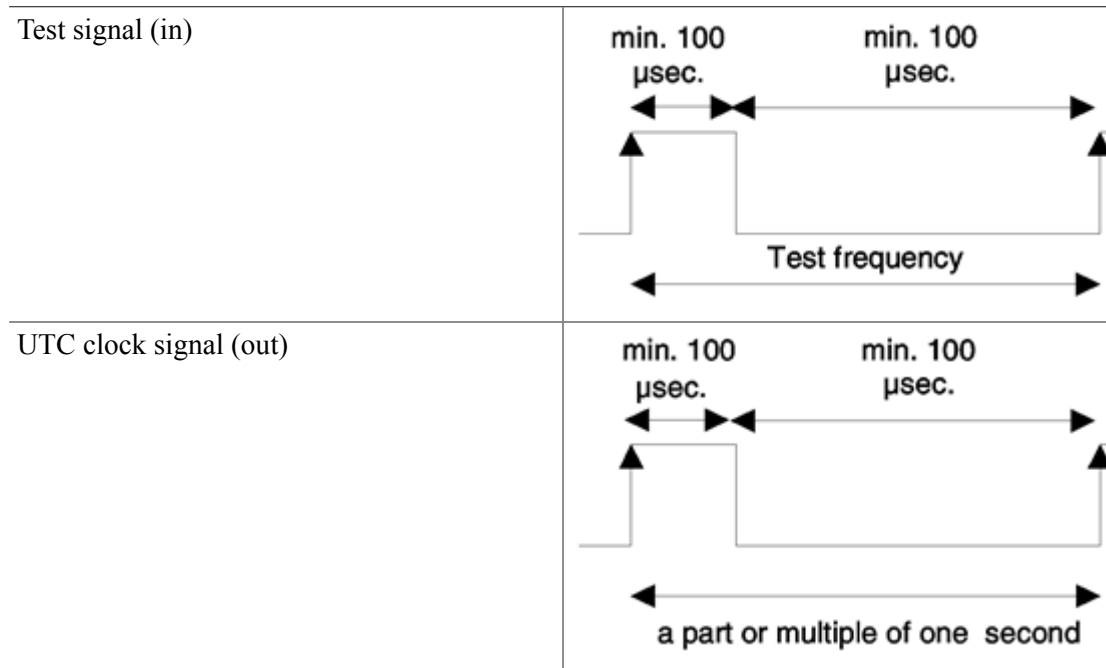



## Appendix 7

### DATA DOWNLOADING PROTOCOLS

#### 1. INTRODUCTION

This appendix specifies the procedures to follow in order to perform the different types of data download to an external storage medium, together with the protocols that must be implemented to assure the correct data transfer and the full compatibility of the downloaded data format to allow any controller to inspect these data and be able to control their authenticity and their integrity before analysing them.

##### 1.1. Scope

Data may be downloaded to an ESM:

- from a vehicle unit by an intelligent dedicated equipment (IDE) connected to the VU,
- from a tachograph card by an IDE fitted with a card interface device (IFD),
- from a tachograph card via a vehicle unit by an IDE connected to the VU.

To give the possibility to verify the authenticity and integrity of downloaded data stored on an ESM, data is downloaded with a signature appended in accordance with Appendix 11 Common Security Mechanisms. The source equipment (VU or card) identification and its security certificates (Member State and equipment) are also downloaded. The verifier of the data must possess independently a trusted European public key.

Data downloaded during one download session must be stored in the ESM within one file.

##### 1.2. Acronyms and notations

The following acronyms are used in this appendix:

AID	application identifier
ATR	answer to reset
CS	checksum byte
DF	dedicated file
DS_	diagnostic session
EF	elementary file
ESM	external storage medium
FID	file identifier (File ID)
FMT	format byte (first byte of message header)
ICC	integrated circuit card
IDE	intelligent dedicated equipment: The equipment used to perform data downloading to the ESM (e.g. personal computer)
IFD	interface device
KWP	keyword protocol 2000
LEN	length byte (last byte of message header)
PPS	protocol parameter selection
PSO	perform security operation
SID	service identifier
SRC	source byte
TGT	target byte
TLV	tag length value
TREP	transfer response parameter
TRTP	transfer request parameter

---

*Changes to legislation: There are currently no known outstanding effects for the Council Regulation (EEC) No 3821/85. (See end of Document for details)*

---

VU vehicle unit.

## 2. VU DATA DOWNLOADING

### 2.1. Download procedure

In order to carry on a VU data download, the operator must perform the following operations:

- insert his tachograph card inside a card slot of the VU<sup>(25)</sup>,
- connect the IDE to the VU download connector,
- establish the connection between the IDE and the VU,
- select on the IDE the data to download and send the request to the VU,
- close the download session.

### 2.2. Data download protocol

The protocol is structured on a master-slave basis, with the IDE playing the master role and the VU playing the slave role.

The message structure, types and flow are principally based on the Keyword Protocol 2000 (KWP) (ISO 14230-2 Road vehicles — Diagnostic systems — Keyword protocol 2000 — Part 2: Data link layer).

The application layer is principally based on the current draft to date of ISO 14229-1 (Road vehicles — Diagnostic systems — Part 1: Diagnostic services, version 6 of 22 February 2001).

#### 2.2.1. Message structure

All the messages exchanged between the IDE and the VU are formatted with a structure consisting of three parts:

- header composed by a format byte (FMT), a target byte (TGT), a source byte (SRC) and possibly a length byte (LEN),
- data field composed by a service identifier byte (SID) and a variable number of data bytes, which can include an optional diagnostic session byte (DS\_) or an optional transfer parameter byte (TRTP or TREP).
- checksum composed by a checksum byte (CS).

Header				Data field					Checksum
FMT	TGT	SRC	LEN	SID	DATA	...	...	...	CS
4 bytes				Max 225 bytes					1 byte

The TGT and SRC byte represent the physical address of the recipient and originator of the message. Values are F0 Hex for the IDE and EE Hex for the VU.

The LEN byte is the length of the data field part.

The checksum byte is the 8 bit sum series modulo 256 of all the bytes of the message excluding the CS itself.

FMT, SID, DS\_, TRTP and TREP bytes are defined later in this document.

In the case where the data to be carried by the message is longer than the space available in the data field part, the message is actually sent in several submessages. Each submessage bears a header, the same SID, TREP and a 2-byte submessage counter indicating the submessage number within the total message. To enable error checking and abort the IDE acknowledges

**Changes to legislation:** There are currently no known outstanding effects for the Council Regulation (EEC) No 3821/85. (See end of Document for details)

every submessage. The IDE can accept the submessage, ask for it to be re-transmitted, request the VU to start again or abort the transmission.

If the last submessage contains exactly 255 bytes in the data field, a final submessage with an empty (except SID TREP and submessage counter) data field must be appended to show the end of the message.

Example:

Header	SID	TREP	Message	CS
4 Bytes	Longer than 255 Bytes			

Will be transmitted as:

Header	SID	TREP	00	01	Submessage 1	CS
4 Bytes	255 Bytes					

Header	SID	TREP	00	01	Submessage 2	CS
4 Bytes	255 Bytes					

...

Header	SID	TREP	xx	yy	Submessage n	CS
4 Bytes	Less than 255 Bytes					

or as:

Header	SID	TREP	00	01	Submessage 1	CS
4 Bytes	255 Bytes					

Header	SID	TREP	00	02	Submessage 2	CS
4 Bytes	255 Bytes					

...

Header	SID	TREP	xx	yy	Submessage n	CS
4 Bytes	255 Bytes					

Header	SID	TREP	xx	yy+1	CS



**Changes to legislation:** There are currently no known outstanding effects for the Council Regulation (EEC) No 3821/85. (See end of Document for details)

Positive response request upload	80	F0	EE	03	75		00,FF	D5
Transfer data request								
Overview	80	EE	F0	02	36	01		97
Activities	80	EE	F0	06	36	02	Date	CS
Events and faults	80	EE	F0	02	36	03		99
Detailed speed	80	EE	F0	02	36	04		9A
Technical data	80	EE	F0	02	36	05		9B
Card download	80	EE	F0	02	36	06		9C
Positive response transfer data	80	F0	EE	Len	76	TREP	Data	CS
Request transfer exit	80	EE	F0	01	37			96
Positive response request transfer exit	80	F0	EE	01	77			D6
Stop communication request	80	EE	F0	01	82			E1
Positive response stop communication	80	F0	EE	01	C2			21
Acknowledge sub message	80	EE	F0	Len	83		Data	CS
Negative responses								
General reject	80	F0	EE	03	7F	Sid Req	10	CS
Service not supported	80	F0	EE	03	7F	Sid Req	11	CS
Subfunction not supported	80	F0	EE	03	7F	Sid Req	12	CS
Incorrect message length	80	F0	EE	03	7F	Sid Req	13	CS

Notes:

- Sid Req = the Sid of the corresponding request.
- TREP = the TRTP of the corresponding request.
- Dark cells denotes that nothing is transmitted.
- The term upload (as seen from the IDE) is used for compatibility with ISO 14229. It means the same as download (as seen from the VU).
- Potential 2-byte submessage counters are not shown in this Table.

*Changes to legislation: There are currently no known outstanding effects for the Council Regulation (EEC) No 3821/85. (See end of Document for details)*

Conditions not correct or request sequence error	80	F0	EE	03	7F	Sid Req	22	CS
Request out of range	80	F0	EE	03	7F	Sid Req	31	CS
Upload not accepted	80	F0	EE	03	7F	Sid Req	50	CS
Response pending	80	F0	EE	03	7F	Sid Req	78	CS
Data not available	80	F0	EE	03	7F	Sid Req	FA	CS

Notes:

- Sid Req = the Sid of the corresponding request.
- TREP = the TRTP of the corresponding request.
- Dark cells denotes that nothing is transmitted.
- The term upload (as seen from the IDE) is used for compatibility with ISO 14229. It means the same as download (as seen from the VU).
- Potential 2-byte submessage counters are not shown in this Table.

#### 2.2.2.1. Start communication request (SID 81)

This message is issued by the IDE to establish the communication link with the VU. Initial communications are always performed at 9 600 baud (until baud rate is eventually changed using the appropriate Link control services).

#### 2.2.2.2. Positive response start communication (SID C1)

This message is issued by the VU to answer positively to a start communication request. It includes the 2 key bytes [<sup>F22</sup>'EA' '8F'] indicating that the unit supports protocol with header including target source and length information.

#### 2.2.2.3. Start diagnostic session request (SID 10)

The start diagnostic session request message is issued by the IDE in order to request a new diagnostic session with the VU. The sub function 'default session' (81 Hex) indicates a standard diagnostic session is to be opened.

#### 2.2.2.4. Positive response start diagnostic (SID 50)

The positive response start diagnostic message is sent by the VU to answer positively to Diagnostic Session Request.

#### 2.2.2.5. Link control service (SID 87)

The link control service is used by the IDE to initiate a change in baud rate. This takes place in two steps. In step one the IDE proposes the baud rate change, indicating the new rate. On receipt of a positive message from the VU the IDE sends out confirmation of the baud rate change to the VU (step two). The IDE then changes to the new baud rate. After receipt of the confirmation the VU changes to the new baud rate

#### 2.2.2.6. Link control positive response (SID C7)

The link control positive response is issued by the VU to answer positively to Link Control Service request (step one). Note that no response is given to the confirmation request (step two).

#### 2.2.2.7. Request upload (SID 35)

The request upload message is issued by the IDE to specify to the VU that a download operation is requested. To meet the requirements of ISO14229 data is included covering address, the size and format details for the data requested. As these are not known to the IDE prior to a download, the memory address is set to 0, format is unencrypted and uncompressed and the memory size is set to the maximum.

#### 2.2.2.8. Positive response request upload (SID 75)

The positive response request upload message is sent by the VU to indicate to the IDE that the VU is ready to download data. To meet the requirements of ISO 14229 data is included in this positive response message, indicating to the IDE that further positive response transfer data messages will include 00FF hex bytes maximum.

#### 2.2.2.9. Transfer data request (SID 36)

The transfer data request is sent by the IDE to specify to the VU the type of data that are to be downloaded. A one byte transfer request parameter (TRTP) indicates the type of transfer.

There are six types of data transfer:

- overview (TRTP 01),
- activities of a specified date (TRTP 02),
- events and faults (TRTP 03),
- detailed speed (TRTP 04),
- technical data (TRTP 05),
- card download (TRTP 06).

It is mandatory for the IDE to request the overview data transfer (TRTP 01) during a download session as this only will ensure that the VU certificates are recorded within the downloaded file (and allow for verification of digital signature).

In the second case (TRTP 02) the transfer data request message includes the indication of the calendar day *TimeReal* format) to be downloaded.

#### 2.2.2.10. Positive response transfer data (SID 76)

The positive response transfer data is sent by the VU in response to the transfer data request. The message contains the requested data, with a transfer response parameter (TREP) corresponding to the TRTP of the request.

In the first case (TREP 01), the VU will send data helping the IDE operator to choose the data he wants to download further. The information contained within this message is:

- security certificates,
- vehicle identification,
- VU current date and time,
- minimum and maximum downloadable date (VU data),
- indication of cards presence in the VU,
- previous download to a company,
- company locks,
- previous controls.

---

*Changes to legislation: There are currently no known outstanding effects for the Council Regulation (EEC) No 3821/85. (See end of Document for details)*

---

#### 2.2.2.11. Request transfer exit (SID 37)

The request transfer exit message is sent by the IDE to inform the VU that the download session is terminated.

#### 2.2.2.12. Positive response request transfer exit (SID 77)

The positive response request transfer exit message is sent by the VU to acknowledge the Request Transfer Exit.

#### 2.2.2.13. Stop communication request (SID 82)

The stop communication request message is sent by the IDE to disconnect the communication link with the VU.

#### 2.2.2.14. Positive response stop communication (SID C2)

The positive response stop communication message is sent by the VU to acknowledge the stop communication request.

#### 2.2.2.15. Acknowledge submessage (SID 83)

The acknowledge sub message is sent by the IDE to confirm receipt of each part of a message that is being transmitted as several submessages. The data field contains the SID received from the VU and a 2-byte code as follows:

- MsgC +1 Acknowledges correct receipt of submessage number MsgC.
- Request from the IDE to the VU to send next submessage,
- MsgC indicates a problem with the receipt of submessage number MsgC.
- Request from the IDE to the VU to send the submessage again,
- FFFF requests termination of the message.

This can be used by the IDE to end the transmission of the VU message for any reason.

The last submessage of a message (LEN byte < 255) may be acknowledged using any of these codes or not acknowledged.

The VU responses that will consist of several sub messages are:

- positive response transfer Data (SID 76)

#### 2.2.2.16. Negative Response (SID 7F)

The negative response message is sent by the VU in response to the above request messages when the VU cannot satisfy the request. The data fields of the message contains the SID of the response (7F), the SID of the request, and a code specifying the reason of the negative response. The following codes are available:

- 10 general reject
  - The action cannot be performed for a reason not covered below
- 11 service not supported
  - The SID of the request is not understood
- 12 sub function not supported
  - The DS\_ or TRTP of the request is not understood, or there are no further sub messages to be transmitted



**Changes to legislation:** There are currently no known outstanding effects for the Council Regulation (EEC) No 3821/85. (See end of Document for details)

- 13 incorrect message length  
The length of the received message is wrong
- 22 conditions not correct or request sequence error  
The required service is not active or the sequence of request messages is not correct
- 31 request out of range  
The request parameter record (data field) is not valid
- 50 upload not accepted  
The request cannot be performed (VU in a non appropriate mode of operation or internal fault of the VU)
- 78 response pending  
The action requested cannot be completed in time and the VU is not ready to accept another request
- FA data not available  
The data object of a data transfer request are not available in the VU (e.g. no card is inserted, ...)

### 2.2.3. Message flow

A typical message flow during a normal data download procedure is the following:

IDE		[ <sup>X1</sup> VU]
Start communication request	⇒	
	⇐	Positive response
Start diagnostic service request	⇒	
	⇐	Positive response
Request upload	⇒	
	⇐	Positive response
Transfer data request overview	⇒	
	⇐	[ <sup>X1</sup> Positive response]
Data request #2	⇒	
	⇐	Positive response #1

*Changes to legislation: There are currently no known outstanding effects for the Council Regulation (EEC) No 3821/85. (See end of Document for details)*

Acknowledge submessage #1	⇒	
	⇐	Positive response #2
Acknowledge submessage #2	⇒	
	⇐	Positive response #m
Acknowledge submessage #m	⇒	
	⇐	Positive response (Data field < 255 Bytes)
Acknowledge submessage (optional)	⇒	
...		
Transfer data request #n	⇒	
	⇐	Positive response
Request transfer exit	⇒	
	⇐	Positive response
Stop communication request	⇒	
	⇐	Positive response

2.2.4. Timing

During normal operation the timing parameters shown in the following figure are relevant:

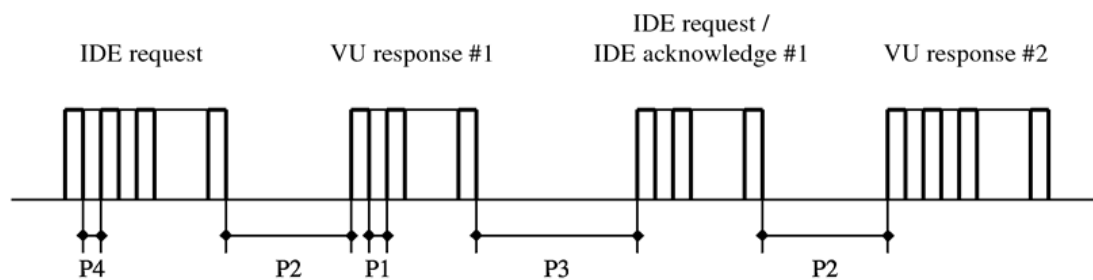

Where:

P1 = Inter byte time for VU response.

---

**Changes to legislation:** There are currently no known outstanding effects for the Council Regulation (EEC) No 3821/85. (See end of Document for details)

---

- P2 = Time between end of IDE request and start of VU response, or between end of IDE acknowledge and start of next VU response.
- P3 = Time between end of VU response and start of new IDE request, or between end of VU response and start of IDE acknowledge, or between end of IDE request and start of new IDE request if VU fails to respond.
- P4 = Inter byte time for IDE request.
- P5 = Extended value of P3 for card downloading.

The allowed values for the timing parameters are showed in the following table (KWP extended timing parameters set, used in case of physical addressing for faster communication).

TimingParameter	Lower limitValue (ms)	Upper limit value (ms)
P1	0	20
P2	20	1 000 <sup>a</sup>
P3	10	5 000
P4	5	20
P5	10	20 minutes

<sup>a</sup> If the VU responds with a negative response containing a code meaning 'request correctly received, response pending', this value is extended to the same upper limit value of P3.

### 2.2.5. Error handling

If an error occurs during the message exchange, the message flow scheme is modified depending on which equipment has detected the error and on the message generating the error.

In Figure 2 and Figure 3 the error handling procedures for the VU and the IDE are respectively shown.

#### 2.2.5.1. Start communication phase

If the IDE detects an error during the Start Communication phase, either by timing or by the bit stream, then it will wait for a period P3 min before issuing again the request.

If the VU detects an error in the sequence coming from the IDE, it shall send no response and wait for another Start Communication Request message within a period P3 max.

#### 2.2.5.2. Communication phase

Two different error handling areas can be defined:

##### 1. **The VU detects an IDE transmission error.**

For every received message the VU shall detect timing errors, byte format errors (e.g. start and stop bit violations) and frame errors (wrong number of bytes received, wrong checksum byte).

If the VU detects one of the above errors, then it sends no response and ignores the message received.

The VU may detect other errors in the format or content of the received message (e.g. message not supported) even if the message satisfies the length and checksum requirements; in such a case, the VU shall respond to the IDE with a Negative Response message specifying the nature of the error.

---

*Changes to legislation: There are currently no known outstanding effects for the Council Regulation (EEC) No 3821/85. (See end of Document for details)*

---

## 2. **The IDE detects a VU transmission error.**

For every received message the IDE shall detect timing errors, byte format errors (e.g. start and stop bit violations) and frame errors (wrong number of bytes received, wrong checksum byte).

The IDE shall detect sequence errors, e.g. incorrect sub message counter increments in successive received messages.

If the IDE detects an error or there was no response from the VU within a P2max period, the request message will be sent again for a maximum of three transmissions in total. For the purposes of this error detection a submessage acknowledge will be considered as a request to the VU.

The IDE shall wait at least for a period of P3min before beginning each transmission; the wait period shall be measured from the last calculated occurrence of a stop bit after the error was detected.

### 2.2.6. Response message content

This paragraph specifies the content of the data fields of the various positive response messages.

Data elements are defined in Appendix 1 data dictionary.

#### 2.2.6.1. Positive response transfer data overview

The data field of the 'positive response transfer data overview' message shall provide the following data in the following order under the SID 76 Hex, the TREP 01 Hex and appropriate sub message splitting and counting:

**Changes to legislation:** There are currently no known outstanding effects for the Council Regulation (EEC) No 3821/85. (See end of Document for details)

Data element	Length (Bytes)	Comment
MemberStateCertificate	194	VU Security certificates
VUCertificate	194	
VehicleIdentificationNumber	17	Vehicle identification
VehicleRegistrationIdentification	1	
vehicleRegistrationNation vehicleRegistrationNumber	14	
CurrentDateTime	4	VU current date and time
VuDownloadablePeriod		Downloadable period
minDownloadableTime maxDownloadableTime	4 4	
CardSlotsStatus	1	Type of cards inserted in the VU
VuDownloadActivityData		Previous VU download
downloadingTime	4	
fullCardNumber companyOrWorkshopName	18 36	
VuCompanyLocksData		All company locks stored. If the section is empty, only noOfLocks = 0 is sent.
noOfLocks	1	
...	(98)	
Vu Company Locks Record		
lockInTime	4	
lockOutTime	4	
companyName	36	
companyAddress	36	
companyCardNumber	18	
...		
VuControlActivityData		All control records stored in the VU. If the section is empty, only noOfControls = 0 is sent.
noOfControls	1	
...	(31)	
Vu Control Activity Record		
controlType	1	
controlTime	4	
controlCardNumber	18	
downloadPeriodBeginTime	4	
downloadPeriodEndTime	4	
...		
Signature	128	RSA signature of all data (except certificates) starting from VehicleIdentificationNumber down to last byte of last VuControlActivityRecord.

### 2.2.6.2. Positive response transfer data activities

The data field of the ‘positive response transfer data activities’ message shall provide the following data in the following order under the SID 76 Hex, the TREP 02 Hex and appropriate sub message splitting and counting:

*Changes to legislation: There are currently no known outstanding effects for the Council Regulation (EEC) No 3821/85. (See end of Document for details)*

Data element		Length (Bytes)	Comment
TimeReal		4	Date of day downloaded
OdometerValueMidnight		3	Odometer at end of downloaded day
VuCardIWData			Cards insertion withdrawal cycles data.
noOfVuCardIWRecords		2	— If this section contains no available data, only noOfVuCardIWRecords = 0 is sent. — When a VuCardIWRecord lies across 00:00 (card insertion on previous day) or across 24:00 (card withdrawal the following day) it shall appear in full within the two days involved.
...		(129)	
VuCardIWRecord	cardHolderName	36	
	holderSurname	36	
	holderFirstNames	18	
	fullCardNumber	4	
	cardExpiryDate	4	
	cardInsertionTime	3	
	vehicleOdometerValueAtInsertion	1	
	cardSlotNumber	4	
	cardWithdrawalTime	3	
	vehicleOdometerValueAtWithdrawal	3	
	previousVehicleInfo		
	vehicleRegistrationIdentification	1	
	vehicleRegistrationNation	14	
vehicleRegistrationNumber	4		
cardWithdrawalTime	1		
manualInputFlag			
...			
VuActivityDailyData			Slots status at 00:00 and activity changes recorded for the day downloaded.
noOfActivityChanges		2	
...			
ActivityChangeInfo		2	
...			
VuPlaceDailyWorkPeriodData			Places related data recorded for the day downloaded. If the section is empty, only noOfPlaceRecords = 0 is sent.
noOfPlaceRecords		1	
...		(28)	
VuPlaceDailyWorkPeriodRecord	fullCardNumber	18	
	placeRecord	4	
	entryTime	1	
	entryTypeDailyWorkPeriod	1	
	dailyWorkPeriodCountry	1	
	dailyWorkPeriodRegion	3	
vehicleOdometerValue			
...			
VuSpecificConditionData			Specific conditions data recorded for the day downloaded. If the section is empty, only noOfSpecificConditionRecords = 0 is sent
noOfSpecificConditionRecords		2	
...		(5)	
SpecificConditionRecord			
EntryTime	4		
specificConditionType	1		
...			
Signature		128	RSA signature of all data starting from TimeReal down to last byte of last specific condition record.

---

**Changes to legislation:** There are currently no known outstanding effects for the Council Regulation (EEC) No 3821/85. (See end of Document for details)

---

### 2.2.6.3. Positive response transfer data events and faults

The data field of the 'positive response transfer data events and faults' message shall provide the following data in the following order under the SID 76 Hex, the TREP 03 Hex and appropriate sub message splitting and counting:

*Changes to legislation: There are currently no known outstanding effects for the Council Regulation (EEC) No 3821/85. (See end of Document for details)*

Data element		Length (Bytes)	Comment
VuFaultData			All faults stored or on-going in the VU. If the section is empty, only noOfVuFaults = 0 is sent.
NoOfVuFaults		1	
...		(82)	
VuFaultRecord	FaultType	1	
	FaultRecordPurpose	1	
	FaultBeginTime	4	
	FaultEndTime	4	
	CardNumberDriverSlotBegin	18	
	cardNumberCodriverSlotBegin	18	
CardNumberDriverSlotEnd	18		
CardNumberCodriverSlotEnd	18		
...			
VuEventData			
NoOfVuEvents		1	
...		(83)	
VuEventRecord	EventType	1	
	EventRecordPurpose	1	
	EventBeginTime	4	
	EventEndTime	4	
	CardNumberDriverSlotBegin	18	
	cardNumberCodriverSlotBegin	18	
	CardNumberDriverSlotEnd	18	
	CardNumberCodriverSlotEnd	18	
SimilarEventsNumber	1		
...			
VuOverSpeedingControlData			Data related to last over speeding control (default value if no data).
LastOverspeedControlTime		4	
FirstOverspeedSince		4	
NumberOfOverspeedSince		1	
VuOverSpeedingEventData			All over speeding events stored in the VU. If the section is empty, only noOfVuOverSpeedingEvents = 0 is sent.
NoOfVuOverSpeedingEvents		1	
...		(31)	
VuOverSpeedingEventRecord	EventType	1	
	EventRecordPurpose	1	
	EventBeginTime	4	
	EventEndTime	4	
	MaxSpeedValue	1	
	AverageSpeedValue	1	
	CardNumberDriverSlotBegin	18	
	SimilarEventsNumber	1	
...			
VuTimeAdjustmentData			All time adjustment events stored in the VU (outside the frame of a full calibration). If the section is empty, only noOfVuTimeAdjRecords = 0 is sent.
NoOfVuTimeAdjRecords		1	
...		(98)	
VuTimeAdjustmentRecord	OldTimeValue	4	
	NewTimeValue	4	
	WorkshopName	36	
	WorkshopAddress	36	
WorkshopCardNumber	18		
...			
Signature		128	RSA signature of all data starting from noOfVuFaults down to last byte of last time adjustment record.



**Changes to legislation:** There are currently no known outstanding effects for the Council Regulation (EEC) No 3821/85. (See end of Document for details)

#### 2.2.6.4. Positive response transfer data detailed speed

The data field of the ‘positive response transfer data detailed speed’ message shall provide the following data in the following order under the SID 76 Hex, the TREP 04 Hex and appropriate sub message splitting and counterling:

Data element		Length (Bytes)	Comment
VuDetailedSpeedData			
NoOfSpeedBlocks		2	All detailed speed stored in the VU (one speed block per minute during which the vehicle has been moving) 60 speed values per minute (one per second).
...			
VuDetailedSpeedBlock	SpeedBlockBeginDate speedsPerSecond	4 60	
...			
Signature		128	RSA signature of all data starting from noOfSpeedBlocks down to last byte of last speed block.

#### 2.2.6.5. Positive response transfer data technical data

The data field of the ‘positive response transfer data technical data’ message shall provide the following data in the following order under the SID 76 Hex, the TREP 05 Hex and appropriate sub message splitting and counting:

*Changes to legislation: There are currently no known outstanding effects for the Council Regulation (EEC) No 3821/85. (See end of Document for details)*

Data element	Length (Bytes)	Comment
VuIdentification		
vuManufacturerName	36	
vuManufacturerAddress	36	
vuPartNumber	16	
vuSerialNumber	8	
vuSoftwareIdentification		
vuSoftwareVersion	4	
vuSoftInstallationDate	4	
vuManufacturingDate	4	
vuApprovalNumber	8	
SensorPaired		
sensorSerialNumber	8	
sensorApprovalNumber	8	
sensorPairingDateFirst	4	
VuCalibrationData		All calibration records stored in the VU.
noOfVuCalibrationRecords	1	
...	► <sup>(n)</sup> (167)◀	
VuCalibrationRecord		
calibrationPurpose	1	
workshopName	36	
workshopAddress	36	
workshopCardNumber	18	
workshopCardExpiryDate	4	
vehicleIdentificationNumber	17	
vehicleRegistrationIdentification		
vehicleRegistrationNation	1	
vehicleRegistrationNumber	14	
wVehicleCharacteristicConstant	2	
kConstantOfRecordingEquipment	2	
lTyreCircumference	2	
tyreSize	15	
authorisedSpeed	1	
oldOdometerValue	3	
newOdometerValue	3	
oldTimeValue	4	
newTimeValue	4	
nextCalibrationDate	4	
...		
Signature	128	RSA signature of all data starting from vuManufacturerName down to last byte of last VuCalibrationRecord.

### 2.3. ESM File storage

When a download session has included a VU data transfer, the IDE shall store within one physical file all data received from the VU during the download session within positive response transfer data messages. Data stored excludes message headers, sub-message counters, empty sub-messages and checksums but include the SID and TREP (of the first sub-message only if several sub-messages).

## 3. TACHOGRAPH CARDS DOWNLOADING PROTOCOL

### 3.1. Scope

This paragraph describes the direct card data downloading of a tachograph card to an IDE. The IDE is not part of the secure environment; therefore no authentication between the card and the IDE is performed.

### 3.2. Definitions

**Changes to legislation:** There are currently no known outstanding effects for the Council Regulation (EEC) No 3821/85. (See end of Document for details)

- Download session** : Each time a download of the ICC data is performed. The session covers the complete procedure from the reset of the ICC by an IFD until the deactivation of the ICC (withdraw of the card or next reset).
- Signed data file** : A file from the ICC. The file is transferred to the IFD in plain text. On the ICC the file is hashed and signed and the signature is transferred to the IFD.

### 3.3. Card downloading

The download of a tachograph card includes the following steps:

- download the common information of the card in the EFs *ICC* and *IC*. This information is optional and is not secured with a digital signature,
- Download the EFs *Card\_Certificate* and *CA\_Certificate*. This information is not secured with a digital signature,

It is mandatory to download these files for each download session.

- download the other application data EFs (within Tachograph DF) except EF *Card\_Download*. This information is secured with a digital signature,
  - it is mandatory to download at least the EFs *Application\_Identification* and *ID* for each download session,
  - when downloading a driver card it is also mandatory to download the following EFs:
    - *Events\_Data*,
    - *Faults\_Data*,
    - *Driver\_Activity\_Data*,
    - *Vehicles\_Used*,
    - *Places*,
    - *Control\_Activity\_Data*,
    - *Specific\_Conditions*.
- When downloading a driver card, update the *LastCardDownload* date in EF *Card\_Download*,
- When downloading a workshop card, reset the calibration counter in EF *Card\_Download*.

#### 3.3.1. Initialisation sequence

The IDE shall initiate the sequence as follows:

Card	Direction	IDE/IFD	Meaning/Remarks
	↶	Hardware reset	
ATR	↷		

It is optional to use PPS to switch to a higher baudrate as long as the ICC supports it.

#### 3.3.2. Sequence for unsigned data files

The sequence to download the *ICC*, *IC*, *Card\_Certificate* and *CA\_Certificate* is as follows:

Card	Direction	IDE/IFD	Meaning/Remarks
------	-----------	---------	-----------------

**Changes to legislation:** There are currently no known outstanding effects for the Council Regulation (EEC) No 3821/85. (See end of Document for details)

	↶	Select file	Select file select by file identifiers
OK	↷		
	↶	Read Binary	If the file contains more data than the buffer size of the reader or the card the command has to be repeated until the complete file is read.
File data OK	↷	Store data to ESM	according to 3.4, (Data storage format)

Note: Before selecting the *Card\_Certificate* EF, the Tachograph Application must be selected (selection by AID).

### 3.3.3. Sequence for signed data files

The following sequence shall be used for each of the following files that has to be downloaded with their signature:

Card	Direction	IDE/IFD	Meaning/Remarks
	↶	Select File	
OK	↷		
	↶	Perform hash of File	Calculates the hash value over the data content of the selected file using the prescribed hash algorithm in accordance with Appendix 11. This command is not an ISO-Command.
Calculate hash of file and store hash value temporarily			
OK	↷		
	↶	Read Binary	If the file contains more data than the buffer of the reader or the card can hold, the command has to

**Changes to legislation:** There are currently no known outstanding effects for the Council Regulation (EEC) No 3821/85. (See end of Document for details)

			be repeated until the complete file is read.
File Data OK	⇒	Store received data to ESM	according to 3.4, (Data storage format)
	⇐	PSO: Compute digital signature	
Perform security operation 'compute digital signature' using the temporarily stored hash value			
Signature OK	⇒	Append data to the previous stored data on the ESM	according to 3.4, (Data storage format)

### 3.3.4. Sequence for resetting the calibration counter

The sequence to reset the *NoOfCalibrationsSinceDownload* counter in the EF *Card\_Download* in a workshop card is the following:

Card	Direction	IDE/IFD	Meaning/Remarks
	⇐	Select File EF <i>Card_Download</i>	Select by file identifiers
OK	⇒		
	⇐	Update Binary <i>NoOfCalibrationsSinceDownload</i> = '00 00'	
Resets card download number			
OK	⇒		

## 3.4. Data storage format

### 3.4.1. Introduction

The downloaded data has to be stored according to the following conditions:

- the data shall be stored transparent. This means that the order of the bytes as well as the order of the bits inside the byte that are transferred from the card has to be preserved during storage,
- all files of the card downloaded within a download session are stored in one file on the ESM.

### 3.4.2. File format

The file format is a concatenation of several TLV objects.

*Changes to legislation: There are currently no known outstanding effects for the Council Regulation (EEC) No 3821/85. (See end of Document for details)*

The tag for an EF shall be the FID plus the appendix '00'.

The tag of an EF's signature shall be the FID of the file plus the appendix '01'.

The length is a two byte value. The value defines the number of bytes in the value field. The value 'FF FF' in the length field is reserved for future use.

When a file is not downloaded nothing related to the file shall be stored (no tag and no zero length).

A signature shall be stored as the next TLV object directly after the TLV object that contains the data of the file.

Definition	Meaning	Length
FID (2 Bytes)    '00'	Tag for EF (FID)	3 Bytes
FID (2 Bytes)    '01'	Tag for Signature of EF(FID)	3 Bytes
xx xx	Length of value field	2 Bytes

Example of data in a download file on an ESM:

Tag	Length	Value
00 02 00	00 11	Data of EF <i>ICC</i>
C1 00 00	00 C2	Data of EF <i>Card_Certificate</i>
		...
05 05 00	0A 2E	Data of EF <i>Vehicles_Used</i>
05 05 01	00 80	Signature of EF <i>Vehicles_Used</i>

#### 4. DOWNLOADING A TACHOGRAPH CARD VIA A VEHICLE UNIT

The VU must allow for downloading the content of a driver card inserted to a connected IDE.

The IDE shall send a 'transfer data request card download' message to the VU to initiate this mode (see 2.2.2.9).

The VU shall then download the whole card, file by file, in accordance with the card downloading protocol defined in paragraph 3, and forward all data received from the card to the IDE within the appropriate TLV file format (see 3.4.2) and encapsulated within a 'positive response transfer data' message.

The IDE shall retrieve card data from the 'positive response transfer data' message (stripping all headers, SIDs, TREPs, submessage counters, and checksums) and store them within one physical file as described in paragraph 2.3.

The VU shall then, as applicable, update the *Control\_Activity\_Data* or the *Card\_Download* file of the driver card.

## Appendix 8

### CALIBRATION PROTOCOL

#### 1. INTRODUCTION

This appendix describes how data is exchanged between a vehicle unit and a tester via the K-line which forms part of the calibration interface described in Appendix 6. It also describes control of the input/output signal line on the calibration connector.

Establishing K-line communications is described in Section 4 ‘Communication Services’.

This appendix uses the idea of diagnostic ‘sessions’ to determine the scope of K-line control under different conditions. The default session is the ‘StandardDiagnosticSession’ where all data can be read from a vehicle unit but no data can be written to a vehicle unit.

Selection of the diagnostic session is described in Section 5 ‘Management Services’.

The ‘ECUProgrammingSession’ allows data entry into the vehicle unit. In the case of entry of calibration data (requirements 097 and 098), the vehicle unit must, in addition be in the CALIBRATION mode of operation.

Data transfer via K-line is described in Section 6 ‘Data Transmission Services’. Formats of data transferred are detailed in Section 8 ‘dataRecords formats’.

The ‘ECUAdjustmentSession’ allows the selection of the I/O mode of the calibration I/O signal line via the K-line interface. Control of the calibration I/O signal line is described in section 7 ‘Control of Test Pulses — Input/Output Control functional unit’.

Throughout this document the address of the tester is referred to as ‘tt’. Although there may be preferred addresses for testers, the VU shall respond correctly to any tester address. The physical address of the VU is 0xEE.

#### 2. TERMS, DEFINITIONS AND REFERENCES

The protocols, messages and error codes are principally based on the current draft to date of ISO 14229-1 (Road vehicles — Diagnostic systems — Part 1: Diagnostic services, version 6 of 22 February 2001).

Byte encoding and hexadecimal values are used for the service identifiers, the service requests and responses, and the standard parameters.

The term ‘tester’ refers to the equipment used to enter programming/calibration data into the VU.

The terms ‘client’ and ‘server’ refer to the tester and the VU respectively.

The term ECU means ‘Electronic Control Unit’ and refers to the VU.

#### References:

ISO 14230-2 : Road Vehicles — Diagnostic Systems — Keyword Protocol 2000- Part 2: Data Link Layer. First edition: 1999. Vehicles — Diagnostic Systems.

#### 3. OVERVIEW OF SERVICES

##### 3.1. Services available

*Changes to legislation: There are currently no known outstanding effects for the Council Regulation (EEC) No 3821/85. (See end of Document for details)*

The following table provides an overview of the services that will be available in the recording equipment and are defined in this document.

The table indicates the services that are available in an enabled diagnostic session.

- The first column lists the services that are available,
- the second column includes the section number in this appendix where of service is further defined,
- the third column assigns the service identifier values for request messages,
- the fourth column specifies the services of the ‘StandardDiagnosticSession’ (SD) which must be implemented in each VU,
- the fifth column specifies the services of the ‘ECUAdjustmentSession’ (ECUAS) which must be implemented to allow control of the I/O signal line in the front panel calibration connector of the VU,
- the sixth column specifies the services of the ‘ECUProgrammingSession’ (ECUPS) which must be implemented to allow for programming of parameters in the VU.

TABLE 1

Service Identifier value summary table

Diagnostic Service Name	Section No	Sid Req.Value	Diagnostic Sessions		
			SD	ECUAS	ECUPS
StartCommunication		81	a	a	a
StopCommunication		82	a		
TesterPresent	4.3	3E	a	a	a
StartDiagnosticSession		10	a	a	a
SecurityAccess	5.2	27	a	a	a
ReadDataByIdentifier		22	a	a	a
WriteDataByIdentifier		2E			a
InputOutputControlByIdentifier		2F		a	

a ■ This symbol indicates that the service is mandatory in this diagnostic session. No symbol indicates that this service is not allowed in this diagnostic session.

### 3.2. Response codes

Response codes are defined for each service.

## 4. COMMUNICATION SERVICES

Some services are necessary to establish and maintain communication. They do not appear on the application layer. The services available are detailed in the following table:

TABLE 2

Communication services

Service name	Description
--------------	-------------



---

**Changes to legislation:** There are currently no known outstanding effects for the Council Regulation (EEC) No 3821/85. (See end of Document for details)

---

StartCommunication	The client requests to start a communication session with a server(s)
StopCommunication	The client requests to stop the current communication session
TesterPresent	The client indicates to the server that it is still present

The StartCommunication Service is used for starting a communication. In order to perform any service, communication must be initialised and the communication parameters need to be appropriate for the desired mode.

#### 4.1. StartCommunication Service

Upon receiving a StartCommunication indication primitive, the VU shall check if the requested communication link can be initialised under the present conditions. Valid conditions for the initialisation of a communication link are described in document ISO 14230-2.

Then the VU shall perform all actions necessary to initialise the communication link and send a StartCommunication response primitive with the positive response parameters selected.

If a VU that is already initialised (and has entered any diagnostic session) receives a new StartCommunication request (e.g. due to error recovery in the tester) the request shall be accepted and the VU shall be re-initialised.

If the communication link cannot be initialised for any reason, the VU shall continue operating as it was immediately prior to the attempt to initialise the communication link.

The StartCommunication Request message must be physically addressed.

Initialising the VU for services is performed through a 'fast initialisation' method,

- there is a bus-idle time prior to any activity,
- the tester then sends an initialisation pattern,
- all information which is necessary to establish communication is contained in the response of the VU.

After completion of the initialisation,

- all communication parameters are set to values defined in Table 4 according to the key bytes,
- the VU is waiting for the first request of the tester,
- the VU is in the default diagnostic mode, i.e. StandardDiagnosticSession,
- the calibration I/O signal line is in the default state, i.e. disabled state.

The data rate on the K-line shall be 10 400 Baud.

The fast initialisation is started by the tester transmitting a wake-up pattern (Wup) on the K-line. The pattern begins after the idle time on K-line with a low time of  $T_{inil}$ . The tester transmits the first bit of the StartCommunication Service after a time of  $T_{wup}$  following the first falling edge.

**Changes to legislation:** There are currently no known outstanding effects for the Council Regulation (EEC) No 3821/85. (See end of Document for details)

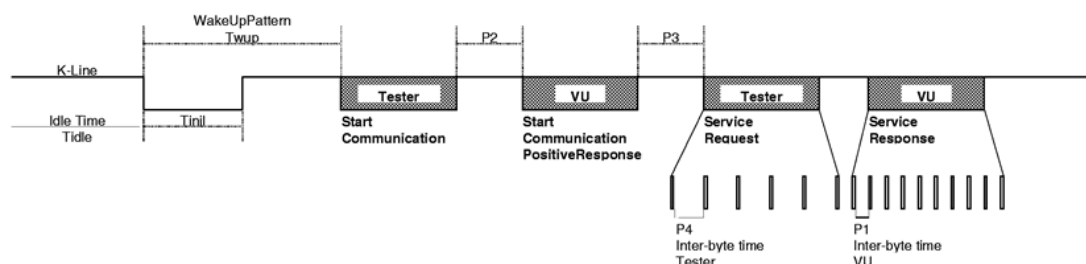

The timing values for the fast initialisation and communications in general are detailed in the tables below. There are different possibilities for the idle time:

- first transmission after power on,  $T_{idle} = 300$  ms.
- after completion of a StopCommunication Service,  $T_{idle} = P3$  min.
- [<sup>X1</sup>After stopping communication by time-out P3 max,  $T_{idle} = 0$ .]

TABLE 3

Timing values for fast initialisation

Parameter		minimum value	maximum value
Tinil	$25 \pm 1$ ms	24 ms	26 ms
Twup	$50 \pm 1$ ms	49 ms	51 ms

TABLE 4

Communication timing values

Timing parameter	Parameter description	Lower limit values (ms)	Upper limit values (ms)
		minimum	maximum
P1	Inter byte time for VU response	0	20
P2	Time between tester request and VU response or two VU responses	25	250
P3	Time between end of VU responses and start of new tester request	55	5 000
P4	Inter byte time for tester request	5	20

The message format for fast initialisation is detailed in the following tables:

TABLE 5

StartCommunication request message

Byte #	Parameter Name	Hex value	Mnemonic
--------	----------------	-----------	----------

*Changes to legislation: There are currently no known outstanding effects for the Council Regulation (EEC) No 3821/85. (See end of Document for details)*

#1	Format byte — physical addressing	81	FMT
#2	Target address byte	EE	TGT
#3	Source address byte	tt	SRC
#4	StartCommunication Request Service	81	SCR
#5	Checksum	00-FF	CS

TABLE 6

StartCommunication positive response message

Byte #	Parameter Name	Hex value	Mnemonic
#1	Format byte — physical addressing	80	FMT
#2	Target address byte	tt	TGT
#3	Source address byte	EE	SRC
#4	Additional length byte	03	LEN
#5	StartCommunication Positive Response Service Id	C1	SCRPR
#6	Key byte 1	EA	KB1
#7	Key byte 2	8F	KB2
#8	Checksum	00-FF	CS

There is no negative response to the StartCommunication Request message, if there is no positive response message to be transmitted then the VU is not initialised, nothing is transmitted and it remains in its normal operation.

#### 4.2. StopCommunication service

##### 4.2.1. Message description

The purpose of this communication layer service is to terminate a communication session.

Upon receiving a StopCommunication indication primitive, the VU shall check if the current conditions allow to terminate this communication. In this case the VU shall perform all actions necessary to terminate this communication.

If it is possible to terminate the communication, the VU shall issue a StopCommunication response primitive with the Positive Response parameters selected, before the communication is terminated.

If the communication cannot be terminated by any reason, the VU shall issue a StopCommunication response primitive with the Negative Response parameter selected.

If time -out of P3max is detected by the VU, the communication shall be terminated without any response primitive being issued.

*Changes to legislation: There are currently no known outstanding effects for the Council Regulation (EEC) No 3821/85. (See end of Document for details)*

#### 4.2.2. Message format

The message formats for the StopCommunication primitives are detailed in the following tables:

TABLE 7

##### StopCommunication request message

Byte #	Parameter Name	Hex value	Mnemonic
#1	Format byte — physical addressing	80	FMT
#2	Target address byte	EE	TGT
#3	Source address byte	tt	SRC
#4	Additional length byte	01	LEN
#5	StopCommunication Request Service Id	82	SPR
#6	Checksum	00-FF	CS

TABLE 8

##### StopCommunication positive response message

Byte #	Parameter Name	Hex value	Mnemonic
#1	Format byte — physical addressing	80	FMT
#2	Target address byte	tt	TGT
#3	Source address byte	EE	SRC
#4	Additional length byte	01	LEN
#5	StopCommunication Positive Response Service	C2	SPRPR
#6	Checksum	00-FF	CS

TABLE 9

##### StopCommunication negative response message

Byte #	Parameter Name	Hex value	Mnemonic
#1	Format byte — physical addressing	80	FMT
#2	Target address byte	tt	TGT
#3	Source address byte	EE	SRC
#4	Additional length byte	03	LEN

*Changes to legislation: There are currently no known outstanding effects for the Council Regulation (EEC) No 3821/85. (See end of Document for details)*

#5	negative Response Service Id	7F	NR
#6	StopCommunication Request Service Identification	82	SPR
#7	responseCode = generalReject	10	RC_GR
#8	Checksum	00-FF	CS

#### 4.2.3. Parameter definition

This service does not require any parameter definition.

#### 4.3. TesterPresent service

##### 4.3.1. Message description

The TesterPresent service is used by the tester to indicate to the server that it is still present, in order to prevent the server from automatically returning to normal operation and possibly stopping the communication. This service, sent periodically, keeps the diagnostic session/communication active by resetting the P3 timer each time a request for this service is received.

##### 4.3.2. Message format

The message formats for the TesterPresent primitives are detailed in the following tables.

TABLE 10

#### TesterPresent request message

Byte #	Parameter Name	Hex value	Mnemonic
#1	Format byte — physical addressing	80	FMT
#2	Target address byte	EE	TGT
#3	Source address byte	tt	SRC
#4	Additional length byte	02	LEN
#5	TesterPresent Request Service Id	3E	TP
#6	Sub Function = responseRequired = [yes no]	01 02	RESPREQ_Y RESPREQ_NO
#7	Checksum	00-FF	CS

If the responseRequired parameter is set to 'yes', then the server shall respond with the following positive response message. If set to 'no', then no response is sent by the server.

*Changes to legislation: There are currently no known outstanding effects for the Council Regulation (EEC) No 3821/85. (See end of Document for details)*

TABLE 11

TesterPresent positive response message

Byte #	Parameter Name	Hex value	Mnemonic
#1	Format byte — physical addressing	80	FMT
#2	Target address byte	tt	TGT
#3	Source address byte	EE	SRC
#4	Additional length byte	01	LEN
#5	TesterPresent Positive Response Service Id	7E	TPPR
#6	Checksum	00-FF	CS

The service shall support the following negative responses codes:

TABLE 12

TesterPresent negative response message

Byte #	Parameter Name	Hex value	Mnemonic
#1	Format byte — physical addressing	80	FMT
#2	Target address byte	tt	TGT
#3	Source address byte	EE	SRC
#4	Additional length byte	03	LEN
#5	negative Response Service Id	7F	NR
#6	TesterPresent Request Service Identification	3E	TP
#7	responseCode = [SubFunctionNotSupported-InvalidFormat incorrectMessageLength]	12	RC_SFNS_IF RC_IML
#8	Checksum	00-FF	CS

## 5. MANAGEMENT SERVICES

The services available are detailed in the following table:

TABLE 13

Management services

Service name	Description
--------------	-------------

*Changes to legislation: There are currently no known outstanding effects for the Council Regulation (EEC) No 3821/85. (See end of Document for details)*

StartDiagnosticSession	The client requests to start a diagnostic session with a VU
SecurityAccess	The client requests access to functions restricted to authorised users

## 5.1. StartDiagnosticSession service

### 5.1.1. Message description

The service StartDiagnosticSession is used to enable different diagnostic sessions in the server. A diagnostic session enables a specific set of services according to Table 17. A session can enable vehicle manufacturer specific services which are not part of this document. Implementation rules shall conform to the following requirements:

- there shall be always exactly one diagnostic session active in the VU,
- the VU shall always start the StandardDiagnosticSession when powered up. If no other diagnostic session is started, then the StandardDiagnosticSession shall be running as long as the VU is powered,
- if a diagnostic session which is already running has been requested by the tester, then the VU shall send a positive response message,
- whenever the tester requests a new diagnostic session, the VU shall first send a StartDiagnosticSession positive response message before the new session becomes active in the VU. If the VU is not able to start the requested new diagnostic session, then it shall respond with a StartDiagnosticSession negative response message, and the current session shall continue.

The diagnostic session shall only be started if communication has been established between the client and the VU.

The timing parameters defined in Table 4 shall be active after a successful StartDiagnosticSession with the diagnosticSession parameter set to 'StandardDiagnosticSession' in the request message if another diagnostic session was previously active.

### 5.1.2. Message format

The message formats for the StartDiagnosticSession primitives are detailed in the following tables:

TABLE 14

#### StartDiagnosticSession request message

Byte #	Parameter Name	Hex value	Mnemonic
#1	Format byte — physical addressing	80	FMT
#2	Target address byte	EE	TGT
#3	Source address byte	tt	SRC
#4	Additional length byte	02	LEN
#5	StartDiagnosticSession request service Id	10	STDS

*Changes to legislation: There are currently no known outstanding effects for the Council Regulation (EEC) No 3821/85. (See end of Document for details)*

#6	diagnosticSession = (one value from Table 17)	xx	DS_ ...
#7	Checksum	00-FF	CS

TABLE 15

## StartDiagnosticSession positive response message

Byte #	Parameter Name	Hex value	Mnemonic
#1	Format byte — physical addressing	80	FMT
#2	Target address byte	tt	TGT
#3	Source address byte	EE	SRC
#4	Additional length byte	02	LEN
#5	StartDiagnosticSession Positive Response Service Id	50	STDSPR
#6	DiagnosticSession = (same value as in byte #6 Table 14)	xx	DS_ ...
#7	Checksum	00-FF	CS

TABLE 16

## StartDiagnosticSession negative response message

Byte #	Parameter Name	Hex value	Mnemonic
#1	Format byte — physical addressing	80	FMT
#2	Target address byte	tt	TGT
#3	Source address byte	EE	SRC
#4	Additional length byte	03	LEN
#5	Negative response service Id	7F	NR
#6	StartDiagnosticSession request service Id	10	STDS
#7	ResponseCode = (subFunctionNotSupported <sup>a</sup> incorrectMessageLength <sup>b</sup> )	12	RC_SFNS RC_IML

**a** The value inserted in byte #6 of the request message is not supported, i.e. not in Table 17.

**b** The length of the message is wrong.

**c** The criteria for the request StartDiagnosticSession are not met.



**Changes to legislation:** There are currently no known outstanding effects for the Council Regulation (EEC) No 3821/85. (See end of Document for details)

	conditionsNotCorrect <sup>c)</sup>	22	RC_CNC
#8	Checksum	00-FF	CS
a	The value inserted in byte #6 of the request message is not supported, i.e. not in Table 17.		
b	The length of the message is wrong.		
c	The criteria for the request StartDiagnosticSession are not met.		

### 5.1.3. Parameter definition

The parameter *diagnosticSession* (*DS*) is used by the StartDiagnosticSession service to select the specific behaviour of the server(s). The following diagnostic sessions are specified in this document:

TABLE 17

#### Definition of diagnosticSession values

Hex	Description	Mnemonic
81	StandardDiagnosticSession This diagnostic session enables all services specified in Table 1 column 4 'SD'. These services allow reading of data from a server (VU). This diagnostic Session is active after the initialisation has been successfully completed between client (tester) and server (VU). This diagnostic session may be overwritten by other diagnostic sessions specified in this section.	SD
85	ECUProgrammingSession This diagnostic session enables all services specified in Table 1 column 6 'ECUPS'. These services support the memory programming of a server (VU) This diagnostic session may be overwritten by other diagnostic sessions specified in this section.	ECUPS
87	ECUAdjustmentSession This diagnostic session enables all services specified in Table 1 column 5 'ECUAS'. These services support the input/output control of a server (VU).	ECUAS

---

*Changes to legislation: There are currently no known outstanding effects for the Council Regulation (EEC) No 3821/85. (See end of Document for details)*

---

This diagnostic session may be overwritten by other diagnostic sessions specified in this section.
--

---

## 5.2. SecurityAccess service

Writing of calibration data or access to the calibration input/output line is not possible unless the VU is in CALIBRATION mode. In addition to insertion of a valid workshop card into the VU, it is necessary to enter the appropriate PIN into the VU before access to the CALIBRATION mode is granted.

The SecurityAccess service provides a means to enter the PIN and to indicate to the tester whether or not the VU is in CALIBRATION mode.

It is acceptable that the PIN may be entered through alternative methods.

### 5.2.1. Message description

The SecurityAccess service consists of a SecurityAccess 'requestSeed' message, eventually followed by a SecurityAccess 'sendKey' message. The SecurityAccess service must be carried out after the StartDiagnosticSession service.

The tester shall use the SecurityAccess "requestSeed" message to check if the vehicle unit is ready to accept a PIN.

If the vehicle unit is already in CALIBRATION mode, it shall answer the request by sending a 'seed' of 0x0000 using the service SecurityAccess Positive Response.

If the vehicle unit is ready to accept a PIN for verification by a workshop card, it shall answer the request by sending a 'seed' greater than 0x0000 using the service SecurityAccess positive response.

If the vehicle unit is not ready to accept a PIN from the tester, either because the workshop card inserted is not valid, or because no workshop card has been inserted, or because the vehicle unit expects the PIN from another method, it shall answer the request with a negative response with a response code set to conditionsNotCorrectOrRequestSequenceError.

The tester shall then, eventually, use the SecurityAccess 'sendKey' message to forward a PIN to the Vehicle Unit. To allow time for the card authentication process to take place, the VU shall use the negative response code requestCorrectlyReceived-ResponsePending to extend the time to respond. However, the maximum time to respond shall not exceed five minutes. As soon as the requested service has been completed, the VU shall send a positive response message or negative response message with a response code different from this one. The negative response code requestCorrectlyReceived-ResponsePending may be repeated by the VU until the requested service is completed and the final response message is sent.

The vehicle unit shall answer to this request using the service SecurityAccess Positive Response only when in CALIBRATION mode.

In the following cases, the vehicle unit shall answer to this request with a Negative Response with a response code set to:

- subFunctionNot supported: invalid format for the subfunction parameter (accessType),
- conditionsNotCorrectOrRequestSequenceError: vehicle unit not ready to accept a PIN entry,

*Changes to legislation: There are currently no known outstanding effects for the Council Regulation (EEC) No 3821/85. (See end of Document for details)*

- invalidKey: PIN not valid and number of PIN checks attempts not exceeded,
- exceededNumberOfAttempts: PIN not valid and number of PIN checks attempts exceeded,
- generalReject: Correct PIN but mutual authentication with workshop card failed.

#### 5.2.2. Message format — SecurityAccess — requestSeed

The message formats for the SecurityAccess ‘requestSeed’ primitives are detailed in the following tables:

TABLE 18

#### SecurityAccess request — requestSeed message

Byte #	Parameter Name	Hex value	Mnemonic
#1	Format byte — physical addressing	80	FMT
#2	Target address byte	EE	TGT
#3	Source address byte	tt	SRC
#4	Additional length byte	02	LEN
#5	SecurityAccess request service Id	27	SA
#6	accessType — requestSeed	7D	AT_RSD
#7	Checksum	00-FF	CS

TABLE 19

#### SecurityAccess — requestSeed positive response message

Byte #	Parameter Name	Hex value	Mnemonic
#1	Format byte — physical addressing	80	FMT
#2	Target address byte	tt	TGT
#3	Source address byte	EE	SRC
#4	Additional length byte	04	LEN
#5	SecurityAccess positive response service Id	67	SAPR
#6	accessType — requestSeed	7D	AT_RSD
#7	Seed High	00-FF	SEEDH
#8	Seed Low	00-FF	SEEDL
#9	Checksum	00-FF	CS

*Changes to legislation: There are currently no known outstanding effects for the Council Regulation (EEC) No 3821/85. (See end of Document for details)*

TABLE 20

## SecurityAccess negative response message

Byte #	Parameter Name	Hex value	Mnemonic
#1	Format byte — physical addressing	80	FMT
#2	Target address byte	tt	TGT
#3	Source address byte	EE	SRC
#4	Additional length byte	03	LEN
#5	negativeResponse Service Id	7F	NR
#6	SecurityAccess request service Id	27	SA
#7	responseCode = (conditionsNotCorrectOrRequestSequenceErrorRC_CNC incorrectMessageLength) RC_IML	22	
#8	Checksum	00-FF	CS

## 5.2.3. Message format — SecurityAccess — sendKey

The message formats for the SecurityAccess ‘sendKey’ primitives are detailed in the following tables:

TABLE 21

## SecurityAccess request — sendKey message

Byte #	Parameter Name	Hex value	Mnemonic
#1	Format byte — physical addressing	80	FMT
#2	Target address byte	EE	TGT
#3	Source address byte	tt	SRC
#4	Additional length byte	m+2	LEN
#5	SecurityAccess Request Service Id	27	SA
#6	accessType — sendKey	7E	AT_SK
#7 to #m+6	Key #1 (High)	xx	KEY
	...	...	
	Key #m (low, m must be a minimum of 4, and a maximum of 8)	xx	

**Changes to legislation:** There are currently no known outstanding effects for the Council Regulation (EEC) No 3821/85. (See end of Document for details)

#m+7	Checksum	00-FF	CS
------	----------	-------	----

TABLE 22

SecurityAccess — sendKey positive response message

Byte #	Parameter Name	Hex value	Mnemonic
#1	Format byte — physical addressing	80	FMT
#2	Target address byte	tt	TGT
#3	Source address byte	EE	SRC
#4	Additional length byte	02	LEN
#5	SecurityAccess positive response service Id	67	SAPR
#6	accessType — sendKey	7E	AT_SK
#7	Checksum	00-FF	CS

TABLE 23

SecurityAccess negative response message

Byte #	Parameter Name	Hex value	Mnemonic
#1	Format byte — physical addressing	80	FMT
#2	Target address byte	tt	TGT
#3	Source address byte	EE	SRC
#4	Additional length byte	03	LEN
#5	NegativeResponse Service Id	7F	NR
#6	SecurityAccess request service Id	27	SA
#7	ResponseCode = (generalReject subFunctionNotSupported)	10 12	RC_GR RC_SFNS
	incorrectMessageLength	13	RC_IML
	conditionsNotCorrectOrRequestSequenceError	22	RC_CNC
	invalidKey	35	RC_IK
	exceededNumberOfAttempts	36	RC_ENA
	requestCorrectlyReceived (ResponsePending)	78	RC_RCR_RP

*Changes to legislation: There are currently no known outstanding effects for the Council Regulation (EEC) No 3821/85. (See end of Document for details)*

#8	Checksum	00-FF	CS
----	----------	-------	----

## 6. DATA TRANSMISSION SERVICES

The services available are detailed in the following table:

TABLE 24

Data transmission services

Service name	Description
ReadDataByIdentifier	The client requests the transmission of the current value of a record with access by recordDataIdentifier
WriteDataByIdentifier	The client requests to write a record accessed by recordDataIdentifier

### 6.1. ReadDataByIdentifier service

#### 6.1.1. Message description

The ReadDataByIdentifier service is used by the client to request data record values from a server. The data are identified by a recordDataIdentifier. It is the VU manufacturer's responsibility that the server conditions are met when performing this service.

#### 6.1.2. Message format

The message formats for the ReadDataByIdentifier primitives are detailed in the following tables:

TABLE 25

ReadDataByIdentifier request message

Byte #	Parameter Name	Hex value	Mnemonic
#1	Format byte — physical addressing	80	FMT
#2	Target address byte	EE	TGT
#3	Source address byte	tt	SRC
#4	Additional length byte	03	LEN
#5	ReadDataByIdentifier Request Service Id	22	RDBI
#6 and #7	[ <sup>x1</sup> recordDataIdentifier = (a value from Table 8)]	xxxx	RDI_ ...
#8	Checksum	00-FF	CS

**Changes to legislation:** There are currently no known outstanding effects for the Council Regulation (EEC) No 3821/85. (See end of Document for details)

TABLE 26

## ReadDataByIdentifier positive response message

Byte #	Parameter Name	Hex value	Mnemonic
#1	Format byte — physical addressing	80	FMT
#2	Target address byte	tt	TGT
#3	Source address byte	EE	SRC
#4	Additional length byte	m+3	LEN
#5	ReadDataByIdentifier Positive Response Service Id	62	RDBIPR
#6 and #7	recordDataIdentifier = (the same value as bytes #6 and #7 Table 25)	xxxx	RDI_ ...
#8 to #m+7	dataRecord() = (data#1 : data#m)	xx : xx	DREC_DATA1 : DREC_DATAm
#m+8	Checksum	00-FF	CS

TABLE 27

## ReadDataByIdentifier negative response message

Byte #	Parameter Name	Hex value	Mnemonic
#1	Format byte — physical addressing	80	FMT
#2	Target address byte	tt	TGT
#3	Source address byte	EE	SRC
#4	Additional length byte	03	LEN
#5	NegativeResponse Service Id	7F	NR
#6	ReadDataByIdentifier Request Service Id	22	RDBI
#7	ResponseCode = (requestOutOfRange incorrectMessageLength conditionsNotCorrect)	31 13	RC_ROOR RC_IML
		22	RC_CNC
#8	Checksum	00-FF	CS

**Changes to legislation:** There are currently no known outstanding effects for the Council Regulation (EEC) No 3821/85. (See end of Document for details)

### 6.1.3. Parameter definition

The parameter recordDataIdentifier (RDI\_) in the ReadDataByIdentifier request message identifies a data record.

recordDataIdentifier values defined by this document are shown in the table below.

The recordDataIdentifier table consists of four columns and multiple lines.

- The first column (Hex) includes the ‘hex value’ assigned to the recordDataIdentifier specified in the third column.
- The second column (Data element) specifies the data element of Appendix 1 on which the recordDataIdentifier is based (transcoding is sometimes necessary).
- The third column (Description) specifies the corresponding recordDataIdentifier name.
- The fourth column (Mnemonic) specifies the mnemonic of this recordDataIdentifier.

TABLE 28

Definition of recordDataIdentifier values

Hex	Data element	recordDataIdentifier Name(see format in Section 8.2)	Mnemonic
F90B	<i>CurrentDateTime</i>	TimeDate	RDI_TD
F912	<i>HighResOdometer</i>	HighResolutionTotalVehicleDistance	RDI_HRTVD
F918	<i>K-ConstantOfRecordingEquipment</i>	Kfactor	RDI_KF
F91C	<i>L-TyreCircumference</i>	LfactorTyreCircumference	RDI_LF
F91D	<i>W-VehicleCharacteristicConstant</i>	WvehicleCharacteristicConstant	RDI_WVCF
F921	<i>TyreSize</i>	TyreSize	RDI_TS
F922	<i>nextCalibrationDate</i>	NextCalibrationDate	RDI_NCD
F92C	<i>SpeedAuthorised</i>	SpeedAuthorised	RDI_SA
F97D	<i>vehicleRegistrationNumber</i>	RegisteringMemberState	RDI_RMS
F97E	<i>VehicleRegistrationNumber</i>	VehicleRegistrationNumber	RDI_VRN
F190	<i>VehicleIdentificationNumber</i>	MDr	RDI_VIN

The parameter dataRecord (DREC\_) is used by the ReadDataByIdentifier positive response message to provide the data record value identified by the recordDataIdentifier to the client (tester). Data formats are specified in Section 8. Additional user optional dataRecords including VU specific input, internal and output data may be implemented, but are not defined in this document.

## 6.2. WriteDataByIdentifier service

### 6.2.1. Message description



*Changes to legislation: There are currently no known outstanding effects for the Council Regulation (EEC) No 3821/85. (See end of Document for details)*

The WriteDataByIdentifier service is used by the client to write data record values to a server. The data are identified by a recordDataIdentifier. It is the VU manufacturer's responsibility that the server conditions are met when performing this service. To update the parameters listed in Table 28 the VU must be in CALIBRATION mode.

### 6.2.2. Message format

The message formats for the WriteDataByIdentifier primitives are detailed in the following tables:

TABLE 29

#### WriteDataByIdentifier request message

Byte #	Parameter Name	Hex value	Mnemonic
#1	Format byte — physical addressing	80	FMT
#2	Target address byte	EE	TGT
#3	Source address byte	tt	SRC
#4	Additional length byte	m+3	LEN
#5	WriteDataByIdentifier request service Id	2E	WDBI
#6 and #7	recordDataIdentifier = (a value from Table 28)	xxxx	RDI_ ...
#8 to #m+7	dataRecord() = (data#1 : data#m)	xx : xx	DREC_DATA1 : DREC_DATAm
#m+8	Checksum	00-FF	CS

TABLE 30

#### WriteDataByIdentifier positive response message

Byte #	Parameter Name	Hex value	Mnemonic
#1	Format byte — physical addressing	80	FMT
#2	Target address byte	tt	TGT
#3	Source address byte	EE	SRC
#4	Additional length byte	03	LEN
#5	WriteDataByIdentifier positive response service Id	6E	WDBIPR
#6 and #7	recordDataIdentifier = (the same value as	xxxx	RDI_ ...

*Changes to legislation: There are currently no known outstanding effects for the Council Regulation (EEC) No 3821/85. (See end of Document for details)*

	bytes #6 and #7 Table 29)		
#8	Checksum	00-FF	CS

TABLE 31

WriteDataByIdentifier negative response message

Byte #	Parameter Name	Hex value	Mnemonic
#1	Format byte — physical addressing	80	FMT
#2	Target address byte	tt	TGT
#3	Source address byte	EE	SRC
#4	Additional length byte	03	LEN
#5	NegativeResponse Service Id	7F	NR
#6	WriteDataByIdentifier request service Id	2E	WDBI
#7	ResponseCode = (requestOutOfRange incorrectMessageLength conditionsNotCorrect)	31 13 22	RC_ROOR RC_IML RC_CNC
#8	Checksum	00-FF	CS

### 6.2.3. Parameter definition

The parameter recordDataIdentifier (RDI\_) is defined in Table 28.

The parameter dataRecord (DREC\_) is used by the WriteDataByIdentifier request message to provide the data record values identified by the recordDataIdentifier to the server (VU). Data formats are specified in Section 8.

## 7. CONTROL OF TEST PULSES — INPUT/OUTPUT CONTROL FUNCTIONAL UNIT

The services available are detailed in the following table:

TABLE 32

Input/Output control functional unit

Service name	Description
InputOutputControlByIdentifier	The client requests the control of an input/output specific to the server

### 7.1. Message description

#### 7.1.1. Message description

---

**Changes to legislation:** There are currently no known outstanding effects for the Council Regulation (EEC) No 3821/85. (See end of Document for details)

---

There is a connection via the front connector which allows test pulses to be controlled or monitored using a suitable tester.

This calibration I/O signal line can be configured by K-line command using the InputOutputControlByIdentifier service to select the required input or output function for the line. The available states of the line are:

- disabled,
- speedSignalInput, where the calibration I/O signal line is used to input a speed signal (test signal) replacing the motion sensor speed signal,
- realTimeSpeedSignalOutputSensor, where the calibration I/O signal line is used to output the speed signal of the motion sensor,
- RTCOutput, where the calibration I/O signal line is used to output the UTC clock signal.

The vehicle unit must have entered an adjustment session and must be in CALIBRATION mode to configure the state of the line. On exit of the adjustment session or of the CALIBRATION mode the vehicle unit must ensure the calibration I/O signal line is returned to the ‘disabled’ (default) state.

If speed pulses are received at the real time speed signal input line of the VU while the calibration I/O signal line is set to input then the calibration I/O signal line shall be set to output or returned to the disabled state.

The sequence shall be:

- establish communications by StartCommunication Service
- enter an adjustment session by StartDiagnosticSession Service and be in CALIBRATION mode of operation (the order of these two operations is not important).
- change the state of the output by InputOutputControlByIdentifier Service.

#### 7.1.2. Message format

The message formats for the InputOutputControlByIdentifier primitives are detailed in the following tables:

TABLE 33

#### InputOutputControlByIdentifier request message

Byte #	Parameter name	Hex value	Mnemonic
#1	Format byte — physical addressing	80	FMT
#2	Target address byte	EE	TGT
#3	Source address byte	tt	SRC
#4	Additional length byte	xx	LEN
#5	InputOutputControlByIdentifier request Sid	Identifier	IOCBI

Note: The controlState parameter is present only in some cases (see 7.1.3).

---

*Changes to legislation: There are currently no known outstanding effects for the Council Regulation (EEC) No 3821/85. (See end of Document for details)*

#6 and #7	InputOutputIdentifier = (CalibrationInputOutput)	F960	IOI_CIO
#8 or #8 to #9	ControlOptionRecord = (inputOutputControlParameter — one value from Table 36	xx	COR_ ... IOCP_ ...
	controlState — one value from Table 38 (see note below))	xx	CS_ ...
#9 or #10	Checksum	00-FF	CS

Note: The controlState parameter is present only in some cases (see 7.1.3).

TABLE 34

## InputOutputControlByIdentifier positive response message

Byte #	Parameter Name	Hex value	Mnemonic
#1	Format byte — physical addressing	80	FMT
#2	Target address byte	tt	TGT
#3	Source address byte	EE	SRC
#4	Additional length byte	xx	LEN
#5	inputOutputControlByIdentifier positive response SID	0E	IOCBIPR
#6 and #7	inputOutputIdentifier = (CalibrationInputOutput)	F960	IOI_CIO
#8 or #8 to #9	controlStatusRecord = (inputOutputControlParameter (same value as byte #8 Table 33)	xx	CSR_ IOCP_ ...
	controlState (same value as byte #9 Table 33)) (if applicable)	xx	CS_ ...
#9 or #10	Checksum	00-FF	CS

TABLE 35

## InputOutputControlByIdentifier negative response message

Byte #	Parameter Name	Hex value	Mnemonic
--------	----------------	-----------	----------

**Changes to legislation:** There are currently no known outstanding effects for the Council Regulation (EEC) No 3821/85. (See end of Document for details)

#1	Format byte — physical addressing	80	FMT
#2	Target address byte	tt	TGT
#3	Source address byte	EE	SRC
#4	Additional length byte	03	LEN
#5	negativeResponse Service Id	7F	NR
#6	inputOutputControlByteIdentifier request SId		IOCBI
#7	responseCode = ( incorrectMessageLength	13	RC_IML
	conditionsNotCorrect	22	RC_CNC
	requestOutOfRange	31	RC_ROOR
	deviceControlLimitsExceeded	7A	RC_DCLE
#8	Checksum	00-FF	CS

### 7.1.3. Parameter definition

The parameter inputOutputControlParameter (IOCP\_) is defined in the following table:

TABLE 36

Definition of inputOutputControlParameter values

Hex	Description	Mnemonic
00	ReturnControlToECU This value shall indicate to the server (VU) that the tester does no longer have control about the calibration I/O signal line.	RCTECU
01	ResetToDefault This value shall indicate to the server (VU) that it is requested to reset the calibration I/O signal line to its default state.	RTD
03	ShortTermAdjustment This value shall indicate to the server (VU) that it is requested to adjust the calibration I/O signal line to the value included in the controlState parameter.	STA

*Changes to legislation: There are currently no known outstanding effects for the Council Regulation (EEC) No 3821/85. (See end of Document for details)*

The parameter controlState is present only when the inputOutputControlParameter is set to ShortTermAdjustment and is defined in the following table:

TABLE 37

Definition of controlState values

Mode	Hex value	Description
Disable	00	I/O line is disabled (default state)
Enable	01	Enable calibration I/O line as speedSignalInput
Enable	02	Enable calibration I/O line as realTimeSpeedSignalOutputSensor
Enable	03	Enable calibration I/O line as RTCOutput

## 8. DATARECORDS FORMATS

This section details:

- general rules that shall be applied to ranges of parameters transmitted by the vehicle unit to the tester,
- formats that shall be used for data transferred via the Data Transmission Services described in Section 6.

All parameters identified shall be supported by the VU.

Data transmitted by the VU to the tester in response to a request message shall be of the measured type (i.e. current value of the requested parameter as measured or observed by the VU).

### 8.1. Transmitted parameter ranges

Table 38 defines the ranges used to determine the validity of a transmitted parameter.

The values in the range ‘error indicator’ provide a means for the vehicle unit to immediately indicate that valid parametric data is not currently available due to some type of error in the recording equipment.

The values in the range ‘not available’ provide a means for the vehicle unit to transmit a message which contains a parameter that is not available or not supported in that module. The values in the range ‘not requested’ provide a means for a device to transmit a command message and identify those parameters where no response is expected from the receiving device.

If a component failure prevents the transmission of valid data for a parameter, the error indicator as described in Table 38 should be used in place of that parameter's data. However, if the measured or calculated data has yielded a value that is valid yet exceeds the defined parameter range, the error indicator should not be used. The data should be transmitted using the appropriate minimum or maximum parameter value.

TABLE 38

dataRecords ranges

**Changes to legislation:** There are currently no known outstanding effects for the Council Regulation (EEC) No 3821/85. (See end of Document for details)

Range Name	1 byte(Hex value)	2 bytes(Hex value)	4 bytes(Hex value)	ASCII
Valid signal	00 to FA	0000 to FAFF	00000000 to FAFFFFFF	1 to 254
Parameter specific indicator	FB	FB00 to FBFF	FB000000 to FBFFFFFF	none
Reserved range for future indicator bits	FC to FD	FC00 to FDFF	FC000000 to FDFFFFFF	none
Error indicator	FE	FE00 to FEFF	FE000000 to FEFFFFFF	0
Not available or not requested	FF	FF00 to FFFF	FF000000 to FFFFFFFF	FF

For parameters coded in ASCII, the ASCII character ‘\*’ is reserved as a delimiter.

## 8.2. dataRecords formats

[<sup>X1</sup>Tables 39 to 42 below detail the formats that shall be used via the ReadDataByIdentifier and WriteDataByIdentifier Services.]

[<sup>X1</sup>Table 39 provides the length, resolution and operating range for each parameter identified by its recordDataIdentifier]

TABLE 39

### Format of dataRecords

Parameter Name	Data length (bytes)	Resolution	Operating range
TimeDate	8	See details in Table 40	
HighResolutionTotalVehicleDistance		5 m/bit gain, 0 m offset	0 to + 21 055 406 km
Kfactor	2	0,001 pulse/m/bit gain, offset 0	0 to 64,255 pulse/m
LfactorTyreCircumference		0,125 10 <sup>-3</sup> /bit gain, 0 offset	[ <sup>X1</sup> 0 to 8,031 m]
WvehicleCharacteristicFactor		0,001 pulse/m/bit gain, 0 offset	0 to 64,255 pulse/m
TyreSize	15	ASCII	ASCII
NextCalibrationDate	3	See details in Table 41	
SpeedAuthorised	2	1/256 km/h/bit gain, 0 offset	[ <sup>X1</sup> 0 to 250,996 km/h]
RegisteringMemberState	3	ASCII	ASCII
VehicleRegistrationNumber		[ <sup>X1</sup> See details in Table 42]	
VIN	17	ASCII	ASCII

*Changes to legislation: There are currently no known outstanding effects for the Council Regulation (EEC) No 3821/85. (See end of Document for details)*

Table 40 details the formats of the different bytes of the TimeDate parameter:

TABLE 40

Detailed format of TimeDate ([<sup>F22</sup>recordDataIdentifier value # F90B])

Byte	Parameter definition	Resolution	Operating range
1	Seconds	0,25 s/bit gain, 0 s offset	0 to 59,75 s
2	Minutes	1 min/bit gain, 0 min offset	0 to 59 min
3	Hours	1 h/bit gain, 0 h offset	0 to 23 h
4	Month	1 month/bit gain, 0 month offset	[ <sup>X1</sup> 1 to 12 month]
5	Day	0,25 day/bit gain, 0 day offset (see Note below Table 41)	0,25 to 31,75 day
6	Year	1 year/bit gain, +1985 year offset (see Note below Table 41)	1985 to 2235 year
7	Local Minute Offset	1 min/bit gain, - 125 min offset	[ <sup>F22</sup> -59 to +59 min]
8	Local Hour Offset	1 h/bit gain, [ <sup>X1</sup> - 125 h offset]	- 23 to + 23 h

Table 41 details the formats of the different bytes of the NextCalibrationDate parameter:

TABLE 41

Detailed format of NextCalibrationDate ([<sup>F22</sup>recordDataIdentifier value # F922])

Byte	Parameter definition	Resolution	Operating range
1	Month	1 month/bit gain, 0 month offset	1 to 12 month
2	Day	0,25 day/bit gain, 0 day offset (see Note below)	0,25 to 31,75 day
3	Year	1 Year/bit gain, +1985 year offset (see Note below)	1985 to 2235 year

Note concerning the use of the 'Day' parameter:

1. A value of 0 for the date is null. The values 1, 2, 3, and 4 are used to identify the first day of the month; 5, 6, 7, and 8 identify the second day of the month; etc.
2. This parameter does not influence or change the hours parameter above.

Note concerning the use of byte 'Year' parameter:

A value of 0 for the year identifies the year 1985; a value of 1 identifies 1986; etc.



---

**Changes to legislation:** There are currently no known outstanding effects for the Council Regulation (EEC) No 3821/85. (See end of Document for details)

---

Table 42 details the formats of the different bytes of the VehicleRegistrationNumber parameter:

TABLE 42

Detailed format of VehicleRegistrationNumber ([<sup>F22</sup>recordDataIdentifier value # F97E])

<b>Byte</b>	<b>Parameter definition</b>	<b>Resolution</b>	<b>Operating range</b>
1	Code Page (as defined in Appendix 1)	ASCII	01 to 0A
2 to 14	Vehicle Registration Number (as defined in Appendix 1)	ASCII	ASCII

---

*Changes to legislation: There are currently no known outstanding effects for the Council Regulation (EEC) No 3821/85. (See end of Document for details)*

---

## Appendix 9

### TYPE APPROVAL — LIST OF MINIMUM REQUIRED TESTS

#### 1. INTRODUCTION

##### 1.1. Type approval

The EEC type approval for a recording equipment (or component) or a tachograph card is based on:

- a security certification, performed by an ITSEC authority, against a security target fully compliant with Appendix 10 to this Annex,
- a functional certification performed by a Member State authority certifying that the item tested fulfils the requirements of this Annex in terms of functions performed, measurement accuracy and environmental characteristics,
- an interoperability certification performed by the competent body certifying that the recording equipment (or tachograph card) is fully interoperable with the necessary tachograph card (or recording equipment) models (see Chapter VIII of this Annex).

This Appendix specifies which tests, as a minimum, must be performed by a Member State authority during the functional tests, and which tests, as a minimum, must be performed by the competent body during the interoperability tests. Procedures to follow to carry out the tests or the type of tests are not specified further.

The security certification aspects are not covered by this Appendix. If some tests requested for type approval are performed during the security evaluation and certification process, then these tests do not need to be performed again. In this case, only the results of these security tests may be inspected. For information, the requirements expected to be tested (or closely related to tests expected to be performed) during the security certification, are marked with a ‘\*’ in this Appendix.

This Appendix considers separately the type approval of the motion sensor and of the vehicle unit, as components of the recording equipment. Interoperability between every model of motion sensor and every model of vehicle unit is not required, therefore the type approval for a motion sensor can be granted only in combination with the type approval of a vehicle unit and vice versa.

##### 1.2. References

The following references are used in this Appendix:

IEC 68-2-1	Environmental testing — Part 2: Tests — Tests A: Cold. 1990 + Amendment 2: 1994.
IEC 68-2-2	Environmental testing — Part 2: Tests — Tests B: Dry heat. 1974 + Amendment 2: 1994.
IEC 68-2-6	Basic environmental testing procedures — Test methods — Test Fc and guidance: Vibration (sinusoidal). 6th edition: 1985.
IEC 68-2-14	Basic environmental testing procedures — Test methods — Test N: Change of temperature. Modification 1: 1986.
IEC 68-2-27	Basic environmental testing procedures — Test methods — Test Ea and guidance: Shock. Edition 3: 1987.
IEC 68-2-30	Basic environmental testing procedures — Test methods — Test Db and guidance: Damp heat, cyclic (12 + 12 — hour cycle). Modification 1: 1985.

**Changes to legislation:** There are currently no known outstanding effects for the Council Regulation (EEC) No 3821/85. (See end of Document for details)

IEC 68-2-35	Basic environmental testing procedure — Test methods — Test Fda: Random vibration wide band — Reproducibility High. Modification 1: 1983.
IEC 529	Degrees of protection provided by enclosures (IP code). Edition 2: 1989.
IEC 61000-4-2	Electromagnetic Compatibility (EMC) — Testing and measurement techniques — Electrostatic discharge immunity test: 1995/Amendment 1: 1998.
ISO 7637-1	Road vehicles — Electrical disturbance by conduction and coupling — Part 1: Passenger cars and light commercial vehicles with nominal 12 V supply voltage — Electrical transient conduction along supply lines only. Edition 2: 1990.
[ <sup>X1</sup> ISO 7637-2	Road vehicles — Electrical disturbance by conduction and coupling — Part 2: Commercial vehicles with nominal 24 V supply voltage — Electrical transient conduction along supply lines only. First edition: 1990.]
ISO 7637-3	Road vehicles — Electrical disturbance by conduction and coupling — Part 3: Vehicles with 12 V or 24 V supply voltage — Electrical transient transmission by capacitive and inductive coupling via lines other than supply lines. First Edition: 1995 + Cor 1: 1995.
ISO/IEC 7816-1	Identification cards — Integrated circuit(s) cards with contacts — Part 1: Physical characteristics. First edition: 1998.
ISO/IEC 7816-2	Information technology — Identification cards — Integrated circuit(s) cards with contacts — Part 2: Dimensions and location of the contacts. First edition: 1999.
ISO/IEC 7816-3	Information technology — Identification cards — Integrated circuit(s) cards with contacts — Part 3: Electronic signals and transmission protocol. Edition 2: 1997.
ISO/IEC 10373	Identification cards — Test methods. First edition: 1993.
[ <sup>F18</sup> ISO 16844-3	2004, Cor 1:2006 Road vehicles – Tachograph systems – Part 3: Motion sensor interface (with vehicle units).]

## 2. VEHICLE UNIT FUNCTIONAL TESTS

No	Test	Description	Related requirements
1.	<b>Administrative examination</b>		
1.1.	Documentation	Correctness of documentation	
1.2.	Manufacturer test results	Results of manufacturer test performed during integration. Paper demonstrations	070, 071, 073
2.	<b>Visual inspection</b>		
2.1.	Compliance with documentation		
2.2.	Identification/markings		168, 169
2.3.	Materials		163 to 167
2.4	Sealing		251

*Changes to legislation: There are currently no known outstanding effects for the Council Regulation (EEC) No 3821/85. (See end of Document for details)*

2.5.	External interfaces	
3.	<b>Functional tests</b>	
3.1.	Functions provided	002, 004, 244
3.2.	Modes of operation	006*, 007*, 008*, 009*, 106, 107
3.3.	Functions and data access rights	010*, 011*, 240, 246, 247
3.4.	Monitoring cards insertion and withdrawal	013, 014, 015*, 016*, 106
3.5.	Speed and distance measurement	017 to 026
3.6.	Time measurement (test performed at 20 °C)	027 to 032
3.7.	Monitoring driver activities	033 to 043, 106
3.8.	Monitoring driving status	044, 045, 106
3.9.	Manual entries	046 to 050b
3.10.	Company locks management	051 to 055
3.11.	Monitoring control activities	056, 057
3.12.	Detection of events and/or faults	059 to 069, 106
3.13.	Equipment identification data	075*, 076*, 079
3.14.	Driver card insertion and withdrawal data	081* to 083*
3.15.	Driver activity data	084* to 086*
3.16.	Places data	087* to 089*
3.17.	Odometer data	090* to 092*
3.18.	Detailed speed data	093*
3.19.	Events data	094*, 095
3.20.	Faults data	096*
3.21.	Calibration data	097*, 098*
3.22.	Time adjustment data	100*, 101*
3.23.	Control activity data	102*, 103*
3.24.	Company locks data	104*
3.25.	Download activity data	105*
3.26.	Specific conditions data	105a*, 105b*
3.27.	Recording and storing on tachographs cards	108, 109*, 109a*, 110*, 111, 112
3.28.	Displaying	072, 106, 113 to 128, PIC_001, DIS_001

**Changes to legislation:** There are currently no known outstanding effects for the Council Regulation (EEC) No 3821/85. (See end of Document for details)

3.29.	Printing	072, 106, 129 to 138, PIC_001, PRT_001 to PRT_012
3.30.	Warning	106, 139 to 148, PIC_001
3.31.	Data downloading to external media	072, 106, 149 to 151
3.32.	Output data to additional external devices	152, 153
3.33.	Calibration	154*, 155*, 156*, 245
3.34.	Time adjustment	157*, 158*
3.35.	Non-interference of additional functions	003, 269
[ <sup>F18</sup> 3.36.	Motion sensor interface	001a, 099]
[ <sup>F18</sup> 3.37.	Verify that the VU detects, records and stores the event(s) and/or fault(s) defined by the VU manufacturer when a paired motion sensor reacts to magnetic fields disturbing vehicle motion detection	161a]
4.	<b>Environmental tests</b>	
4.1.	Temperature	<p>Verify functionality through:</p> <ul style="list-style-type: none"> <li>— IEC 68-2-1, test Ad, with a test duration of 72 hours at the lower temperature (- 20 °C), 1 hour operating, 1 hour non operating,</li> <li>— IEC 68-2-2, test Bd, with a test duration of 72 hours at the higher temperature (+ 70 °C), 1 hour operating, 1 hour non operating</li> </ul> <p>Temperature cycles: verify that the vehicle unit can withstand</p>

**Changes to legislation:** There are currently no known outstanding effects for the Council Regulation (EEC) No 3821/85. (See end of Document for details)

		<p>rapid changes in the environment temperature through IEC 68-2-14 test Na, 20 cycles, each with temperature varying from the lower temperature (-20 °C) to the higher temperature (+ 70 °C) and a 2 hours stay at both the lower and the higher temperature</p> <p>A reduced set of tests (among those defined in section 3 of this table) can be carried out at the lower temperature, the higher temperature and during the temperature cycles</p>	
4.2.	Humidity	<p>Verify that the vehicle unit can withstand a cyclic damp (heat test) through IEC 68-2-30, test Db, six 24 hours cycles, each temperature varying from + 25 °C to + 55 °C and a relative humidity of 97 % at + 25 °C and equal to 93 % at + 55 °C</p>	160
4.3.	Vibration	<p>1. Sinusoidal vibrations:</p> <p>verify that the vehicle unit can withstand sinusoidal vibrations with the</p>	163

**Changes to legislation:** There are currently no known outstanding effects for the Council Regulation (EEC) No 3821/85. (See end of Document for details)

following characteristics:  
constant displacement between 5 and 11 Hz: 10 mm peak constant acceleration between 11 and 300 Hz: 5 g

This requirement is verified through IEC 68-2-6, test Fc, with a minimum test duration of 3 × 12 hours (12 hours per axis)

2. Random vibrations:  
verify that the vehicle unit can withstand

---

**Changes to legislation:** There are currently no known outstanding effects for the Council Regulation (EEC) No 3821/85. (See end of Document for details)

---

random  
vibrations  
with  
the  
following  
characteristics:  
frequency  
5-150  
Hz,  
level  
0,02  
 $g^2/$   
Hz

This  
requirement  
is  
verified  
through  
IEC  
68-2-35,  
test  
Fda,  
with  
a  
minimum  
test  
duration  
of  
3  
×  
12  
hours  
(12  
hours  
per  
axis),  
1  
hour  
operating,  
1  
hour  
non  
operating

The two  
tests  
described  
above are  
performed  
on two  
different  
samples  
of the  
equipment



**Changes to legislation:** There are currently no known outstanding effects for the Council Regulation (EEC) No 3821/85. (See end of Document for details)

		type being tested	
4.4.	Protection against water and foreign bodies	Verify that the vehicle unit protection index according to IEC 529 is at least IP 40, when mounted in operating conditions in a vehicle	164, 165
4.5.	Over-voltage protection	Verify that the vehicle unit can withstand a power supply of: 24V versions: 34 V at + 40 °C 1 hour 12V versions: 17 V at + 40 °C 1 hour	161
4.6.	Reverse polarity protection	Verify that the vehicle unit can withstand an inversion of its power supply	161
4.7.	Short-circuit protection	Verify that input output signals are protected against short circuits to power supply and ground	161
5.	<b>EMC tests</b>		
5.1.	Radiated emissions and susceptibility	Compliance with Directive 95/54/EEC	162
5.2.	Electrostatic discharge	Compliance with IEC 61000-4-2, ± 2 kV (level 1)	162
5.3.	Conducted transient susceptibility on power supply	For 24V versions: compliance with ISO 7637-2: pulse 1a: V <sub>s</sub> = - 100 V, R <sub>i</sub> = 10 ohms pulse 2: V <sub>s</sub> = + 100	162

**Changes to legislation:** There are currently no known outstanding effects for the Council Regulation (EEC) No 3821/85. (See end of Document for details)

V, Ri = 10  
ohms  
pulse 3a:  
Vs = - 100  
V, Ri = 50  
ohms  
pulse 3b:  
Vs = + 100  
V, Ri = 50  
ohms  
pulse 4: Vs  
= - 16 V Va  
= - 12 V,  
t6=100 ms  
pulse 5: Vs  
= + 120 V,  
Ri = 2,2  
ohms, td =  
250 ms

For 12V versions:  
compliance with ISO  
7637-1:

pulse 1:  
Vs = - 100  
V, Ri = 10  
ohms  
pulse 2:  
Vs = + 100  
V, Ri = 10  
ohms  
pulse 3a:  
Vs = - 100  
V, Ri = 50  
ohms  
pulse 3b:  
Vs = + 100  
V, Ri = 50  
ohms  
pulse 4: Vs  
= - 6 V, Va  
= - 5 V, t6 =  
15 ms  
pulse 5: Vs  
= + 65 V, Ri  
= 3 ohms, td  
= 100 ms

Pulse 5 shall be tested  
only for vehicle  
units designed to be  
installed in vehicles  
for which no external  
common protection

**Changes to legislation:** There are currently no known outstanding effects for the Council Regulation (EEC) No 3821/85. (See end of Document for details)

		against load dump is implemented	
--	--	----------------------------------	--

### 3. MOTION SENSOR FUNCTIONAL TESTS

No	Test	Description	Related requirements
1.	<b>Administrative examination</b>		
1.1.	Documentation	Correctness of documentation	
2.	<b>Visual inspection</b>		
2.1.	Compliance with documentation		
2.2.	Identification/markings		169, 170
2.3.	Materials		163 to 167
2.4.	Sealing		251
3.	<b>Functional tests</b>		
3.1.	Sensor identification data		077*
3.2.	Motion sensor — vehicle unit pairing		099*, 155
3.3.	Motion detection		
	Motion measurement accuracy		022 to 026
[ <sup>F18</sup> 3.4.	Vehicle unit interface		001a]
[ <sup>F18</sup> 3.5.	Check that the motion sensor is immune to magnetic field. Alternatively, verify that the motion sensor reacts to magnetic fields disturbing vehicle motion detection so that a paired VU can detect, record and store sensor faults		161a]
4.	<b>Environmental tests</b>		
4.1.	Operating temperature	Verify functionality (as defined in test No 3.3) in temperature range [- 40 °C; + 135 °C] through: <ul style="list-style-type: none"> <li>— IEC 68-2-1 test Ad, with a test duration of 96 hours at the lowest temperature <math>T_{\min}</math></li> <li>— IEC 68-2-2 test Bd,</li> </ul>	159

**Changes to legislation:** There are currently no known outstanding effects for the Council Regulation (EEC) No 3821/85. (See end of Document for details)

		with a test duration of 96 hours at the highest temperature $T_{0_{max}}$	
4.2.	Temperature cycles	Verify functionality (as defined in test No 3.3) through IEC 68-2-14 test Na, 20 cycles, each with temperature varying from the lower temperature (-40 °C) to the higher temperature (+135 °C) and a 2 hours stay at both the lower and the higher temperature A reduced set of tests (among those defined in test 3.3) can be carried out at the lower temperature, the higher temperature and during the temperature cycles	159
4.3.	Humidity cycles	Verify functionality (as defined in test No 3.3) through IEC 68-2-30, test Db, six 24 hours cycles, each temperature varying from + 25 °C to + 55 °C and a relative humidity of 97 % at + 25 °C and equal to 93 % at + 55 °C	160
4.4.	Vibration	Verify functionality (as defined in test No 3.3) through IEC 68-2-6, test Fc, with a test duration of 100 frequency cycles: constant displacement between 10 and 57 Hz: 1,5 mm peak constant	163

**Changes to legislation:** There are currently no known outstanding effects for the Council Regulation (EEC) No 3821/85. (See end of Document for details)

		acceleration between 57 and 500 Hz: 20 g	
4.5.	Mechanical shock	Verify functionality (as defined in test No 3.3) through IEC 68-2-27, test Ea, 3 shocks in both directions of the 3 perpendicular axes	163
4.6.	Protection against water and foreign bodies	Verify that the motion sensor protection index according to IEC 529 is at least IP 64, when mounted in operating conditions in a vehicle	165
4.7.	Reverse polarity protection	Verify that the motion sensor can withstand an inversion of its power supply	161
4.8.	Short circuit protection	Verify that input output signals are protected against short circuits to power supply and ground	161
5.	<b>EMC</b>		
5.1.	Radiated emissions and susceptibility	Verify compliance with Directive 95/54/EEC	162
5.2.	Electrostatic discharge	Compliance with IEC 61000-4-2, $\pm 2$ kV (level 1)	162
5.3.	Conducted transient susceptibility on data lines)	Compliance with ISO 7637-3 (level III)	162

#### 4. TACHOGRAPH CARDS FUNCTIONAL TESTS

No	Test	Description	Related requirements
1.	<b>Administrative examination</b>		
1.1.	Documentation	Correctness of documentation	
2.	<b>Visual inspection</b>		

*Changes to legislation: There are currently no known outstanding effects for the Council Regulation (EEC) No 3821/85. (See end of Document for details)*

2.1.		Make sure that all features for protection and visible data are correctly printed on the card and compliant	171 to 181
3.	<b>Physical tests</b>		
3.1.		Check dimension of the card and location of the contacts	184 ISO/IEC 7816-1 ISO/IEC 7816-2
4.	<b>Protocol tests</b>		
4.1.	ATR	Check that the ATR is compliant	ISO/IEC 7816-3 TCS 304, 307, 308
4.2.	T=0	Check that T=0 protocol is compliant	ISO/IEC 7816-3 TCS 302, 303, 305
4.3.	PTS	Check that the PTS command is compliant by setting T=1 from T=0	ISO/IEC 7816-3 TCS 309 to 311
4.4.	T=1	Check that T=1 protocol is compliant	ISO/IEC 7816-3 TCS 303, / 306
5.	<b>Card structure</b>		
5.1.		Test that the file structure of the card is compliant by checking the presence of the mandatory files in the card and their access conditions	TCS 312 TCS 400*, 401, 402, 403*, 404, 405*, 406, 407, 408*, 409, 410*, 411, 412, 413*, 414, 415*, 416, 417, 418*, 419
6.	<b>Functional tests</b>		
6.1.	Normal processing	Test at least once each allowed usage of each command (ex: test the UPDATE BINARY command with CLA = '00', CLA = '0C' and with different P1, P2 and Lc parameters) Check that the operations have actually been performed in the card (ex: by reading the file the command has been performed on)	TCS 313 to TCS 379

**Changes to legislation:** There are currently no known outstanding effects for the Council Regulation (EEC) No 3821/85. (See end of Document for details)

6.2.	Error messages	Test at least once each error message (as specified in Appendix 2) for each command Test at least once every generic error (except '6400' integrity errors checked during security certification)	
7.	<b>Environmental tests</b>		
7.1.		Make sure that the cards work within the limit conditions defined in accordance with ISO/IEC 10373	185 to 188 ISO/IEC 7816-1

## 5. INTEROPERABILITY TESTS

No	Test	Description
1.	Mutual authentication	Check that the mutual authentication between the vehicle unit and the tachograph card runs normally
2.	Write/read tests	Execute a typical activity scenario on the vehicle unit. The scenario shall be adapted to the type of card being tested and involve writings in as many EFs as possible in the card Verify through a card downloading that all corresponding recordings have been properly made Verify through a card daily printout that all corresponding recordings can be properly read

---

*Changes to legislation: There are currently no known outstanding effects for the Council Regulation (EEC) No 3821/85. (See end of Document for details)*

---

## Appendix 10

### GENERIC SECURITY TARGETS

This appendix specifies the minimum required content of motion sensor, vehicle unit and tachograph card security targets.

In order to form the security targets against which they may seek security certification, manufacturers shall refine and complete the documents as necessary, without amending nor deleting existing threats, objectives, procedural means and security enforcing functions specifications.

#### MOTION SENSOR GENERIC SECURITY TARGET

##### 1. Introduction

This document contains a description of the motion sensor, of the threats it must be able to counteract and of the security objectives it must achieve. It specifies the required security enforcing functions. It states the claimed minimum strength of security mechanisms and the required level of assurance for the development and the evaluation.

Requirements referred to in the document, are those of the body of Annex I B. For clarity of reading, duplication sometimes arises between Annex I B body requirements and security target requirements. In case of ambiguity between a security target requirement and the Annex I B body requirement referred by this security target requirement, the Annex I B body requirement shall prevail.

Annex I B body requirements not referred by security targets are not the subject of security enforcing functions.

Unique labels have been assigned to threats, objectives, procedural means and SEF specifications for the purpose of traceability to development and evaluation documentation.

##### 2. Abbreviations, definitions and references

###### 2.1. Abbreviations

ROM	Read only Memory
SEF	Security enforcing function
TBD	To be defined
TOE	Target of evaluation
VU	Vehicle unit.

###### 2.2. Definitions

Digital Tachograph	Recording equipment
Entity	A device connected to the motion sensor
Motion data	The data exchanged with the VU, representative of speed and distance travelled
Physically separated parts	Physical components of the motion sensor that are distributed in the vehicle as opposed to physical components gathered into the motion sensor casing
Security data	The specific data needed to support security enforcing functions (e.g. crypto keys)
System	Equipment, people or organisations, involved in any way with the recording equipment



---

**Changes to legislation:** There are currently no known outstanding effects for the Council Regulation (EEC) No 3821/85. (See end of Document for details)

---

User	A human user of the motion sensor (when not used in the expression 'user data')
User data	Any data, other than motion or security data, recorded or stored by the motion sensor.

### 2.3. References

ITSEC ITSEC Information Technology Security Evaluation Criteria 1991.

## 3. Product rationale

### 3.1. Motion sensor description and method of use

The motion sensor is intended to be installed in road transport vehicles. Its purpose is to provide a VU with secured motion data representative of vehicle's speed and distance travelled.

The motion sensor is mechanically interfaced to a moving part of the vehicle, which movement can be representative of vehicle's speed or distance travelled. It may be located in the vehicle's gear box or in any other part of the vehicle.

In its operational mode, the motion sensor is connected to a VU.

It may also be connected to specific equipment for management purposes (TBD by manufacturer).

The typical motion sensor is described in the following figure:

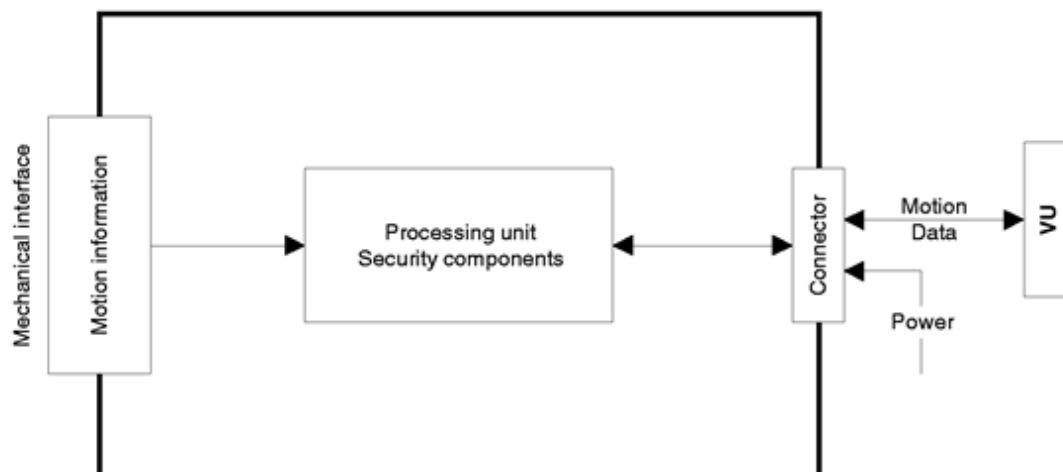

### 3.2. Motion sensor life cycle

The typical life cycle of the motion sensor is described in the following figure:

*Changes to legislation:* There are currently no known outstanding effects for the Council Regulation (EEC) No 3821/85. (See end of Document for details)

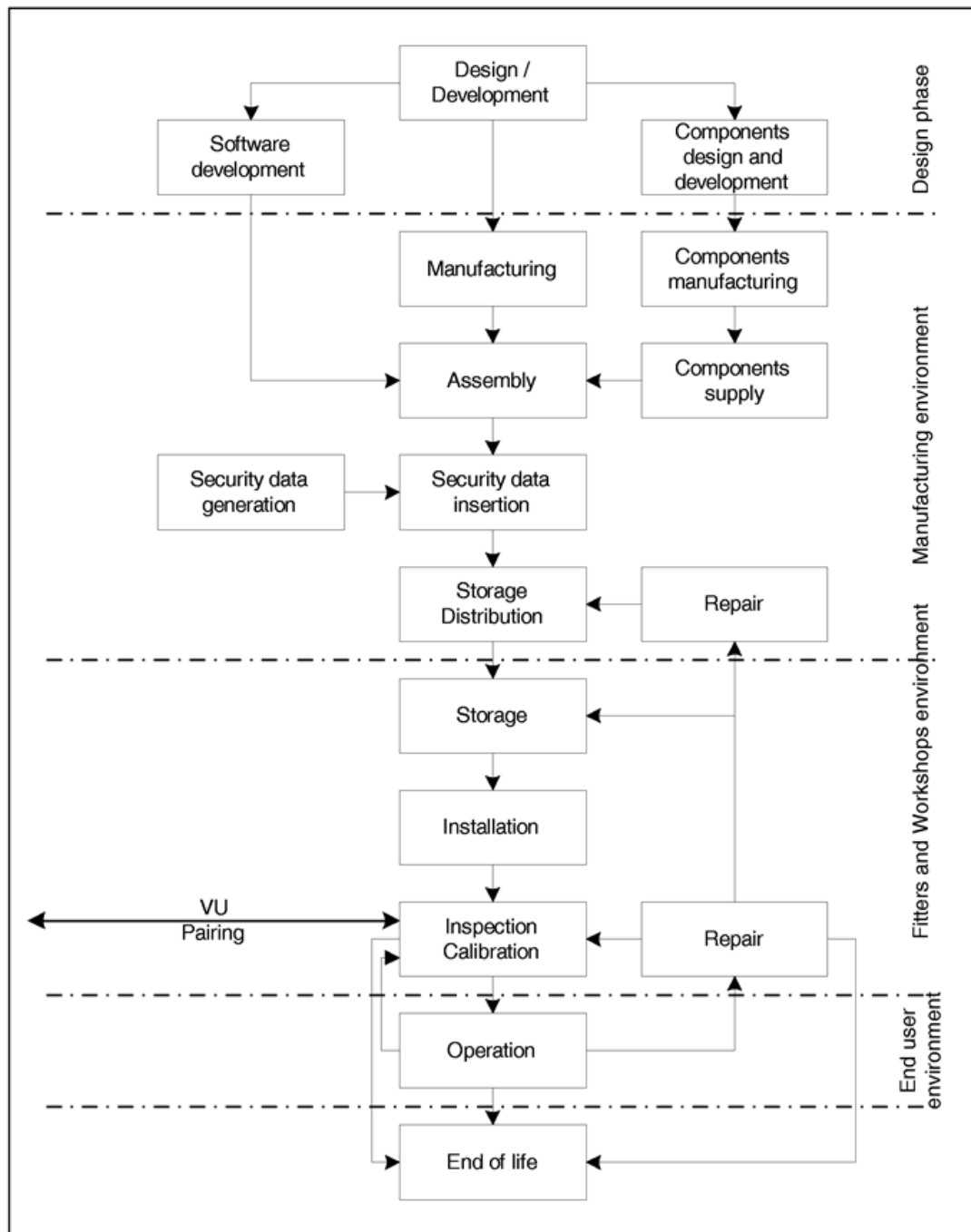

### 3.3. Threats

This paragraph describes the threats the motion sensor may face.

#### 3.3.1. Threats to access control policies

T.Access Users could try to access functions not allowed to them.

#### 3.3.2. Design related threats

---

**Changes to legislation:** There are currently no known outstanding effects for the Council Regulation (EEC) No 3821/85. (See end of Document for details)

---

T.Faults	Faults in hardware, software, communication procedures could place the motion sensor in unforeseen conditions compromising its security
T.Tests	The use of non invalidated test modes or of existing back doors could compromise the motion sensor security
T.Design	Users could try to gain illicit knowledge of design either from manufacturer's material (through theft, bribery, ...) or from reverse engineering.

### 3.3.3. Operation oriented threats

T.Environment	Users could compromise the motion sensor security through environmental attacks (thermal, electromagnetic, optical, chemical, mechanical, ...)
T.Hardware	Users could try to modify motion sensor hardware
T.Mechanical_Origin	Users could try to manipulate the motion sensor input (e.g. unscrewing from gearbox, ...)
T.Motion_Data	Users could try to modify the vehicle's motion data (addition, modification, deletion, replay of signal)
T.Power_Supply	Users could try to defeat the motion sensor security objectives by modifying (cutting, reducing, increasing) its power supply
T.Security_Data	Users could try to gain illicit knowledge of security data during security data generation or transport or storage in the equipment
T.Software	Users could try to modify motion sensor software
T.Stored_Data	Users could try to modify stored data (security or user data).

### 3.4. Security objectives

The main security objective of the digital tachograph system is the following:

O.Main	The data to be checked by control authorities must be available and reflect fully and accurately the activities of controlled drivers and vehicles in terms of driving, work, availability and rest periods and in terms of vehicle speed
--------	---

Therefore the security objective of the motion sensor, contributing to the global security objective, is:

O.Sensor_Main	The data transmitted by the motion sensor must be available to the VU so as to allow the VU to determine fully and accurately the movement of the vehicle in terms of speed and distance travelled.
---------------	---

### 3.5. Information technology security objectives

The specific IT security objectives of the motion sensor contributing to its main security objective, are the following:

O.Access	The motion sensor must control connected entities' access to functions and data
O.Audit	The motion sensor must audit attempts to undermine its security and should trace them to associated entities
O.Authentication	The motion sensor must authenticate connected entities
O.Processing	The motion sensor must ensure that processing of input to derive motion data is accurate
O.Reliability	The motion sensor must provide a reliable service
O.Secured_Data_Exchange	The motion sensor must secure data exchanges with the VU.

### 3.6. Physical, personnel or procedural means

---

*Changes to legislation: There are currently no known outstanding effects for the Council Regulation (EEC) No 3821/85. (See end of Document for details)*

---

This paragraph describes physical, personnel or procedural requirements that contribute to the security of the motion sensor.

### 3.6.1. Equipment design

- M.Development Motion sensor developers must ensure that the assignment of responsibilities during development is done in a manner which maintains IT security
- M.Manufacturing Motion sensor manufacturers must ensure that the assignment of responsibilities during manufacturing is done in a manner which maintains IT security, and that during the manufacturing process the motion sensor is protected from physical attacks which might compromise IT security.

### 3.6.2. Equipment delivery

- M.Delivery Motion sensor manufacturers, vehicle manufacturers and fitters or workshops must ensure that handling of the motion sensor is done in a manner which maintains IT security.

### 3.6.3. Security data generation and delivery

- M.Sec\_Data\_Generation Security data generation algorithms must be accessible to authorised and trusted persons only
- M.Sec\_Data\_Transport Security data must be generated, transported, and inserted into the motion sensor, in such a way to preserve its appropriate confidentiality and integrity.

### 3.6.4. Recording equipment installation, calibration, and inspection

- M.Approved\_Workshops Installation, calibration and repair of recording equipment must be carried by trusted and approved fitters or workshops
- M.Mechanical\_Interface Means of detecting physical tampering with the mechanical interface must be provided (e.g. seals)
- M.Regular\_Inspections Recording equipment must be periodically inspected and calibrated.

### 3.6.5. Law enforcement control

- M.Controls Law enforcement controls must be performed regularly and randomly, and must include security audits.

### 3.6.6. Software upgrades

- M.Software\_Upgrade Software revisions must be granted security certification before they can be implemented in a motion sensor.

## 4. Security enforcing functions

### 4.1. Identification and authentication

The motion sensor shall be able to establish, for every interaction, the identity of any entity it is connected to.

The identity of a connected entity shall consist of:

- an entity group:
  - VU,
  - Management device,
  - Other,

---

**Changes to legislation:** There are currently no known outstanding effects for the Council Regulation (EEC) No 3821/85. (See end of Document for details)

---

— an entity ID (VU only).

The entity ID of a connected VU shall consist of the VU approval number and the VU serial number.

The motion sensor shall be able to authenticate any VU or management device it is connected to:

- at entity connection,
- at power supply recovery.

The motion sensor shall be able to periodically re-authenticate the VU it is connected to.

The motion sensor shall detect and prevent use of authentication data that has been copied and replayed.

After (TBD by manufacturer and not more than 20) consecutive unsuccessful authentication attempts have been detected, the SEF shall:

- generate an audit record of the event,
- warn the entity,
- continue to export motion data in a non secured mode.

#### 4.2. Access control

Access controls ensure that information is read from, created in, or modified into the TOE only by those authorised to do so.

##### 4.2.1. Access control policy

The motion sensor shall control access rights to function and data.

##### 4.2.2. Data access rights

The motion sensor shall ensure that motion sensor identification data can be written once only (requirement 078).

The motion sensor shall accept and/or store user data from authenticated entities only.

The motion sensor shall enforce appropriate read and write access rights to security data.

##### 4.2.3. File structure and access conditions

Application and data files structure and access conditions shall be created during the manufacturing process, and then locked from any future modification or deletion.

#### 4.3. Accountability

The motion sensor shall hold in its memory motion sensor identification data (requirement 077).

The motion sensor shall store in its memory installation data (requirement 099).

The motion sensor shall have a capability to output accountability data to authenticated entities at their request.

#### 4.4. Audit

The motion sensor shall, for events impairing its security, generate audit records of the events.

The events affecting the security of the motion sensor are the following:

- security breach attempts,
  - authentication failure,

---

*Changes to legislation: There are currently no known outstanding effects for the Council Regulation (EEC) No 3821/85. (See end of Document for details)*

---

- stored data integrity error,
- internal data transfer error,
- unauthorised case opening,
- hardware sabotage.
- sensor fault.

Audit records shall include the following data:

- date and time of the event,
- type of event,
- connected entity identity.

when required data is not available, an appropriate default indication shall be given (TBD by manufacturer).

The motion sensor shall send the generated audit records to the VU at the moment of their generation, and may also store them in its memory.

In the case where the motion sensor stores audit records, it shall ensure that 20 audit records will be maintained independent of audit storage exhaustion, and shall have a capability to output stored audit records to authenticated entities at their request.

#### 4.5. Accuracy

##### 4.5.1. Information flow control policy

The motion sensor shall ensure that motion data may only be processed and derived from sensor mechanical input.

##### 4.5.2. Internal data transfers

The requirements of this paragraph apply only if the motion sensor makes use of physically separated parts.

If data are transferred between physically separated parts of the motion sensor, the data shall be protected from modification.

Upon detection of a data transfer error during an internal transfer, transmission shall be repeated and the SEF shall generate an audit record of the event.

##### 4.5.3. Stored data integrity

The motion sensor shall check user data stored in its memory for integrity errors.

Upon detection of a stored user data integrity error, the SEF shall generate an audit record.

#### 4.6. Reliability of service

##### 4.6.1 Tests

All commands, actions, or test points, specific to the testing needs of the manufacturing phase shall be disabled or removed before the end of the manufacturing phase. It shall not be possible to restore them for later use.

The motion sensor shall run self-tests, during initial start-up, and during normal operation to verify its correct operation. The motion sensor self-tests shall include a verification of the integrity of security data and a verification of the integrity of stored executable code (if not in ROM).

Upon detection of an internal fault during self-test, the SEF shall generate an audit record (sensor fault).

#### 4.6.2. Software

There shall be no way to analyse or debug the motion sensor software in the field.

Inputs from external sources shall not be accepted as executable code.

#### 4.6.3. Physical protection

If the motion sensor is designed so that it can be opened, the motion sensor shall detect any case opening, even without external power supply for a minimum of 6 months. In such a case, the SEF shall generate an audit record of the event (It is acceptable that the audit record is generated and stored after power supply reconnection).

If the motion sensor is designed so that it cannot be opened, it shall be designed such that physical tampering attempts can be easily detected (e.g. through visual inspection).

The motion sensor shall detect specified (TBD by manufacturer) hardware sabotage.

In the case described above, the SEF shall generate an audit record and the motion sensor shall: (TBD by manufacturer).

#### 4.6.4. Power supply interruptions

The motion sensor shall preserve a secure state during power supply cut-off or variations.

#### 4.6.5. Reset conditions

In case of a power supply interruption, or if a transaction is stopped before completion, or on any other reset conditions, the motion sensor shall be reset cleanly.

#### 4.6.6. Data availability

The motion sensor shall ensure that access to resources is obtained when required and that resources are not requested nor retained unnecessarily.

#### 4.6.7. Multiple applications

If the motion sensor provides applications other than the tachograph application, all applications shall be physically and/or logically separated from each other. These applications shall not share security data. Only one task shall be active at a time.

#### 4.7. Data exchange

The motion sensor shall export motion data to the VU with associated security attributes, such that the VU will be able to verify its integrity and authenticity.

#### 4.8. Cryptographic support

The requirements of this paragraph are applicable only where needed, depending upon security mechanisms used and upon the manufacturer's solutions.

Any cryptographic operation performed by the motion sensor shall be in accordance with a specified algorithm and a specified key size.

If the motion sensor generates cryptographic keys, it shall be in accordance with specified cryptographic key generation algorithms and specified cryptographic key sizes.





**Changes to legislation:** There are currently no known outstanding effects for the Council Regulation (EEC) No 3821/85. (See end of Document for details)

Software Upgrades										X								
Security Enforcing Functions																		
Identification and authentication																		
UIA_x101 Entities identification										X				X		X		X
UIA_x102 Entities identity														X		X		
UIA_103 VU identity															X			
UIA_x104 Entities authentication										X				X		X		X
UIA_x105 re-authentication										X				X		X		X
UIA_x106 Unforgeable authentication										X				X		X		
UIA_107 Authentication failure										X					X			X
Access control																		
ACCx101 Access control policy										X				X		X		
ACC_102 Motion sensor ID														X		X		
ACC_103 User data														X		X		
ACC_104 Security Data										X				X		X		
ACCx105 File structure and										X				X		X		





*Changes to legislation: There are currently no known outstanding effects for the Council Regulation (EEC) No 3821/85. (See end of Document for details)*

Data exchange															
DEX_101														x	
Secured motion data export														x	
Cryptographic support															
CSP_101														x	x
Algorithms														x	x
CSP_102														x	x
key generation														x	x
CSP_103														x	x
key distribution														x	x
CSP_104														x	x
key access														x	x
CSP_105														x	x
key destruction														x	x

## VEHICLE UNIT GENERIC SECURITY TARGET

### 1. Introduction

This document contains a description of the vehicle unit, of the threats it must be able to counteract and of the security objectives it must achieve. It specifies the required security enforcing functions. It states the claimed minimum strength of security mechanisms and the required level of assurance for the development and the evaluation.

Requirements referred to in the document, are those of the body of Annex I B. For clarity of reading, duplication sometimes arises between Annex I B body requirements and security target requirements. In case of ambiguity between a security target requirement and the Annex I B body requirement referred by this security target requirement, the Annex I B body requirement shall prevail.

Annex I B body requirements not referred by security targets are not the subject of security enforcing functions.

Unique labels have been assigned to threats, objectives, procedural means and SEF specifications for the purpose of traceability to development and evaluation documentation.

### 2. Abbreviations, definitions and references

#### 2.1. Abbreviations

PIN	Personal identification number
ROM	Read only memory
SEF	Security enforcing function
TBD	To be defined

---

**Changes to legislation:** There are currently no known outstanding effects for the Council Regulation (EEC) No 3821/85. (See end of Document for details)

---

TOE Target of evaluation  
VU Vehicle Unit.

## 2.2. Definitions

Digital tachograph Motion data	Recording equipment The data exchanged with the motion sensor, representative of speed and distance travelled
Physically separated parts	Physical components of the VU that are distributed in the vehicle as opposed to physical components gathered into the VU casing
Security data	The specific data needed to support security enforcing functions (e.g. crypto keys)
System	Equipment, people or organisations, involved in any way with the recording equipment
User	Users are to be understood as human user of the equipment. Normal users of the VU comprise drivers, controllers, workshops and companies
User data	Any data, other than security data, recorded or stored by the VU, required by Chapter III.12.

## 2.3. References

ITSEC ITSEC Information Technology Security Evaluation Criteria 1991.

## 3. Product rationale

### 3.1. Vehicle unit description and method of use

The VU is intended to be installed in road transport vehicles. Its purpose is to record, store, display, print and output data related to driver activities.

It is connected to a motion sensor with which it exchanges vehicle's motion data.

Users identify themselves to the VU using tachograph cards.

The VU records and stores user activities data in its data memory, it also records user activities data in tachograph cards.

The VU outputs data to display, printer and external devices.

The vehicle unit's operational environment while installed in a vehicle is described in the following figure:

*Changes to legislation: There are currently no known outstanding effects for the Council Regulation (EEC) No 3821/85. (See end of Document for details)*

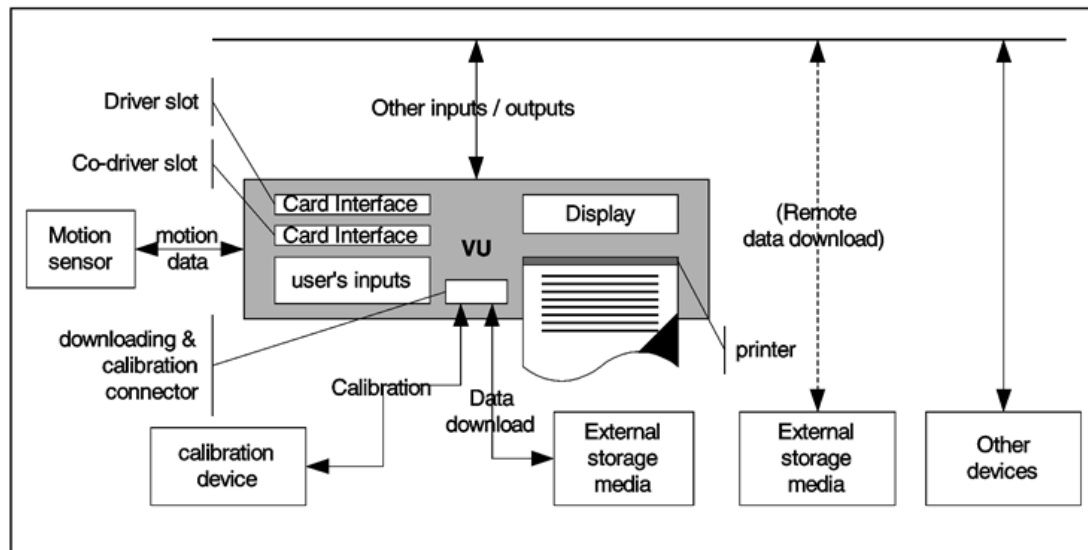

The VU general characteristics, functions and mode of operations are described in Chapter II of Annex I B.

The VU functional requirements are specified in Chapter III of Annex I B.

The typical VU is described in the following figure:

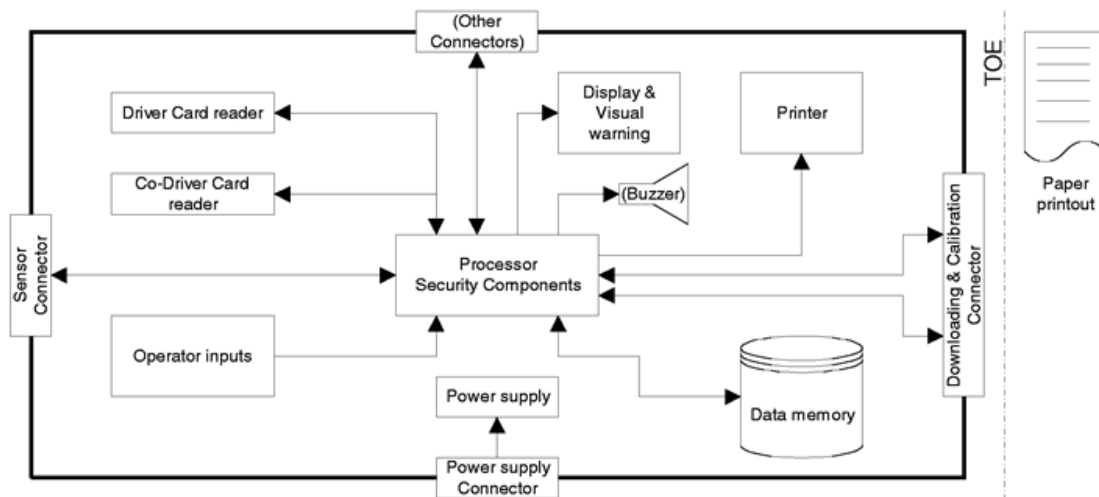

It must be noted that although the printer mechanism is part of the TOE, the paper document once produced is not.

### 3.2. Vehicle unit life cycle

The typical life cycle of the VU is described in the following figure:

**Changes to legislation:** There are currently no known outstanding effects for the Council Regulation (EEC) No 3821/85. (See end of Document for details)

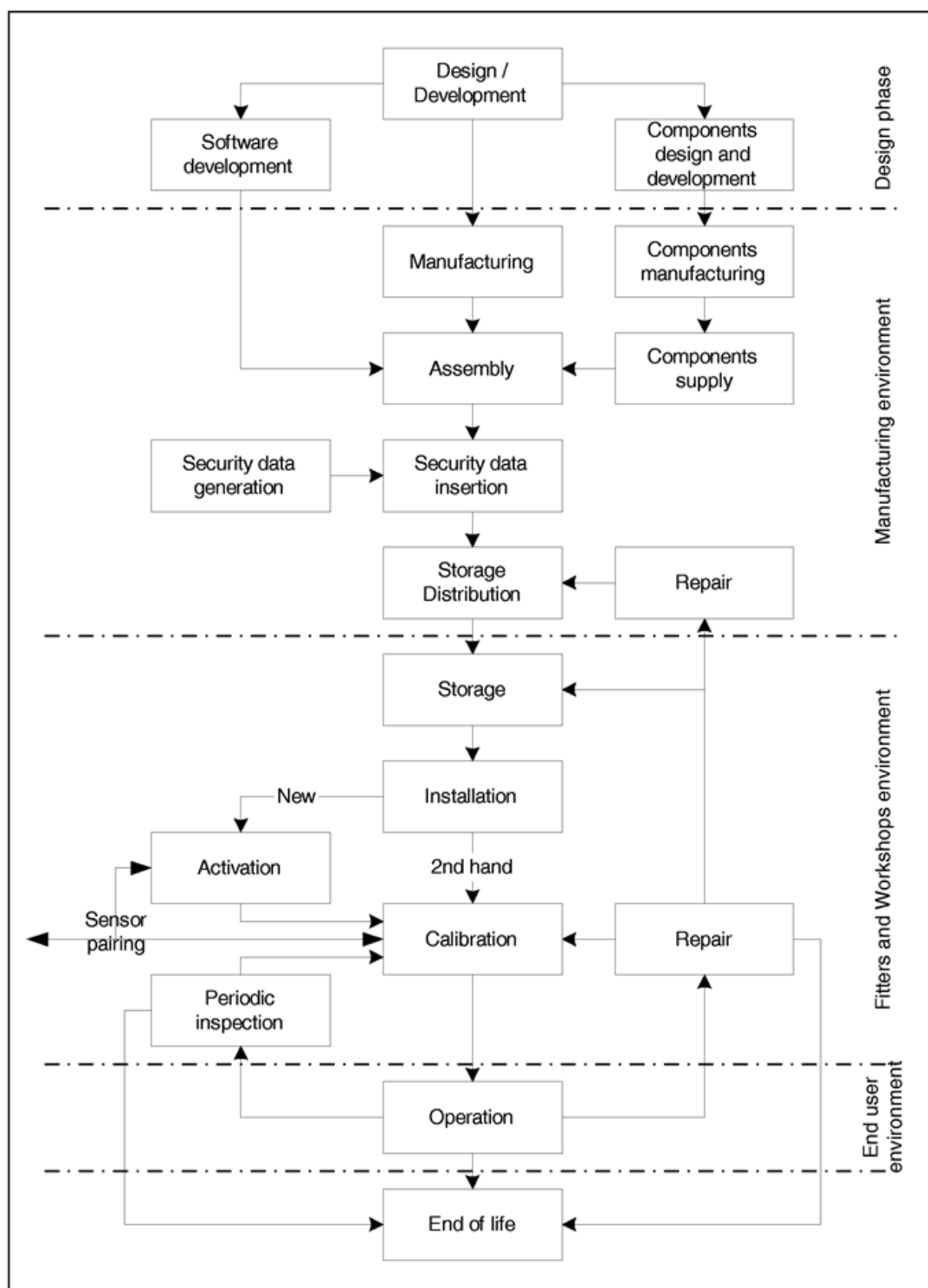

### 3.3. Threats

This paragraph describes the threats the VU may face.

#### 3.3.1. Threats to identification and access control policies

---

*Changes to legislation: There are currently no known outstanding effects for the Council Regulation (EEC) No 3821/85. (See end of Document for details)*

---

T.Access Users could try to access functions not allowed to them (e.g. drivers gaining access to calibration function)

T.Identification Users could try to use several identifications or no identification.

### 3.3.2. Design related threats

T.Faults Faults in hardware, software, communication procedures could place the VU in unforeseen conditions compromising its security

T.Tests The use of non invalidated test modes or of existing back doors could compromise the VU security

T.Design Users could try to gain illicit knowledge of design either from manufacturer's material (through theft, bribery, ...) or from reverse engineering

### 3.3.3. Operation oriented threats

T.Calibration\_Parameters Users could try to use mis-calibrated equipment (through calibration data modification, or through organisational weaknesses)

T.Card\_Data\_Exchange Users could try to modify data while exchanged between VU and tachograph cards (addition, modification, deletion, replay of signal)

T.Clock Users could try to modify internal clock

T.Environment Users could compromise the VU security through environmental attacks (thermal, electromagnetic, optical, chemical, mechanical, ...)

T.Fake\_Devices Users could try to connect fake devices (motion sensor, smart cards) to the VU

T.Hardware Users could try to modify VU hardware

T.Motion\_Data Users could try to modify the vehicle's motion data (addition, modification, deletion, replay of signal)

T.Non\_Activated Users could use non activated equipment

T.Output\_Data Users could try to modify data output (print, display or download)

T.Power\_Supply Users could try to defeat the VU security objectives by modifying (cutting, reducing, increasing) its power supply

T.Security\_Data Users could try to gain illicit knowledge of security data during security data generation or transport or storage in the equipment

T.Software Users could try to modify VU software

T.Stored\_Data Users could try to modify stored data (security or user data).

## 3.4. Security objectives

The main security objective of the digital tachograph system is the following:

O.Main The data to be checked by control authorities must be available and reflect fully and accurately the activities of controlled drivers and vehicles in terms of driving, work, availability and rest periods and in terms of vehicle speed

Therefore the security objectives of the VU, contributing to the global security objective, are the following:

O.VU\_Main The data to be measured and recorded and then to be checked by control authorities must be available and reflect accurately the activities of controlled drivers and vehicles in terms of driving, work, availability and rest periods and in terms of vehicle speed

O.VU\_Export The VU must be able to export data to external storage media in such a way as to allow for verification of their integrity and authenticity.

## 3.5. Information technology security objectives



---

*Changes to legislation: There are currently no known outstanding effects for the Council Regulation (EEC) No 3821/85. (See end of Document for details)*

---

The specific IT security objectives of the VU contributing to its main security objectives, are the following:

O.Access	The VU must control user access to functions and data
O.Accountability	The VU must collect accurate accountability data
O.Audit	The VU must audit attempts to undermine system security and should trace them to associated users
O.Authentication	The VU should authenticate users and connected entities (when a trusted path needs to be established between entities)
O.Integrity	The VU must maintain stored data integrity
O.Output	The VU must ensure that data output reflects accurately data measured or stored
O.Processing	The VU must ensure that processing of inputs to derive user data is accurate
O.Reliability	The VU must provide a reliable service
O.Secured_Data_Exchange	The VU must secure data exchanges with the motion sensor and with tachograph cards.

### 3.6. Physical, personnel or procedural means

This paragraph describes physical, personnel or procedural requirements that contribute to the security of the VU.

#### 3.6.1. Equipment design

M.Development	VU developers must ensure that the assignment of responsibilities during development is done in a manner which maintains IT security
M.Manufacturing	VU manufacturers must ensure that the assignment of responsibilities during manufacturing is done in a manner which maintains IT security, and that during the manufacturing process the VU is protected from physical attacks which might compromise IT security.

#### 3.6.2. Equipment delivery and activation

M.Delivery	VU manufacturers, vehicle manufacturers and fitters or workshops must ensure that handling of non activated VUs is done in a manner which maintains VU security
M.Activation	Vehicle manufacturers and fitters or workshops must activate the VU after its installation before the vehicle leaves the premises where installation took place.

#### 3.6.3. Security data generation and delivery

M.Sec_Data_Generation	Security data generation algorithms must be accessible to authorised and trusted persons only
M.Sec_Data_Transport	Security data must be generated, transported, and inserted into the VU, in such a way to preserve its appropriate confidentiality and integrity.

#### 3.6.4. Cards delivery

M.Card_Availability	Tachograph cards must be available and delivered to authorised persons only
M.Driver_Card_Uniqueness	Drivers must possess, at one time, <i>one</i> valid driver card only
M.Card_Traceability	Card delivery must be traceable (white lists, black lists), and black lists must be used during security audits.

#### 3.6.5. Recording equipment installation, calibration, and inspection

---

*Changes to legislation: There are currently no known outstanding effects for the Council Regulation (EEC) No 3821/85. (See end of Document for details)*

---

M.Approved\_Workshops Installation, calibration and repair of recording equipment must be carried by trusted and approved fitters or workshops

M.Regular\_Inspections Recording equipment must be periodically inspected and calibrated

M.Faithful\_Calibration Approved fitters and workshops must enter proper vehicle parameters in recording equipment during calibration.

### 3.6.6. Equipment operation

M.Faithful\_Drivers Drivers must play by the rules and act responsibly (e.g. use their driver cards, properly select their activity for those that are manually selected, ...).

### 3.6.7. Law enforcement control

M.Controls Law enforcement controls must be performed regularly and randomly, and must include security audits.

### 3.6.8. Software upgrades

M.Software\_Upgrade Software revisions must be granted security certification before they can be implemented in a VU.

## 4. Security enforcing functions

### 4.1. Identification and authentication

#### 4.1.1. Motion sensor identification and authentication

The VU shall be able to establish, for every interaction, the identity of the motion sensor it is connected to.

The identity of the motion sensor shall consist of the sensor approval number and the sensor serial number.

The VU shall authenticate the motion sensor it is connected to:

- at motion sensor connection,
- at each calibration of the recording equipment,
- at power supply recovery.

Authentication shall be mutual and triggered by the VU.

The VU shall periodically (period TBD by manufacturer and more frequently than once per hour) re-identify and re-authenticate the motion sensor it is connected to, and ensure that the motion sensor identified during the last calibration of the recording equipment has not been changed.

The VU shall detect and prevent use of authentication data that has been copied and replayed.

After (TBD by manufacturer and not more than 20) consecutive unsuccessful authentication attempts have been detected, and/or after detecting that the identity of the motion sensor has changed while not authorised (i.e. while not during a calibration of the recording equipment), the SEF shall:

- generate an audit record of the event,
- warn the user,
- continue to accept and use non secured motion data sent by the motion sensor.

#### 4.1.2. User identification and authentication

---

*Changes to legislation: There are currently no known outstanding effects for the Council Regulation (EEC) No 3821/85. (See end of Document for details)*

---

The VU shall permanently and selectively track the identity of two users, by monitoring the tachograph cards inserted in respectively the driver slot and the co-driver slot of the equipment.

The user identity shall consist of:

- a user group:
  - DRIVER (driver card),
  - CONTROLLER (control card),
  - WORKSHOP (workshop card),
  - COMPANY (company card),
  - UNKNOWN (no card inserted),
- a user ID, composed of:
  - the card issuing Member State code and of the card number,
  - UNKNOWN if user group is UNKNOWN.

UNKNOWN identities may be implicitly or explicitly known.

The VU shall authenticate its users at card insertion.

The VU shall re-authenticate its users:

- at power supply recovery,
- periodically or after occurrence of specific events (TBD by manufacturers and more frequently than once per day).

Authentication shall be performed by means of proving that the card inserted is a valid tachograph card, possessing security data that only the system could distribute. Authentication shall be mutual and triggered by the VU.

In addition to the above, workshops shall be required to be successfully authenticated through a PIN check. PINs shall be at least 4 characters long.

Note: In the case the PIN is transferred to the VU from an outside equipment located in the vicinity of the VU, PIN confidentiality need not be protected during the transfer.

The VU shall detect and prevent use of authentication data that has been copied and replayed.

After 5 consecutive unsuccessful authentication attempts have been detected, the SEF shall:

- generate an audit record of the event,
- warn the user,
- assume the user as UNKNOWN, and the card as non valid (definition z) and requirement 007).

#### 4.1.3. Remotely connected company identification and authentication

Company remote connection capability is optional. This paragraph therefore applies only if this feature is implemented.

For every interaction with a remotely connected company, the VU shall be able to establish the company's identity.

The remotely connected company's identity shall consist of its company card issuing Member State code and of its company card number.

The VU shall successfully authenticate the remotely connected company before allowing any data export to it.

---

*Changes to legislation: There are currently no known outstanding effects for the Council Regulation (EEC) No 3821/85. (See end of Document for details)*

---

Authentication shall be performed by means of proving that the company owns a valid company card, possessing security data that only the system could distribute.

The VU shall detect and prevent use of authentication data that has been copied and replayed.

After 5 consecutive unsuccessful authentication attempts have been detected, the VU shall:

— warn the remotely connected company.

#### 4.1.4. Management device identification and authentication

VU manufacturers may foresee dedicated devices for additional VU management functions (e.g. Software upgrading, security data reloading, ...). This paragraph therefore applies only if this feature is implemented.

For every interaction with a management device, the VU shall be able to establish the device identity.

Before allowing any further interaction, the VU shall successfully authenticate the management device.

The VU shall detect and prevent use of authentication data that has been copied and replayed.

#### 4.2. Access control

Access controls ensure that information is read from, created in, or modified into the TOE only by those authorised to do so.

It must be noted that the user data recorded by the VU, although presenting privacy or commercial sensitivity aspects, are not of a confidential nature. Therefore, the functional requirement related to data read access rights (requirement 011) is not the subject of a security enforcing function.

##### 4.2.1. Access control policy

The VU shall manage and check access control rights to functions and to data.

##### 4.2.2. Access rights to functions

The VU shall enforce the mode of operation selection rules (requirements 006 to 009).

The VU shall use the mode of operation to enforce the functions access control rules (requirement 010).

##### 4.2.3. Access rights to data

The VU shall enforce the VU identification data write access rules (requirement 076)

The VU shall enforce the paired motion sensor identification data write access rules (requirements 079 and 155)

After the VU activation, the VU shall ensure that only in calibration mode, may calibration data be input into the VU and stored into its data memory (requirements 154 and 156).

After the VU activation, the VU shall enforce calibration data write and delete access rules (requirement 097).

After the VU activation, the VU shall ensure that only in calibration mode, may time adjustment data be input into the VU and stored into its data memory (This requirement does not apply to small time adjustments allowed by requirements 157 and 158).

---

*Changes to legislation: There are currently no known outstanding effects for the Council Regulation (EEC) No 3821/85. (See end of Document for details)*

---

After the VU activation, the VU shall enforce time adjustment data write and delete access rules (requirement 100).

The VU shall enforce appropriate read and write access rights to security data (requirement 080).

#### 4.2.4. File structure and access conditions

Application and data files structure and access conditions shall be created during the manufacturing process, and then locked from any future modification or deletion.

#### 4.3. Accountability

The VU shall ensure that drivers are accountable for their activities (requirements 081, 084, 087, 105a, 105b, 109 and 109a).

The VU shall hold permanent identification data (requirement 075).

The VU shall ensure that workshops are accountable for their activities (requirements 098, 101 and 109).

The VU shall ensure that controllers are accountable for their activities (requirements 102, 103 and 109).

The VU shall record odometer data (requirement 090) and detailed speed data (requirement 093).

The VU shall ensure that user data related to requirements 081 to 093 and 102 to 105b inclusive are not modified once recorded, except when becoming oldest stored data to be replaced by new data.

The VU shall ensure that it does not modify data already stored in a tachograph card (requirements 109 and 109a) except for replacing oldest data by new data (requirement 110) or in the case described in Appendix 1 Paragraph 2.1 Note.

#### 4.4. Audit

Audit capabilities are required only for events that may indicate a manipulation or a security breach attempt. It is not required for the normal exercising of rights even if relevant to security.

The VU shall, for events impairing the security of the VU, record those events with associated data (requirements 094, 096 and 109).

The events affecting the security of the VU are the following:

- Security breach attempts,
  - motion sensor authentication failure,
  - tachograph card authentication failure,
  - unauthorised change of motion sensor,
  - card data input integrity error,
  - stored user data integrity error,
  - internal data transfer error,
  - unauthorised case opening,
  - hardware sabotage,
- last card session not correctly closed,
- motion data error event,
- power supply interruption event,
- VU internal fault.

---

*Changes to legislation: There are currently no known outstanding effects for the Council Regulation (EEC) No 3821/85. (See end of Document for details)*

---

The VU shall enforce audit records storage rules (requirement 094 and 096).

The VU shall store audit records generated by the motion sensor in its data memory.

It shall be possible to print, display and download audit records.

#### 4.5. Object re-use

The VU shall ensure that temporary storage objects can be re-used without this involving inadmissible information flow.

#### 4.6. Accuracy

##### 4.6.1. Information flow control policy

The VU shall ensure that user data related to requirements 081, 084, 087, 090, 093, 102, 104, 105, 105a and 109 may only be processed from the right input sources:

- vehicle motion data,
- VU's real time clock,
- recording equipment calibration parameters,
- tachograph cards,
- user's inputs.

The VU shall ensure that user data related to requirement 109a may only be entered for the period last card withdrawal — current insertion (requirement 050a).

##### 4.6.2. Internal data transfers

The requirements of this paragraph apply only if the VU makes use of physically separated parts.

If data are transferred between physically separated parts of the VU, the data shall be protected from modification.

Upon detection of a data transfer error during an internal transfer, transmission shall be repeated and the SEF shall generate an audit record of the event.

##### 4.6.3. Stored data integrity

The VU shall check user data stored in the data memory for integrity errors.

Upon detection of a stored user data integrity error, the SEF shall generate an audit record.

#### 4.7. Reliability of service

##### 4.7.1. Tests

All commands, actions or test points, specific to the testing needs of the manufacturing phase of the VU shall be disabled or removed before the VU activation. It shall not be possible to restore them for later use.

The VU shall run self tests, during initial start-up, and during normal operation to verify its correct operation. The VU self tests shall include a verification of the integrity of security data and a verification of the integrity of stored executable code (if not in ROM).

Upon detection of an internal fault during self test, the SEF shall:

- generate an audit record (except in calibration mode) (VU internal fault),
- Preserve the stored data integrity.

##### 4.7.2. Software

---

*Changes to legislation: There are currently no known outstanding effects for the Council Regulation (EEC) No 3821/85. (See end of Document for details)*

---

There shall be no way to analyse or debug software in the field after the VU activation.

Inputs from external sources shall not be accepted as executable code.

#### 4.7.3. Physical protection

If the VU is designed so that it can be opened, the VU shall detect any case opening, except in calibration mode, even without external power supply for a minimum of six months. In such a case, the SEF shall generate an audit record (It is acceptable that the audit record is generated and stored after power supply reconnection).

If the VU is designed so that it cannot be opened, it shall be designed such that physical tampering attempts can be easily detected (e.g. through visual inspection).

After its activation, the VU shall detect specified (TBD by manufacturer) hardware sabotage.

In the case described above, the SEF shall generate an audit record and the VU shall: (TBD by manufacturer).

#### 4.7.4. Power supply interruptions

The VU shall detect deviations from the specified values of the power supply, including cut-off.

In the case described above, the SEF shall:

- generate an audit record (except in calibration mode),
- preserve the secure state of the VU,
- maintain the security functions, related to components or processes still operational,
- preserve the stored data integrity.

#### 4.7.5. Reset conditions

In case of a power supply interruption, or if a transaction is stopped before completion, or on any other reset conditions, the VU shall be reset cleanly.

#### 4.7.6. Data availability

The VU shall ensure that access to resources is obtained when required and that resources are not requested nor retained unnecessarily.

The VU must ensure that cards cannot be released before relevant data have been stored to them (requirements 015 and 016)

In the case described above, the SEF shall generate an audit record of the event.

#### 4.7.7. Multiple applications

If the VU provides applications other than the tachograph application, all applications shall be physically and/or logically separated from each other. These applications shall not share security data. Only one task shall be active at a time.

#### 4.8. Data exchange

This paragraph addresses data exchange between the VU and connected devices.

##### 4.8.1. Data exchange with motion sensor

The VU shall verify the integrity and authenticity of motion data imported from the motion sensor

---

*Changes to legislation: There are currently no known outstanding effects for the Council Regulation (EEC) No 3821/85. (See end of Document for details)*

---

Upon detection of a motion data integrity or authenticity error, the SEF shall:

- generate an audit record,
- continue to use imported data.

#### 4.8.2. Data exchange with tachograph cards

The VU shall verify the integrity and authenticity of data imported from tachograph cards.

Upon detection of card data integrity or authenticity error, the VU shall:

- generate an audit record,
- not use the data.

The VU shall export data to tachograph smart cards with associated security attributes such that the card will be able to verify its integrity and authenticity.

#### 4.8.3. Data exchange with external storage media (downloading function)

The VU shall generate an evidence of origin for data downloaded to external media.

The VU shall provide a capability to verify the evidence of origin of downloaded data to the recipient.

The VU shall download data to external storage media with associated security attributes such that downloaded data integrity and authenticity can be verified.

#### 4.9. Cryptographic support

The requirements of this paragraph are applicable only where needed, depending upon security mechanisms used and upon the manufacturer's solutions.

Any cryptographic operation performed by the VU shall be in accordance with a specified algorithm and a specified key size.

If the VU generates cryptographic keys, it shall be in accordance with specified cryptographic key generation algorithms and specified cryptographic key sizes.

If the VU distributes cryptographic keys, it shall be in accordance with specified key distribution methods.

If the VU accesses cryptographic keys, it shall be in accordance with specified cryptographic keys access methods.

If the VU destroys cryptographic keys, it shall be in accordance with specified cryptographic keys destruction methods.

#### 5. Definition of security mechanisms

Required security mechanisms are specified in Appendix 11.

All other security mechanisms are to be defined by manufacturers.

#### 6. Minimum strength of security mechanisms

The minimum strength of the Vehicle Unit security mechanisms is *High*, as defined in (ITSEC).

#### 7. Level of assurance

The target level of assurance for the Vehicle Unit is ITSEC level E3, as defined in (ITSEC).

#### 8. Rationale



**Changes to legislation:** There are currently no known outstanding effects for the Council Regulation (EEC) No 3821/85. (See end of Document for details)

The following matrixes give a rationale for the SEFs by showing:

- which SEFs or means counteract which threats,
- which SEFs fulfil which IT security objectives.

	Threats														IT Objectives														
	Access	Identification	Faults	Tests	Design	Calibration_Parameters	Card_Data_Exchange	Clock	Environment	Fake_Devices	Hardware	Motion_Data	Non_Activated	Output_Data	Power_Supply (intentionally left blank)	Security_Data	Software	Stored_Data	Access	Accountability	Audit	Authentication	Integrity	Output	Processing	Reliability	Secured_Data_Exchange		
<b>Physical personnel procedural means</b>																													
Development			x	x	x																								
Manufacturing				x	x																								
Delivery													x																
Activation	x											x																	
Security data generation																x													
Security data transport																x													
Card availability	x																												
One driver card	x																												
Card traceability	x																												
Approved workshops						x	x																						
Regular inspection calibration						x	x			x				x			x												
Faithful workshops						x	x																						
Faithful drivers	x																												
Law enforcement controls	x					x	x	x	x	x	x	x	x	x	x	x	x												
Software upgrade																	x												
<b>Security-enforcing functions</b>																													
<b>Identification and authentication</b>																													
UIA_201 Sensor identification										x	x											x							x
UIA_202 Sensor identity										x	x											x							
UIA_203 Sensor authentication										x	x											x							x
UIA_204 Sensor re-identification and re-authentication										x	x											x							x
UIA_205 Unforgeable authentication										x	x											x							
UIA_206 Authentication failure										x	x											x							x
UIA_207 Users identification	x	x								x											x		x						x
UIA_208 User identity	x	x								x											x		x						
UIA_209 User authentication	x	x								x											x		x						x
UIA_210 User re-authentication	x	x								x											x		x						x
UIA_211 Authentication means	x	x								x											x		x						
UIA_212 PIN checks	x	x				x	x														x		x						
UIA_213 Unforgeable authentication	x	x								x											x		x						
UIA_214 Authentication failure	x	x								x												x							
UIA_215 Remote user identification	x	x																			x		x						x
UIA_216 Remote user identity	x	x																			x		x						
UIA_217 Remote user authentication	x	x																			x		x						x
UIA_218 Authentication means	x	x																			x		x						
UIA_219 Unforgeable authentication	x	x																			x		x						
UIA_220 Authentication failure	x	x																											

XI



**Changes to legislation:** There are currently no known outstanding effects for the Council Regulation (EEC) No 3821/85. (See end of Document for details)

		Threats																IT Objectives										
		Access	Identification	Faults	Tests	Design	Calibration_Parameters	Card_Data_Exchange	Clock	Environment	Fake_Devices	Hardware	Motion_Data	Non_Activated	Output_Data	Power_Supply (intentionally left blank)	Security_Data	Software	Stored_Data	Access	Accountability	Audit	Authentication	Integrity	Output	Processing	Reliability	Secured_Data_Exchange
<b>Accuracy</b>																												
ACR_201	Information flow control policy						x			x		x															x	x
ACR_202	Internal transfers														x										x	x	x	
ACR_203	Internal transfers														x							x						
ACR_204	Stored data integrity																		x				x					x
ACR_205	Stored data integrity																		x			x						
<b>Reliability</b>																												
RLB_201	Manufacturing tests			x	x																							x
RLB_202	Self tests		x							x					x			x										x
RLB_203	Self tests									x					x			x				x						
RLB_204	Software analysis					x												x										x
RLB_205	Software input																	x						x	x	x		
RLB_206	Case opening				x				x	x				x			x	x	x						x			x
RLB_207	Hardware sabotage									x																		x
RLB_208	Hardware sabotage										x											x						
RLB_209	Power supply interruptions															x												x
RLB_210	Power supply interruptions															x						x						
RLB_211	Reset			x																								x
RLB_212	Data availability																									x	x	
RLB_213	Card release																											x
RLB_214	Card session not correctly closed																					x						
RLB_215	Multiple applications																											x
<b>Data exchange</b>																												
DEX_201	Secured motion data import																											x
DEX_202	Secured motion data import																						x					
DEX_203	Secured card data import						x																					x
DEX_204	Secured card data import						x																x					
DEX_205	Secured data export to cards						x																					x
DEX_206	Evidence of origin														x											x		
DEX_207	Evidence of origin														x											x		
DEX_208	Secured export to external media														x											x		

*Changes to legislation:* There are currently no known outstanding effects for the Council Regulation (EEC) No 3821/85. (See end of Document for details)

		Threats															IT Objectives													
		Access	Identification	Faults	Tests	Design	Calibration_Parameters	Card_Data_Exchange	Clock	Environment	Fake_Devices	Hardware	Motion_Data	Non_Activated	Output_Data	Power_Supply (intentionally left blank)	Security_Data	Software	Stored_Data	Access	Accountability	Audit	Authentication	Integrity	Output	Processing	Reliability	Secured_Data_Exchange		
<b>Cryptographic support</b>																														
CSP_201	Algorithms																												x	x
CSP_202	key generation																												x	x
CSP_203	key distribution																												x	x
CSP_204	key access																												x	x
CSP_205	key destruction																												x	x

TACHOGRAPH CARD GENERIC SECURITY TARGET

1. Introduction

This document contains a description of the tachograph card, of the threats it must be able to counteract and of the security objectives it must achieve. It specifies the required security enforcing functions. It states the claimed minimum strength of security mechanisms, and the required level of assurance for the development and the evaluation.

Requirements referred to in the document, are those of the body of Annex I B. For clarity of reading, duplication sometimes arises between Annex I B body requirements and security target requirements. In case of ambiguity between a security target requirement and the Annex I B requirement referred by this security target requirement, the Annex I B body requirement shall prevail.

Annex I B body requirements not referred by security targets are not the subject of security enforcing functions.

A tachograph card is a standard smart card carrying a dedicated tachograph application, and shall comply with up-to-date functional and assurance security requirements applicable to smart cards. This security target therefore incorporates only the extra security requirements needed by the tachograph application.

Unique labels have been assigned to threats, objectives, procedural means and SEF specifications for the purpose of traceability to development and evaluation documentation.

2. Abbreviations, definitions and references

2.1. Abbreviations

- IC Integrated Circuit (electronic component designed to perform processing and/or memory functions)
- OS Operating system
- PIN Personal identification number
- ROM Read only memory
- SFP Security functions policy
- TBD To be defined
- TOE Target of evaluation
- TSF TOE security function

---

**Changes to legislation:** There are currently no known outstanding effects for the Council Regulation (EEC) No 3821/85. (See end of Document for details)

---

VU	Vehicle unit.
2.2.	Definitions
Digital tachograph	Recording equipment.
Sensitive data	Data stored by the tachograph card that need to be protected for integrity, unauthorised modification and confidentiality (where applicable for security data). Sensitive data includes security data and user data.
Security data	The specific data needed to support security enforcing functions (e.g. crypto keys).
System	Equipment, people or organisations involved in any way with the recording equipment.
User	Any entity (human user or external IT entity) outside the TOE that interacts with the TOE (when not used in the expression ‘user data’).
User data	Sensitive data stored in the tachograph card, other than security data. User data include identification data and activity data.
Identification data	Identification data include card identification data and cardholder identification data.
Card identification data	User data related to card identification as defined by requirements 190, 191, 192, 194, 215, 231 and 235.
Cardholder identification data	User data related to cardholder identification as defined by requirements 195, 196, 216, 232 and 236.
Activity data	Activity data include cardholder activities data, events and faults data and control activity data.
Cardholder activities data	User data related to the activities carried by the cardholder as defined by requirements 197, 199, 202, 212, 212a, 217, 219, 221, 226, 227, 229, 230a, 233 and 237.
Events and faults data	User data related to events or faults as defined by requirements 204, 205, 207, 208 and 223.
Control activity data	User data related to law enforcement controls as defined by requirements 210 and 225.
2.3.	References
ITSEC	ITSEC Information Technology Security Evaluation Criteria 1991
IC PP	Smartcard Integrated Circuit Protection Profile — version 2.0 — issue September 1998. Registered at French certification body under the number PP/9806
ES PP	Smart Card Integrated Circuit With Embedded Software Protection Profile — version 2.0 — issue June 99. Registered at French certification body under the number PP/9911

### 3. Product Rationale

#### 3.1. Tachograph card description and method of use

A tachograph card is a smart card, as described in (IC PP) and (ES PP), carrying an application intended for its use with the recording equipment.

The basic functions of the tachograph card are:

- to store card identification and card holder identification data. These data are used by the vehicle unit to identify the cardholder, provide accordingly functions and data access rights, and ensure cardholder accountability for his activities,
- to store cardholder activities data, events and faults data and control activities data, related to the cardholder.

---

*Changes to legislation: There are currently no known outstanding effects for the Council Regulation (EEC) No 3821/85. (See end of Document for details)*

---

A tachograph card is therefore intended to be used by a card interface device of a vehicle unit. It may also be used by any card reader (e.g. of a personal computer) which shall have full read access right on any user data.

During the end-usage phase of a tachograph card life cycle (phase 7 of life-cycle as described in (ES PP)), vehicle units only may write user data to the card.

The functional requirements for a tachograph card are specified in Annex I B body text and Appendix 2.

### 3.2. Tachograph card life cycle

The tachograph card life cycle conforms to smart card life cycle described in (ES PP).

### 3.3. Threats

In addition to the smart card general threats listed in (ES PP) and (IC PP), the tachograph card may face the following threats:

#### 3.3.1. Final aims

The final aim of attackers will be to modify user data stored within the TOE.

T.Ident_Data	A successful modification of identification data held by the TOE (e.g. the type of card, or the card expiry date or the cardholder identification data) would allow a fraudulent use of the TOE and would be a major threat to the global security objective of the system.
T.Activity_Data	A successful modification of activity data stored in the TOE would be a threat to the security of the TOE.
T.Data_Exchange	A successful modification of activity data (addition, deletion, modification) during import or export would be a threat to the security of the TOE.

#### 3.3.2. Attack paths

TOE's assets may be attacked by:

- trying to gain illicit knowledge of TOE's hardware and software design and especially of its security functions or security data. Illicit knowledge may be gained through attacks to designer or manufacturer material (theft, bribery, ...) or through direct examination of the TOE (physical probing, inference analysis, ...),
- taking advantage of weaknesses in TOE design or realisation (exploit errors in hardware, errors in software, transmission faults, errors induced in TOE by environmental stress, exploit weaknesses of security functions such as authentication procedures, data access control, cryptographic operations, ...),
- modifying the TOE or its security functions through physical, electrical or logical attacks or combination of these.

### 3.4. Security Objectives

The main security objective of the entire digital tachograph system is the following:

O.Main	The data to be checked by control authorities must be available and reflect fully and accurately the activity of controlled drivers and vehicles in terms of driving, work, availability and rest period and in terms of vehicle speed.
--------	---

Therefore the main security objectives of the TOE, contributing to this global security objective are the following:

---

**Changes to legislation:** There are currently no known outstanding effects for the Council Regulation (EEC) No 3821/85. (See end of Document for details)

---

O.Card\_Identification\_Data TOE must preserve card identification data and cardholder identification data stored during card personalisation process,

O.Card\_Activity\_Storage The TOE must preserve user data stored in the card by vehicle units.

### 3.5. Information technology security objectives

In addition to the smart card general security objectives listed in (ES PP) and (IC PP), the specific IT security objectives of the TOE that contributes to its main security objectives during its end-usage life-cycle phase are the following:

O.Data\_Access The TOE must limit user data write access rights to authenticated vehicle units,

O.Secure\_Communication The TOE must be able to support secure communication protocols and procedures between the card and the card interface device when required by the application.

### 3.6. Physical, personnel or procedural means

The physical, personnel or procedural requirements that contribute to the security of the TOE are listed in (ES PP) and (IC PP) (chapters security objectives for the environment).

## 4. Security enforcing functions

This paragraph refines some of the permitted operations such as assignment or selection of (ES PP) and provides additional SEF functional requirements.

### 4.1. Compliance to protection profiles

The TOE shall comply with (IC PP).

The TOE shall comply with (ES PP) as refined further.

### 4.2. User identification and authentication

The card must identify the entity in which it is inserted and know whether it is an authenticated vehicle unit or not. The card may export any user data whatever the entity it is connected to, except the control [F<sup>24</sup> and the company card] which may export card holder identification data to authenticated vehicle units only (such that a controller is ensured that the vehicle unit is not a fake one by seeing his name on display or printouts).

#### Textual Amendments

**F24** Inserted by [Commission Regulation \(EC\) No 432/2004 of 5 March 2004 adapting for the eighth time to technical progress Council Regulation \(EEC\) No 3821/85 of 20 December 1985 on recording equipment in road transport \(Text with EEA relevance\).](#)

#### 4.2.1. User identification

**Assignment** (FIA\_UID.1.1) *List of TSF mediated actions:* none.

[<sup>X1</sup>**Assignment** (FIA\_ATD.1.1) *List of security attributes:*

USER\_GROUP : VEHICLE\_UNIT, NON\_VEHICLE\_UNIT,  
 USER\_ID : Vehicle Registration Number (VRN) and registering Member State code  
 (USER\_ID is known for USER\_GROUP = VEHICLE\_UNIT only).]

#### 4.2.2. User authentication

---

*Changes to legislation: There are currently no known outstanding effects for the Council Regulation (EEC) No 3821/85. (See end of Document for details)*

---

**Assignment** (FIA\_UAU.1.1) *List of TSF mediated actions:*

- Driver and Workshop cards: export user data with security attributes (card data download function),
- Control card: export user data without security attributes except cardholder identification data.

Authentication of a vehicle unit shall be performed by means of proving that it possesses security data that only the system could distribute.

**Selection** (FIA\_UAU.3.1 and FIA\_UAU.3.2): prevent.

**Assignment** (FIA\_UAU.4.1) *Identified authentication mechanism(s):* any authentication mechanism.

The Workshop card shall provide an additional authentication mechanism by checking a PIN code (This mechanism is intended for the vehicle unit to ensure the identity of the card holder, it is not intended to protect workshop card content).

#### 4.2.3. Authentication failures

[<sup>F22</sup>Additionally the following assignments describe the card reaction for each single user authentication failure.

**Assignment** (FIA\_AFL.1.1) *Number: 1, list of authentication events:* authentication of a card interface device.

**Assignment** (FIA\_AFL.1.2) *List of actions:*

- warn the entity connected,
- assume the user as NON\_VEHICLE\_UNIT.

Additionally the following assignments] describe the card reaction in the case of failure of the additional authentication mechanism required in UIA\_302.

**Assignment** (FIA\_AFL.1.1) *Number: 5, list of authentication events:* PIN checks (workshop card).

**Assignment** (FIA\_AFL.1.2) *List of actions:*

- warn the entity connected,
- block the PIN check procedure such that any subsequent PIN check attempt will fail,
- be able to indicate to subsequent users the reason of the blocking.

#### 4.3. Access control

##### 4.3.1. Access control policy

During end-usage phase of its life cycle, the tachograph card is the subject of one single access control security function policy (SFP) named AC\_SFP.

**Assignment** (FDP\_ACC.2.1) *Access control SFP:* AC\_SFP.

##### 4.3.2. Access control functions

**Assignment** (FDP\_ACF.1.1) *Access control SFP:* AC\_SFP.

**Assignment** (FDP\_ACF.1.1) *Named group of security attributes:* USER\_GROUP.

**Assignment** (FDP\_ACF.1.2) *Rules governing access among controlled subjects and controlled objects using controlled operations on controlled objects:*



- [<sup>F22</sup>GENERAL\_READ User data may be read from the TOE by any user, except cardholder identification data which may be read from control cards and company cards by VEHICLE\_UNIT only.]
- IDENTIF\_WRITE : Identification data may only be written once and before the end of phase 6 of card's life-cycle. No user may write or modify identification data during end-usage phase of card's life-cycle.
- ACTIVITY\_WRITE: Activity data may be written to the TOE by VEHICLE\_UNIT only.
- SOFT\_UPGRADE : No user may upgrade TOE's software.
- FILE\_STRUCTURE: Files structure and access conditions shall be created before end of phase 6 of TOE's life-cycle and then locked from any future modification or deletion by any user.

#### 4.4. Accountability

The TOE shall hold permanent identification data.

There shall be an indication of the time and date of the TOE's personalisation. This indication shall remain unalterable.

#### 4.5. Audit

The TOE must monitor events that indicate a potential violation of its security.

**Assignment** (FAU\_SAA.1.2) Subset of defined auditable events:

- cardholder authentication failure (5 consecutive unsuccessful PIN checks),
- self test error,
- stored data integrity error,
- activity data input integrity error.

#### 4.6. Accuracy

##### 4.6.1. Stored data integrity

**Assignment** (FDP\_SDI.2.2) *Actions to be taken*: warn the entity connected,

##### 4.6.2. Basic data authentication

**Assignment** (FDP\_DAU.1.1) *List of objects or information types*: activity data.

**Assignment** (FDP\_DAU.1.2) *List of subjects*: any.

#### 4.7. Reliability of service

##### 4.7.1. Tests

**Selection** (FPT\_TST.1.1): during initial start-up, periodically during normal operation.

Note: during initial start-up means before code is executed (and not necessarily during Answer To Reset procedure).

The TOE's self tests shall include the verification of the integrity of any software code not stored in ROM.

Upon detection of a self test error the TSF shall warn the entity connected.

After OS testing is completed, all testing-specific commands and actions shall be disabled or removed. It shall not be possible to override these controls and restore them for use. Command associated exclusively with one life cycle state shall never be accessed during another state.

---

*Changes to legislation: There are currently no known outstanding effects for the Council Regulation (EEC) No 3821/85. (See end of Document for details)*

---

#### 4.7.2. Software

There shall be no way to analyse, debug or modify TOE's software in the field.

Inputs from external sources shall not be accepted as executable code.

#### 4.7.3. Power supply

The TOE shall preserve a secure state during power supply cut-off or variations.

#### 4.7.4. Reset conditions

If power is cut (or if power variations occur) from the TOE, or if a transaction is stopped before completion, or on any other reset conditions, the TOE shall be reset cleanly.

#### 4.8. Data exchange

##### 4.8.1. Data exchange with a vehicle unit

The TOE shall verify the integrity and authenticity of data imported from a vehicle unit.

Upon detection of an imported data integrity error, the TOE shall:

- warn the entity sending the data,
- not use the data.

The TOE shall export user data to the vehicle unit with associated security attributes, such that the vehicle unit will be able to verify the integrity and authenticity of data received.

##### 4.8.2. Export of data to a non-vehicle unit (download function)

The TOE shall be able to generate an evidence of origin for data downloaded to external media.

The TOE shall be able to provide a capability to verify the evidence of origin of downloaded data to the recipient.

The TOE shall be able to download data to external storage media with associated security attributes such that downloaded data integrity can be verified.

#### 4.9. Cryptographic support

If the TSF generates cryptographic keys, it shall be in accordance with specified cryptographic key generation algorithms and specified cryptographic key sizes. Generated cryptographic session keys shall have a limited (TBD by manufacturer and not more than 240) number of possible use.

If the TSF distributes cryptographic keys, it shall be in accordance with specified cryptographic key distribution methods.

#### 5. Definition of security mechanisms

Required security mechanisms are specified in Appendix 11.

All other security mechanisms are to be defined by the TOE manufacturer.

#### 6. Claimed minimum strength of mechanisms

The minimum strength of mechanisms for the Tachograph Card is *High* as defined in (ITSEC).

#### 7. Level of Assurance





## Appendix 11

### COMMON SECURITY MECHANISMS

#### 1. GENERALITIES

This appendix specifies the security mechanisms ensuring:

- the mutual authentication between VUs and tachograph cards, including session key agreement,
- the confidentiality, integrity and authentication of data transferred between VUs and tachograph cards,
- the integrity and authentication of data downloaded from VUs to external storage media,
- the integrity and authentication of data downloaded from tachograph cards to external storage media.

##### 1.1. References

The following references are used in this Appendix:

SHA-1	National Institute of Standards and Technology (NIST). FIPS Publication 180-1: Secure Hash Standard. April 1995
PKCS1	RSA Laboratories. PKCS # 1: RSA Encryption Standard. Version 2.0. October 1998
TDES	National Institute of Standards and Technology (NIST). FIPS Publication 46-3: Data Encryption Standard. Draft 1999
TDES-OP	ANSI X9.52, Triple Data Encryption Algorithm Modes of Operation. 1998
ISO/IEC 7816-4	Information Technology — Identification cards — Integrated circuit(s) cards with contacts — Part 4: Interindustry commands for interexchange. First edition: 1995 + Amendment 1: 1997
ISO/IEC 7816-6	Information Technology — Identification cards — Integrated circuit(s) cards with contacts — Part 6: Interindustry data elements. First edition: 1996 + Cor 1: 1998
ISO/IEC 7816-8	Information Technology — Identification cards — Integrated circuit(s) cards with contacts — Part 8: Security related interindustry commands. First edition 1999
ISO/IEC 9796-2	Information Technology — Security techniques — Digital signature schemes giving message recovery — Part 2: Mechanisms using a hash function. First edition: 1997
ISO/IEC 9798-3	Information Technology — Security techniques — Entity authentication mechanisms — Part 3: Entity authentication using a public key algorithm. Second edition 1998
ISO 16844-3	Road vehicles — Tachograph systems — Part 3: Motion sensor interface.

##### 1.2. Notations and abbreviated terms

The following notations and abbreviated terms are used in this Appendix:

(K <sub>a</sub> , K <sub>b</sub> , K <sub>c</sub> )	a key bundle for use by the triple data encryption algorithm
CA	Certification authority
CAR	Certification authority reference
CC	Cryptographic checksum

---

*Changes to legislation: There are currently no known outstanding effects for the Council Regulation (EEC) No 3821/85. (See end of Document for details)*

---

CG	Cryptogram
CH	Command header
CHA	Certificate holder authorisation
CHR	Certificate holder reference
D()	Decryption with DES
DE	Data element
DO	Data object
<i>d</i>	RSA private key, private exponent
<i>e</i>	RSA public key, public exponent
E()	Encryption with DES
EQT	Equipment
<i>Hash()</i>	hash value, an output of <i>hash</i>
<i>Hash</i>	hash function
KID	Key identifier
Km	TDES key. Master Key defined in ISO 16844-3
Km <sub>vu</sub>	TDES key inserted in vehicle units
Km <sub>wc</sub>	TDES key inserted in workshop cards
<i>m</i>	message representative an integer between 0 and <i>n</i> -1
<i>n</i>	RSA keys, modulus
PB	Padding bytes
PI	Padding indicator byte (for use in cryptogram for confidentiality DO)
PV	Plain value
<i>s</i>	signature representative, an integer between 0 and <i>n</i> -1
SSC	Send sequence counter
SM	Secure messaging
TCBC	TDEA cipher block chaining mode of operation
TDEA	Triple data encryption algorithm
TLV	Tag length value
VU	Vehicle unit
X.C	the certificate of user X issued by a certification authority
X.CA	a certification authority of user X
X.CA.PK <sub>o</sub> X.C	the operation of unwrapping a certificate to extract a public key. It is an infix operator, whose left operand is the public key of a certification authority, and whose right operand is the certificate issued by that certification authority. The outcome is the public key of the user X whose certificate is the right operand,
X.PK	public key of a user X
X.PK[I]	RSA encipherment of some information I, using the public key of user X
X.SK	RSA private key of a user X
X.SK[I]	RSA encipherment of some information I, using the private key of user X
'xx'	a Hexadecimal value
	concatenation operator.

## 2. CRYPTOGRAPHIC SYSTEMS AND ALGORITHMS

### 2.1. Cryptographic systems

Vehicle units and tachograph cards shall use a classical RSA public-key cryptographic system to provide the following security mechanisms:

- authentication between vehicle units and cards,
- transport of Triple-DES session keys between vehicle units and tachograph cards,

---

**Changes to legislation:** There are currently no known outstanding effects for the Council Regulation (EEC) No 3821/85. (See end of Document for details)

---

- digital signature of data downloaded from vehicle units or tachograph cards to external media.

Vehicle units and tachograph cards shall use a Triple DES symmetric cryptographic system to provide a mechanism for data integrity during user data exchange between vehicle units and tachograph cards, and to provide, where applicable, confidentiality of data exchange between vehicle units and tachograph cards.

## 2.2. Cryptographic algorithms

### 2.2.1. RSA algorithm

The RSA algorithm is fully defined by the following relations:

$$X.SK[m] = s = m^d \bmod n$$

$$X.PK[s] = m = s^e \bmod n$$

A more comprehensive description of the RSA function can be found in reference (PKCS1).

[<sup>F22</sup>Public exponent, e, for RSA calculations is an integer between 3 and n-1 satisfying  $\gcd(e, \text{lcm}(p-1, q-1))=1$ .]

### 2.2.2. Hash algorithm

The digital signature mechanisms shall use the SHA-1 hash algorithm as defined in reference (SHA-1).

### 2.2.3. Data encryption algorithm

DES based algorithms shall be used in Cipher Block Chaining mode of operation.

## 3. KEYS AND CERTIFICATES

### 3.1. Keys generation and distribution

#### 3.1.1. RSA keys generation and distribution

RSA keys shall be generated through three functional hierarchical levels:

- European level,
- Member State level,
- Equipment level.

At European level, a single European key pair (EUR.SK and EUR.PK) shall be generated. The European private key shall be used to certify the Member States public keys. Records of all certified keys shall be kept. These tasks shall be handled by a European certification authority, under the authority and responsibility of the European Commission.

At Member State level, a Member State key pair (MS.SK and MS.PK) shall be generated. Member States public keys shall be certified by the European Certification Authority. The Member State private key shall be used to certify public keys to be inserted in equipment (vehicle unit or tachograph card). Records of all certified public keys shall be kept with the identification of the equipment to which it is intended. These tasks shall be handled by a Member State certification authority. A Member State may regularly change its key pair.

---

**Changes to legislation:** There are currently no known outstanding effects for the Council Regulation (EEC) No 3821/85. (See end of Document for details)

---

At equipment level, one single key pair (EQT.SK and EQT.PK) shall be generated and inserted in each equipment. Equipment public keys shall be certified by a Member State certification authority. These tasks may be handled by equipment manufacturers, equipment personalisers or Member State authorities. This key pair is used for authentication, digital signature and encipherment services

Private keys confidentiality shall be maintained during generation, transport (if any) and storage.

The following picture summarises the data flow of this process:



*Changes to legislation: There are currently no known outstanding effects for the Council Regulation (EEC) No 3821/85. (See end of Document for details)*

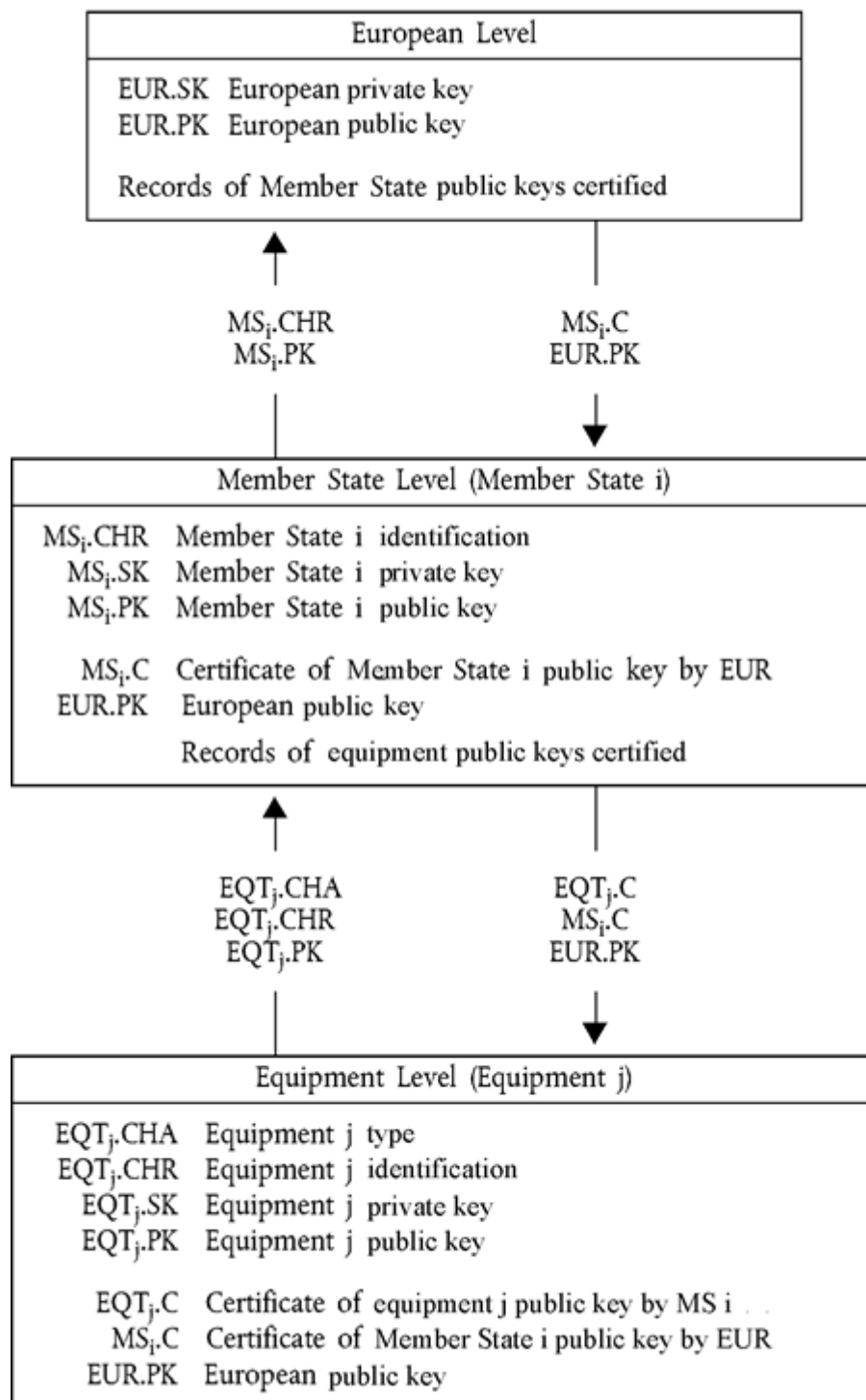

3.1.2. RSA test keys

---

**Changes to legislation:** There are currently no known outstanding effects for the Council Regulation (EEC) No 3821/85. (See end of Document for details)

---

For the purpose of equipment testing (including interoperability tests) the European certification authority shall generate a different single European test key pair and at least two Member State test key pairs, the public keys of which shall be certified with the European private test key. Manufacturers shall insert, in equipment undergoing type approval tests, test keys certified by one of these Member State test keys.

### 3.1.3. Motion sensor keys

The confidentiality of the three TDES keys described below shall be appropriately maintained during generation, transport (if any) and storage.

In order to support recording equipment compliant with ISO 16844, the European certification authority and the Member State certification authorities shall, in addition, ensure the following:

The European certification authority shall generate  $K_{m_{VU}}$  and  $K_{m_{WC}}$ , two independent and unique Triple DES keys, and generate  $K_m$  as:

$$K_m = K_{m_{VU}} \text{ XOR } K_{m_{WC}}$$

The European certification authority shall forward these keys, under appropriately secured procedures, to Member States certification authorities at their request.

Member States certification authorities shall:

- use  $K_m$  to encrypt motion sensor data requested by motion sensor manufacturers (data to be encrypted with  $K_m$  is defined in ISO 16844-3),
- forward  $K_{m_{VU}}$  to vehicle unit manufacturers, under appropriately secured procedures, for insertion in vehicle units,
- ensure that  $K_{m_{WC}}$  will be inserted in all workshop cards (*SensorInstallationSecData* in *Sensor\_Installation\_Data* elementary file) during card personalisation.

### 3.1.4. T-DES session keys generation and distribution

Vehicle units and tachograph cards shall, as a part of the mutual authentication process, generate and exchange necessary data to elaborate a common Triple DES session key. This exchange of data shall be protected for confidentiality through an RSA crypt-mechanism.

This key shall be used for all subsequent cryptographic operations using secure messaging. Its validity shall expire at the end of the session (withdrawal of the card or reset of the card) and/or after 240 use (one use of the key = one command using secure messaging sent to the card and associated response).

## 3.2. Keys

RSA keys shall have (whatever the level) the following lengths: modulus  $n$  1024 bits, public exponent  $e$  64 bits maximum, private exponent  $d$  1024 bits.

Triple DES keys shall have the form  $(K_a, K_b, K_a)$  where  $K_a$  and  $K_b$  are independent 64 bits long keys. No parity error detecting bits shall be set.

## 3.3. Certificates

RSA Public key certificates shall be 'non self-descriptive' 'Card Verifiable' certificates (Ref.: ISO/IEC 7816-8)

**Changes to legislation:** There are currently no known outstanding effects for the Council Regulation (EEC) No 3821/85. (See end of Document for details)

### 3.3.1. Certificates content

RSA Public key certificates are built with the following data in the following order:

Data	Format	Bytes	Obs
CPI	INTEGER	1	Certificate profile identifier ('01' for this version)
CAR	OCTET STRING	8	Certification authority reference
CHA	OCTET STRING	7	Certificate holder authorisation
EOV	TimeReal	4	Certificate end of validity. Optional, 'FF' padded if not used
CHR	OCTET STRING	8	Certificate holder reference
<i>n</i>	OCTET STRING	128	Public key (modulus)
<i>e</i>	OCTET STRING	8	Public key (public exponent)
		164	

Notes:

1. The 'Certificate Profile Identifier' (CPI) delineates the exact structure of an authentication certificate. It can be used as an equipment internal identifier of a relevant headerlist which describes the concatenation of Data Elements within the certificate.

The headerlist associated with this certificate content is as follows:

'4D'	'16'	'5F 29'	'01'	'42'	'08'	'5F 4B'	'07'	'5F 24'	'04'	'5F 20'	'08'	'7F 49'	'05'	'81'	'81 80'	'82'	'08'
Extended headerlist Tag	Length of header list	CPI Tag	CPI Length	CAR Tag	CAR Length	CHA Tag	CHA Length	EOV Tag	EOV Length	CHR Tag	CHR Length	Public key Tag (constructed)	Length of subsequent DOs	modulus Tag	modulus length	public exponent Tag	public exponent length

2. The 'Certification Authority Reference' (CAR) has the purpose of identifying the certificate issuing CA, in such a way that the data element can be used at the same time as an authority key identifier to reference the public key of the certification authority (for coding, see Key Identifier below).

*Changes to legislation: There are currently no known outstanding effects for the Council Regulation (EEC) No 3821/85. (See end of Document for details)*

3. The 'Certificate Holder Authorisation' ((CHA) is used to identify the rights of the certificate holder. It consists of the Tachograph Application ID and of the type of equipment to which the certificate is intended (according to EquipmentType data element, '00' for a Member State).
4. 'Certificate Holder Reference' (CHR) has the purpose of identifying uniquely the certificate holder, in such a way that the Data Element can be used at the same time as a Subject Key Identifier to reference the Public Key of the certificate holder.
5. Key Identifiers uniquely identify certificate holder or certification authorities. They are coded as follows:
  - 5.1. Equipment (VU or Card):

<b>Data</b>	<b>Equipment serial number</b>	<b>Date</b>	<b>Type</b>	<b>Manufacturer</b>
<b>Length</b>	4 Bytes	2 Bytes	1 Byte	1 Byte
<b>Value</b>	Integer	mm yy BCD coding	Manufacturer specific	Manufacturer code

In the case of a VU, the manufacturer, when requesting certificates, may or may not know the identification of the equipment in which the keys will be inserted.

In the first case, the manufacturer will send the equipment identification with the public key to its Member State authority for certification. The certificate will then contain the equipment identification, and the manufacturer must ensure that keys and certificate are inserted in the intended equipment. The Key identifier has the form shown above.

In the later case, the manufacturer must uniquely identify each certificate request and send this identification with the public key to its Member State authority for certification. The certificate will contain the request identification. The manufacturer must feed back its Member State authority with the assignment of key to equipment (i.e. certificate request identification, equipment identification) after key installation in the equipment. The key identifier has the following form:

<b>Data</b>	<b>Certificate request serial number</b>	<b>Date</b>	<b>Type</b>	<b>Manufacturer</b>
<b>Length</b>	4 Bytes	2 Bytes	1 Byte	1 Byte
<b>Value</b>	[ <sup>F22</sup> Integer]	[ <sup>X1</sup> mm yy BCD coding]	'FF'	Manufacturer code

- 5.2. Certification Authority:

<b>Data</b>	<b>Authority identification</b>	<b>Key serial number</b>	<b>Additional info</b>	<b>Identifier</b>
<b>Length</b>	4 Bytes	1 Byte	2 Bytes	1 Byte

**Changes to legislation:** There are currently no known outstanding effects for the Council Regulation (EEC) No 3821/85. (See end of Document for details)

<b>Value</b>	1 Byte nation numerical code	Integer	additional coding (CA specific)	'01'
	3 Bytes nation alphanumeric code		'FF FF' if not used	

The key serial number is used to distinguish the different keys of a Member State, in the case the key is changed.

6. Certificate verifiers shall implicitly know that the public key certified is an RSA key relevant to authentication, digital signature verification and encipherment for confidentiality services (the certificate contains no Object Identifier to specify it).

### 3.3.2. Certificates issued

The certificate issued is a digital signature with partial recovery of the certificate content in accordance with ISO/IEC 9796-2 [F24] except for its Annex A.4], with the 'Certification Authority Reference' appended.

$$X.C = X.CA.SK['6A' || C_r || Hash(Cc) || 'BC'] || C_n || X.CAR$$

With certificate content

$$= Cc = \begin{matrix} C_r \\ 106 \text{ Bytes} \end{matrix} || \begin{matrix} C_n \\ 58 \text{ Bytes} \end{matrix}$$

Notes:

1. This certificate is 194 bytes long.
2. CAR, being hidden by the signature, is also appended to the signature, such that the public key of the certification authority may be selected for the verification of the certificate.
3. The certificate verifier shall implicitly know the algorithm used by the certification authority to sign the certificate.
4. The headerlist associated with this issued certificate is as follows:

*Changes to legislation: There are currently no known outstanding effects for the Council Regulation (EEC) No 3821/85. (See end of Document for details)*

'7F 21'	'09'	'5F 37'	'81 80'	'5F 38'	'3A'	'42'	'08'
CV Certificate Tag (Constructed)	Length of subsequent DOs	Signature Tag	Signature length	Remainder Tag	Remainder length	CAR Tag	CAR length

### 3.3.3. Certificate verification and unwrapping

Certificate verification and unwrapping consists in verifying the signature in accordance with ISO/IEC 9796-2, retrieving the certificate content and the public key contained: X.PK = X.CA.PK<sub>0</sub>X.C, and verifying the validity of the certificate.

It involves the following steps:

verify signature and retrieve content:

- from X.C retrieve Sign, C<sub>n</sub>' and CAR':
- from CAR' select appropriate Certification Authority Public Key (if not done before through other means)
- open Sign with CA Public Key: Sr' = X.CA.PK [Sign],
- check Sr' starts with '6A' and ends with 'BC'
- compute Cr' and H' from:
- Recover certificate content C' = Cr' || C<sub>n</sub>'
- check Hash(C') = H'

If the checks are OK the certificate is a genuine one, its content is C'.

Verify validity. From C':

- if applicable, check End of validity date,
- Retrieve and store public key, Key Identifier, Certificate Holder Authorisation and Certificate End of Validity from C':
- X.PK = n || e
  - X.KID = CHR
  - X.CHA = CHA
  - X.EOV = EOVS.

## 4. MUTUAL AUTHENTICATION MECHANISM

Mutual authentication between cards and VUs is based on the following principle:

Each party shall demonstrate to the other that it owns a valid key pair, the public key of which has been certified by a Member State certification authority, itself being certified by the European certification authority.

---

**Changes to legislation:** There are currently no known outstanding effects for the Council Regulation (EEC) No 3821/85. (See end of Document for details)

---

Demonstration is made by signing with the private key a random number sent by the other party, who must recover the random number sent when verifying this signature.

The mechanism is triggered at card insertion by the VU. It starts with the exchange of certificates and unwrapping of public keys, and ends with the setting of a session key.

The following protocol shall be used (arrows indicate commands and data exchanged (see Appendix 2)):

*Changes to legislation: There are currently no known outstanding effects for the Council Regulation (EEC) No 3821/85. (See end of Document for details)*

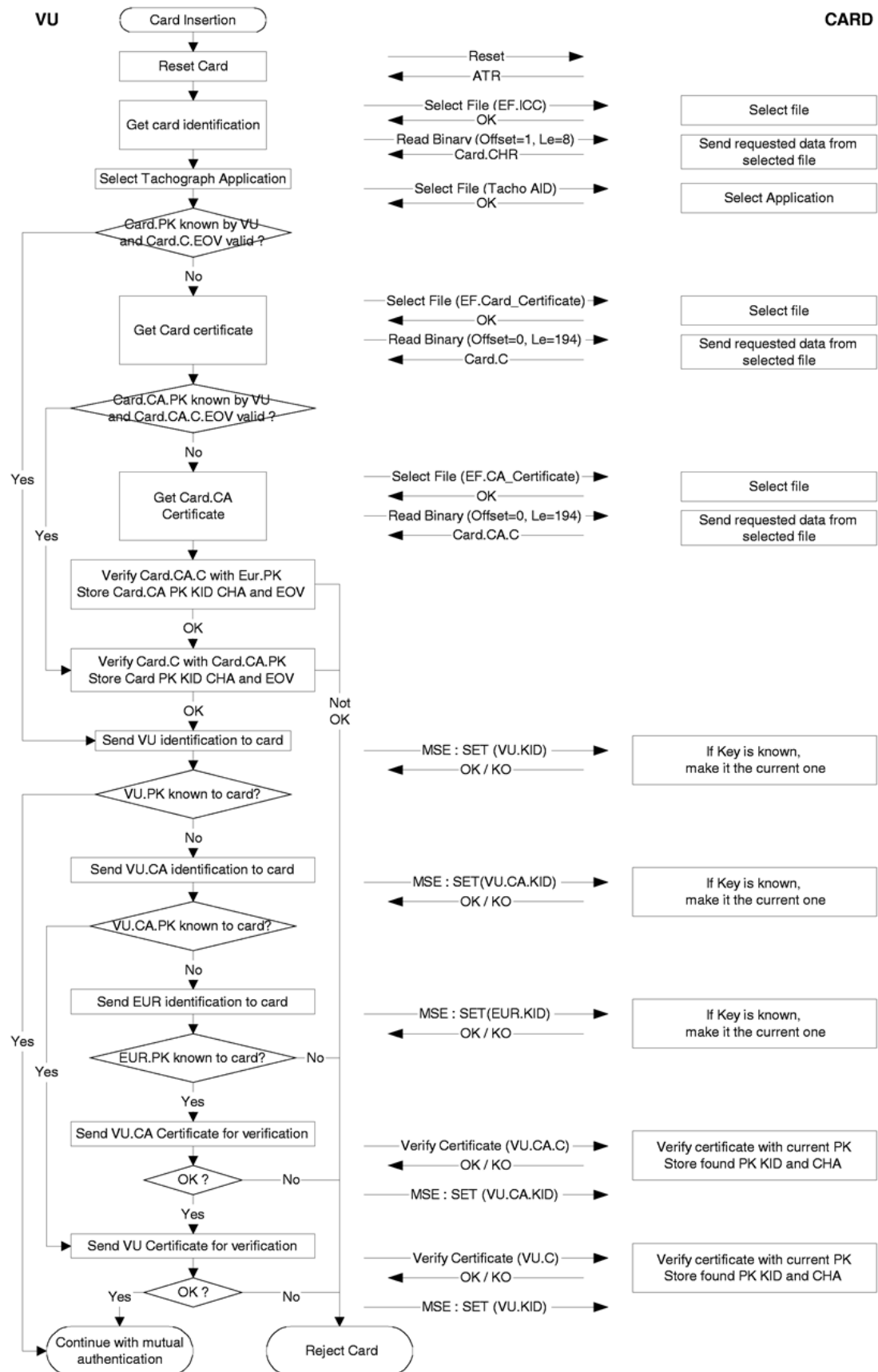



**Changes to legislation:** There are currently no known outstanding effects for the Council Regulation (EEC) No 3821/85. (See end of Document for details)

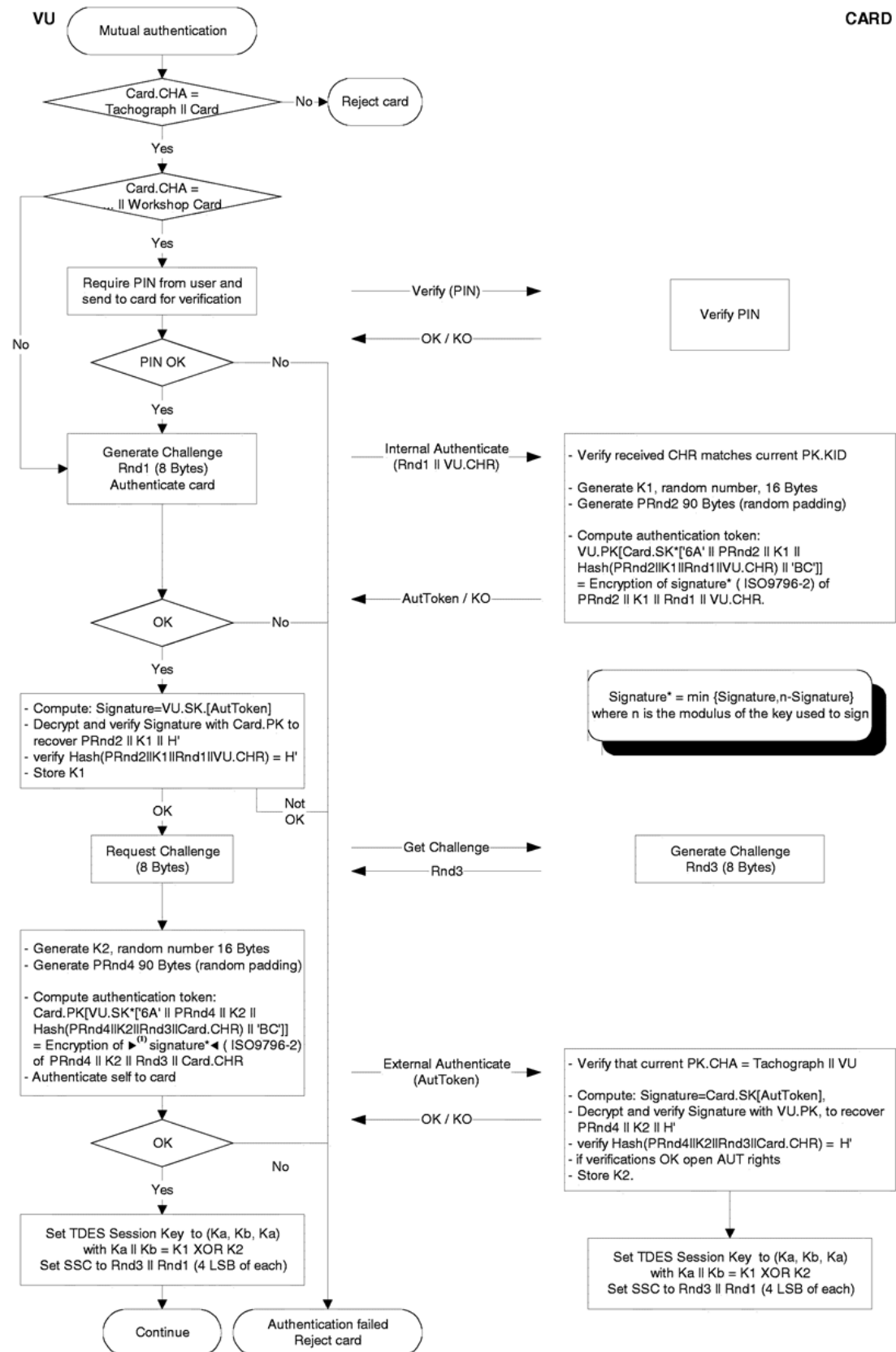

*Changes to legislation: There are currently no known outstanding effects for the Council Regulation (EEC) No 3821/85. (See end of Document for details)*

## 5. VU-CARDS DATA TRANSFER CONFIDENTIALITY, INTEGRITY AND AUTHENTICATION MECHANISMS

### 5.1. Secure messaging

VU-cards data transfers integrity shall be protected through Secure Messaging in accordance with references (ISO/IEC 7816-4) and (ISO/IEC 7816-8).

When data need to be protected during transfer, a cryptographic checksum data object shall be appended to the data objects sent within the command or the response. The cryptographic checksum shall be verified by the receiver.

The cryptographic checksum of data sent within a command shall integrate the command header, and all data objects sent ( $= > \text{CLA} = '0C'$ , and all data objects shall be encapsulated with tags in which  $b_1 = 1$ ).

The response status-information bytes shall be protected by a cryptographic checksum when the response contains no data field.

Cryptographic checksums shall be four bytes long.

The structure of commands and responses when using secure messaging is therefore the following:

The DOs used are a partial set of the Secure Messaging DOs described in ISO/IEC 7816-4:

Tag	Mnemonic	Meaning
'81'	T <sub>PV</sub>	Plain Value not BER-TLV coded data (to be protected by CC)
'97'	T <sub>LE</sub>	Value of Le in the unsecured command (to be protected by CC)
'99'	T <sub>SW</sub>	Status-Info (to be protected by CC)
'8E'	T <sub>CC</sub>	Cryptographic Checksum
'87'	T <sub>PI CG</sub>	Padding Indicator Byte    Cryptogram (Plain Value not coded in BER-TLV)

Given an unsecured command response pair:

Command header		Command body	
CLA INS P1 P2		(L <sub>c</sub> -field) (Data field) (L <sub>e</sub> -field)	
four bytes		L bytes, denoted as B <sub>1</sub> to B <sub>L</sub>	
Response body		Response trailer	
(Data field)		SW1	SW2
L <sub>r</sub> data bytes		two bytes	

**Changes to legislation:** There are currently no known outstanding effects for the Council Regulation (EEC) No 3821/85. (See end of Document for details)

The corresponding secured command response pair is:

Secured command:

Command body											
header											
(CH)											
CLA	(New L <sub>c</sub> field)	(New Data field)								(New L <sub>e</sub> field)	
INS											
P1											
P2											
'OC'	Length of new data field	T <sub>PV</sub>	L <sub>PV</sub>	PV	T <sub>LE</sub>	L <sub>LE</sub>	L <sub>e</sub>	T <sub>CC</sub>	L <sub>CC</sub>	CC	'00'
		'81'	L <sub>c</sub>	Data field	'97'	'01'	L <sub>e</sub>	'8E'	'04'	CC	

Data to be integrated in checksum = CH || PB || T<sub>PV</sub> || L<sub>PV</sub> || PV || T<sub>LE</sub> || L<sub>LE</sub> || L<sub>e</sub> || PB

[<sup>X1</sup>PB = padding bytes (80..00) in accordance with ISO-IEC 7816-4 and ISO 9797 method 2]

DOs PV and LE are present only when there is some corresponding data in the unsecured command.

Secured response:

1. Case where response data field is not empty and needs not to be protected for confidentiality:

Response body						Response trailer
(New data field)						new SW1 SW2
T <sub>PV</sub>	L <sub>PV</sub>	PV	T <sub>CC</sub>	L <sub>CC</sub>	CC	
'81'	L <sub>r</sub>	Data field	'8E'	'04'	CC	

Data to be integrated in checksum = T<sub>PV</sub> || L<sub>PV</sub> || PV || PB

2. Case where response data field is not empty and needs to be protected for confidentiality:

Response body						Response trailer
(New data field)						new SW1 SW2
T <sub>PI CG</sub>	L <sub>PI CG</sub>	PI CG	T <sub>CC</sub>	L <sub>CC</sub>	CC	

**Changes to legislation:** There are currently no known outstanding effects for the Council Regulation (EEC) No 3821/85. (See end of Document for details)

'87'		PI    CG	'8E'	'04'	CC	
------	--	-------------	------	------	----	--

Data to be carried by CG: non BER-TLV coded data and padding bytes.

Data to be integrated in checksum =  $T_{PI\ CG} || L_{PI\ CG} || PI\ CG\ PB$

3. Case where response data field is empty:

Response body						Response trailer
(New data field)						new SW1 SW2
$T_{SW}$	$L_{SW}$	SW	$T_{CC}$	$L_{CC}$	CC	
'99'	'02'	New SW1 SW2	'8E'	'04'	CC	

Data to be integrated in checksum =  $T_{SW} || L_{SW} || SW || PB$

5.2. Treatment of secure messaging errors

When the tachograph card recognises an SM error while interpreting a command, then the status bytes must be returned without SM. In accordance with ISO/IEC 7816-4, the following status bytes are defined to indicate SM errors:

'66 88' : verification of cryptographic checksum failed,  
 '69 87' : expected SM data objects missing,  
 '69 88' : SM data objects incorrect.

When the tachograph card returns status bytes without SM DOs or with an erroneous SM DO, the session must be aborted by the VU.

5.3. Algorithm to compute cryptographic checksums

Cryptographic checksums are built using a retail MACs in accordance with ANSI X9.19 with DES:

- initial stage: the initial check block  $y_0$  is  $E(K_a, SSC)$ .
- sequential stage: the check blocks  $y_1, \dots, y_n$  are calculated using  $K_a$ .
- final stage: the cryptographic checksum is calculated from the last check block  $y_n$  as follows:  $E(K_a, D(K_b, y_n))$ .

where  $E()$  means encryption with DES, and  $D()$  means decryption with DES.

The four most significant bytes of the cryptographic checksum are transferred

The send sequence counter (SSC) shall be initiated during key agreement procedure to:

Initial SSC:  $Rnd3$  (4 least significant bytes) ||  $Rnd1$  (4 least significant bytes).

The send sequence counter shall be increased by 1 each time before a MAC is calculated (i.e. the SSC for the first command is Initial SSC + 1, the SSC for the first response is Initial SSC + 2).

*Changes to legislation: There are currently no known outstanding effects for the Council Regulation (EEC) No 3821/85. (See end of Document for details)*

The following figure shows the calculation of the retail MAC:

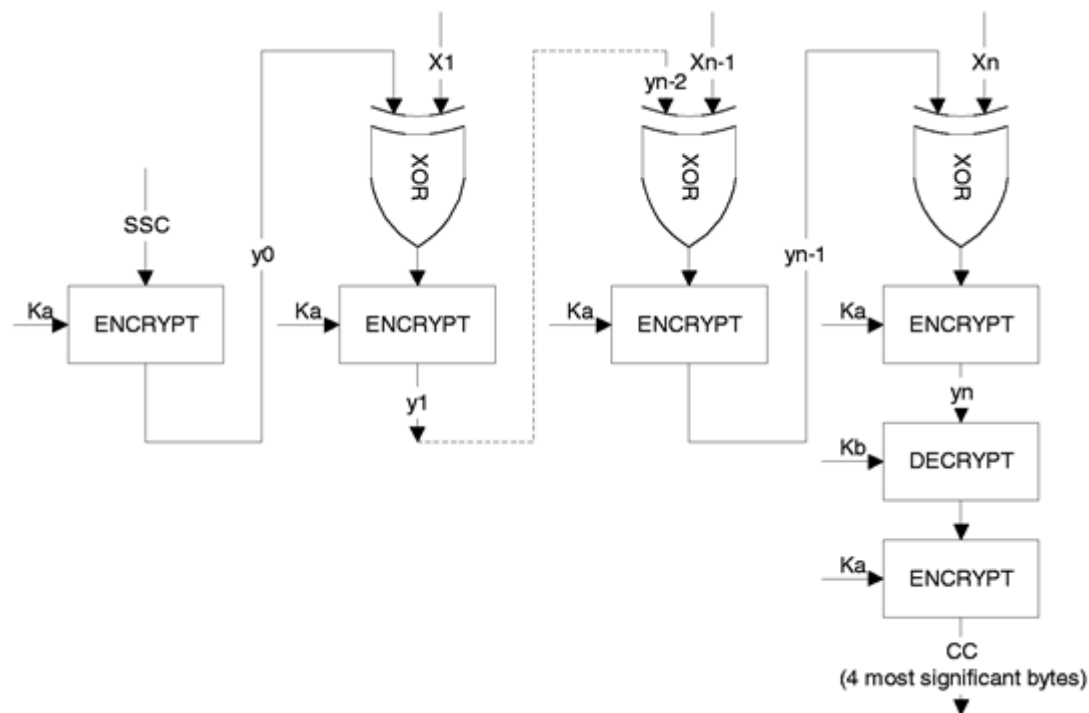

#### 5.4. Algorithm to compute cryptograms for confidentiality DOs

Cryptograms are computed using TDEA in TCBC mode of operation in accordance with references (TDES) and (TDES-OP) and with the Null vector as Initial Value block.

The following figure shows the application of keys in TDES:

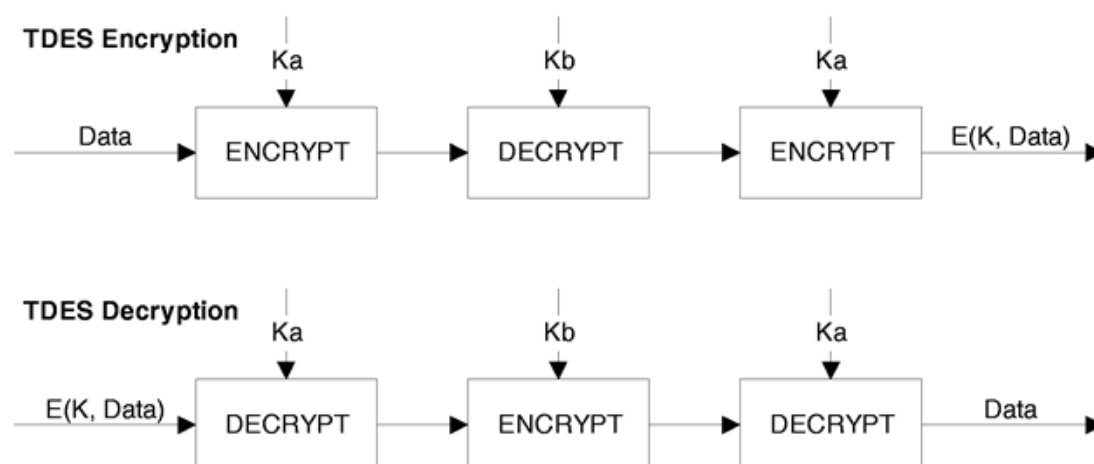

## 6. DATA DOWNLOAD DIGITAL SIGNATURE MECHANISMS

The intelligent dedicated equipment (IDE) stores data received from an equipment (VU or card) during one download session within one physical data file. This file must contain the certificates

---

**Changes to legislation:** There are currently no known outstanding effects for the Council Regulation (EEC) No 3821/85. (See end of Document for details)

---

MS<sub>i</sub>.C and EQT.C. The file contains digital signatures of data blocks as specified in Appendix 7 Data Downloading Protocols.

Digital signatures of downloaded data shall use a digital signature scheme with appendix such, that downloaded data may be read without any decipherment if desired.

#### 6.1. Signature generation

Data signature generation by the equipment shall follow the signature scheme with appendix defined in reference (PKCS1) with the SHA-1 hash function:

$$\text{Signature} = \text{EQT.SK}[\text{'00'} \parallel \text{'01'} \parallel \text{PS} \parallel \text{'00'} \parallel \text{DER}(\text{SHA-1}(\text{Data}))]$$

PS = Padding string of octets with value 'FF' such that length is 128.

DER(SHA-1(*M*)) is the encoding of the algorithm ID for the hash function and the hash value into an ASN.1 value of type *DigestInfo* (distinguished encoding rules):

$$\text{'30'} \parallel \text{'21'} \parallel \text{'30'} \parallel \text{'09'} \parallel \text{'06'} \parallel \text{'05'} \parallel \text{'2B'} \parallel \text{'0E'} \parallel \text{'03'} \parallel \text{'02'} \parallel \text{'1A'} \parallel \text{'05'} \parallel \text{'00'} \parallel \text{'04'} \parallel \text{'14'} \parallel \text{Hash Value.}$$

#### 6.2. Signature verification

Data signature verification on downloaded data shall follow the signature scheme with appendix defined in reference (PKCS1) with the SHA-1 hash function.

The European public key EUR.PK needs to be known independently (and trusted) by the verifier.

The following table illustrates the protocol an IDE carrying a Control card can follow to verify the integrity of data downloaded and stored on the ESM (external storage media). The control card is used to perform the decipherment of digital signatures. This function may in this case not be implemented in the IDE.

The equipment that has downloaded and signed the data to be analysed is denoted EQT.

**Changes to legislation:** There are currently no known outstanding effects for the Council Regulation (EEC) No 3821/85. (See end of Document for details)

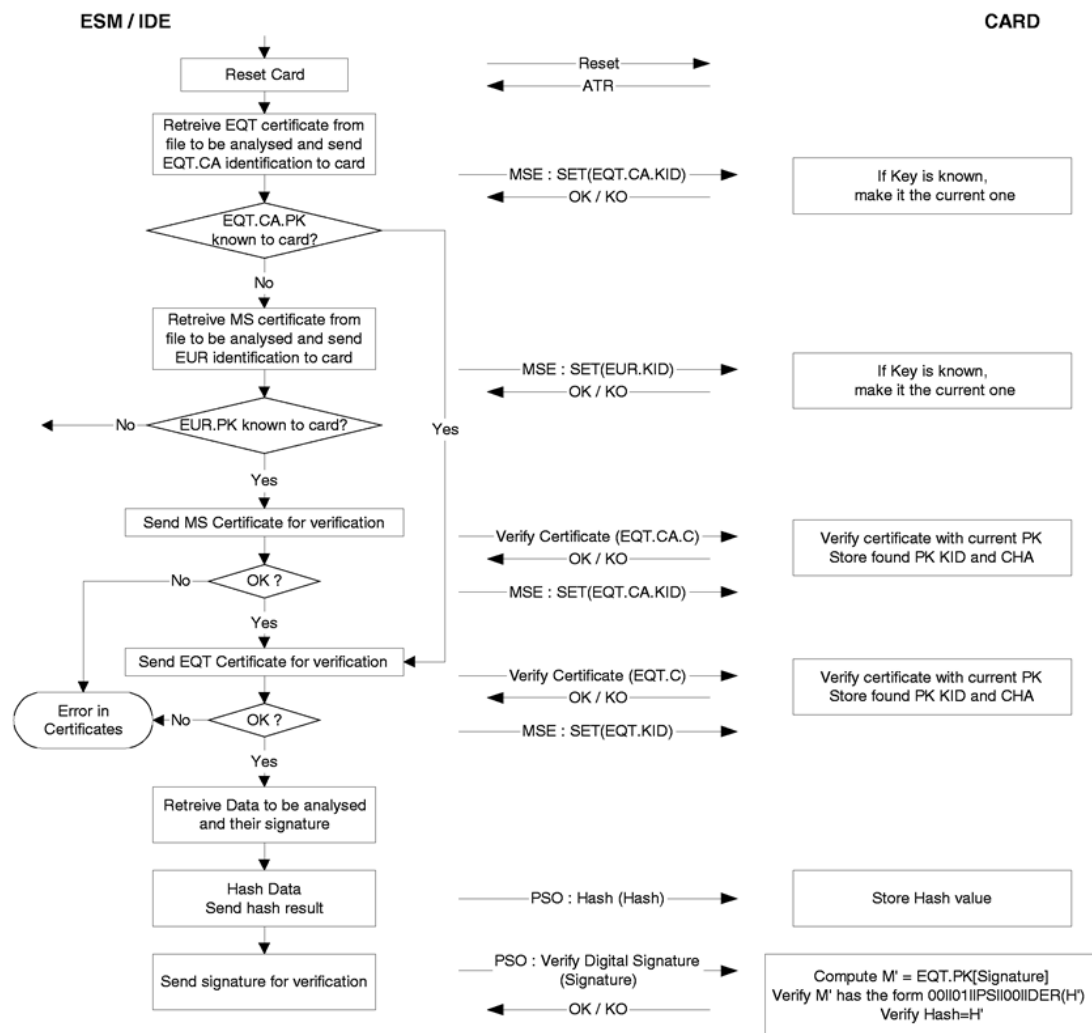

---

*Changes to legislation: There are currently no known outstanding effects for the Council Regulation (EEC) No 3821/85. (See end of Document for details)*

---

## [<sup>F16</sup>Appendix 12

### ADAPTOR FOR M 1 AND N1 CATEGORY VEHICLES

#### 1. ABBREVIATIONS AND REFERENCE DOCUMENTS

##### 1.1. Abbreviations

TBD                      To Be Defined  
 VU                        Vehicle Unit

##### 1.2. Reference standards

*ISO 16844-3 Road vehicles – Tachograph systems – Part 3: Motion sensor interface*

#### 2. GENERAL CHARACTERISTICS AND FUNCTIONS OF THE ADAPTOR

##### 2.1. Adaptor general description

ADA\_001                The adaptor shall provide a connected VU with secured motion data permanently representative of vehicle speed and distance travelled.

The adaptor is only intended for those vehicles that are required to be equipped with recording equipment in compliance with this Regulation.

It shall be installed and used only in those types of vehicle defined under (rr), where it is not mechanically possible to install any other type of existing motion sensor which is otherwise compliant with the provisions of this Annex and its Appendixes 1 to 11.

The adaptor shall not be mechanically interfaced to a moving part of the vehicle, as required by Appendix 10 of this Annex (section 3.1), but connected to the speed/distance impulses which are generated by integrated sensors or alternative interfaces.

ADA\_002                A type approved motion sensor (according to the provisions of this Annex, section VIII - Type approval of recording equipment and tachograph cards) shall be fitted into the adaptor housing, which shall also include a pulse converter device inducing the incoming pulses to the embedded motion sensor. The embedded motion sensor itself shall be connected to the VU, so that the interface between the VU and the adaptor shall be compliant with the requirements set out in ISO 16844-3.

##### 2.2. Functions

ADA\_003                The adaptor shall include the following functions:

- interfacing and adapting the incoming speed pulses,
- inducing the incoming pulses to the embedded motion sensor,
- all functions of the embedded motion sensor, providing secured motion data to the VU.

##### 2.3. Security

ADA\_004                The adaptor shall not be security certified according to the motion sensor generic security target defined in Appendix 10 of this Annex. Security related requirements specified in section 4.4 of this Appendix shall apply instead.



---

**Changes to legislation:** There are currently no known outstanding effects for the Council Regulation (EEC) No 3821/85. (See end of Document for details)

---

### 3. REQUIREMENTS FOR THE RECORDING EQUIPMENT WHEN AN ADAPTOR IS INSTALLED

The requirements in this and the following Chapters indicate how the requirements of this Annex shall be understood when an adaptor is used. The related requirement numbers are provided between brackets.

- ADA\_005 The recording equipment of any vehicle fitted with an adaptor must comply with all the provisions of this Annex, except otherwise specified in this Appendix.
- ADA\_006 When an adaptor is installed, the recording equipment includes cables, the adaptor (instead of a motion sensor), and a VU (001).
- ADA\_007 The detection of events and/or faults function of the recording equipment is modified as follows:
- the ‘power supply interruption’ event shall be triggered by the VU, while not in calibration mode, in case of any interruption exceeding 200 milliseconds of the power supply of the embedded motion sensor (066),
  - any power supply interruption of more than 200 ms (milliseconds) of the adaptor shall generate a power supply interruption of the embedded motion sensor of equivalent length. The adaptor interrupter threshold shall be defined by the adaptor manufacturer,
  - the ‘motion data error’ event shall be triggered by the VU in case of interruption of the normal data flow between the embedded motion sensor and the VU and/or in case of data integrity or data authentication error during data exchange between the embedded motion sensor and the VU (067),
  - the ‘security breach attempt’ event shall be triggered by the VU for any other event affecting the security of the embedded motion sensor, while not in calibration mode (068),
  - the ‘recording equipment’ fault shall be triggered by the VU, while not in calibration mode, for any fault of the embedded motion sensor (070).
- ADA\_008 The adaptor faults detectable by the recording equipment shall be those related with the embedded motion sensor (071).
- ADA\_009 The VU calibration function shall allow to automatically pair the embedded motion sensor with the VU (154, 155).
- ADA\_010 The terms ‘motion sensor’ or ‘sensor’ in the VU Security Target in Appendix 10 of this Annex refer to the embedded motion sensor.

### 4. CONSTRUCTION AND FUNCTIONAL REQUIREMENTS FOR THE ADAPTOR

#### 4.1. Interfacing and adapting incoming speed pulses

- ADA\_011 The adaptor input interface shall accept frequency pulses representative of the vehicle speed and distance travelled. Electrical characteristics of the incoming pulses are: *TBD by the manufacturer*. Adjustments accessible to only the adaptor manufacturer and to the approved workshop performing the adaptor installation shall allow the correct interfacing of the adaptor input to the vehicle, if applicable.
- ADA\_012 The adaptor input interface shall be able, if applicable, to multiply or divide the frequency pulses of the incoming speed pulses by a fixed

---

*Changes to legislation: There are currently no known outstanding effects for the Council Regulation (EEC) No 3821/85. (See end of Document for details)*

---

factor, to adapt the signal to a value in the k factor range defined by this Annex (4 000 to 25 000 pulses/km). This fixed factor may only be programmed by the adaptor manufacturer, and the approved workshop performing the adaptor installation.

#### 4.2. Inducing the incoming pulses to the embedded motion sensor

ADA\_013 The incoming pulses, possibly adapted as specified above, shall be induced to the embedded motion sensor, so that each incoming pulse shall be detected by the motion sensor.

#### 4.3. Embedded motion sensor

ADA\_014 The embedded motion sensor shall be stimulated by the induced pulses, thus allowing it to generate motion data accurately representing the vehicle movement, as if it was mechanically interfaced to a moving part of the vehicle.

ADA\_015 The identification data of the embedded motion sensor shall be used by the VU to identify the adaptor (077).

ADA\_016 The installation data stored in the embedded motion sensor shall be considered to represent the adaptor installation data (099).

#### 4.4. Security requirements

ADA\_017 The adaptor housing shall be designed so that it cannot be opened. It shall be sealed, so that physical tampering attempts can be easily detected (e.g. through visual inspection, see ADA\_035).

ADA\_018 It shall not be possible to remove the embedded motion sensor from the adaptor without breaking the seal(s) of the adaptor housing, or breaking the seal between the sensor and the adaptor housing (see ADA\_035).

ADA\_019 The adaptor shall ensure that motion data may only be processed and derived from the adaptor input.

#### 4.5. Performance characteristics

ADA\_020 The adaptor shall be fully operational in the temperature range (*TBD by the manufacturer, depending on the installation position*) (159).

ADA\_021 The adaptor shall be fully operational in the humidity range 10 % to 90 % (160).

ADA\_022 The adaptor shall be protected against over-voltage, inversion of its power supply polarity, and short circuits (161).

ADA\_023 The adaptor shall conform to Commission Directive 2006/28/EC<sup>(26)</sup> adapting to technical progress Council Directive 72/245/EEC, related to electromagnetic compatibility, and shall be protected against electrostatic discharges and transients (162).

#### 4.6. Materials

ADA\_024 The adaptor shall meet the protection grade (TBD by the manufacturers, depending upon the installation position) (164, 165).

ADA\_025 The colour of the adaptor housing shall be yellow.

#### 4.7. Markings

ADA\_026 A descriptive plaque shall be affixed to the adaptor and shall show the following details (169):

— name and address of the manufacturer of the adaptor,

---

*Changes to legislation: There are currently no known outstanding effects for the Council Regulation (EEC) No 3821/85. (See end of Document for details)*

---

- manufacturer's part number and year of manufacture of the adaptor,
  - approval mark of the adaptor type or of the recording equipment type including the adaptor,
  - the date on which the adaptor has been installed,
  - the vehicle identification number of the vehicle on which it has been installed.
- ADA\_027 The descriptive plaque shall also show the following details (if not directly readable from the outside on the embedded motion sensor):
- name of the manufacturer of the embedded motion sensor,
  - manufacturer's part number and year of manufacture of the embedded motion sensor,
  - approval mark for the embedded motion sensor.
5. INSTALLATION OF THE RECORDING EQUIPMENT WHEN AN ADAPTOR IS USED
- 5.1. Installation
- ADA\_028 Adaptors to be installed in vehicles shall be delivered only to vehicle manufacturers, or to workshops approved by the competent authorities of the Member States and authorised to install, activate and calibrate digital tachographs.
- ADA\_029 Such approved workshop installing the adaptor shall adjust the input interface and select the division ratio of the input signal (if applicable).
- ADA\_030 Such approved workshop installing the adaptor shall seal the adaptor housing.
- ADA\_031 The adaptor shall be fitted as close as possible to that part of the vehicle which provides its incoming pulses.
- ADA\_032 The cables for providing the adaptor power supply shall be red (positive supply) and black (ground).
- 5.2. Sealing
- ADA\_033 The following sealing requirements shall apply:
- the adaptor housing shall be sealed (see ADA\_017),
  - the housing of the embedded sensor shall be sealed to the adaptor housing, unless it is not possible to remove the embedded sensor without breaking the seal(s) of the adaptor housing (see ADA\_018),
  - the adaptor housing shall be sealed to the vehicle,
  - the connection between the adaptor and the equipment which provides its incoming pulses shall be sealed on both ends (to the extent of what is reasonably possible).
6. CHECKS, INSPECTIONS AND REPAIRS
- 6.1. Periodic inspections
- ADA\_034 When an adaptor is used, each periodic inspection (periodic inspection means in compliance with Requirement 256 through to Requirement 258 of Chapter VI of Annex 1B) of the recording equipment shall include the following checks (257):

---

*Changes to legislation: There are currently no known outstanding effects for the Council Regulation (EEC) No 3821/85. (See end of Document for details)*

---

- that the adaptor carries the appropriate type approval markings,
- that the seals on the adaptor and its connections are intact,
- that the adaptor is installed as indicated on the installation plaque,
- that the adaptor is installed as specified by the adapter and/or vehicle manufacturer,
- that mounting an adaptor is authorised for the inspected vehicle.

## 7. TYPE APPROVAL OF RECORDING EQUIPMENT WHEN AN ADAPTOR IS USED

### 7.1. General points

- ADA\_035 Recording equipment shall be submitted for type approval complete, with the adaptor (269).
- ADA\_036 Any adaptor may be submitted for its own type approval, or for type approval as a component of a recording equipment.
- ADA\_037 Such type approval shall include functional tests involving the adaptor. Positive results to each of these tests are stated by an appropriate certificate (270).

### 7.2. Functional certificate

- ADA\_038 A functional certificate of an adaptor or of recording equipment including an adaptor shall be delivered to the adaptor manufacturer only after all the following minimum functional tests have been successfully passed.

No	Test	Description	Related requirements
1.	<b>Administrative examination</b>		
1.1.	Documentation	Correctness of documentation of the adaptor	
2.	<b>Visual inspection</b>		
2.1.	Compliance of the adaptor with documentation		
2.2.	Identification/markings of the adaptor		ADA_026, ADA_027
2.3.	Materials of the adaptor		163 to 167 ADA_025
2.4.	Sealing		ADA_017, ADA_018, ADA_035
3.	<b>Functional tests</b>		
3.1.	Inducing the speed pulses to the embedded motion sensor		ADA_013

**Changes to legislation:** There are currently no known outstanding effects for the Council Regulation (EEC) No 3821/85. (See end of Document for details)

3.2.	Interfacing and adapting incoming speed pulses		ADA_011, ADA_012
3.3.	Motion measurement accuracy		022 to 026
[ <sup>F18</sup> 3.3.	Check that the adaptor is immune to magnetic fields. Alternatively, verify that the adaptor reacts to magnetic fields disturbing vehicle motion detection so that a connected VU can detect, record and store sensor faults		161a]
4.	<b>Environmental tests</b>		
4.1.	Manufacturer test results	Results of manufacturer environment tests	ADA_020, ADA_021, ADA_022, ADA_023, ADA_024
5.	<b>EMC</b>		
5.1.	Radiated emissions and susceptibility	Verify compliance with Directive 2006/28/EC	ADA_023
5.2.	Manufacturer test results	Results of manufacturer environment tests	ADA_023]]]]

## ANNEX II

## APPROVAL MARK AND CERTIFICATE

## I. APPROVAL MARK

1. The approval mark shall be made up of:
  - a rectangle, within which shall be placed the letter 'e' followed by a distinguishing number or letter for the country which has issued the approval in accordance with the following conventional signs:

[ <sup>F25</sup> Belgium	6,
[ <sup>F26</sup> Bulgaria	34,]
Czech Republic	8,
Denmark	18,
Germany	1,
Estonia	29,
Greece	23,

*Changes to legislation: There are currently no known outstanding effects for the Council Regulation (EEC) No 3821/85. (See end of Document for details)*

Spain	9,
France	2,
[ <sup>F27</sup> Croatia	25,]
Ireland	24,
Italy	3,
Cyprus	CY,
Latvia	32,
Lithuania	36,
Luxembourg	13,
Hungary	7,
Malta	MT,
Netherlands	4,
Austria	12,
Poland	20,
Portugal	21,
[ <sup>F26</sup> Romania	19,]
Slovenia	26,
Slovakia	27,
Finland	17,
Sweden	5,
United Kingdom	11,]

and

- an approval number corresponding to the number of the approval certificate drawn up for prototype of the recording equipment or the record sheet [<sup>F28</sup>or of a tachograph card], placed at any point within the immediate proximity of this rectangle.

#### Textual Amendments

- F25** Substituted by [Act concerning the conditions of accession of the Czech Republic, the Republic of Estonia, the Republic of Cyprus, the Republic of Latvia, the Republic of Lithuania, the Republic of Hungary, the Republic of Malta, the Republic of Poland, the Republic of Slovenia and the Slovak Republic and the adjustments to the Treaties on which the European Union is founded.](#)
- F26** Inserted by [Council Regulation \(EC\) No 1791/2006 of 20 November 2006 adapting certain Regulations and Decisions in the fields of free movement of goods, freedom of movement of persons, company law, competition policy, agriculture \(including veterinary and phytosanitary legislation\), transport policy, taxation, statistics, energy, environment, cooperation in the fields of justice and home affairs, customs union, external relations, common foreign and security policy and institutions, by reason of the accession of Bulgaria and Romania.](#)
- F27** Inserted by [Council Regulation \(EU\) No 517/2013 of 13 May 2013 adapting certain regulations and decisions in the fields of free movement of goods, freedom of movement for persons, company law,](#)

**Changes to legislation:** There are currently no known outstanding effects for the Council Regulation (EEC) No 3821/85. (See end of Document for details)

competition policy, agriculture, food safety, veterinary and phytosanitary policy, transport policy, energy, taxation, statistics, trans-European networks, judiciary and fundamental rights, justice, freedom and security, environment, customs union, external relations, foreign, security and defence policy and institutions, by reason of the accession of the Republic of Croatia.

**F28** Inserted by Commission Regulation (EC) No 1360/2002 of 13 June 2002 adapting for the seventh time to technical progress Council Regulation (EEC) No 3821/85 on recording equipment in road transport (Text with EEA relevance).

2. The approval mark shall be shown on the descriptive plaque of each set of equipment [F14,] on each record sheet [F28 and on each tachograph card]. It must be indelible and must always remain clearly legible.
3. The dimensions of the approval mark drawn below are expressed in millimetres, these dimensions being minima. The ratios between the dimensions must be maintained.

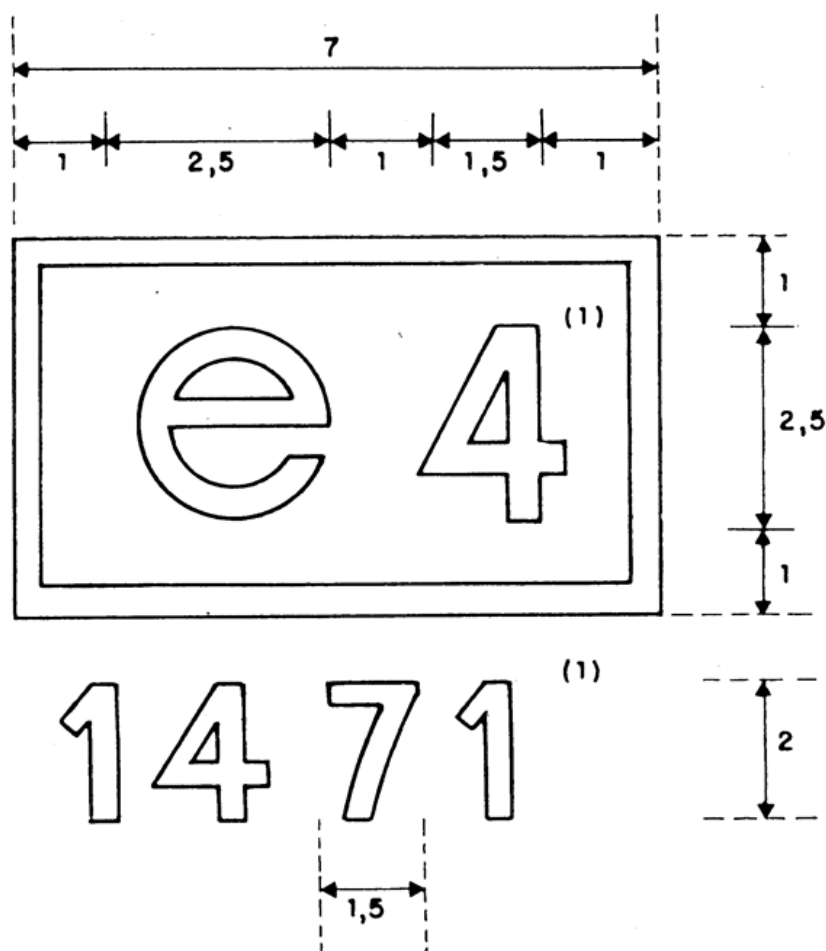

(1) These figures are shown for guidance only.

---

*Changes to legislation: There are currently no known outstanding effects for the Council Regulation (EEC) No 3821/85. (See end of Document for details)*

---

## II. APPROVAL CERTIFICATE [F28] FOR PRODUCTS COMPLIANT WITH ANNEX I]

A State having granted approval shall issue the applicant with an approval certificate, the model for which is given below. When informing other Member States of approvals issued or, if the occasion should arise, withdrawn, a Member State shall use copies of that certificate.



*Changes to legislation: There are currently no known outstanding effects for the Council Regulation (EEC) No 3821/85. (See end of Document for details)*

**APPROVAL CERTIFICATE**

Name of competent administration .....

Notification concerning <sup>(1)</sup>:

- approval of a type of recording equipment
- withdrawal of approval of a type of recording equipment
- approval of a model record sheet
- withdrawal of approval of a record sheet

Approval No .....

1. Trade mark or name .....

2. Name of type or model .....

3. Name of manufacturer .....

4. Address of manufacturer .....

5. Submitted for approval on .....

6. Tested at .....

7. Date and number of test report .....

8. Date of approval .....

9. Date of withdrawal of approval .....

10. Type or types of recording equipment in which sheet is designed to be used .....

11. Place .....

12. Date .....

13. Descriptive documents annexed .....

14. Remarks

(Signature)

<sup>(1)</sup> Delete items not applicable.

*Changes to legislation: There are currently no known outstanding effects for the Council Regulation (EEC) No 3821/85. (See end of Document for details)*

A State, having granted approval, shall issue the applicant with an approval certificate, the model of which is given below. When informing other Member States of approvals issued or, if the occasion should arise, withdrawn, a Member State shall use copies of that certificate.

---

APPROVAL CERTIFICATE FOR PRODUCTS COMPLIANT WITH ANNEX I B

---

Name of competent administration .....

Notification concerning <sup>(3)</sup>:

- approval of
- withdrawal of approval of
- recording equipment model
- recording equipment component <sup>(4)</sup> .....
- a driver's card
- a workshop card
- a company card
- a controller's card

Approval No .....

1. Manufacturing brand or trademark .....
2. Name of model .....
3. Name of manufacturer .....
4. Address of manufacturer .....
5. Submitted for approval for .....
6. Laboratory(ies) .....
7. Date and number of the test(s) .....
8. Date of approval .....
9. Date of withdrawal of approval .....
10. Model of recording equipment component(s) with which the component is designed to be used
11. Place .....
12. Date .....
13. Descriptive documents annexed .....

14. Remarks (including the position of seals if applicable)

.....  
(signature)

<sup>(3)</sup> Tick the relevant boxes.

<sup>(4)</sup> Specify the component dealt with in the notification.

---

**Changes to legislation:** There are currently no known outstanding effects for the Council Regulation (EEC) No 3821/85. (See end of Document for details)

---

*Changes to legislation:* There are currently no known outstanding effects for the Council Regulation (EEC) No 3821/85. (See end of Document for details)

- (1) OJ No C 100, 12. 4. 1984, p. 3, and OJ No C 223, 3. 9. 1985, p. 5.
- (2) OJ No C 122, 20. 5. 1985, p. 168.
- (3) OJ No C 104, 25. 4. 1985, p. 4, and OJ No C 303, 25. 11. 1985, p. 29.
- (4) OJ No L 164, 27. 7. 1970, p. 1.
- (5) OJ No L 334, 24. 12. 1977, p. 11.
- (6) See page 1 of this Official Journal.
- (7) [<sup>F2</sup>OJ L 102, 11.4.2006, p. 1]
- (8) [<sup>F3</sup>OJ L 57, 2.3.1992, p.27.]
- (9) [<sup>F2</sup>OJ L 80, 23.3.2002, p. 35.]
- (10) [<sup>F12</sup>[<sup>F13</sup>OJ No L 42, 23. 2. 1970, p. 1.]]
- (11) [<sup>F3</sup>[<sup>F14</sup>This way of computing the continuous driving time and the cumulative break time serves into the recording equipment for computing the continuous driving time warning. It does not prejudice the legal interpretation to be made of these times.  
[<sup>F18</sup>Alternative ways of computing the continuous driving time and the cumulative break time may be used to replace these definitions if they have been made obsolete by updates in other relevant legislation.]]]
- (12) [<sup>F3</sup>[<sup>F14</sup>UNKNOWN periods correspond to periods where the driver's card was not inserted in a recording equipment and for which no manual entry of driver activities was made.]]
- (13) [<sup>F3</sup>[<sup>F14</sup>Directive 97/27/EC of 22 July 1997 relating to the masses and dimensions of certain categories of motor vehicles and their trailers and amending Directive 70/156/EEC (OJ L 233, 25.8.1997, p. 1).]]
- (14) [<sup>F3</sup>[<sup>F14</sup>OJ L 57, 2.3.1992, p. 27.]]
- (15) [<sup>F3</sup>[<sup>F14</sup>Council Recommendation 95/144/EC of 7 April 1995 on common information technology security evaluation criteria (OJ L 93, 26.4.1995, p. 27).]]
- (16) [<sup>F3</sup>[<sup>F14</sup>OJ L 129, 14.5.1992, p. 95.]]
- (17) [<sup>F3</sup>[<sup>F14</sup>Directive 76/114/EEC, of 18 December 1975 on the approximation of the laws of the Member States relating to statutory plates and inscriptions for motor vehicles and their trailers, and their location and method of attachment (OJ L 24, 30.1.1976, p. 1).]]
- (18) [<sup>F3</sup>[<sup>F14</sup>OJ L 281, 23.11.1995, p. 31.]]
- (19) [<sup>F3</sup>[<sup>F14</sup>OJ L 266, 8.11.1995, p. 1.]]
- (20) [<sup>F3</sup>[<sup>F14</sup>OJ L 152, 6.7.1972, p. 15.]]
- (21) [<sup>F3</sup>[<sup>F14</sup>OJ L 266, 8.11.1995, p. 1.]]
- (22) [<sup>F3</sup>[<sup>F14</sup>OJ L 281, 23.11.1995, p. 31.]]
- (23) [<sup>F3</sup>[<sup>F14</sup>[<sup>F15</sup>OJ L 102, 11.4.2006, p. 1.]]]
- (24) [<sup>F3</sup>[<sup>F14</sup>[<sup>F15</sup>OJ L 21, 24.1.2009, p. 3.]]]
- (25) [<sup>F3</sup>[<sup>F14</sup>[<sup>F15</sup>The card inserted will trigger the appropriate access rights to the downloading function and to the data. It shall, however, be possible to download data from a driver card inserted into one of the VU slots when no other card is inserted in the other slot.]]]
- (26) [<sup>F3</sup>[<sup>F14</sup>[<sup>F16</sup>OJ L 65, 7.3.2006, p. 27.]]]

#### Textual Amendments

- F2** Substituted by Regulation (EC) No 561/2006 of the European Parliament and of the Council of 15 March 2006 on the harmonisation of certain social legislation relating to road transport and amending

---

**Changes to legislation:** *There are currently no known outstanding effects for the Council Regulation (EEC) No 3821/85. (See end of Document for details)*

---

- Council Regulations (EEC) No 3821/85 and (EC) No 2135/98 and repealing Council Regulation (EEC) No 3820/85 (Text with EEA relevance).
- F3** Inserted by Council Regulation (EC) No 2135/98 of 24 September 1998 amending Regulation (EEC) No 3821/85 on recording equipment in road transport and Directive 88/599/EEC concerning the application of Regulations (EEC) No 3820/85 and (EEC) No 3821/85.
- F12** Substituted by Commission Regulation (EC) No 2479/95 of 25 October 1995 adapting to technical progress Council Regulation (EEC) No 3821/85 on recording equipment in road transport (Text with EEA relevance).
- F13** Inserted by Commission Regulation (EC) No 1056/97 of 11 June 1997 adapting to technical progress Council Regulation (EEC) No 3821/85 on recording equipment in road transport (Text with EEA relevance).
- F14** Substituted by Commission Regulation (EC) No 1360/2002 of 13 June 2002 adapting for the seventh time to technical progress Council Regulation (EEC) No 3821/85 on recording equipment in road transport (Text with EEA relevance).
- F15** Substituted by Commission Regulation (EU) No 1266/2009 of 16 December 2009 adapting for the tenth time to technical progress Council Regulation (EEC) No 3821/85 on recording equipment in road transport (Text with EEA relevance).
- F16** Inserted by Commission Regulation (EC) No 68/2009 of 23 January 2009 adapting for the ninth time to technical progress Council Regulation (EEC) No 3821/85 on recording equipment in road transport (Text with EEA relevance).
- F18** Inserted by Commission Regulation (EU) No 1266/2009 of 16 December 2009 adapting for the tenth time to technical progress Council Regulation (EEC) No 3821/85 on recording equipment in road transport (Text with EEA relevance).

**Changes to legislation:**

There are currently no known outstanding effects for the Council Regulation (EEC) No 3821/85.