

This text is meant purely as a documentation tool and has no legal effect. The Union's institutions do not assume any liability for its contents. The authentic versions of the relevant acts, including their preambles, are those published in the Official Journal of the European Union and available in EUR-Lex. Those official texts are directly accessible through the links embedded in this document

► **B** **COMMISSION DELEGATED REGULATION (EU) 2017/654**
 of 19 December 2016

supplementing Regulation (EU) 2016/1628 of the European Parliament and of the Council with regard to technical and general requirements relating to emission limits and type-approval for internal combustion engines for non-road mobile machinery

(OJ L 102, 13.4.2017, p. 1)

Amended by:

		Official Journal		
		No	page	date
► <u>M1</u>	Commission Delegated Regulation (EU) 2018/236 of 20 December 2017	L 50	1	22.2.2018
► <u>M2</u>	Commission Delegated Regulation (EU) 2018/989 of 18 May 2018	L 182	61	18.7.2018

**COMMISSION DELEGATED REGULATION (EU) 2017/654****of 19 December 2016****supplementing Regulation (EU) 2016/1628 of the European Parliament and of the Council with regard to technical and general requirements relating to emission limits and type-approval for internal combustion engines for non-road mobile machinery***Article 1***Definitions**

The following definitions shall apply:

- (1) ‘wobbe index’ or ‘W’ means the ratio of the corresponding calorific value of a gas per unit volume and the square root of its relative density under the same reference conditions:

$$W = H_{\text{gas}} \times \sqrt{\rho_{\text{air}} / \rho_{\text{gas}}}$$

- (2) ‘ λ -shift factor’ or ‘ S_{λ} ’ means an expression that describes the required flexibility of the engine management system regarding a change of the excess-air ratio λ if the engine is fuelled with a gas composition different from pure methane;
- (3) ‘liquid-fuel mode’ means the normal operating mode of a dual-fuel engine during which the engine does not use any gaseous fuel for any engine operating condition;
- (4) ‘dual-fuel mode’ means the normal operating mode of a dual-fuel engine during which the engine simultaneously uses liquid fuel and a gaseous fuel at some engine operating conditions;
- (5) ‘particulate after-treatment system’ means an exhaust after-treatment system designed to reduce emissions of particulate pollutants through a mechanical, aerodynamic, diffusional or inertial separation;
- (6) ‘governor’ means a device or control strategy that automatically controls engine speed or load, other than an over-speed limiter as installed in an engine of category NRSh limiting the maximum engine speed for the sole purpose of preventing the engine operating at speeds in excess of a certain limit;
- (7) ‘ambient temperature’ means, in relation to a laboratory environment (e.g. filter weighing room or chamber), the temperature within the specified laboratory environment;
- (8) ‘base emission control strategy’ or ‘BECS’ means an emission control strategy that is active throughout the range of torque and speed over which the engine operates, unless an auxiliary emission control strategy (AECS) is activated;

▼B

- (9) 'reagent' means any consumable or non-recoverable medium required and used for the effective operation of the exhaust after-treatment system;
- (10) 'auxiliary emission control strategy' or 'AECS' means an emission control strategy that is activated and temporarily modifies a base emission control strategy (BECS) for a specific purpose and in response to a specific set of ambient and/or operating conditions and only remains in operation as long as those conditions exist;
- (11) 'good engineering judgment' means judgments consistent with generally accepted scientific and engineering principles and available relevant information;
- (12) 'high speed' or ' n_{hi} ' means the highest engine speed where 70 % of the maximum power occurs;
- (13) 'low speed' or ' n_{lo} ' means the lowest engine speed where 50 % of the maximum power occurs;
- (14) 'maximum power' or ' P_{max} ' means the maximum power in kW as designed by the manufacturer;
- (15) 'partial flow dilution' means the method of analysing the exhaust gas whereby a part of the total exhaust gas flow is separated, then mixed with an appropriate amount of dilution air prior to reaching the particulate sampling filter;
- (16) 'drift' means the difference between a zero or calibration signal and the respective value reported by a measurement instrument immediately after it was used in an emission test;
- (17) 'to span' means to adjust an instrument so that it gives a proper response to a calibration standard that represents between 75 % and 100 % of the maximum value in the instrument range or expected range of use;
- (18) 'span gas' means a purified gas mixture used to span gas analysers;
- (19) 'HEPA filter' means high-efficiency particulate air filters that are rated to achieve a minimum initial particle-removal efficiency of 99,97 % using ASTM F 1471-93;
- (20) 'calibration' means the process of setting a measurement system's response to an input signal so that its output agrees with a range of reference signals;
- (21) 'specific emissions' means the mass emissions expressed in g/kWh;
- (22) 'operator demand' means an engine operator's input to control engine output;

▼B

- (23) ‘maximum torque speed’ means the engine speed at which the maximum torque is obtained from the engine, as designed by the manufacturer;
- (24) ‘engine governed speed’ means the engine operating speed when it is controlled by the installed governor;
- (25) ‘open crankcase emissions’ means any flow from an engine's crankcase that is emitted directly into the environment;
- (26) ‘probe’ means the first section of the transfer line which transfers the sample to the next component in the sampling system;
- (27) ‘test interval’ means a duration of time over which brake-specific emissions are determined;
- (28) ‘zero gas’ means a gas that yields the value zero as response to its input in an analyser;
- (29) ‘zeroed’ means that an instrument was adjusted in a manner that it gives a zero response to a zero calibration standard, such as purified nitrogen or purified air;
- (30) ‘variable-speed non-road steady-state test cycle’ (hereinafter ‘variable-speed NRSC’) means a non-road steady-state test cycle that is not a constant-speed NRSC;
- (31) ‘constant-speed non-road steady-state test cycle’ (hereinafter ‘constant-speed NRSC’) means any of the following non-road steady-state test cycles defined in Annex IV to Regulation (EU) 2016/1628: D2, E2, G1, G2 or G3;
- (32) ‘updating-recording’ means the frequency at which the analyser provides new, current, values;
- (33) ‘calibration gas’ means a purified mixture of gases used to calibrate gas analysers;
- (34) ‘stoichiometric’ means relating to the particular ratio of air and fuel such that if the fuel were fully oxidised, there would be no remaining fuel or oxygen;
- (35) ‘storage medium’ means a particulate filter, sample bag, or any other storage device used for batch sampling;
- (36) ‘full flow dilution’ means the method of mixing the exhaust gas flow with dilution air prior to separating a fraction of the diluted exhaust gas flow for analysis;
- (37) ‘tolerance’ means the interval in which 95 % of a set of recorded values of a certain quantity shall lie, with the remaining 5 % of the recorded values deviating from the tolerance interval;

▼ B

- (38) ‘service mode’ means a special mode of a dual-fuel engine that is activated for the purpose of repairing, or of moving the non-road mobile machinery to a safe location when operation in the dual-fuel mode is not possible;

*Article 2***Requirements for any other specified fuels, fuel mixtures or fuel emulsions**

The reference fuels and other specified fuels, fuel mixtures or fuel emulsions included by a manufacturer in an application for EU type-approval as referred to in Article 25(2) of Regulation (EU) 2016/1628 shall comply with the technical characteristics and be described in the information folder as laid down in Annex I to this Regulation.

*Article 3***Arrangements with regard to conformity of production**

In order to ensure that the engines in production conform to the approved type in accordance with Article 26(1) of Regulation (EU) 2016/1628, the approval authorities shall take the measures and follow the procedures laid down in Annex II to this Regulation.

▼ M2*Article 4***Methodology for adapting the emission laboratory test results to include the deterioration factors**

The emission laboratory test results shall be adapted to include the deterioration factors, comprising those related with the measurement of the particle number (PN) and with gaseous-fuelled engines, referred to in Article 25(1)(c) of Regulation (EU) 2016/1628, in accordance with the methodology laid down in Annex III to this Regulation.

▼ B*Article 5***Requirements with regard to emission control strategies, NO_x control measures and particulate control measures**

The measurements and tests in respect of the emission control strategies referred to in Article 25(3)(f)(i) of Regulation (EU) 2016/1628 and of the NO_x control measures referred to in Article 25(3)(f)(ii) of that Regulation and the particulate pollutant emission control measures, as well as the documentation required to demonstrate them, shall be conducted in compliance with the technical requirements laid down in Annex IV to this Regulation.

▼B*Article 6***Measurements and tests with regard to the area associated with the non-road steady-state test cycle**

The measurements and tests with regard to the area referred to in Article 25(3)(f)(iii) of Regulation (EU) 2016/1628 shall be conducted in compliance with the detailed technical requirements laid down in Annex V to this Regulation.

*Article 7***Conditions and methods for the conduct of tests**

The conditions for conduct of the tests referred to in Articles 25(3)(a) and (b) of Regulation (EU) 2016/1628, the methods for determining the engine load and speed settings referred to in Article 24 of that Regulation, the methods for taking account of emissions of crankcase gases referred to in Article 25(3)(e)(i) of that Regulation and the methods for determining and taking account of continuous and periodic regeneration of exhaust after-treatment systems referred to in Article 25(3)(e)(ii) of that Regulation shall meet the requirements laid down in Sections 5 and 6 of Annex VI to this Regulation.

*Article 8***Procedures for the conduct of tests**

The tests referred to in points (a) and (f)(iv) of Article 25(3) of Regulation (EU) 2016/1628 shall be conducted in accordance with the procedures laid down in Section 7 of Annex VI and in Annex VIII to this Regulation.

*Article 9***Procedures for emission measurement and sampling**

The emission measurement and sampling referred to in Article 25(3)(b) of Regulation (EU) 2016/1628 shall be conducted in accordance with the procedures laid down in Section 8 of Annex VI to this Regulation and in Appendix 1 to that Annex.

*Article 10***Apparatus for the conduct of tests and for emission measurement and sampling**

The apparatus for the conduct of tests as referred to in Article 25(3)(a) of Regulation (EU) 2016/1628 and for emission measurement and sampling as referred to in Article 25(3)(b) of that Regulation shall comply with the technical requirements and characteristics laid down in Section 9 of Annex VI to this Regulation.



Article 11

Method for data evaluation and calculations

The data referred to in Article 25(3)(c) of Regulation (EU) 2016/1628 shall be evaluated and calculated in accordance with the method laid down in Annex VII to this Regulation.

Article 12

Technical characteristics of the reference fuels

The reference fuels referred to in Article 25(2) of Regulation (EU) 2016/1628 shall meet the technical characteristics laid down in Annex IX to this Regulation.

Article 13

Detailed technical specifications and conditions for delivering an engine separately from its exhaust after-treatment system

Where a manufacturer delivers an engine separately from its exhaust after-treatment system to an original equipment manufacturer ('OEM') in the Union, as provided for in Article 34(3) of Regulation (EU) 2016/1628, that delivery shall comply with the detailed technical specifications and conditions laid down in Annex X to this Regulation.

Article 14

Detailed technical specifications and conditions for the temporary placing on the market for the purposes of field testing

Engines that have not been EU type-approved in accordance with Regulation (EU) 2016/1628 shall be authorised, in accordance with Article 34(4) of that Regulation, to be temporarily placed on the market for the purposes of field testing if they comply with the detailed technical specifications and conditions laid down in Annex XI to this Regulation.

Article 15

Detailed technical specifications and conditions for special purpose engines

EU type-approvals for special purpose engines and authorisations for the placing on the market of those engines shall be granted in accordance with Article 34(5) and (6) of Regulation (EU) 2016/1628 if the detailed technical specifications and conditions laid down in Annex XII to this Regulation are fulfilled.

Article 16

Acceptance of equivalent engine type-approvals

The UNECE regulations, or amendments thereto, referred to in Article 42(4)(a) of Regulation (EU) 2016/1628 and the Union acts referred to in Article 42(4)(b) of that Regulation are set out in Annex XIII to this Regulation.

▼ B*Article 17***Details of the relevant information and instructions for OEMs**

The details of the information and instructions for OEMs referred to in Article 43(2), (3) and (4) of Regulation (EU) 2016/1628 are laid down in Annex XIV to this Regulation.

*Article 18***Details of the relevant information and instructions for end-users**

The details of the information and instructions for end-users referred to in Article 43(3) and (4) of Regulation (EU) 2016/1628 are laid down in Annex XV to this Regulation.

*Article 19***Performance standards and assessment of technical services**

1. Technical services shall comply with the performance standards laid down in Annex XVI.
2. Approval authorities shall assess the technical services in accordance with the procedure laid down in Annex XVI to this Regulation.

*Article 20***Characteristics of the steady-state and transient test cycles**

The steady-state and transient test cycles, referred to in Article 24 of Regulation (EU) 2016/1628, shall meet the characteristics laid down in Annex XVII to this Regulation.

▼ M2*Article 20a***Transitional provisions**

1. Notwithstanding the application of the provisions of this Regulation, as amended by Commission Delegated Regulation (EU) 2018/989, approval authorities shall, until 31 December 2018, also continue to grant EU type-approvals to engine types or engine families in accordance with this Regulation, in its version applicable on 6 August 2018.
2. Notwithstanding the application of the provisions of this Regulation, as amended by Commission Delegated Regulation (EU) 2018/989, the Member States shall, until 30 June 2019, also permit the placing on the market of engines based on an engine type approved in accordance with this Regulation, in its version applicable on 6 August 2018.

▼B

Article 21

Entry into force and application

This Regulation shall enter into force on the twentieth day following that of its publication in the *Official Journal of the European Union*.

This Regulation shall be binding in its entirety and directly applicable in all Member States.



ANNEXES

Annex Number	Annex title	Page
I	Requirements for any other specified fuels, fuel mixtures or fuel emulsions	
II	Arrangements with regard to conformity of production	
III	Methodology for adapting the emission laboratory test results to include the deterioration factors	
IV	Requirements with regard to emission control strategies, NO _x control measures and particulate control measures	
V	Measurements and tests with regard to the area associated with the non-road steady-state test cycle	
VI	Conditions, methods, procedures and apparatus for the conduct of tests and for emission measurement and sampling	
VII	Method for data evaluation and calculations	
VIII	Performance requirements and test procedures for dual-fuel engines	
IX	Technical characteristics of the reference fuels	
X	Detailed technical specifications and conditions for delivering an engine separately from its exhaust after-treatment system	
XI	Detailed technical specifications and conditions for the temporary placing on the market for the purposes of field testing	
XII	Detailed technical specifications and conditions for special purpose engines	
XIII	Acceptance of equivalent engine type-approvals	
XIV	Details of the relevant information and instructions for OEMs	
XV	Details of the relevant information and instructions for end-users	
XVI	Performance standards and assessment of technical services	
XVII	Characteristics of the steady-state and transient test cycles	

▼B*ANNEX I***Requirements for any other specified fuels, fuel mixtures or fuel emulsions****1. Requirements for engines fuelled with liquid fuels**

1.1. When applying for an EU type-approval, manufacturers may select one of the following options with regard to the engine's fuel range:

- (a) standard fuel range engine, in accordance with the requirements set out in point 1.2; or,
- (b) fuel-specific engine, in accordance with the requirements set out in point 1.3.

1.2. Requirements for a standard fuel range (diesel, petrol) engine

A standard fuel range engine shall meet the requirements specified in points 1.2.1 to 1.2.4.

1.2.1. The parent engine shall meet the applicable limit values set out in Annex II to Regulation (EU) 2016/1628 and the requirements set out in this Regulation when the engine is operated on the reference fuels specified in sections 1.1 or 2.1 of Annex IX.

▼M2

1.2.2. In the absence of either a standard from the European Committee for Standardization ('CEN standard') for non-road gas-oil or a table of fuel properties for non-road gas-oil in Directive 98/70/EC of the European Parliament and of the Council⁽¹⁾, the diesel (non-road gas-oil) reference fuel in Annex IX shall represent market non-road gas-oils with a sulphur content not greater than 10 mg/kg, cetane number not less than 45 and a fatty-acid methyl ester ('FAME') content not greater than 8,0 % v/v. Except where otherwise permitted in accordance with points 1.2.2.1, 1.2.3 and 1.2.4, the manufacturer shall make a corresponding declaration to the end-users in accordance with the requirements in Annex XV that operation of the engine on non-road gas-oil is limited to those fuels with a sulphur content not greater than 10 mg/kg (20 mg/kg at point of final distribution) cetane number not less than 45 and a FAME content not greater than 8,0 % v/v. The manufacturer may optionally specify other parameters (e.g. for lubricity).

▼B

1.2.2.1. ►M2 The engine manufacturer shall not indicate at any time that an engine type or engine family may be operated within the Union on market fuels other than those that comply with the requirements in this point unless the manufacturer additionally complies with the requirement in point 1.2.3 ◀

(a) In the case of petrol, Directive 98/70/EC or the CEN standard EN 228:2012. Lubricating oil may be added according to the specification of the manufacturer;

(b) In the case of diesel (other than non-road gas-oil), Directive 98/70/EC of the European Parliament and of the Council or the CEN standard EN 590:2013;

⁽¹⁾ Directive 98/70/EC of the European Parliament and of the Council of 13 October 1998 relating to the quality of petrol and diesel fuels and amending Council Directive 93/12/EEC (OJ L 350, 28.12.1998, p. 58).

▼ M2

- (c) In the case of diesel (non-road gas-oil), Directive 98/70/EC and also both a cetane number not less than 45 and FAME not greater than 8,0 % v/v.

▼ B

1.2.3. If the manufacturer permits engines to run on additional market fuels other than those identified in point 1.2.2, such as running on B100 (EN 14214:2012+A1:2014), B20 or B30 (EN16709:2015), or on specific fuels, fuel mixtures or fuel emulsions, all of the following actions shall be taken by the manufacturer in addition to the requirements of point 1.2.2.1:

- (a) declare, in the information document set out in Commission Implementing Regulation (EU) 2017/656 ⁽¹⁾, the specification of the commercial fuels, fuel mixtures or emulsions on which the engine family is capable to run;
- (b) demonstrate the capability of the parent engine to meet the requirements of this Regulation on the fuels, fuel mixtures or emulsions declared;
- (c) be liable to meet the requirements of in-service monitoring specified in Commission Delegated Regulation (EU) 2017/655 ⁽²⁾ on the fuels, fuel mixtures or emulsions declared, including any blend between the declared fuels, fuel mixtures or emulsions, and the applicable market fuel identified in point 1.2.2.1.

1.2.4. For SI engines, the fuel/oil mixture ratio must be the ratio which shall be recommended by the manufacturer. The percentage of oil in the fuel/lubricant mixture shall be recorded in the information document set out in Implementing Regulation (EU) 2017/656.

1.3. Requirements for a fuel-specific (ED 95 or E 85) engine

A specific fuel (ED 95 or E 85) engine shall meet the requirements specified in points 1.3.1 and 1.3.2.

1.3.1. For ED 95, the parent engine shall meet the applicable limit values set out in Annex II to Regulation (EU) 2016/1628 and the requirements set out in this Regulation when the engine is operated on the reference fuel specified in point 1.2 of Annex IX.

1.3.2. For E 85, the parent engine shall meet the applicable limit values set out in Annex II to Regulation (EU) 2016/1628 and the requirements set out in this Regulation when the engine is operated on the reference fuel specified point 2.2 of Annex IX.

⁽¹⁾ Commission Implementing Regulation (EU) 2017/656 of 19 December 2016 laying down the administrative requirements relating to emission limits and type-approval of internal combustion engines for non-road mobile machinery in accordance with Regulation (EU) 2016/1628 of the European Parliament and of the Council (See page 364 of this Official Journal).

⁽²⁾ Commission Delegated Regulation (EU) 2017/655 of 19 December 2016 supplementing Regulation (EU) 2016/1628 of the European Parliament and of the Council with regard to monitoring of gaseous pollutant emissions from in-service internal combustion engines installed in non-road mobile machinery (See page 334 of this Official Journal).

▼B

2. **Requirements for engines fuelled with natural gas/biomethane (NG) or liquefied petroleum gas (LPG), including dual-fuel engines**
- 2.1. When applying for an EU type-approval, manufacturers may select one of the following options with regard to the engine's fuel range:
- (a) universal fuel range engine, in accordance with the requirements set out in point 2.3;
 - (b) restricted fuel range engine, in accordance with the requirements set out in point 2.4;
 - (c) fuel-specific engine, in accordance with the requirements set out in point 2.5.
- 2.2. Tables summarizing the requirements for EU type-approval of natural gas/biomethane fuelled engines, LPG-fuelled engines and dual-fuel engines are provided in Appendix 1.
- 2.3. Requirements for a universal fuel range engine
- 2.3.1. For engines fuelled with natural gas/biomethane, including dual-fuel engines, the manufacturer shall demonstrate the parent engine's capability to adapt to any natural gas/biomethane composition that may occur across the market. That demonstration shall be carried out in accordance with this section 2 and in case of dual-fuel engines, also in accordance with the additional provisions regarding the fuel adaptation procedure set out in point 6.4 of Annex VIII.
- 2.3.1.1. For engines fuelled with compressed natural gas/biomethane (CNG) there are generally two types of fuel, high calorific fuel (H-gas) and low calorific fuel (L-gas), but with a significant spread within both ranges; they differ significantly in their energy content expressed by the Wobbe Index and in their λ -shift factor (S_λ). Natural gases with a λ -shift factor between 0,89 and 1,08 ($0,89 \leq S_\lambda \leq 1,08$) are considered to belong to H-range, while natural gases with a λ -shift factor between 1,08 and 1,19 ($1,08 \leq S_\lambda \leq 1,19$) are considered to belong to L-range. The composition of the reference fuels reflects the extreme variations of S_λ .

The parent engine shall meet the requirements of this Regulation on the reference fuels G_R (fuel 1) and G_{25} (fuel 2), as specified in Annex IX, or on the equivalent fuels created using admixtures of pipeline gas with other gases as specified in Appendix 1 of Annex IX, without any manual readjustment to the engine fuelling system between the two tests (self-adaptation is required). One adaptation run is permitted after the change of the fuel. The adaption run shall consist of performing the pre-conditioning for the following emission test according to the respective test cycle. In the case of engines tested on the non-road steady-state test cycles ('NRSC'), where the pre-conditioning cycle is inadequate for the engine fuelling to self-adapt an alternative adaption run specified by the manufacturer may be performed prior to pre-conditioning the engine.

- 2.3.1.1.1. The manufacturer may test the engine on a third fuel (fuel 3) if the λ -shift factor (S_λ) lies between 0,89 (that is the lower range of G_R) and 1,19 (that is the upper range of G_{25}), for example when fuel 3 is a market fuel. The results of this test may be used as a basis for the evaluation of the conformity of the production.

▼B

- 2.3.1.2. For engines fuelled with liquefied natural gas/liquefied biomethane (LNG), the parent engine shall meet the requirements of this Regulation on the reference fuels G_R (fuel 1) and G_{20} (fuel 2), as specified in Annex IX, or on the equivalent fuels created using admixtures of pipeline gas with other gases as specified in Appendix 1 of Annex IX, without any manual readjustment to the engine fuelling system between the two tests (self-adaptation is required). One adaptation run is permitted after the change of the fuel. The adaption run shall consist of performing the pre-conditioning for the following emission test according to the respective test cycle. In the case of engines tested on the NRSC, where the pre-conditioning cycle is inadequate for the engine fuelling to self-adapt an alternative adaption run specified by the manufacturer may be performed prior to pre-conditioning the engine.
- 2.3.2. For engines fuelled with compressed natural gas/biomethane (CNG) which are self-adaptive for the range of H-gases on the one hand and the range of L-gases on the other hand, and which switch between the H-range and the L-range by means of a switch, the parent engine shall be tested on the relevant reference fuel as specified in Annex IX for each range, at each position of the switch. The fuels are G_R (fuel 1) and G_{23} (fuel 3) for the H-range of gases and G_{25} (fuel 2) and G_{23} (fuel 3) for the L-range of gases, or the equivalent fuels created using admixtures of pipeline gas with other gases as specified in Appendix 1 of Annex IX. The parent engine shall meet the requirements of this Regulation at both positions of the switch without any readjustment to the fuelling between the two tests at each position of the switch. One adaptation run is permitted after the change of the fuel. The adaption run shall consist of performing the pre-conditioning for the following emission test according to the respective test cycle. In the case of engines tested on the NRSC, where the pre-conditioning cycle is inadequate for the engine fuelling to self-adapt an alternative adaption run specified by the manufacturer may be performed prior to pre-conditioning the engine.
- 2.3.2.1. The manufacturers may test the engine on a third fuel instead of G_{23} (fuel 3) if the λ -shift factor (S_λ) lies between 0,89 (that is the lower range of G_R) and 1,19 (that is the upper range of G_{25}), for example when fuel 3 is a market fuel. The results of this test may be used as a basis for the evaluation of the conformity of the production.
- 2.3.3. For engines fuelled with natural gas/biomethane, the ratio of the emission results 'r' shall be determined for each pollutant as follows:

$$r = \frac{\text{emission result on reference fuel 2}}{\text{emission result on reference fuel 1}}$$

or,

$$r_a = \frac{\text{emission result on reference fuel 2}}{\text{emission result on reference fuel 3}}$$

and

$$r_b = \frac{\text{emission result on reference fuel 1}}{\text{emission result on reference fuel 3}}$$

▼ B

- 2.3.4. For engines fuelled with LPG the manufacturer shall demonstrate the parent engine's capability to adapt to any fuel composition that may occur across the market.

For engines fuelled with LPG there are variations in C₃/C₄ composition. These variations are reflected in the reference fuels. The parent engine shall meet the emission requirements on the reference fuels A and B as specified in Annex IX without any readjustment to the fuelling between the two tests. One adaptation run is permitted after the change of the fuel. The adaption run shall consist of performing the pre-conditioning for the following emission test according to the respective test cycle. In the case of engines tested on the NRSC, where the pre-conditioning cycle is inadequate for the engine fuelling to self-adapt an alternative adaption run specified by the manufacturer may be performed prior to pre-conditioning the engine.

- 2.3.4.1. The ratio of emission results 'r' shall be determined for each pollutant as follows:

$$r = \frac{\text{emission result on reference fuel B}}{\text{emission result on reference fuel A}}$$

- 2.4. Requirements for a restricted fuel range engine

A restricted fuel range engine shall meet the requirements specified in points 2.4.1 to 2.4.3.

▼ M2

- 2.4.1. Engines fuelled with CNG and designed for operation on either the range of H-gases or on the range of L-gases

▼ B

- 2.4.1.1. The parent engine shall be tested on the relevant reference fuel, as specified in Annex IX, for the relevant range. The fuels are G_R (fuel 1) and G₂₃ (fuel 3) for the H-range of gases and G₂₅ (fuel 2) and G₂₃ (fuel 3) for the L-range of gases or the equivalent fuels created using admixtures of pipeline gas with other gases as specified in Appendix 1 of Annex IX. The parent engine shall meet the requirements of this Regulation without any readjustment to the fuelling between the two tests. One adaptation run is permitted after the change of the fuel. The adaption run shall consist of performing the pre-conditioning for the following emission test according to the respective test cycle. In the case of engines tested on the NRSC, where the pre-conditioning cycle is inadequate for the engine fuelling to self-adapt an alternative adaption run specified by the manufacturer may be performed prior to pre-conditioning the engine.

- 2.4.1.2. The manufacturers may test the engine on a third fuel instead of G₂₃ (fuel 3) if the λ-shift factor (S_λ) lies between 0,89 (that is the lower range of G_R) and 1,19 (that is the upper range of G₂₅), for example when fuel 3 is a market fuel. The results of this test may be used as a basis for the evaluation of the conformity of the production.

▼ B

- 2.4.1.3. The ratio of emission results ‘r’ shall be determined for each pollutant as follows:

$$r = \frac{\text{emission result on reference fuel 2}}{\text{emission result on reference fuel 1}}$$

or,

$$r_a = \frac{\text{emission result on reference fuel 2}}{\text{emission result on reference fuel 3}}$$

and

$$r_b = \frac{\text{emission result on reference fuel 1}}{\text{emission result on reference fuel 3}}$$

▼ M2**▼ B**

- 2.4.2. For engines fuelled with natural gas or LPG and designed for operation on one specific fuel composition
- 2.4.2.1. The parent engine shall meet the emission requirements on the reference fuels G_R and G_{25} or on the equivalent fuels created using admixtures of pipeline gas with other gases as specified in Appendix 1 of Annex IX in the case of CNG, on the reference fuels G_R and G_{20} or on the equivalent fuels created using admixtures of pipeline gas with other gases as specified in Appendix 2 of Annex VI in the case of LNG, or on the reference fuels A and B in the case of LPG, as specified in Annex IX. Fine-tuning of the fuelling system is allowed between the tests. This fine-tuning will consist of a recalibration of the fuelling database, without any alteration to either the basic control strategy or the basic structure of the database. If necessary the exchange of parts that are directly related to the amount of fuel flow such as injector nozzles is allowed.
- 2.4.2.2. For engines fuelled with CNG, the manufacturer may test the engine on the reference fuels G_R and G_{23} , or on the reference fuels G_{25} and G_{23} , or on the equivalent fuels created using admixtures of pipeline gas with other gases as specified in Appendix 1 of Annex IX, in which case the EU type-approval is only valid for the H-range or the L-range of gases respectively.
- 2.4.2.3. On delivery to the customer the engine shall bear a label as specified in Annex III to Implementing Regulation (EU) 2017/656 stating for which fuel range composition the engine has been calibrated.
- 2.5. Requirements for a fuel-specific engine fuelled with liquefied natural gas/liquefied biomethane (LNG)
- A fuel-specific engine fuelled with liquefied natural gas/liquefied biomethane shall meet the requirements specified in points 2.5.1 to 2.5.2.
- 2.5.1. Fuel-specific engine fuelled with liquefied natural gas/liquefied biomethane (LNG)

▼ B

- 2.5.1.1. The engine shall be calibrated for a specific LNG gas composition resulting in a λ -shift factor not differing by more than 3 % from the λ -shift factor of the G₂₀ fuel specified in Annex IX, and the ethane content of which does not exceed 1,5 %.
- 2.5.1.2. If the requirements set out in point 2.5.1.1. are not fulfilled, the manufacturer shall apply for a universal fuel engine according to the specifications set out in point 2.1.3.2.

▼ M2

- 2.5.2. Fuel-specific dual-fuel engine fuelled with Liquefied Natural Gas (LNG)
- 2.5.2.1. For a dual-fuel engine family where the engines are calibrated for a specific LNG gas composition resulting in a λ -shift factor not differing by more than 3 % from the λ -shift factor of the G₂₀ fuel specified in Annex IX, and the ethane content of which does not exceed 1,5 %, the parent engine shall only be tested on the G₂₀ reference gas fuel, or on the equivalent fuel created using an admixture of pipeline gas with other gases, as specified in Appendix 1 of Annex IX.

▼ B

- 2.6. EU type-approval of a member of a family
- 2.6.1. With the exception of the case mentioned in point 2.6.2, the EU type-approval of a parent engine shall be extended to all family members, without further testing, for any fuel composition within the range for which the parent engine has been EU type-approved (in the case of engines described in point 2.5) or the same range of fuels (in the case of engines described in either point 2.3 or 2.4) for which the parent engine has been EU type-approved.
- 2.6.2. Where the technical service determines that, with regard to the selected parent engine the submitted application does not fully represent the engine family defined in Annex IX to Implementing Regulation (EU) 2017/656, an alternative and if necessary an additional reference test engine may be selected by the technical service and tested.
- 2.7. Additional requirements for dual-fuel engines
In order to receive an EU type-approval of a dual-fuel engine type or engine family, the manufacturer shall:
 - (a) conduct the tests in accordance with Table 1.3 of Appendix 1;
 - (b) in addition to the requirements set out in section 2, demonstrate that the dual-fuel engines are subject to the tests and comply with the requirements set out in Annex VIII.



Appendix 1

Summary of approval process for natural gas and LPG fuelled engines including dual-fuel engines

Tables 1.1 to 1.3 show a summary of the approval process for of natural gas fuelled engines and LPG fuelled engines and of the minimum number of tests required for approval of dual-fuel engines.

Table 1.1

EU type-approval of natural gas fuelled engines

	Point 2.3: Requirements for an universal fuel range engine	Number of test runs	Calculation of 'r'	Point 2.4: Requirements for a restricted fuel range engine	Number of test runs	Calculation of 'r'
Refer to point 2.3.1. NG-engine adaptable to any fuel composition	G _R (1) and G ₂₅ (2) At manufacturer's request engine may be tested on an additional market fuel (3), if S ₁ = 0,89 – 1,19	2 (max. 3)	$r = \frac{\text{fuel 2}(G_{25})}{\text{fuel 1}(G_R)}$ and, if tested with an additional fuel; $r_a = \frac{\text{fuel 2}(G_{25})}{\text{fuel 3}(\text{market fuel})}$ and $r_b = \frac{\text{fuel 1}(G_R)}{\text{fuel 3}(G_{23} \text{ or market fuel})}$			
Refer to point 2.3.2. NG-engine which is self-adaptive by a switch	G _R (1) and G ₂₃ (3) for H and G ₂₅ (2) and G ₂₃ (3) for L At manufacturer's request engine may be tested on a market fuel (3) instead of G ₂₃ , if S ₁ = 0,89 – 1,19	2 for the H-range, and 2 for the L-range; at respective position of switch	$r_b = \frac{\text{fuel 1}(G_R)}{\text{fuel 3}(G_{23} \text{ or market fuel})}$ and $r_a = \frac{\text{fuel 2}(G_{25})}{\text{fuel 3}(G_{23} \text{ or market fuel})}$			
Refer to point 2.4.1. NG-engine laid out for operation on either H-range gas or L-range gas				G _R (1) and G ₂₃ (3) for H or G ₂₅ (2) and G ₂₃ (3) for L At manufacturer's request engine may be tested on a market fuel (3) instead of G ₂₃ , if S ₁ = 0,89 – 1,19	2 for the H-range or 2 for the L-range 2	$r_b = \frac{\text{fuel 1}(G_R)}{\text{fuel 3}(G_{23} \text{ or market fuel})}$ for the H-range or $r_a = \frac{\text{fuel 2}(G_{25})}{\text{fuel 3}(G_{23} \text{ or market fuel})}$ for the L-range

▼B

	Point 2.3: Requirements for an universal fuel range engine	Number of test runs	Calculation of 'r'	Point 2.4: Requirements for a restricted fuel range engine	Number of test runs	Calculation of 'r'
Refer to point 2.4.2. NG-engine laid out for operation on one specific fuel composition				G _R (1) and G ₂₅ (2), Fine-tuning between the tests allowed. At manufac- turer's request engine may be tested on: G _R (1) and G ₂₃ (3) for H or G ₂₅ (2) and G ₂₃ (3) for L	2 2 for the H-range or 2 for the L-range	

Table 1.2

EU type-approval of LPG fuelled engines

	Point 2.3: Requirements for an universal fuel range engine	Number of test runs	Calculation of 'r'	Point 2.4: Requirements for a restricted fuel range engine	Number of test runs	Calculation of 'r'
Refer to point 2.3.4. LPG-engine adaptable to any fuel composition	Fuel A and fuel B	2	$r = \frac{\text{fuel B}}{\text{fuel A}}$			
Refer to point 2.4.2. LPG-engine laid out for operation on one specific fuel composition				Fuel A and fuel B, fine-tuning between the tests allowed	2	

Table 1.3

Minimum number of tests required for EU type-approval of dual-fuel engines

Dual-fuel type	Liquid-fuel mode	Dual-fuel mode			
		CNG	LNG	LNG ₂₀	LPG
1A		Universal or restricted (2 tests)	Universal (2 tests)	Fuel-specific (1 test)	Universal or restricted (2 tests)
1B	Universal (1 test)	Universal or restricted (2 tests)	Universal (2 tests)	Fuel-specific (1 test)	Universal or restricted (2 tests)

▼B

Dual-fuel type	Liquid-fuel mode	Dual-fuel mode			
		CNG	LNG	LNG ₂₀	LPG
2A		Universal or restricted (2 tests)	Universal (2 tests)	Fuel-specific (1 test)	Universal or restricted (2 tests)
2B	Universal (1 test)	Universal or restricted (2 tests)	Universal (2 tests)	Fuel-specific (1 test)	Universal or restricted (2 tests)
3B	Universal (1 test)	Universal or restricted (2 tests)	Universal (2 tests)	Fuel-specific (1 test)	Universal or restricted (2 tests)

▼B*ANNEX II***Arrangements with regard to conformity of production****1. Definitions**

For the purposes of this Annex the following definitions shall apply:

- 1.1. 'quality management system' means a set of interrelated or interacting elements that organisations use to direct and control how quality policies are implemented and quality objectives are achieved;
- 1.2. 'audit' means an evidence-gathering process used to evaluate how well audit criteria are being applied; it should be objective, impartial and independent, and the audit process should be both systematic and documented;
- 1.3. 'corrective actions' means a problem-solving process with subsequent steps taken to remove the causes of a nonconformity or undesirable situation and designed to prevent their recurrence;

2. Purpose

- 2.1. The conformity of production arrangements aim to ensure that each engine is in conformity with the specification, performance and marking requirements of the approved engine type or engine family.
- 2.2. Procedures include, inseparably, the assessment of quality management systems, referred as 'initial assessment' and set out in section 3 and verification and production-related controls, referred to as 'product conformity arrangements' and set out in section 4.

3. Initial assessment

- 3.1. Before granting EU type-approval, the approval authority shall verify the existence of satisfactory arrangements and procedures established by the manufacturer for ensuring effective control so that engines when in production conform to the approved engine type or engine family.
- 3.2. Guidelines for quality and/or environmental management systems auditing set out in the EN ISO 19011:2011 standard shall apply to the initial assessment.
- 3.3. The approval authority shall be satisfied with the initial assessment and the product conformity arrangements in section 4 taking account as necessary of one of the arrangements described in points 3.3.1 to 3.3.3 or a combination of those arrangements in full or in part as appropriate.
 - 3.3.1. The initial assessment and/or verification of product conformity arrangements shall be carried out by the approval authority granting the approval or an appointed body acting on behalf of the approval authority.
 - 3.3.1.1. When considering the extent of the initial assessment to be carried out, the approval authority may take account of available information relating to the manufacturer's certification which has not been accepted under point 3.3.3.

▼M2

- 3.3.2. The initial assessment and verification of product conformity arrangements may also be carried out in cooperation with the approval authority of another Member State, or the appointed body designated for this purpose by the approval authority.

▼B

- 3.3.2.1. In such a case, the approval authority of the other Member State shall prepare a statement of compliance outlining the areas and production facilities it has covered as relevant to the engines to be EU type-approved.
- 3.3.2.2. On receiving an application for a compliance statement from the approval authority of a Member State granting EU type-approval, the approval authority of another Member State shall send forthwith the statement of compliance or advise that it is not in a position to provide such a statement.
- 3.3.2.3. The statement of compliance shall include at least the following:
- 3.3.2.3.1. group or company (e.g. XYZ manufacturing);
- 3.3.2.3.2. particular organisation (e.g. European division);
- 3.3.2.3.3. plants/sites (e.g. engine plant 1 (United Kingdom) — engine plant 2 (Germany));
- 3.3.2.3.4. engine types/engine families included
- 3.3.2.3.5. areas assessed (e.g. engine assembly, engine testing, after-treatment manufacture)
- 3.3.2.3.6. documents examined (e.g. company and site quality manual and procedures);
- 3.3.2.3.7. date of the assessment (e.g. audit conducted from 18 to 30.5.2013);
- 3.3.2.3.8. planned monitoring visit (e.g. October 2014).
- 3.3.3. The approval authority shall also accept the manufacturer's suitable certification to harmonised standard EN ISO 9001:2008 or an equivalent harmonised standard as satisfying the initial assessment requirements of point 3.3. The manufacturer shall provide details of the certification and undertake to inform the approval authority of any revisions to its validity or scope.

4. Product conformity arrangements

- 4.1. Every engine EU type-approved pursuant to Regulation (EU) 2016/1628, this Delegated Regulation, Delegated Regulation (EU) 2017/655 and Implementing Regulation (EU) 2017/656 shall be so manufactured as to conform to the approved engine type or engine family by meeting the requirements of this Annex, Regulation (EU) 2016/1628 and the abovementioned Delegated and Implementing Regulations.
- 4.2. Before granting a EU type-approval pursuant to Regulation (EU) 2016/1628 and the delegated and implementing acts adopted pursuant to that Regulation, the approval authority shall verify the existence of adequate arrangements and documented control plans, to be agreed with the manufacturer for each approval, to carry out at specified intervals those tests or associated checks necessary to verify continued conformity with the approved engine type or engine family, including, where applicable, tests specified in Regulation (EU) 2016/1628 and the delegated and implementing acts adopted pursuant to that Regulation.

▼ B

- 4.3. The holder of the EU type-approval shall:
- 4.3.1. ensure the existence and application of procedures for effective control of the conformity of engines to the approved engine type or engine family;
 - 4.3.2. have access to the testing or other appropriate equipment necessary for checking conformity to each approved engine type or engine family;
 - 4.3.3. ensure that test or check result data are recorded and that annexed documents remain available for a period of up to 10 years to be determined in agreement with the approval authority;
 - 4.3.4. for engine categories NRSh and NRS, except for NRS-v-2b and NRS-v-3, ensure that for each type of engine, at least the checks and the tests prescribed in Regulation (EU) 2016/1628 and the delegated and implementing acts adopted pursuant to that Regulation are carried out. For other categories tests at a component or assembly of components level with appropriate criterion may be agreed between the manufacturer and the approval authority.
 - 4.3.5. analyse the results of each type of test or check, in order to verify and ensure the stability of the product characteristics, making allowance for variation in industrial production;
 - 4.3.6. ensure that any set of samples or test pieces giving evidence of non-conformity in the type of test in question gives rise to a further sampling and test or check.
- 4.4. If the further audit or check results referred to in point 4.3.6 are deemed not to be satisfactory in the opinion of the approval authority, the manufacturer shall ensure that conformity of production is restored as soon as possible by corrective actions to the satisfaction of the approval authority.
5. **Continued verification arrangements**
- 5.1. The authority which has granted EU type-approval may at any time verify the conformity of production control methods applied in each production facility by means of periodic audits. The manufacturer shall for that purpose allow access to the manufacture, inspection, testing, storage and distribution sites and shall provide all necessary information with regard to the quality management system documentation and records.
 - 5.1.1. The normal approach for such periodic audits shall be to monitor the continued effectiveness of the procedures laid down in sections 3 and 4 (initial assessment and product conformity arrangements).
 - 5.1.1.1. Surveillance activities carried out by the technical services (qualified or recognised as required in point 3.3.3) shall be accepted as satisfying the requirements of point 5.1.1 with regard to the procedures established at initial assessment.

▼B

- 5.1.1.2. The minimum frequency of verifications (other than those referred to in point 5.1.1.1) to ensure that the relevant conformity of production controls applied in accordance with sections 3 and 4 are reviewed over a period consistent with the climate of trust established by the approval authority shall be at least once every two years. However, additional verifications shall be carried out by the approval authority depending on the yearly production, the results of previous evaluations, the need to monitor corrective actions and upon a reasoned request from another approval authority or any market surveillance authority.
- 5.2. At every review, the records of tests, checks and production records, and in particular the records of those tests or checks documented as required in point 4.2, shall be available to the inspector.
- 5.3. The inspector may select random samples to be tested in the manufacturer's laboratory or in the facilities of the technical service, in which case only physical tests shall be carried out. The minimum number of samples may be determined according to the results of the manufacturer's own verification.
- 5.4. Where the level of control appears unsatisfactory, or when it seems necessary to verify the validity of the tests carried out in application of point 5.2, or upon a reasoned request from another approval authority or any market surveillance authority, the inspector shall select samples to be tested in the manufacturer's laboratory or sent to the technical service to perform physical tests in accordance with the requirements set out in section 6, in Regulation (EU) 2016/1628 and in the delegated and implementing acts adopted pursuant to that Regulation.
- 5.5. Where unsatisfactory results are found by the approval authority during an inspection or a monitoring review, or by an approval authority in other Member State, in accordance with Article 39(3) of Regulation (EU) 2016/1628, the approval authority shall ensure that all necessary steps are taken to restore conformity of production as rapidly as possible.
- 6. Conformity of production test requirements in cases of an unsatisfactory level of product conformity control as referred to in point 5.4.**
- 6.1. In case of an unsatisfactory level of product conformity control as referred to in point 5.4 or point 5.5, conformity of production shall be checked by emissions testing on the basis of the description in the EU type-approval certificates set out in Annex IV to Implementing Regulation (EU) 2017/656.
- 6.2. Except otherwise provided in point 6.3, the following procedure shall apply:
- 6.2.1. Three engines and, if applicable, three after-treatment systems shall randomly be taken for inspection from the series production of the engine type under consideration. Additional engines shall be taken as necessary to reach a pass or fail decision. For reaching a pass decision, a minimum of four engines needs to be tested.
- 6.2.2. After the inspector's selection of the engines, the manufacturer shall not carry out any adjustment to the engines selected.

▼ B

- 6.2.3. Engines shall be subjected to emissions testing in accordance with the requirements of Annex VI, or, in the case of dual fuel engines, in accordance with Appendix 2 of Annex VIII, and shall be subject to the test cycles relevant for the engine type in accordance with Annex XVII.

▼ M2

- 6.2.3.1. Notwithstanding point 6.2.3, in the case of engines of category RLL where an existing test report is used for type-approval in accordance with Article 7(2) of Implementing Regulation (EU) 2017/656, the per cent load and power and the weighting factor for the mode number of the test cycle type F for the purpose of this Annex may be the same as that used for the type-approval test.

▼ B

- 6.2.4. The limit values shall be those set out in Annex II to Regulation (EU) 2016/1628. Where an engine with after-treatment regenerates infrequently as referred to in point 6.6.2 of Annex VI, each gaseous or particulate pollutant emission result shall be adjusted by the factor applicable to the engine type. In all cases each gaseous or particulate pollutant emission result shall be adjusted by application of the appropriate deterioration factors (DFs) for that engine type ► **M2** that were determined in accordance with Annex III ◀.

- 6.2.5. The tests shall be carried out on newly manufactured engines.

- 6.2.5.1. At the request of the manufacturer, the tests may be conducted on engines which have been run-in, up either 2 % of the emission durability period or, if this is a shorter period of time, 125 hours. Where the run-in procedure shall be conducted by the manufacturer who shall undertake not to make any adjustments to those engines. Where the manufacturer has specified a run-in procedure in point 3.3 of the information document, as set out in Annex I to Implementing Regulation (EU) 2017/656, the run-in shall be conducted using that procedure.

- 6.2.6. On the basis of tests of the engine by sampling as set out in Appendix 1, the series production of the engines under consideration is regarded as conforming to the approved type where a pass decision is reached for all the pollutants and as non-conforming to the approved type where a fail decision is reached for one pollutant, in accordance with the test criteria applied in Appendix 1, and as shown in Figure 2.1.

- 6.2.7. When a pass decision has been reached for one pollutant, this decision may not be changed as a consequence of a result from any additional tests made in order to reach a decision for the other pollutants.

If a pass decision is not reached for all the pollutants and no fail decision is reached for any of the pollutant, a test shall be carried out on another engine.

- 6.2.8. If no decision is reached, the manufacturer may at any time decide to stop testing. In that case a fail decision shall be recorded.

- 6.3. By derogation from point 6.2.1, the following procedure shall apply for engine types with a sales volume within the EU of less than 100 units per year:

- 6.3.1. One engine and, if applicable, one after-treatment system shall be taken randomly for inspection from the series production of the engine type under consideration.

- 6.3.2. If the engine meets the requirements outlined in point 6.2.4, a pass decision is reached and no further test is necessary.

- 6.3.3. If the test does not satisfy the requirements outlined in point 6.2.4, the procedure outlined in points 6.2.6 to 6.2.9 shall be followed.

▼ B

6.4. All these tests may be conducted with the applicable market fuels. However, at the manufacturer's request, the reference fuels described in Annex IX shall be used. ► **M2** For engines fuelled with natural gas/biomethane (NG) or liquefied petroleum gas (LPG), including dual-fuel engines, the tests shall be performed with at least two of the reference fuels for each gaseous-fuelled engine, except in the case of a gaseous-fuelled engine with a fuel-specific type-approval where only one reference fuel is required, as described in Appendix 1 to Annex I. ◀ Where more than one gaseous reference fuel is used the results shall demonstrate that the engine meets the limit values with each fuel.

6.5. Non-compliance of gaseous-fuelled engines

In the case of dispute concerning compliance of gaseous-fuelled engines, including dual-fuel engines, when using a market fuel, the tests shall be performed with each reference fuel on which the parent engine has been tested, and, at the request of the manufacturer, with the possible additional third fuel, as referred to in points 2.3.1.1.1, 2.3.2.1 and 2.4.1.2 of Annex I, on which the parent engine may have been tested. When applicable, the result shall be converted by a calculation, applying the relevant factors ' r ', ' r_a ' or ' r_b ' as described in points 2.3.3, 2.3.4.1 and 2.4.1.3 of Annex I. If r , r_a or r_b are less than 1, no correction shall take place. The measured results and, when applicable, the calculated results shall demonstrate that the engine meets the limit values with all relevant fuels (for example fuels 1, 2 and, if applicable, the third fuel in the case of natural gas/biomethane engines, and fuels A and B in the case of LPG engines).

Figure 2.1

Schematic of production conformity testing

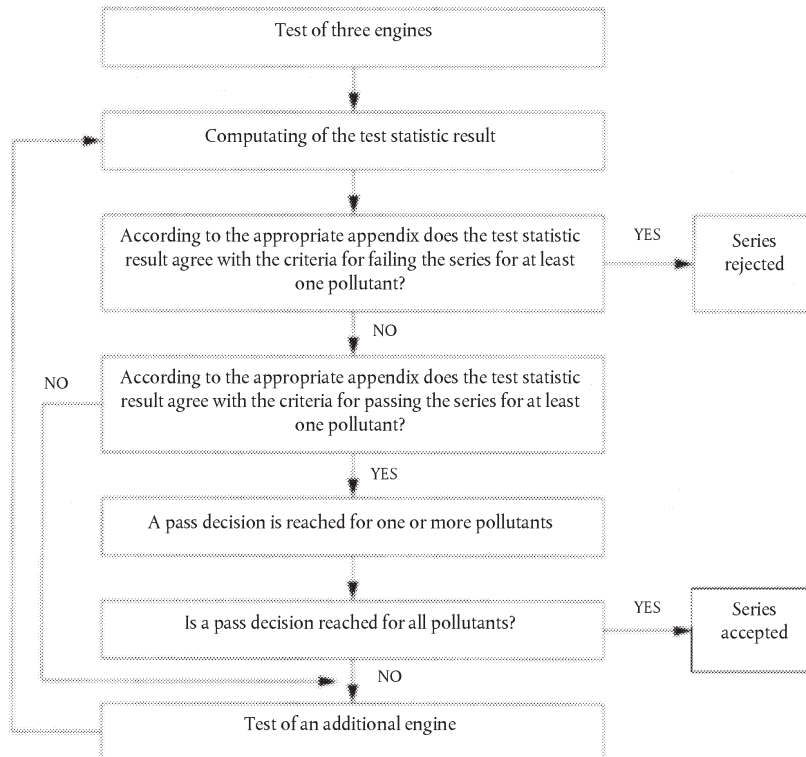



Appendix 1

Procedure for production conformity testing

1. This appendix describes the procedure to be used to verify production conformity for the emissions of pollutants.
2. With a minimum sample size of three engines, the sampling procedure shall be set out so that the probability of a lot passing a test with 30 % of the engines defective is 0,90 (producer's risk = 10 %) while the probability of a lot being accepted with 65 % of the engines defective is 0,10 (consumer's risk = 10 %).
3. The following procedure is used for each of the emission pollutants (see Figure 2.1):

Let: n = the current sample number.

4. Determine for the sample the test statistic quantifying the cumulative number of nonconforming tests at the n^{th} test.
5. Then:
 - (a) If the test statistic is less than or equal to the pass decision number for the sample size given in Table 2.1, a pass decision shall be reached for the pollutant;
 - (b) If the test statistic is greater than or equal to the fail decision number for the sample size given in Table 2.1, a fail decision shall be reached for the pollutant;
 - (c) Otherwise, an additional engine is tested in accordance with point 6.2 and the calculation procedure shall be applied to the sample increased by one more unit.

In Table 2.1 the pass and fail decision numbers shall be calculated by means of the International Standard ISO 8422/1991.

Table 2.1

Test statistics for production conformity testing

Minimum sample size: 3

Minimum sample size for pass decision: 4

Cumulative number of engines tested (sample size)	Pass decision number	Fail decision number
3	—	3
4	0	4
5	0	4
6	1	5
7	1	5
8	2	6
9	2	6

▼B

Cumulative number of engines tested (sample size)	Pass decision number	Fail decision number
10	3	7
11	3	7
12	4	8
13	4	8
14	5	9
15	5	9
16	6	10
17	6	10
18	7	11
19	8	9

▼B*ANNEX III***Methodology for adapting the emission laboratory test results to include the deterioration factors****1. Definitions**

For the purposes of this Annex, the following definitions apply:

- 1.1. 'Ageing cycle' means the non-road mobile machinery or engine operation (speed, load, power) to be executed during the service accumulation period.
- 1.2. 'Critical emission-related components' means the exhaust after-treatment system, the electronic engine control unit and its associated sensors and actuators, and the exhaust gas recirculation (EGR) including all related filters, coolers, control valves and tubing.
- 1.3. 'Critical emission-related maintenance' means the maintenance to be performed on critical emission-related components of the engine.
- 1.4. 'Emission-related maintenance' means the maintenance which substantially affects emissions or which is likely to affect emissions performance of the non-road mobile machinery or the engine during normal in-use operation.
- 1.5. 'Engine-after-treatment system family' means a manufacturer's grouping of engines that comply with the definition of engine family, but which are further grouped into a family of engine families utilising a similar exhaust after-treatment system.
- 1.6. 'Non-emission-related maintenance' means maintenance which does not substantially affect emissions and which does not have a lasting effect on the emissions performance deterioration of the non-road mobile machinery or the engine during normal in-use operation once the maintenance is performed.
- 1.7. 'Service accumulation schedule' means the ageing cycle and the service accumulation period for determining the deterioration factors for the engine-after-treatment system family.

2. General

- 2.1. This Annex details the procedures for selecting engines to be tested over a service accumulation schedule for the purpose of determining deterioration factors for engine type or engine family EU type-approval and conformity of production assessments. The deterioration factors shall be applied to the emissions measured in accordance with Annex VI and calculated in accordance with Annex VII in accordance with the procedure set out in point 3.2.7 or point 4.3, respectively.
- 2.2. The service accumulation tests or the emissions tests performed to determine deterioration need not be witnessed by the approval authority.

▼ B

2.3. This Annex also details the emission-related and non-emission-related maintenance that should be or may be carried out on engines undergoing a service accumulation schedule. Such maintenance shall conform to the maintenance performed on in-service engines and communicated to the end-users of new engines.

3. **Engine categories NRE, NRG, IWP, IWA, RLL, RLR, SMB, ATS and sub-categories NRS-v-2b and NRS-v-3**

3.1. Selection of engines for establishing emission durability period deterioration factors

3.1.1. Engines shall be selected from the engine family defined in section 2 of Annex IX to Implementing Regulation (EU) 2017/656 for emission testing to establish emission durability period deterioration factors.

▼ M2

3.1.2. Engines from different engine families may be further combined into families based on the type of exhaust after-treatment system utilised or where no after-treatment is used, based upon the similarity of the technical characteristics of the emission control system. Engines of different bore and stroke, different configuration, different air management systems or different fuel systems may be considered equivalent in respect to emissions deterioration characteristics if the manufacturer provides data to the approval authority that there is a reasonable technical basis for such determination. In order to place engine families having similar technical specifications and installation for the exhaust after-treatment systems into the same engine after-treatment system family, the manufacturer shall provide data to the approval authority that demonstrates that the emissions reduction performance of such engines is similar.

3.1.3. The test engine shall represent the emission deterioration characteristics of the engine families that will apply the resulting deterioration factors for type approval. The engine manufacturer shall select one engine representing the engine family, group of engine families or engine-after-treatment system family, as determined in accordance with point 3.1.2, for testing over the service accumulation schedule referred to in point 3.2.2, which shall be reported to the approval authority before any testing commences.

3.1.4. If the approval authority decides that the worst case emissions of the engine family, group of engine families or engine-after-treatment system family can be better characterised by another test engine, the test engine to be used shall be selected jointly by the approval authority and the engine manufacturer.

▼ B

3.2. Determination of emission durability period deterioration factors

▼ M2

3.2.1. General

Deterioration factors applicable to an engine family, group of engine families or an engine-after-treatment system family shall be developed from the selected engines based on a service accumulation schedule that includes periodic testing for gaseous and particulate emissions over each test cycle applicable to the engine category, as given in Annex IV to Regulation (EU) 2016/1628. In the case of non-road transient test cycles for engines of category NRE ('NRTC'), only the results of the hot-start run of the NRTC ('hot-start NRTC') shall be used.

▼B

- 3.2.1.1. At the request of the manufacturer, the approval authority may allow the use of deterioration factors that have been established using alternative procedures to those specified in points 3.2.2 to 3.2.5. In that case, the manufacturer shall demonstrate to the satisfaction of the approval authority that the alternative procedures used are not less rigorous than those set out in points 3.2.2 to 3.2.5.
- 3.2.2. Service accumulation schedule
- Service accumulation schedules may be carried out at the choice of the manufacturer by running a non-road mobile machinery equipped with the selected engine over an 'in-service' accumulation schedule or by running the selected engine over a 'dynamometer service' accumulation schedule. The manufacturer shall not be required to use reference fuel for the service accumulation in-between emission measurement test points.
- 3.2.2.1. In-service and dynamometer service accumulation
- 3.2.2.1.1. The manufacturer shall determine the form and duration of the service accumulation and the ageing cycle for engines in a manner consistent with good engineering judgment.
- 3.2.2.1.2. The manufacturer shall determine the test points where gaseous and particulate emissions will be measured over the applicable cycles, as follows:
- 3.2.2.1.2.1. When running a service accumulation schedule shorter than the emission durability period in accordance with point 3.2.2.1.7, the minimum number of test points shall be three, one at the beginning, one approximately in the middle and one at the end of the service accumulation schedule.
- 3.2.2.1.2.2. When completing the service accumulation up to the end of the emission durability period, the minimum number of test points shall be two, one at the beginning and one at the end of the service accumulation.
- 3.2.2.1.2.3. The manufacturer may additionally test at evenly spaced intermediate points.
- 3.2.2.1.3. The emission values at the start point and at the emission durability period endpoint either calculated in accordance with point 3.2.5.1 or measured directly in accordance with point 3.2.2.1.2.2, shall be within the limit values applicable to the engine family. However individual emission results from the intermediate test points may exceed those limit values.
- 3.2.2.1.4. For engine categories or sub-categories to which a NRTC applies, or for engines category or sub-categories NRS to which a large spark-ignition engines non-road transient test cycles ('LSI-NRTC') applies, the manufacturer may request the agreement of the approval authority to run only one test cycle (either the hot-start NRTC or LSI-NRTC, as applicable, or NRSC) at each test point, and to run the other test cycle only at the beginning and at the end of the service accumulation schedule.
- 3.2.2.1.5. In the case of engine categories or sub-categories for which there is no applicable non-road transient cycle given in Annex IV to Regulation (EU) 2016/1628, only the NRSC shall be run at each test point.
- 3.2.2.1.6. Service accumulation schedules may be different for different engine-after-treatment system families.

▼B

- 3.2.2.1.7. Service accumulation schedules may be shorter than the emission durability period, but shall not be shorter than the equivalent of at least one quarter of the relevant emission durability period specified in Annex V to Regulation (EU) 2016/1628.
- 3.2.2.1.8. Accelerated ageing by adjusting the service accumulation schedule on a fuel consumption basis is permitted. The adjustment shall be based on the ratio between the typical in-use fuel consumption and the fuel consumption on the ageing cycle, but fuel consumption on the ageing cycle shall not exceed typical in-use fuel consumption by more than 30 %.
- 3.2.2.1.9. The manufacturer may use, if agreed by the approval authority, alternative methods of accelerated ageing.
- 3.2.2.1.10. The service accumulation schedule shall be fully described in the application for EU type-approval and reported to the approval authority before the start of any testing.
- 3.2.2.2. If the approval authority decides that additional measurements need to be performed between the points selected by the manufacturer it shall notify the manufacturer. The revised service accumulation schedule shall be prepared by the manufacturer and agreed by the approval authority.
- 3.2.3. Engine testing
- 3.2.3.1. Engine stabilisation
- 3.2.3.1.1. For each engine-after-treatment system family, the manufacturer shall determine the number of hours of non-road mobile machinery or engine running after which the operation of the engine-after-treatment system has stabilised. If requested by the approval authority the manufacturer shall make available the data and analysis used to make this determination. As an alternative, the manufacturer may run the engine or non-road mobile machinery between 60 and 125 hours or the equivalent time on the ageing cycle to stabilise the engine-after-treatment system.
- 3.2.3.1.2. The end of the stabilisation period determined in point 3.2.3.1.1 shall be deemed to be the start of the service accumulation schedule.
- 3.2.3.2. Service accumulation testing
- 3.2.3.2.1. After stabilisation, the engine shall be run over the service accumulation schedule selected by the manufacturer, as described in point 3.2.2. At the periodic intervals in the service accumulation schedule determined by the manufacturer, and, where applicable, decided by the approval authority in accordance with point 3.2.2.2, the engine shall be tested for gaseous and particulate emissions over the hot-start NRTC and NRSC, or LSI-NRTC and NRSC applicable to the engine category, as set out in Annex IV to Regulation (EU) 2016/1628.

The manufacturer may select to measure the pollutant emissions before any exhaust after-treatment system separately from the pollutant emissions after any exhaust after-treatment system.

In accordance with point 3.2.2.1.4, if it has been agreed that only one test cycle (hot-start NRTC, LSI-NRTC or NRSC) be run at each test point, the other test cycle (hot-start NRTC, LSI-NRTC or NRSC) shall be run at the beginning and at the end of the service accumulation schedule.

▼B

In accordance with point 3.2.2.1.5, in the case of engine categories or sub-categories for which there is no applicable non-road transient cycle given in Annex IV to Regulation (EU) 2016/1628, only the NRSC shall be run at each test point.

3.2.3.2.2. During the service accumulation schedule, maintenance shall be carried out on the engine in accordance with point 3.4.

3.2.3.2.3. During the service accumulation schedule, unscheduled maintenance on the engine or non-road mobile machinery may be performed, for example if the manufacturer's normal diagnostic system has detected a problem that would have indicated to the non-road mobile machinery operator that a fault had arisen.

3.2.4. Reporting

3.2.4.1. The results of all emission tests (hot-start NRTC, LSI-NRTC and NRSC) conducted during the service accumulation schedule shall be made available to the approval authority. If an emission test is declared to be void, the manufacturer shall provide reasons why the test has been declared void. In such a case, another series of emission tests shall be carried out within the following 100 hours of service accumulation.

3.2.4.2. The manufacturer shall retain records of all information concerning all the emission tests and maintenance carried out on the engine during the service accumulation schedule. This information shall be submitted to the approval authority along with the results of the emission tests conducted over the service accumulation schedule.

3.2.5. Determination of deterioration factors

3.2.5.1. When running a service accumulation schedule in accordance with point 3.2.2.1.2.1 or point 3.2.2.1.2.3, for each pollutant measured over the hot-start NRTC, LSI-NRTC and NRSC at each test point during the service accumulation schedule, a 'best fit' linear regression analysis shall be made on the basis of all test results. The results of each test for each pollutant shall be expressed to the same number of decimal places as the limit value for that pollutant, as applicable to the engine family, plus one additional decimal place.

Where in accordance with point 3.2.2.1.4 or point 3.2.2.1.5, only one test cycle (hot-start NRTC, LSI-NRTC or NRSC) has been run at each test point, the regression analysis shall be made only on the basis of the test results from the test cycle run at each test point.

The manufacturer may request the prior approval of the approval authority for a non-linear regression.

3.2.5.2. The emission values for each pollutant at the start of the service accumulation schedule and at the emission durability period end point that is applicable for the engine under test shall be either:

(a) determined by extrapolation of the regression equation in point 3.2.5.1, when running a service accumulation schedule in accordance with point 3.2.2.1.2.1 or point 3.2.2.1.2.3, or

(b) measured directly, when running a service accumulation schedule in accordance with point 3.2.2.1.2.2.

▼ **M2**

Where emission values are used for engine families in the same group of engine families or engine-after-treatment family but with different emission durability periods, then the emission values at the emission durability period end point shall be recalculated for each emission durability period by extrapolation or interpolation of the regression equation as determined in point 3.2.5.1.

▼ **B**

- 3.2.5.3. The deterioration factor (DF) for each pollutant is defined as the ratio of the applied emission values at the emission durability period end point and at the start of the service accumulation schedule (multiplicative deterioration factor).

The manufacturer may request the prior approval of the approval authority for the application of an additive DF for each pollutant may be applied. The additive DF is defined as the difference between the calculated emission values at the emission durability period end point and at the start of the service accumulation schedule.

An example for determination of DFs by using linear regression is shown in Figure 3.1 for NO_x emission.

Mixing of multiplicative and additive DFs within one set of pollutants is not permitted.

If the calculation results in a value of less than 1,00 for a multiplicative DF, or less than 0,00 for an additive DF, then the deterioration factor shall be 1,0 or 0,00, respectively.

In accordance with point 3.2.2.1.4, if it has been agreed that only one test cycle (hot-start NRTC, LSI-NRTC or NRSC) be run at each test point and the other test cycle (hot-start NRTC, LSI-NRTC or NRSC) run only at the beginning and end of the service accumulation schedule, the deterioration factor calculated for the test cycle that has been run at each test point shall be applicable also for the other test cycle.

Figure 3.1

Example of DF determination

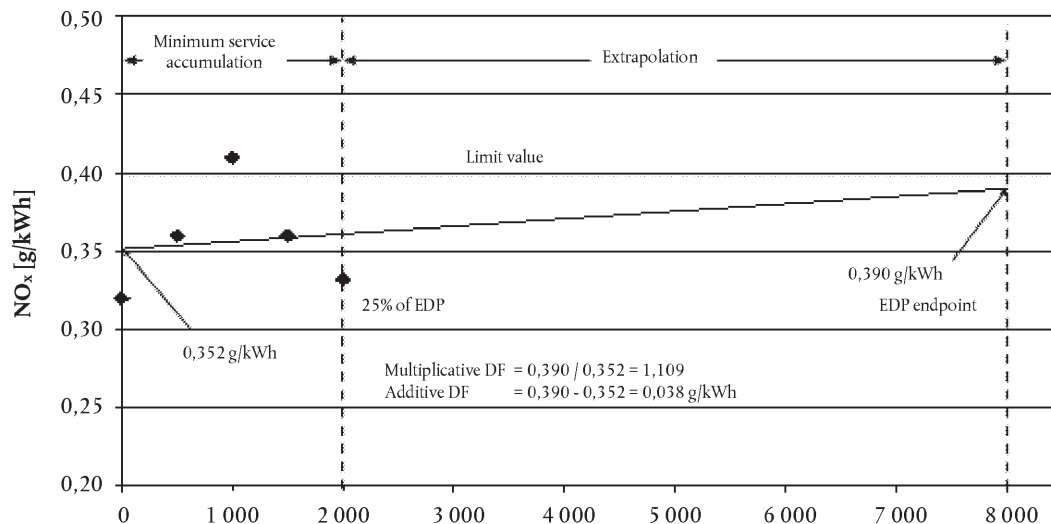

▼ B

- 3.2.6. Assigned deterioration factors
- 3.2.6.1. As an alternative to using a service accumulation schedule to determine DFs, engine manufacturers may select to use assigned multiplicative DFs, as given in Table 3.1.

Table 3.1

Assigned deterioration factors

Test cycle	CO	HC	NO _x	PM	PN
NRTC and LSI-NRTC	1,3	1,3	1,15	1,05	1,0
NRSC	1,3	1,3	1,15	1,05	1,0

Assigned additive DFs shall not be given. The assigned multiplicative DFs shall not be transformed into additive DFs.

▼ M2

- 3.2.6.1.1. Notwithstanding point 3.2.6.1, for PN, either an additive DF of 0,0 or a multiplicative DF of 1,0 may be used, in conjunction with the results of previous DF testing that did not establish a value for PN if both of the following conditions are fulfilled:

- (a) the previous DF test was conducted on engine technology that would have qualified for inclusion in the same engine after-treatment system family, as set out in point 3.1.2, as the engine family to which it is intended to apply the DFs; and,
- (b) the test results were used in a previous type-approval granted before the applicable EU type-approval date given in Annex III to Regulation (EU) 2016/1628.

▼ B

- 3.2.6.2. Where assigned DFs are used, the manufacturer shall present to the approval authority robust evidence that the emission control components can reasonably be expected to have the emission durability associated with those assigned factors. This evidence may be based upon design analysis, or tests, or a combination of both.

- 3.2.7. Application of deterioration factors

- 3.2.7.1. The engines shall meet the respective emission limits for each pollutant, as applicable to the engine family, after application of the deterioration factors to the test result as measured in accordance with Annex VI (cycle-weighted specific emission for particulate and each individual gas). Depending on the type of DF, the following provisions apply:

(a) Multiplicative: (cycle weighted specific emission) × DF ≤ emission limit

(b) Additive: (cycle weighted specific emission) + DF ≤ emission limit

Cycle weighted specific emission may include the adjustment for infrequent regeneration, where applicable.

▼ B

3.2.7.2. For a multiplicative NO_x + HC DF, separate HC and NO_x DFs shall be determined and applied separately when calculating the deteriorated emission levels from an emissions test result before combining the resultant deteriorated NO_x and HC values to establish compliance with the emission limit.

3.2.7.3. The manufacturer may carry across the DFs determined for an engine-after-treatment system family to an engine that does not fall into the same engine-after-treatment system family. In such cases, the manufacturer shall demonstrate to the approval authority that the engine for which the engine-after-treatment system family was originally tested and the engine for which the DFs are being carried across have similar technical specifications and installation requirements on the non-road mobile machinery and that the emissions of such engine are similar.

Where DFs are carried across to an engine with a different emission durability period, the DFs shall be recalculated for the applicable emission durability period by extrapolation or interpolation of the regression equation as determined in point 3.2.5.1.

3.2.7.4. The DF for each pollutant for each applicable test cycle shall be recorded in the test report set out in Appendix 1 of Annex VI to Implementing Regulation (EU) 2017/656.

3.3. Checking of conformity of production

3.3.1. Conformity of production for emissions compliance is checked on the basis of Section 6 of Annex II.

3.3.2. The manufacturer may measure the pollutant emissions before any exhaust after-treatment system at the same time as the EU type-approval test is being performed. For that purpose, the manufacturer may develop informal DFs separately for the engine without after-treatment system and for the after-treatment system that may be used by the manufacturer as an aid to end of production line auditing.

3.3.3. For the purposes of EU type-approval, only the DFs determined in accordance with point 3.2.5 or 3.2.6 shall be recorded in the test report set out in Appendix 1 of Annex VI to Implementing Regulation (EU) 2017/656.

3.4. Maintenance

For the purpose of the service accumulation schedule, maintenance shall be performed in accordance with the manufacturer's manual for service and maintenance.

3.4.1. Scheduled emission-related maintenance

3.4.1.1. Scheduled emission-related maintenance during engine running, undertaken for the purpose of conducting a service accumulation schedule, shall occur at equivalent intervals to those that are specified in the manufacturer's maintenance instructions to the end-user of the non-road mobile machinery or engine. This schedule maintenance may be updated as necessary throughout the service accumulation schedule provided that no maintenance operation is deleted from the maintenance schedule after the operation has been performed on the test engine.

▼ B

- 3.4.1.2. Any adjustment, disassembly, cleaning or exchange of critical emission-related components which is performed on a periodic basis within the emission durability period to prevent malfunction of the engine, shall only be done to the extent that is technologically necessary to ensure proper functioning of the emission control system. The need for scheduled exchange, within the service accumulation schedule and after a certain running time of the engine, of critical emission-related components other than those qualifying as routine exchange items shall be avoided. In this context, consumable maintenance items for regular renewal or items that require cleaning after a certain running time of the engine, shall qualify as routine exchange items.
- 3.4.1.3. Any scheduled maintenance requirements shall be subject to approval by the approval authority before an EU type-approval is granted and shall be included in the customer's manual. ► **M2** The approval authority shall not refuse to approve maintenance requirements that are reasonable and technically necessary, including but not limited to those identified in point 3.4.1.4. ◀
- 3.4.1.4. The engine manufacturer shall specify for the service accumulation schedules any adjustment, cleaning, maintenance (where necessary) and scheduled exchange of the following items:
- filters and coolers in the exhaust gas recirculation (EGR)
 - positive crankcase ventilation valve, if applicable
 - fuel injector tips (only cleaning is permitted)
 - fuel injectors
 - turbocharger
 - electronic engine control unit and its associated sensors and actuators
 - particulate after-treatment system (including related components)
 - NO_x after-treatment system (including related components)
 - exhaust gas recirculation (EGR), including all related control valves and tubing
 - any other exhaust after-treatment system.
- 3.4.1.5. Scheduled critical emission-related maintenance shall only be performed if it is required to be performed in-use and that requirement is communicated to the end-user of the engine or non-road mobile machinery.
- 3.4.2. Changes to scheduled maintenance
- The manufacturer shall submit a request to the approval authority for approval of any new scheduled maintenance that it wishes to perform during the service accumulation schedule and subsequently

▼B

to recommend to end-users of non-road mobile machinery and engines. The request shall be accompanied by data supporting the need for the new scheduled maintenance and the maintenance interval.

3.4.3. Non-emission-related scheduled maintenance

Non-emission-related scheduled maintenance which is reasonable and technically necessary (for example oil change, oil filter change, fuel filter change, air filter change, cooling system maintenance, idle speed adjustment, governor, engine bolt torque, valve lash, injector lash, adjustment of the tension of any drive-belt, etc.) may be performed on engines or non-road mobile machinery selected for the service accumulation schedule at the least frequent intervals recommended by the manufacturer to the end-user (for example not at the intervals recommended for severe service).

3.5. Repair

3.5.1. Repairs to the components of an engine selected for testing over a service accumulation schedule shall be performed only as a result of component failure or engine malfunction. Repair of the engine itself, the emission control system or the fuel system is not permitted except to the extent defined in point 3.5.2.

3.5.2. If the engine, its emission control system or its fuel system fails during the service accumulation schedule, the service accumulation shall be considered void, and a new service accumulation shall be started with a new engine.

The previous paragraph shall not apply when the failed components are replaced with equivalent components that have been subject to a similar number of hours of service accumulation.

4. **Engine categories and sub-categories NRSh and NRS, except for NRS-v-2b and NRS-v-3**

4.1. The applicable EDP category and corresponding deterioration factor (DF) shall be determined in accordance with this section 4.

4.2. An engine family shall be considered as compliant with the limit values required for an engine sub-category when the emissions test results of all engines representing the engine family, once adjusted by multiplication by the DF laid down in section 2, are lower than or equal to the limit values required for that engine sub-category. However, where one or more emission test results of one or more engines representing the engine family, once adjusted by multiplication by the DF laid down in section 2, are higher than one or more single emission limit values required for that engine sub-category, the engine family shall be considered not compliant with the limit values required for that engine sub-category.

4.3. DFs shall be determined as follows:

4.3.1. On at least one test engine representing the configuration chosen to be the most likely to exceed HC + NO_x emission limits, and constructed to be representative of production engines, the (full) test procedure emission testing shall be conducted as described in Annex VI after the number of hours representing stabilised emissions.

▼B

- 4.3.2. If more than one engine is tested, the results shall be calculated as the average of the results for all the engines tested, rounded to the same number of decimal places as in the applicable limit, expressed to one additional significant figure.
- 4.3.3. Such emission testing shall be conducted again following ageing of the engine. The ageing procedure should be designed to allow the manufacturer to appropriately predict the in-use emission deterioration expected over the EDP of the engine, taking into account the type of wear and other deterioration mechanisms expected under typical consumer use which could affect emissions performance. If more than one engine is tested, the results shall be calculated as the average of the results for all the engines tested, rounded to the same number of decimal places contained in the applicable limit, expressed to one additional significant figure.
- 4.3.4. The emissions at the end of the EDP (average emissions, if applicable) for each regulated pollutant shall be divided by the stabilised emissions (average emissions, if applicable) and rounded to two significant figures. The resulting number shall be the DF, unless it is less than 1,00, in which case the DF shall be 1,00.
- 4.3.5. The manufacturer may schedule additional emission test points between the stabilised emission test point and the end of the EDP. If intermediate tests are scheduled, the test points shall be evenly spaced over the EDP (plus or minus two hours) and one such test point shall be at one half of full EDP (plus or minus two hours).
- 4.3.6. For each pollutant HC + NO_x and CO, a straight line must be fitted to the data points treating the initial test as occurring at hour zero, and using the method of least-squares. The DF is the calculated emission at the end of the durability period divided by the calculated emission at zero hours.

The DF for each pollutant for the applicable test cycle shall be recorded in the test report set out in Appendix 1 of Annex VII to Implementing Regulation (EU) 2017/656.

- 4.3.7. Calculated deterioration factors may cover families in addition to the one on which they were generated if the manufacturer submits a justification acceptable to the approval authority in advance of EU type-approval that the affected engine families can be reasonably expected to have similar emission deterioration characteristic based on the design and technology used.

A non-exclusive list of design and technology groupings is given below:

- conventional two-stroke engines without after-treatment system,
- conventional two-stroke engines with a catalyst of the same active material and loading, and the same number of cells per cm²,
- stratified scavenging two-stroke engines,

▼ B

- stratified scavenging two-stroke engines with a catalyst of the same active material and loading, and the same number of cells per cm²,
- four-stroke engines with catalyst with same valve technology and identical lubrication system,
- four-stroke engines without catalyst with the same valve technology and identical lubrication system.

4.4. EDP categories

- 4.4.1. For those engine categories in Table V-3 or V-4 of Annex V to Regulation (EU) 2016/1628 that have alternative values for EDP, manufacturers shall declare the applicable EDP category for each engine family at the time of EU type-approval. Such category shall be the category from Table 3.2 which most closely approximates the expected useful lives of the equipment into which the engines are expected to be installed as determined by the engine manufacturer. Manufacturers shall retain data appropriate to support their choice of EDP category for each engine family. Such data shall be supplied to the approval authority upon request.

Table 3.2

EDP categories

EDP Category	Application of Engine
Cat 1	Consumer products
Cat 2	Semi-professional products
Cat 3	Professional products

- 4.4.2. The manufacturer shall demonstrate to the satisfaction of the approval authority that the declared EDP category is appropriate. Data to support a manufacturer's choice of EDP category, for a given engine family, may include but are not limited to:
- surveys of the life spans of the equipment in which the subject engines are installed,
 - engineering evaluations of field aged engines to ascertain when engine performance deteriorates to the point where usefulness and/or reliability is impacted to a degree sufficient to necessitate overhaul or replacement,
 - warranty statements and warranty periods,
 - marketing materials regarding engine life,
 - failure reports from engine customers, and
 - engineering evaluations of the durability, in hours, of specific engine technologies, engine materials or engine designs.

*ANNEX IV***Requirements with regard to emission control strategies, NO_x control measures and particulate control measures****1. Definitions abbreviations and general requirements**

1.1. For the purposes of this Annex, the following definitions and abbreviations apply:

- (1) ‘diagnostic trouble code (“DTC”)’ means a numeric or alpha-numeric identifier which identifies or labels a NCM and/ PCM;
- (2) ‘confirmed and active DTC’ means a DTC that is stored during the time the NCD and/or PCD system concludes that a malfunction exists;
- (3) ‘NCD engine family’ means a manufacturer's grouping of engines having common methods of monitoring/diagnosing NCMs;
- (4) ‘NO_x Control Diagnostic system (NCD)’ means a system on-board the engine which has the capability of
 - (a) detecting a NO_x Control Malfunction,
 - (b) identifying the likely cause of NO_x control malfunctions by means of information stored in computer memory and/or communicating that information off-board;
- (5) ‘NO_x Control Malfunction (NCM)’ means an attempt to tamper with the NO_x control system of an engine or a malfunction affecting that system that might be due to tampering, that is considered by this Regulation as requiring the activation of a warning or an inducement system once detected;
- (6) ‘Particulate Control Diagnostic system (PCD)’ means a system on-board the engine which has a capability of:
 - (a) detecting a Particulate Control Malfunction,
 - (b) identifying the likely cause of particulate control malfunctions by means of information stored in computer memory and/or communicating that information off-board;
- (7) ‘Particulate Control Malfunction (PCM)’ means an attempt to tamper with the particulate after-treatment system of an engine or a malfunction affecting the particulate after-treatment system that might be due to tampering, that is considered by this Regulation as requiring the activation of a warning once detected;
- (8) ‘PCD engine family’ means a manufacturer's grouping of engines having common methods of monitoring/diagnosing PCMs;
- (9) ‘Scan-tool’ means an external test equipment used for off-board communication with the NCD and/or PCD system.

▼ B

- 1.2. Ambient temperature
- Notwithstanding Article 2(7), where reference is made to ambient temperature in relation to environments other than a laboratory environment, the following provisions shall apply:
- 1.2.1. For an engine installed in a test-bed, ambient temperature shall be the temperature of the combustion air supplied to the engine, upstream of any part of the engine being tested.
- 1.2.2. For an engine installed in non-road mobile machinery, ambient temperature shall be the air temperature immediately outside the perimeter of the non-road mobile machinery.
2. **Technical requirements relating to emission control strategies**
- 2.1. This section 2 shall apply for electronically controlled engines of categories NRE, NRG, IWP, IWA, RLL and RLR, complying with 'Stage V' emission limits set out in Annex II to Regulation (EU) 2016/1628 and using electronic control to determine both the quantity and timing of injecting fuel or using electronic control to activate, de-activate or modulate the emission control system used to reduce NO_x.
- 2.2. Requirements for base emission control strategy
- 2.2.1. The base emission control strategy shall be designed as to enable the engine, in normal use, to comply with the provisions of this Regulation. Normal use is not restricted to the control conditions as specified in point 2.4.
- 2.2.2. Base emission control strategies are, but not limited to, maps or algorithms for controlling:
- (a) timing of fuel injection or ignition (engine timing);
- (b) exhaust gas recirculation (EGR);
- (c) SCR catalyst reagent dosing.
- 2.2.3. Any base emission control strategy that can distinguish engine operation between a standardised EU type-approval test and other operating conditions and subsequently reduce the level of emission control when not operating under conditions substantially included in the EU type-approval procedure is prohibited.

▼ M2

- 2.2.3.1. Notwithstanding point 2.2.3, in the case of engine (sub-)categories that are not subject to non-road transient test cycles for EU type-approval purposes, the base emission control strategy may identify when transient operating conditions occur and apply the corresponding emission control strategy. In this case, this emission control strategy shall be included in the overview of the base emission control strategy required by point 1.4 of Annex I to Implementing Regulation (EU) 2017/656 and in the confidential information on emission control strategy set out in Appendix 2 to that Annex.
- 2.2.4. The manufacturer shall demonstrate to the technical service at the time of the EU type-approval test that the operation of the base emission control strategy complies with the provisions of this section on the basis of the documentation referred to in point 2.6.

▼B

2.3. Requirements for auxiliary emission control strategy

▼M2

2.3.1. An auxiliary emission control strategy may be activated by an engine or a non-road mobile machinery, provided that the auxiliary emission control strategy:

▼B

2.3.1.1. does not permanently reduce the effectiveness of the emission control system;

2.3.1.2. operates only outside the control conditions specified in points 2.4.1, 2.4.2 or 2.4.3 for the purposes defined in point 2.3.5 and only as long as is needed for those purposes, except as permitted by points 2.3.1.3, 2.3.2 and 2.3.4;

2.3.1.3. is activated only exceptionally within the control conditions in points 2.4.1, 2.4.2 or 2.4.3, respectively, has been demonstrated to be necessary for the purposes identified in point 2.3.5 has been approved by the approval authority, and is not activated for longer than is needed for those purposes;

2.3.1.4. ensures a level of performance of the emission control system that is as close as possible to that provided by the base emission control strategy.

2.3.2. Where the auxiliary emission control strategy is activated during the EU type-approval test, activation shall not be limited to occur outside the control conditions set out in point 2.4, and the purpose shall not be limited to the criteria set out in point 2.3.5.

2.3.3. Where the auxiliary emission control strategy is not activated during the EU type-approval test, it must be demonstrated that the auxiliary emission control strategy is active only for as long as required for the purposes set out in point 2.3.5.

2.3.4. Cold temperature operation

An auxiliary emission control strategy may be activated on an engine equipped with exhaust gas recirculation (EGR) irrespective of the control conditions in point 2.4 if the ambient temperature is below 275 K (2 °C) and one of the two following criteria is met:

(a) intake manifold temperature is less than or equal to the temperature defined by the following equation: $IMT_c = P_{IM}/15,75 + 304,4$, where: IMT_c is the calculated intake manifold temperature, K and P_{IM} is the absolute intake manifold pressure in kPa;

(b) engine coolant temperature is less than or equal to the temperature defined by the following equation: $ECT_c = P_{IM}/14,004 + 325,8$, where: ECT_c is the calculated engine coolant temperature, K and P_{IM} is the absolute intake manifold pressure, kPa.

2.3.5. Except as permitted by point 2.3.2, an auxiliary emission control strategy may solely be activated for the following purposes:

(a) by on-board signals, for protecting the engine (including air-handling device protection) and/or non-road mobile machinery into which the engine is installed from damage;

(b) for operational safety reasons;

(c) for prevention of excessive emissions, during cold start or warming-up, during shut-down;

▼B

- (d) if used to trade-off the control of one regulated pollutant under specific ambient or operating conditions, for maintaining control of all other regulated pollutants, within the emission limit values that are appropriate for the engine concerned. The purpose is to compensate for naturally occurring phenomena in a manner that provides acceptable control of all emission constituents.
- 2.3.6. The manufacturer shall demonstrate to the technical service at the time of the EU type-approval test that the operation of any auxiliary emission control strategy complies with the provisions of this section. The demonstration shall consist of an evaluation of the documentation referred to in point 2.6.
- 2.3.7. Any operation of an auxiliary emission control strategy non-compliant with points 2.3.1 to 2.3.5 is prohibited.
- 2.4. Control conditions
- The control conditions specify an altitude, ambient temperature and engine coolant range that determines whether auxiliary emission control strategies may generally or only exceptionally be activated in accordance with point 2.3.
- The control conditions specify an atmospheric pressure which is measured as absolute atmospheric static pressure (wet or dry) ('Atmospheric pressure')
- 2.4.1. Control conditions for engines of categories IWP and IWA:
- (a) an altitude not exceeding 500 metres (or equivalent atmospheric pressure of 95,5 kPa);
 - (b) an ambient temperature within the range 275 K to 303 K (2 °C to 30 °C);
 - (c) the engine coolant temperature above 343 K (70 °C).
- 2.4.2. Control conditions for engines of category RLL:
- (a) an altitude not exceeding 1 000 metres (or equivalent atmospheric pressure of 90 kPa);
 - (b) an ambient temperature within the range 275 K to 303 K (2 °C to 30 °C);
 - (c) the engine coolant temperature above 343 K (70 °C).
- 2.4.3. Control conditions for engines of categories NRE, NRG and RLR:
- (a) the atmospheric pressure greater than or equal to 82,5 kPa;
 - (b) the ambient temperature within the following range:
 - equal to or above 266 K (– 7 °C),
 - less than or equal to the temperature determined by the following equation at the specified atmospheric pressure: $T_c = - 0,4514 \times (101,3 - P_b) + 311$, where: T_c is the calculated ambient air temperature, K and P_b is the atmospheric pressure, kPa;
 - (c) the engine coolant temperature above 343 K (70 °C).
- 2.5. Where the engine inlet air temperature sensor is being used to estimate ambient air temperature the nominal offset between the two measurement points shall be evaluated for an engine type or engine family. Where used, the measured intake air temperature shall be adjusted by an amount equal to the nominal offset to estimate ambient temperature for an installation using the specified engine type or engine family.

▼ B

The evaluation of the offset shall be made using good engineering judgement based on technical elements (calculations, simulations, experimental results, data etc.) including:

- (a) the typical categories of non-road mobile machinery into which the engine type or engine family will be installed; and,
- (b) the installation instructions provided to the OEM by the manufacturer.

A copy of the evaluation shall be made available to the approval authority upon request.

2.6. Documentation requirements

▼ M2

2.6.1. The manufacturer shall comply with the documentation requirements laid down in point 1.4 of Part A of Annex I to Implementing Regulation (EU) 2017/656 and Appendix 2 to that Annex.

2.6.2. The manufacturer shall ensure that all documents used for this purpose are marked with an identification number and date of issue. The manufacturer shall notify to the approval authority whenever the particulars recorded are changed. In this case, it shall issue, either a updated version of the documents concerned where the relevant pages are marked clearly showing the date of revision and the nature of the amendment, or alternatively, a new consolidated version accompanied by an index containing a detailed description and date of each amendment.

▼ B3. **Technical requirements relating to NO_x control measures**

3.1. This section 3 shall apply to electronically controlled engines of categories NRE, NRG, IWP, IWA, RLL and RLR, complying with 'stage V' emission limits set out in Annex II to Regulation (EU) 2016/1628 and using electronic control to determine both the quantity and timing of injecting fuel or using electronic control to activate, de-activate or modulate the emission control system used to reduce NO_x.

3.2. The manufacturer shall provide complete information on the functional operational characteristics of the NO_x control measures using the documents set out in Annex I to Implementing Regulation (EU) 2017/656.

3.3. The NO_x control strategy shall be operational under all environmental conditions regularly occurring in the territory of the Union, especially at low ambient temperatures.

3.4. The manufacturer shall demonstrate that the emission of ammonia during the applicable emission test cycle of the EU type-approval procedure, when a reagent is used, does not exceed a mean value of 25 ppm for engines of category RLL and 10 ppm for engines of all other applicable categories.

3.5. If reagent containers are installed on or connected to a non-road mobile machinery, means for taking a sample of the reagent inside the containers must be included. The sampling point must be easily accessible without requiring the use of any specialised tool or device.

3.6. In addition to the requirements set out in points 3.2 to 3.5, the following requirements shall apply:

▼B

- (a) For engines of category NRG the technical requirements set out in Appendix 1;
- (b) For engines of category NRE:
 - (i) the requirements set out in Appendix 2, when the engine is exclusively intended for use in the place of Stage V engines of categories IWP and IWA, in accordance with Article 4(1), point (1)(b) of Regulation (EU) 2016/1628; or
 - (ii) the requirements set out in Appendix 1 for engines not covered by subparagraph (i);
- (c) For engines of category IWP, IWA and RLR the technical requirements set out in Appendix 2;
- (d) For engines of category RLL the technical requirements set out in Appendix 3

4. Technical requirements relating to particulate pollutant control measures

- 4.1. This section shall apply to engines of sub-categories subject to a PN limit in accordance with the 'stage V' emission limits set out in Annex II to Regulation (EU) 2016/1628 fitted with a particulate after-treatment system. In cases where the NO_x control system and the particulate control system share the same physical components (e.g. same substrate (SCR on filter), same exhaust gas temperature sensor) the requirements of this section shall not apply to any component or malfunction where, after consideration of a reasoned assessment provided by the manufacturer, the approval authority concludes that a particulate control malfunction within the scope of this section would lead to a corresponding NO_x control malfunction within the scope of section 3.
- 4.2. The detailed technical requirements relating to particulate pollutant control measures are specified in Appendix 4.

▼ B*Appendix 1***Additional technical requirements on NO_x control measures for engines of categories NRE and NRG, including the method to demonstrate these strategies****1. Introduction**

This Appendix sets out the additional requirements to ensure the correct operation of NO_x control measures. It includes requirements for engines that rely on the use of a reagent in order to reduce emissions. The EU type-approval shall be made conditional upon the application of the relevant provisions on operator instruction, installation documents, operator warning system, inducement system and reagent freeze protection that are set out in this Appendix.

2. General requirements

The engine shall be equipped with a NO_x Control Diagnostic system (NCD) able to identify the NO_x control malfunctions (NCMs). Any engine covered by this section 2 shall be designed, constructed and installed so as to be capable of meeting these requirements throughout the normal life of the engine under normal conditions of use. In achieving this objective it is acceptable that engines which have been used in excess of the emission durability period as specified in Annex V to Regulation (EU) 2016/1628 show some deterioration in the performance and the sensitivity of the NO_x Control Diagnostic system (NCD), such that the thresholds specified in this Annex may be exceeded before the warning and/or inducement systems are activated.

2.1. Required information

2.1.1. If the emission control system requires a reagent, the type of reagent, information on concentration when the reagent is in solution, its operational temperature conditions a reference to international standards for composition and quality and other characteristics of that reagent shall be specified by the manufacturer in accordance with Part B of Annex I to Implementing Regulation (EU) 2017/656.

2.1.2. Detailed written information fully describing the functional operation characteristics of the operator warning system set out in section 4 and of the operator inducement system set out in section 5 shall be provided to the approval authority at the time of EU type-approval.

2.1.3. The manufacturer shall provide the OEM with documents with instructions on how to install the engine in the non-road mobile machinery in such manner that the engine, its emission control system and the non-road mobile machinery parts, operate in conformity with the requirements of this Appendix. This documentation shall include the detailed technical requirements of the engine (software, hardware, and communication) needed for the correct installation of the engine in the non-road mobile machinery.

2.2. Operating conditions**▼ M2**

2.2.1. Monitoring for reagent level in the storage tank shall be conducted under all conditions where measurement is technically feasible (for instance, under all conditions when a liquid reagent is not frozen).

▼ M2

- 2.2.2. Reagent freeze protection shall apply at ambient temperatures at or below 266 K (– 7 °C).
- 2.2.3. All elements of the NO_x control diagnostic system other than those listed in points 2.2.1 and 2.2.2 shall, at a minimum, be operational at the applicable control conditions set out in point 2.4 of this Annex for each engine category. The diagnostic system shall remain operational outside of this range where technically possible.

▼ B

- 2.3. Reagent freeze protection

▼ M2

- 2.3.1. It is permitted to use a heated or a non-heated reagent tank and dosing system. A heated system shall meet the requirements of points 2.3.2.2 to 2.3.2.2.4. A non-heated system shall meet the requirements of point 2.3.2.3.

▼ B

- 2.3.1.1. The use of a non-heated reagent tank and dosing system shall be indicated in the written instructions to the end-user of the non-road mobile machinery.

- 2.3.2. Reagent tank and dosing system

- 2.3.2.1. If the reagent has frozen, the reagent shall be available for use within a maximum of 70 minutes after the start of the engine at 266 K (– 7 °C) ambient temperature.

▼ M2

- 2.3.2.2. Design criteria for a heated system

A heated system shall be so designed that it meets the performance requirements set out in points 2.3.2 to 2.3.2.2.4 when tested using the procedure defined.

▼ B

- 2.3.2.2.1. The reagent tank and dosing system shall be soaked at 255 K (– 18 °C) for 72 hours or until the reagent becomes solid, whichever occurs first.

- 2.3.2.2.2. After the soak period set out in point 2.3.2.2.1, the non-road mobile machinery/engine shall be started and operated at 266 K (– 7 °C) ambient temperature or lower as follows:

(a) 10 to 20 minutes idling; followed by

(b) up to 50 minutes at no more than 40 % of rated load.

- 2.3.2.2.3. At the conclusion of the test procedure set out in point 2.3.2.2.2, the reagent dosing system shall be fully functional.

▼ M2

- 2.3.2.2.4. Evaluation of the design criteria may be performed in a cold chamber test cell using an entire non-road mobile machinery or parts representative of those to be installed on a non-road mobile machinery or based on field tests.

- 2.3.2.3. Activation of the operator warning and inducement system for a non-heated system.

▼ M2

- 2.3.2.3.1. The operator warning system described in points 4 to 4.9 shall be activated if no reagent dosing occurs at an ambient temperature ≤ 266 K (-7 °C).
- 2.3.2.3.2. The severe inducement system as referred to in point 5.4 shall be activated if no reagent dosing occurs within a maximum of 70 minutes after engine start at an ambient temperature ≤ 266 K (-7 °C).
-

▼ B

- 2.4. Diagnostic requirements
- 2.4.1 The NO_x Control Diagnostic system (NCD) shall be able to identify the NO_x control malfunctions (NCMs) by means of Diagnostic Trouble Codes (DTCs) stored in the computer memory and to communicate that information off-board upon request.
- 2.4.2 Requirements for recording Diagnostic Trouble Codes (DTCs)
- 2.4.2.1 The NCD system shall record a DTC for each distinct NO_x Control Malfunction (NCM).
- 2.4.2.2 The NCD system shall conclude within 60 minutes of engine operation whether a detectable malfunction is present. At this time, a 'confirmed and active' DTC shall be stored and the warning system be activated according to section 4.
- 2.4.2.3 In cases where more than 60 minutes running time is required for the monitors to accurately detect and confirm a NCM (e.g. monitors using statistical models or with respect to fluid consumption on the non-road mobile machinery), the approval authority may permit a longer period for monitoring provided the manufacturer justifies the need for the longer period (for example by technical rationale, experimental results, in house experience, etc.).
- 2.4.3. Requirements for erasing Diagnostic trouble codes (DTCs)
- (a) DTCs shall not be erased by the NCD system itself from the computer memory until the failure related to that DTC has been remedied.
- (b) The NCD system may erase all the DTCs upon request of a proprietary scan or maintenance tool that is provided by the engine manufacturer upon request, or using a pass code provided by the engine manufacturer.
- 2.4.4. An NCD system shall not be programmed or otherwise designed to partially or totally deactivate based on age of the non-road mobile machinery during the actual life of the engine, nor shall the system contain any algorithm or strategy designed to reduce the effectiveness of the NCD system over time.
- 2.4.5. Any reprogrammable computer codes or operating parameters of the NCD system shall be resistant to tampering.

▼ B

2.4.6. NCD engine family

The manufacturer is responsible for determining the composition of an NCD engine family. Grouping engines within an NCD engine family shall be based on good engineering judgment and be subject to approval by the approval authority.

Engines that do not belong to the same engine family may still belong to the same NCD engine family.

2.4.6.1. Parameters defining an NCD engine family

An NCD engine family is characterized by basic design parameters that shall be common to engines within the family.

In order that engines are considered to belong to the same NCD engine family, the following list of basic parameters shall be similar:

- (a) emission control systems;
- (b) methods of NCD monitoring;
- (c) criteria for NCD monitoring;
- (d) monitoring parameters (e.g. frequency).

These similarities shall be demonstrated by the manufacturer by means of relevant engineering demonstration or other appropriate procedures and subject to the approval of the approval authority.

The manufacturer may request approval by the approval authority of minor differences in the methods of monitoring/diagnosing the NCD system due to engine configuration variation, when these methods are considered similar by the manufacturer and they differ only in order to match specific characteristics of the components under consideration (for example size, exhaust gas flow, etc.); or their similarities are based on good engineering judgment.

3. **Maintenance requirements****▼ M2**

- 3.1. The OEM shall provide to all end-users of new non-road mobile machinery written instructions about the emission control system and its correct operation in accordance with Annex XV.

▼ B4. **Operator warning system**

- 4.1. The non-road mobile machinery shall include an operator warning system using visual alarms that informs the operator when a low reagent level, incorrect reagent quality, interruption of dosing or a malfunction specified in section 9 has been detected that will lead to activation of the operator inducement system if not rectified in a timely manner. The warning system shall remain active when the operator inducement system described in section 5 has been activated.
- 4.2. The warning shall not be the same as the warning used for the purposes of malfunction or other engine maintenance, though it may use the same warning system.

▼B

- 4.3. The operator warning system may consist of one or more lamps, or display short messages, which may include, for example, messages indicating clearly:
- (a) the remaining time before activation of the low-level and/or severe inducements,
 - (b) the amount of low-level and/or severe inducement, for example the amount of torque reduction,
 - (c) the conditions under which non-road mobile machinery disablement can be cleared.

Where messages are displayed, the system used for displaying these messages may be the same as the one used for other maintenance purposes.

- 4.4. At the choice of the manufacturer, the warning system may include an audible component to alert the operator. The cancelling of audible warnings by the operator is permitted.
- 4.5. The operator warning system shall be activated as specified in points 2.3.3.1, 6.2, 7.2, 8.4, and 9.3 respectively.
- 4.6. The operator warning system shall be deactivated when the conditions for its activation have ceased to exist. The operator warning system shall not be automatically deactivated without the reason for its activation having been remedied.
- 4.7. The warning system may be temporarily interrupted by other warning signals providing important safety related messages.
- 4.8. Details of the operator warning system activation and deactivation procedures are described in section 11.
- 4.9. As part of the application for EU type-approval under this Regulation, the manufacturer shall demonstrate the operation of the operator warning system, as specified in section 10.

5. **Operator inducement system**

- 5.1. The engine shall incorporate an operator inducement system based on one of the following principles:
- 5.1.1. a two-stage inducement system starting with a low-level inducement (performance restriction) followed by a severe inducement (effective disablement of non-road mobile machinery operation);
 - 5.1.2. a one-stage severe inducement system (effective disablement of non-road mobile machinery operation) activated under the conditions of a low-level inducement system as specified in points 6.3.1, 7.3.1, 8.4.1, and 9.4.1.

Where the manufacturer elects to shut down the engine to fulfil the requirement for one-stage severe inducement then the inducement for reagent level may, at the choice of the manufacturer, be activated under the conditions of point 6.3.2 instead of the conditions of point 6.3.1.

▼B

- 5.2. The engine may be fitted with a means to disable the operator inducement on condition that it complies with the requirements of point 5.2.1.
- 5.2.1 The engine may be fitted with a means to temporarily disable the operator inducement during an emergency declared by a national or regional government, their emergency services or their armed services.
- 5.2.1.1 All of the following conditions shall apply when a means to temporarily disable the operator inducement in an emergency is fitted to an engine:
- (a) The maximum operating period for which the inducement may be disabled by the operator shall be 120 hours;
 - (b) The method of activation shall be designed to prevent accidental operation by requiring a double voluntary action and shall be clearly marked, at a minimum, with the warning 'EMERGENCY USE ONLY';
 - (c) The disablement shall de-activate automatically after the 120 hours has expired, and there shall be a means for the operator to manually de-activate the disablement if the emergency has ended;
 - (d) After the 120 hours of operation has expired it shall no longer be possible to disable the inducement unless the means to disable has been re-armed by the input of a manufacturer's temporary security code, or re-configuration of the engine's ECU by a qualified service technician, or an equivalent security feature that is unique to each engine;
 - (e) The total number and duration of activations of the disablement must be stored in non-volatile electronic memory or counters in a manner to ensure that the information cannot be intentionally deleted. It shall be possible for national inspection authorities to read these records with a scan tool;

▼M2

- (ea) A description of the connection for, and method to read, the records referred to in point (e) shall be included in the information folder set out in Part A of Annex I to Implementing Regulation (EU) 2017/656;

▼B

- (f) The manufacturer shall maintain a record of each request to re-arm the means to temporarily disable the operator inducement and shall make those records available to Commission or national authorities upon request.
- 5.3. Low-level inducement system
- 5.3.1. The low-level inducement system shall be activated after any of the conditions specified in points 6.3.1, 7.3.1, 8.4.1, and 9.4.1 has occurred.
- 5.3.2. The low-level inducement system shall gradually reduce the maximum available engine torque across the engine speed range by at least 25 % between the peak torque speed and the governor breakpoint as shown in Figure 4.1. The rate of torque reduction shall be a minimum of 1 % per minute.

▼B

- 5.3.3. Other inducement measures that are demonstrated to the approval authority as having the same or greater level of severity may be used.

Figure 4.1

Low-level inducement torque reduction scheme

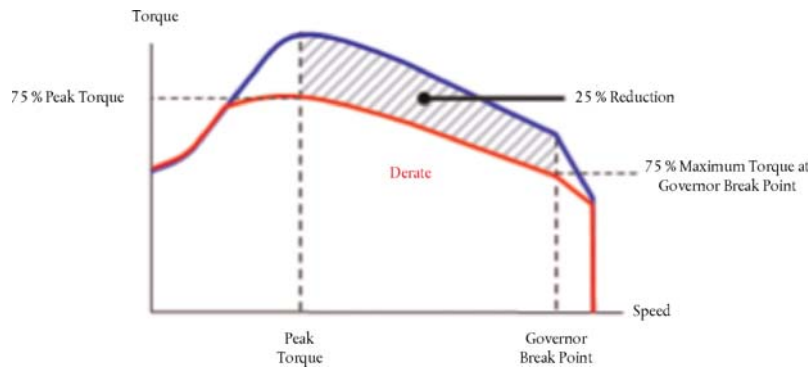

- 5.4. Severe inducement system
- 5.4.1. The severe inducement system shall be activated after any of the conditions specified in points 2.3.3.2, 6.3.2, 7.3.2, 8.4.2, and 9.4.2 has occurred.
- 5.4.2. The severe inducement system shall reduce the non-road mobile machinery's utility to a level that is sufficiently onerous as to cause the operator to remedy any problems related to sections 6 to 9. The following strategies are acceptable:
- 5.4.2.1. Engine torque between the peak torque speed and the governor breakpoint shall be gradually reduced from the low-level inducement torque in Figure 4.1 by a minimum of 1 % per minute to 50 % of maximum torque or lower and for variable-speed engines the engine speed shall be gradually reduced to 60 % of rated speed or lower within the same time period as the torque reduction, as shown in Figure 4.2.

Figure 4.2

Severe inducement torque reduction scheme

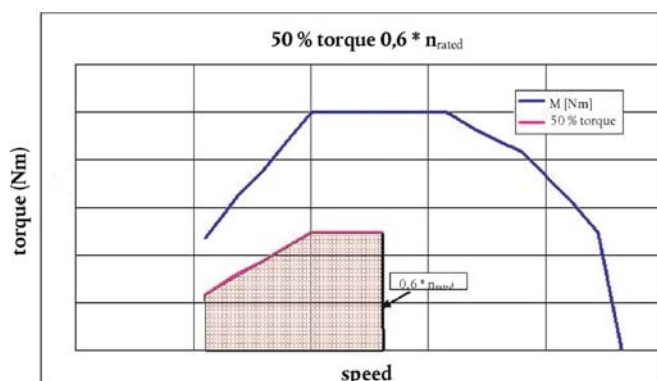

- 5.4.2.2. Other inducement measures that are demonstrated to the approval authority as having the same or greater level of severity may be used.

▼B

- 5.5. In order to account for safety concerns and to allow for self-healing diagnostics, use of an inducement override function for releasing full engine power is permitted provided it
- (a) is active for no longer than 30 minutes; and
 - (b) is limited to 3 activations during each period that the operator inducement system is active.
- 5.6. The operator inducement system shall be deactivated when the conditions for its activation have ceased to exist. The operator inducement system shall not be automatically deactivated without the reason for its activation having been remedied.
- 5.7. Details of the operator inducement system activation and deactivation procedures are described in section 11.
- 5.8. As part of the application for EU type-approval under this Regulation, the manufacturer shall demonstrate the operation of the operator inducement system, as specified in section 11.
- 6. Reagent availability**
- 6.1. Reagent level indicator
- The non-road mobile machinery shall include an indicator that clearly informs the operator of the level of reagent in the reagent storage tank. The minimum acceptable performance level for the reagent indicator is that it shall continuously indicate the reagent level whilst the operator warning system referred to in section 4 is activated. The reagent indicator may be in the form of an analogue or digital display, and may show the level as a proportion of the full tank capacity, the amount of remaining reagent, or the estimated operating hours remaining.
- 6.2. Activation of the operator warning system
- 6.2.1. The operator warning system specified in section 4 shall be activated when the level of reagent goes below 10 % of the capacity of the reagent tank or a higher percentage at the choice of the manufacturer.
- 6.2.2. The warning provided shall be sufficiently clear, in conjunction with the reagent indicator, for the operator to understand that the reagent level is low. When the warning system includes a message display system, the visual warning shall display a message indicating a low level of reagent. (for example 'urea level low', 'AdBlue level low', or 'reagent low').
- 6.2.3. The operator warning system does not initially need to be continuously activated (for example a message does not need to be continuously displayed), however activation shall escalate in intensity so that it becomes continuous as the level of the reagent approaches empty and the point where the operator inducement system will come into effect is approached (for example frequency at which a lamp flashes). It shall culminate in an operator notification at a level that is at the choice of the manufacturer, but sufficiently more noticeable at the point where the operator inducement system in point 6.3 comes into effect than when it was first activated.

▼ B

- 6.2.4. The continuous warning shall not be easily disabled or ignored. When the warning system includes a message display system, an explicit message shall be displayed (for example ‘fill up urea’, ‘fill up AdBlue’, or ‘fill up reagent’). The continuous warning may be temporarily interrupted by other warning signals providing important safety related messages.
- 6.2.5. It shall not be possible to turn off the operating warning system until the reagent has been replenished to a level not requiring its activation.
- 6.3 Activation of the operator inducement system
- 6.3.1 The low-level inducement system described in point 5.3 shall be activated if the reagent tank level goes below 2,5 % of its nominally full capacity or a higher percentage at the choice of the manufacturer.
- 6.3.2. The severe inducement system described in point 5.4 shall be activated if the reagent tank is empty, that is, when the dosing system is unable to draw further reagent from the tank, or at any level below 2,5 % of its nominally full capacity at the discretion of the manufacturer.
- 6.3.3. Except to the extent permitted by point 5.5, it shall not be possible to turn off the low-level or severe inducement system until the reagent has been replenished to a level not requiring their respective activation.
7. **Reagent quality monitoring**
- 7.1. The engine or non-road mobile machinery shall include a means of determining the presence of an incorrect reagent on board a non-road mobile machinery.
- 7.1.1. The manufacturer shall specify a minimum acceptable reagent concentration CD_{min} , which results in tailpipe NO_x emissions not exceeding the lower of either the applicable NO_x limit multiplied by 2,25 or the applicable NO_x limit plus 1,5 g/kWh. For engine sub-categories with a combined HC and NO_x limit, the applicable NO_x limit value for the purpose of this point shall be the combined limit value for HC and NO_x reduced by 0,19 g/kWh.

▼ M2

- 7.1.1.1. The value of CD_{min} specified by the manufacturer shall be used during the demonstration set out in section 13 and recorded in Part C of the information document specified in Annex I to Implementing Regulation (EU) 2017/656.

▼ B

- 7.1.2. Any reagent concentration lower than CD_{min} shall be detected and be regarded, for the purpose of point 7.1, as being incorrect reagent.
- 7.1.3. A specific counter (‘the reagent quality counter’) shall be attributed to the reagent quality. The reagent quality counter shall count the number of engine operating hours with an incorrect reagent.

▼B

- 7.1.3.1. Optionally, the manufacturer may group the reagent quality failure together with one or more of the failures listed in sections 8 and 9 into a single counter.
- 7.1.4. Details of the reagent quality counter activation and deactivation criteria and mechanisms are described in section 11.
- 7.2. Activation of the operator warning system
- When the monitoring system confirms that the reagent quality is incorrect, the operator warning system described in section 4 shall be activated. When the warning system includes a message display system, it shall display a message indicating the reason of the warning (for example 'incorrect urea detected', 'incorrect AdBlue detected', or 'incorrect reagent detected').
- 7.3 Activation of the operator inducement system
- 7.3.1. The low-level inducement system described in point 5.3 shall be activated if the reagent quality is not rectified within a maximum of 10 engine operating hours after the activation of the operator warning system as described in point 7.2.
- 7.3.2. The severe inducement system described in point 5.4 shall be activated if the reagent quality is not rectified within a maximum of 20 engine operating hours after the activation of the operator warning system as described in point 7.2.
- 7.3.3. The number of hours prior to activation of the inducement systems shall be reduced in case of a repetitive occurrence of the malfunction according to the mechanism described in section 11.
8. **Reagent dosing activity**
- 8.1 The engine shall include a means of determining interruption of dosing.
- 8.2. Reagent dosing activity counter
- 8.2.1. A specific counter shall be attributed to the dosing activity (the 'dosing activity counter'). The counter shall count the number of engine operating hours which occur with an interruption of the reagent dosing activity. This is not required where such interruption is demanded by the engine ECU because the non-road mobile machinery operating conditions are such that the non-road mobile machinery's emission performance does not require reagent dosing.
- 8.2.1.1. Optionally, the manufacturer may group the reagent dosing failure together with one or more of the failures listed in sections 7 and 9 into a single counter.
- 8.2.2. Details of the reagent dosing activity counter activation and deactivation criteria and mechanisms are described in section 11.
- 8.3. Activation of the operator warning system
- The operator warning system described in section 4 shall be activated in the case of interruption of dosing which sets the dosing activity counter in accordance with point 8.2.1. When the warning system includes a message display system, it shall display a message indicating the reason of the warning (e.g. 'urea dosing malfunction', 'AdBlue dosing malfunction', or 'reagent dosing malfunction').

▼ B

- 8.4. Activation of the operator inducement system
 - 8.4.1. The low-level inducement system described in point 5.3 shall be activated if an interruption in reagent dosing is not rectified within a maximum of 10 engine operating hours after the activation of the operator warning system in accordance with point 8.3.
 - 8.4.2. The severe inducement system described in point 5.4 shall be activated if an interruption in reagent dosing is not rectified within a maximum of 20 engine operating hours after the activation of the operator warning system in accordance with point 8.3.
 - 8.4.3. The number of hours prior to activation of the inducement systems shall be reduced in case of a repetitive occurrence of the malfunction according to the mechanism described in section 11.

▼ M2

- 9. **Other failures that may be attributed to tampering**
 - 9.1. In addition to the level of reagent in the reagent tank, the reagent quality, and the interruption of dosing, the following failures shall be monitored because they may be attributed to tampering:
 - (a) failures of the NO_x Control Diagnostic (NCD) system as described in point 9.2.1;
 - (b) failures of the exhaust gas recirculation (EGR) valve as described in point 9.2.2.
 - 9.2. Monitoring requirements and counters
 - 9.2.1. NCD system
 - 9.2.1.1. The NO_x Control Diagnostic (NCD) system shall be monitored for electrical failures and for removal or deactivation of any sensor that prevents it from diagnosing any other failures set out in sections 6 to 8 (component monitoring).

A non-exhaustive list of sensors that affect the diagnostic capability are those directly measuring NO_x concentration, urea quality sensors, ambient sensors and sensors used for monitoring reagent dosing activity, reagent level, or reagent consumption.
 - 9.2.1.2. A counter shall be attributed to each of the monitoring failures. The NCD system counters shall count the number of engine operating hours when the DTC associated to a malfunction of the NCD system is confirmed to be active. Different NCD system failures may be grouped into a single counter.
 - 9.2.1.2.1. The manufacturer may group the NCD system failure together with one or more of the systems listed in sections 7, 8 and point 9.2.2 into a single counter.
 - 9.2.1.3. Details of the NCD system counter(s) activation and deactivation criteria and mechanisms are described in section 11.
 - 9.2.2. Impeded EGR valve
 - 9.2.2.1. The exhaust gas recirculation (EGR) system shall be monitored for an impeded EGR valve.

▼ M2

- 9.2.2.2. A counter shall be attributed to an impeded EGR valve. The EGR valve counter shall count the number of engine operating hours when the DTC associated to an impeded EGR valve is confirmed to be active.
- 9.2.2.2.1. The manufacturer may group the impeded EGR valve failure together with one or more of the systems listed in sections 7, 8 and point 9.2.1 into a single counter.
- 9.2.2.3. Details of the EGR valve counter activation and deactivation criteria and mechanisms are described in section 11.

▼ B

- 9.3. Activation of the operator warning system
- The operator warning system set out in section 4 shall be activated in case any of the failures specified in point 9.1 occur, and shall indicate that an urgent repair is required. When the warning system includes a message display system, it shall display a message indicating either the reason of the warning (for example 'reagent dosing valve disconnected', or 'critical emission failure').
- 9.4. Activation of the operator inducement system
- 9.4.1. The low-level inducement system described in point 5.3 shall be activated if a failure specified in point 9.1 is not rectified within a maximum of 36 engine operating hours after the activation of the operator warning system set out in point 9.3.
- 9.4.2. The severe inducement system described in point 5.4 shall be activated if a failure specified in point 9.1 is not rectified within a maximum of 100 engine operating hours after the activation of the operator warning system set out in point 9.3.
- 9.4.3. The number of hours prior to activation of the inducement systems shall be reduced in case of a repetitive occurrence of the malfunction according to the mechanism described in section 11.

▼ M2

- 9.5. As an alternative to the monitoring requirements set out in point 9.2, the manufacturer may monitor for failures using a NO_x sensor located in the exhaust system. In this case,
- (a) the NO_x value at which the NCM shall be detected shall not exceed the lower of either the applicable NO_x limit multiplied by 2,25 or the applicable NO_x limit plus 1,5 g/kWh. For engine sub-categories with a combined HC and NO_x limit, the applicable NO_x limit value for the purpose of this point shall be the combined limit value for HC and NO_x reduced by 0,19 g/kWh.
- (b) a single warning may be used, including, where messages are used, the statement 'high NO_x – root cause unknown',
- (c) in point 9.4.1 the maximum number of engine operating hours between the activation of the operator warning system and the activation of the low-level inducement system shall be reduced to 10,

▼ M2

- (d) in point 9.4.2 the maximum number of engine operating hours between the activation of the operator warning system and the activation of the severe inducement system shall be reduced to 20.

▼ B10. **Demonstration requirements**

10.1. General

The compliance to the requirements of this Appendix shall be demonstrated during EU type-approval by performing, as illustrated in Table 4.1 and specified in this section 10:

- (a) a demonstration of the warning system activation;
- (b) a demonstration of the low level inducement system activation, if applicable;
- (c) a demonstration of the severe inducement system activation

10.2. Engine families and NCD engine families

The compliance of an engine family or an NCD engine family with the requirements of this section 10 may be demonstrated by testing one of the members of the considered family, provided the manufacturer demonstrates to the approval authority that the monitoring systems necessary for complying with the requirements of this Appendix are similar within the family.

▼ M2

- 10.2.1. The demonstration that the monitoring systems for other members of the NCD engine family are similar may be performed by presenting to the approval authorities such elements as algorithms, functional analyses, etc.

▼ B

- 10.2.2. The test engine is selected by the manufacturer in agreement with the approval authority. It may or may not be the parent engine of the considered family.

▼ M2

- 10.2.3. In the case where engines of an engine family belong to an NCD engine family that has already been EU type-approved, as referred to in point 10.2.1 (Figure 4.3), the compliance of that engine family is deemed to be demonstrated without further testing, provided the manufacturer demonstrates to the authority that the monitoring systems necessary for complying with the requirements of this Appendix are similar within the considered engine and NCD engine families.

Table 4.1

Illustration of the content of the demonstration process in accordance with the provisions in points 10.3 and 10.4.

Mechanism	demonstration elements
Warning system activation specified in point 10.3	<ul style="list-style-type: none"> — 2 activation tests (incl. lack of reagent) — Supplementary demonstration elements, as appropriate
Low-level inducement activation specified in point 10.4.	<ul style="list-style-type: none"> — 2 activation tests (incl. lack of reagent) — Supplementary demonstration elements, as appropriate — 1 torque reduction test

▼ M2

Mechanism	demonstration elements
Severe inducement activation specified in point 10.4	<ul style="list-style-type: none"> — 2 activation tests (incl. lack of reagent) — Supplementary demonstration elements, as appropriate

▼ B

Figure 4.3

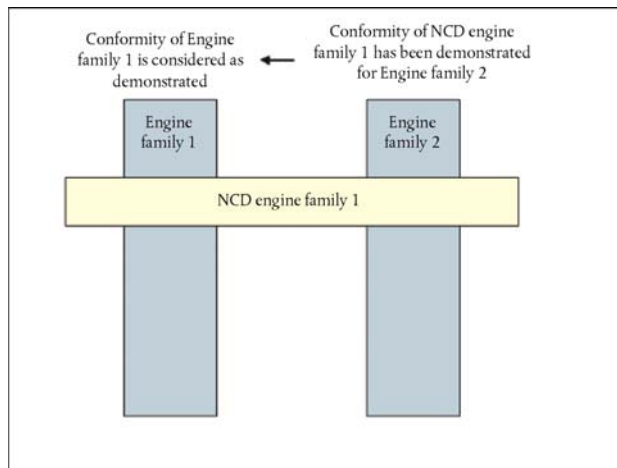
Previously demonstrated conformity of an NCD engine family

10.3. Demonstration of the warning system activation

▼ M2

- 10.3.1. The compliance of the warning system activation shall be demonstrated by performing two tests: lack of reagent, and one failure category identified in sections 7, 8 or 9.
- 10.3.2. Selection of the failure to be tested among those referred to in sections 7, 8 or 9.
- 10.3.2.1. The approval authority shall select one failure category. In the case that a failure is selected from points 7 or 9, the additional requirements set out in points 10.3.2.2 or 10.3.2.3 shall apply, respectively.
- 10.3.2.2. For the purpose of demonstrating the activation of the warning system in case of a wrong reagent quality, a reagent shall be selected with a dilution of the active ingredient at least as dilute as that communicated by the manufacturer in accordance with the requirements set out in points 7 to 7.3.3.
- 10.3.2.3. For the purpose of demonstrating the activation of the warning system in case of failures that may be attributed to tampering, and are defined in section 9 the selection shall be performed in accordance with the following requirements:
- 10.3.2.3.1. The manufacturer shall provide the approval authority with a list of such potential failures.
- 10.3.2.3.2. The failure to be considered in the test shall be selected by the approval authority from the list referred to in point 10.3.2.3.1.

▼ M2

- 10.3.3. Demonstration
- 10.3.3.1. For the purpose of this demonstration, a separate test shall be performed for the lack of reagent and the failure selected in accordance with points 10.3.2 to 10.3.2.3.2.

▼ B

- 10.3.3.2. During a test, no failure shall be present other than the one addressed by the test.
- 10.3.3.3. Prior to starting a test, all DTC shall have been erased.
- 10.3.3.4. At the request of the manufacturer, and with the agreement of the approval authority, the failures subject to testing may be simulated.
- 10.3.3.5. Detection of failures other than lack of reagent.
- For failures other than lack of reagent, once the failure installed or simulated, the detection of that failure shall be performed as follows:
- 10.3.3.5.1. The NCD system shall respond to the introduction of a failure selected as appropriate by the approval authority in accordance to the provisions of this Appendix. This is considered to be demonstrated if activation occurs within two consecutive NCD test-cycles according to point 10.3.3.7.

When it has been specified in the monitoring description and agreed by the approval authority that a specific monitor needs more than two NCD test-cycles to complete its monitoring, the number of NCD test-cycles may be increased to 3 NCD test-cycles.

Each individual NCD test-cycle in the demonstration test may be separated by an engine shut-off. The time until the next start-up shall take into consideration any monitoring that may occur after engine shut-off and any necessary condition that must exist for monitoring to occur at the next start up.

▼ M2

- 10.3.3.5.2. The demonstration of the warning system activation is deemed to be accomplished if, at the end of each demonstration test performed in accordance with point 10.3.3, the warning system has been properly activated and the DTC for the selected failure has got the 'confirmed and active' status.

▼ B

- 10.3.3.6. Detection in case of lack of reagent availability
- For the purpose of demonstrating the activation of the warning system in case of lack of reagent availability, the engine shall be operated over one or more NCD test cycles at the discretion of the manufacturer.
- 10.3.3.6.1. The demonstration shall start with a level of reagent in the tank to be agreed between the manufacturer and the approval authority but representing not less than 10 % of the nominal capacity of the tank.
- 10.3.3.6.2. The warning system is deemed to have performed in the correct manner if the following conditions are met simultaneously:
- (a) the warning system has been activated with a reagent availability greater or equal to 10 % of the capacity of the reagent tank; and
 - (b) the 'continuous' warning system has been activated with a reagent availability greater or equal to the value declared by the manufacturer in accordance with the provisions of section 6.

▼ B

- 10.3.3.7. NCD test cycle
- 10.3.3.7.1 The NCD test cycle considered in this section 10 for demonstrating the correct performance of the NCD system is the hot-start NRTC cycle for engines of sub-category NRE-v-3, NRE-v-4, NRE-v-5 NRE-v-6 and the applicable NRSC for all other categories.
- 10.3.3.7.2 On request of the manufacturer and with approval of the approval authority, an alternative NCD test-cycle can be used (e.g. other than the NTRC or the NRSC) for a specific monitor. The request shall contain elements (technical considerations, simulation, test results, etc.) demonstrating:
- (a) the requested test-cycle results in a monitor that will run in real world operations; and
 - (b) the applicable NCD test-cycle specified in point 10.3.3.7.1 is shown to be less appropriate for the considered monitoring.
- 10.3.4. The demonstration of the warning system activation is deemed to be accomplished if, at the end of each demonstration test performed according to point 10.3.3, the warning system has been properly activated.
- 10.4. Demonstration of the inducement system
- 10.4.1. The demonstration of the inducement system shall be done by tests performed on an engine test bench.
- 10.4.1.1. Any components or sub-systems not physically mounted on the engine, such as, but not limited to, ambient temperature sensors, level sensors, and operator warning and information systems, that are required in order to perform the demonstrations shall be connected to the engine for that purpose, or shall be simulated, to the satisfaction of the approval authority.
- 10.4.1.2. If the manufacturer chooses, and subject to the agreement of the approval authority, the demonstration tests may be performed on a complete non-road mobile machinery or machinery either by mounting the non-road mobile machinery on a suitable test bed or, notwithstanding point 10.4.1, by running it on a test track under controlled conditions.

▼ M2

- 10.4.2. The test sequence shall demonstrate the activation of the inducement system in case of the failure selected by the approval authority from the list as referred to in point 10.3.2.1 for the test of the warning system.
- 10.4.3. For the purpose of this demonstration,
- (a) the manufacturer shall, in agreement with the approval authority, be permitted to accelerate the test by simulating the achievement of a certain number of operating hours,
 - (b) the achievement of the torque reduction required for low-level inducement may be demonstrated at the same time as the general engine performance approval process performed in accordance with this Regulation. A separate torque measurement during the inducement system demonstration is not required in this case,
 - (c) the low-level inducement, if applicable, shall be demonstrated in accordance with the requirements of point 10.4.5,

▼ M2

(d) the severe inducement shall be demonstrated in accordance with the requirements of point 10.4.6.

▼ B

10.4.4. The manufacturer shall, in addition, demonstrate the operation of the inducement system under those failure conditions defined in sections 7, 8 or 9 which have not been chosen for use in demonstration tests described in points 10.4.1 to 10.4.3.

These additional demonstrations may be performed by presentation to the approval authority of a technical case using evidence such as algorithms, functional analyses, and the result of previous tests.

10.4.4.1. These additional demonstrations shall in particular demonstrate to the satisfaction of the approval authority the inclusion of the correct torque reduction mechanism in the engine ECU.

10.4.5. Demonstration test of the low-level inducement system

10.4.5.1. This demonstration starts when the warning system or when appropriate 'continuous' warning system has been activated as a result of the detection of a failure selected by the approval authority.

10.4.5.2. When the system is being checked for its reaction to the case of lack of reagent in the tank, the engine shall be run until the reagent availability has reached a value of 2,5 % of the tank nominal full capacity of the tank or the value declared by the manufacturer in accordance with point 6.3.1 at which the low-level inducement system is intended to operate.

10.4.5.2.1. The manufacturer may, with the agreement of the approval authority, simulate continuous running by extracting reagent from the tank, either whilst the engine is running or is stopped.

10.4.5.3. When the system is checked for its reaction in the case of a failure other than a lack of reagent in the tank, the engine shall be run for the relevant number of operating hours indicated in Table 4.3 or, at the choice of the manufacturer, until the relevant counter has reached the value at which the low-level inducement system is activated.

10.4.5.4. The demonstration of the low level inducement system shall be deemed to be accomplished if, at the end of each demonstration test performed according to points 10.4.5.2 and 10.4.5.3, the manufacturer has demonstrated to the approval authority that the engine ECU has activated the torque reduction mechanism.

10.4.6. Demonstration test of the severe inducement system

10.4.6.1. This demonstration shall start from a condition where the low-level inducement system has been previously activated and may be performed as a continuation of the tests undertaken to demonstrate the low-level inducement system.

10.4.6.2. When the system is checked for its reaction in the case of lack of reagent in the tank, the engine shall be run until the reagent tank is empty, or has reached the level below 2,5 % of nominal full capacity of the tank at which the manufacturer has declared to activate the severe inducement system.

10.4.6.2.1. The manufacturer may, with the agreement of the approval authority, simulate continuous running by extracting reagent from the tank, either whilst the engine is running or is stopped.

▼ B

- 10.4.6.3. When the system is checked for its reaction in the case of a failure that is not a lack of reagent in the tank, the engine shall then be run for the relevant number of operating hours indicated in Table 4.4 or, at the choice of the manufacturer, until the relevant counter has reached the value at which the severe inducement system is activated.
- 10.4.6.4. The demonstration of the severe inducement system shall be deemed to be accomplished if, at the end of each demonstration test performed according to points 10.4.6.2 and 10.4.6.3, the manufacturer has demonstrated to the approval authority that the severe inducement mechanism considered in this Appendix has been activated.
- 10.4.7. Alternatively, if the manufacturer chooses, and subject to the agreement of the approval authority, the demonstration of the inducement mechanisms may be performed on a complete non-road mobile machinery in accordance with the requirements of points 5.4 and 10.4.1.2, either by mounting the non-road mobile machinery on a suitable test bed or by running it on a test track under controlled conditions.
- 10.4.7.1. The non-road mobile machinery shall be operated until the counter associated with the selected failure has reached the relevant number of operating hours indicated in Table 4.4 or, as appropriate, until either the reagent tank is empty or, has reached the level below 2,5 % of nominal full capacity of the tank at which the manufacturer has chosen to activate the severe inducement system.

▼ M2

- 10.5. Documentation of the demonstration
- 10.5.1. A demonstration report shall document the demonstration of the NCD system. The report shall:
- (a) identify the failures examined;
 - (b) describe the demonstration performed including the applicable test cycle;
 - (c) confirm that the applicable warnings and inducements were activated as required by this regulation; and
 - (d) be included in the information folder as set out in Part A of Annex I of Implementing Regulation (EU) 2017/656.

▼ B

- 11. Description of the operator warning and inducement activation and deactivation mechanisms**
- 11.1 To complement the requirements specified in this Appendix concerning the warning and inducement activation and deactivation mechanisms, this section 11 specifies the technical requirements for an implementation of those activation and deactivation mechanisms.
- 11.2. Activation and deactivation mechanisms of the warning system
- 11.2.1. The operator warning system shall be activated when the diagnostic trouble code (DTC) associated with a NCM justifying its activation has the status defined in Table 4.2.

▼B

Table 4.2

Activation of the operator warning system

Failure type	DTC status for activation of the warning system
Poor reagent quality	confirmed and active
Interruption of dosing	confirmed and active
Impeded EGR valve	confirmed and active
Malfunction of the monitoring system	confirmed and active
NO _x threshold, if applicable	confirmed and active

11.2.2. The operator warning system shall be deactivated when the diagnosis system concludes that the malfunction relevant to that warning is no longer present or when the information including DTCs relative to the failures justifying its activation is erased by a scan tool.

11.2.2.1 Requirements for erasing 'NO_x control information'

11.2.2.1.1 Erasing/resetting 'NO_x control information' by a scan-tool

On request of the scan tool, the following data shall be erased or reset to the value specified in this Appendix from the computer memory (see Table 4.3).

Table 4.3

Erasing / resetting 'NO_x control information' by a scan-tool

NO _x control information	Erasable	Resettable
All DTCs	X	
The value of the counter with the highest number of engine operating hours		X
The number of engine operating hours from the NCD counter(s)		X

11.2.2.1.2. NO_x control information shall not be erased by disconnection of the non-road mobile machinery's battery(s).

11.2.2.1.3. The erasing of 'NO_x control information' shall only be possible under 'engine-off' conditions.

▼ B

- 11.2.2.1.4. When ‘NO_x control information’ including DTCs are erased, any counter associated with these failures and which is specified in this Appendix shall not be erased, but reset to the value specified in the appropriate section of this Appendix.
- 11.3. Activation and deactivation mechanism of the operator inducement system
- 11.3.1. The operator inducement system shall be activated when the warning system is active and the counter relevant to the type of NCM justifying their activation have reached the value specified in Table 4.4.
- 11.3.2. The operator inducement system shall be deactivated when the system no longer detects a malfunction justifying its activation, or if the information including the DTCs relative to the NCMs justifying its activation has been erased by a scan tool or maintenance tool.
- 11.3.3. The operator warning and inducement systems shall be immediately activated or deactivated as appropriate according to the provisions of section 6 after assessment of the reagent quantity in the reagent tank. In that case, the activation or deactivation mechanisms shall not depend upon the status of any associated DTC.
- 11.4. Counter mechanism
- 11.4.1. General

▼ M2

- 11.4.1.1. To comply with the requirements of this Appendix, the system shall contain counters to record the number of hours during which the engine has been operated while the system has detected any of the following NCM:
- (a) an incorrect reagent quality;
 - (b) an interruption of reagent dosing activity;
 - (c) an impeded EGR valve;
 - (d) a failure of the NCD system.
- 11.4.1.1.1. The manufacturer may use one or more counters for grouping the NCMs indicated in point 11.4.1.1.

▼ B

- 11.4.1.2. Each of the counters shall count up to the maximum value provided in a 2 byte counter with 1 hour resolution and hold that value unless the conditions allowing the counter to be reset to zero are met.
- 11.4.1.3. A manufacturer may use a single or multiple NCD system counters. A single counter may accumulate the number of hours of 2 or more different malfunctions relevant to that type of counter, none of them having reached the time the single counter indicates.
- 11.4.1.3.1. When the manufacturer decides to use multiple NCD system counters, the system shall be capable of assigning a specific monitoring system counter to each malfunction relevant according to this Appendix to that type of counters.

▼B

11.4.2. Principle of counters mechanism

11.4.2.1. Each of the counters shall operate as follows:

11.4.2.1.1. If starting from zero, the counter shall begin counting as soon as a malfunction relevant to that counter is detected and the corresponding diagnostic trouble code (DTC) has the status defined in Table 4.2.

11.4.2.1.2. In case of repeated failures, one of the following provisions shall apply at the choice of the manufacturer.

(a) If a single monitoring event occurs and the malfunction that originally activated the counter is no longer detected or if the failure has been erased by a scan tool or a maintenance tool, the counter shall halt and hold its current value. If the counter stops counting when the severe inducement system is active, the counter shall be kept frozen at the value defined in Table 4.4 or a value of greater than or equal to the counter value for severe inducement minus 30 minutes.

(b) The counter shall be kept frozen at the value defined in Table 4.4 or a value of greater than or equal to the counter value for severe inducement minus 30 minutes.

11.4.2.1.3. In the case of a single monitoring system counter, that counter shall continue counting if a NCM relevant to that counter has been detected and its corresponding Diagnostic trouble code (DTC) has the status 'confirmed and active'. It shall halt and hold one of the values specified in point 11.4.2.1.2, if no NCM that would justify the counter activation is detected or if all the failures relevant to that counter have been erased by a scan tool or a maintenance tool.

Table 4.4

Counters and inducement

	DTC status for first activation of the counter	Counter value for low-level inducement	Counter value for severe inducement	Frozen value held by the counter
Reagent quality counter	confirmed and active	≤ 10 hours	≤ 20 hours	≥ 90 % of counter value for severe inducement
Dosing counter	confirmed and active	≤ 10 hours	≤ 20 hours	≥ 90 % of counter value for severe inducement
EGR valve counter	confirmed and active	≤ 36 hours	≤ 100 hours	≥ 95 % of counter value for severe inducement
Monitoring system counter	confirmed and active	≤ 36 hours	≤ 100 hours	≥ 95 % of counter value for severe inducement
NO _x threshold, if applicable	confirmed and active	≤ 10 hours	≤ 20 hours	≥ 90 % of counter value for severe inducement

11.4.2.1.4. Once frozen, the counter shall be reset to zero when the monitors relevant to that counter have run at least once to completion of their monitoring cycle without having detected a malfunction and no

▼B

malfunction relevant to that counter has been detected during 40 engine operating hours since the counter was last held (see Figure 4.4).

- 11.4.2.1.5. The counter shall continue counting from the point at which it had been held if a malfunction relevant to that counter is detected during a period when the counter is frozen (see Figure 4.4).

12. Illustration of the activation and deactivation and counter mechanisms

- 12.1. This section 12 illustrates the activation and deactivation and counter mechanisms for some typical cases. The Figures and descriptions given in points 12.2, 12.3 and 12.4 are provided solely for the purposes of illustration in this Appendix and should not be referenced as examples of either the requirements of this Regulation or as definitive statements of the processes involved. The counter hours in Figures 4.6 and 4.7 refer to the maximum severe inducement values in Table 4.4. For simplification purposes, for example, the fact that the warning system will also be active when the inducement system is active has not been mentioned in the illustrations given.

Figure 4.4

Reactivation and resetting to zero of a counter after a period when its value has been frozen

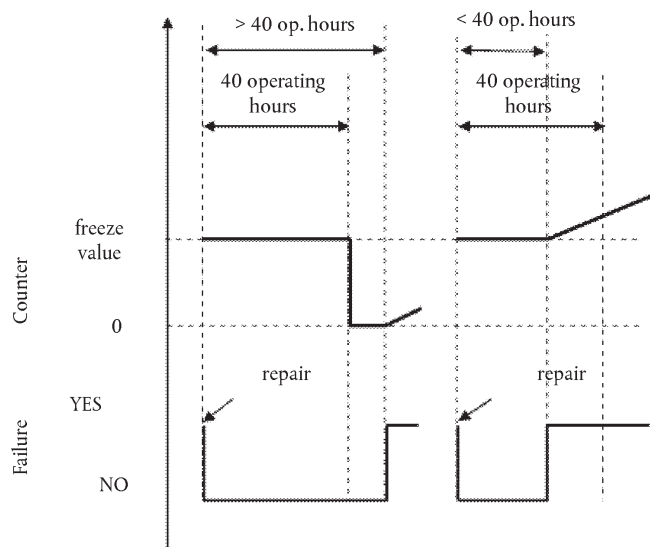

- 12.2. Figure 4.5 illustrates the operation of the activation and deactivation mechanisms when monitoring the reagent availability for four cases:

- (a) use case 1: the operator continues operating the non-road mobile machinery in spite of the warning until non-road mobile machinery operation is disabled;

▼B

- (b) refilling case 1 ('adequate' refilling): the operator refills the reagent tank so that a level above the 10 % threshold is reached. Warning and inducement are de-activated;
- (c) refilling cases 2 and 3 ('inadequate' refilling): The warning system is activated. The level of warning depends on the amount of available reagent;
- (d) refilling case 4 ('very inadequate' refilling): The low level inducement is activated immediately.

Figure 4.5

Reagent availability

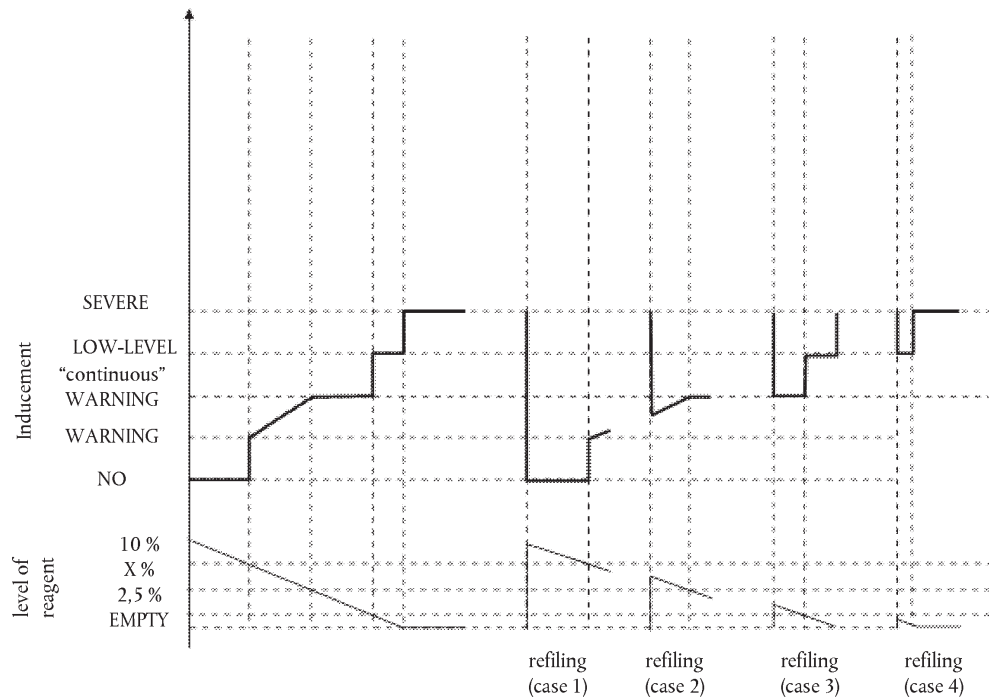

12.3. Figure 4.6 illustrates three cases of wrong reagent quality:

- (a) use case 1: the operator continues operating the non-road mobile machinery in spite of the warning until non-road mobile machinery operation is disabled.
- (b) repair case 1 ('bad' or 'dishonest' repair): after disablement of the non-road mobile machinery, the operator changes the quality of the reagent, but soon after, changes it again for a poor quality one. The inducement system is immediately reactivated and non-road mobile machinery operation is disabled after 2 engine operating hours.

▼B

- (c) repair case 2 ('good' repair): after disablement of the non-road mobile machinery, the operator rectifies the quality of the reagent. However some time afterwards, he refills again with a poor quality reagent. The warning, inducement and counting processes restart from zero.

Figure 4.6

Filling with poor reagent quality

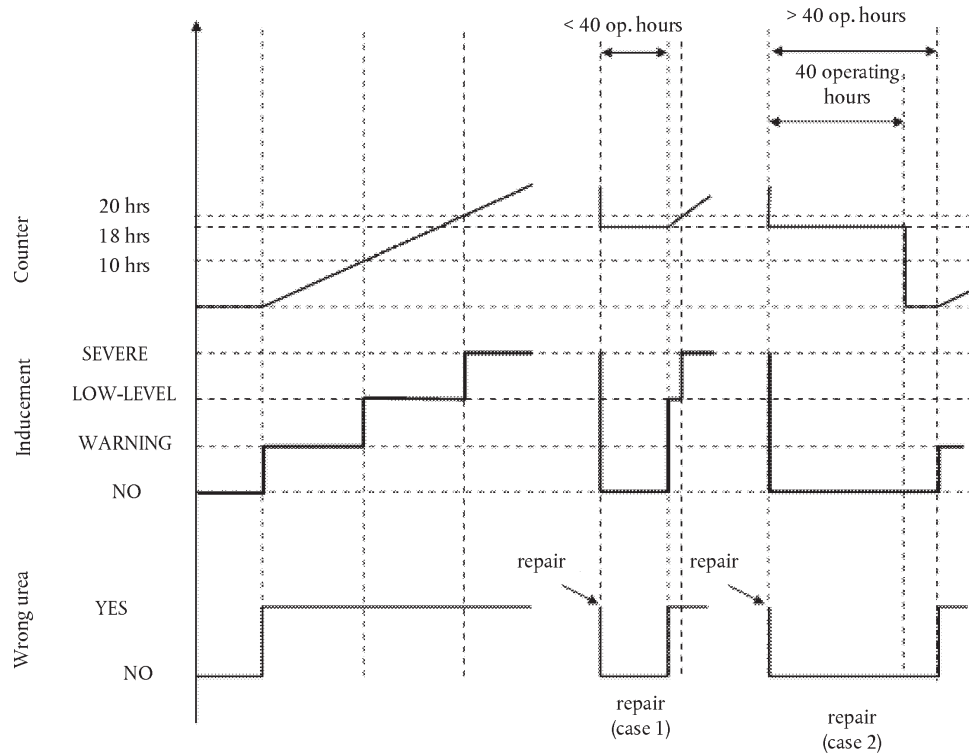

12.4. Figure 4.7 illustrates three cases of failure of the urea dosing system. This Figure also illustrates the process that applies in the case of the monitoring failures described in section 9:

- (a) use case 1: the operator continues operating the non-road mobile machinery in spite of the warning until non-road mobile machinery operation is disabled.
- (b) repair case 1 ('good' repair): after disablement of the non-road mobile machinery, the operator repairs the dosing system. However some time afterwards, the dosing system fails again. The warning, inducement and counting processes restart from zero.
- (c) repair case 2 ('bad' repair): during the low-level inducement time (torque reduction), the operator repairs the dosing system. Soon after, however, the dosing system fails again. The low-level inducement system is immediately reactivated and the counter restarts from the value it had at the time of repair.



Figure 4.7

Failure of the reagent dosing system

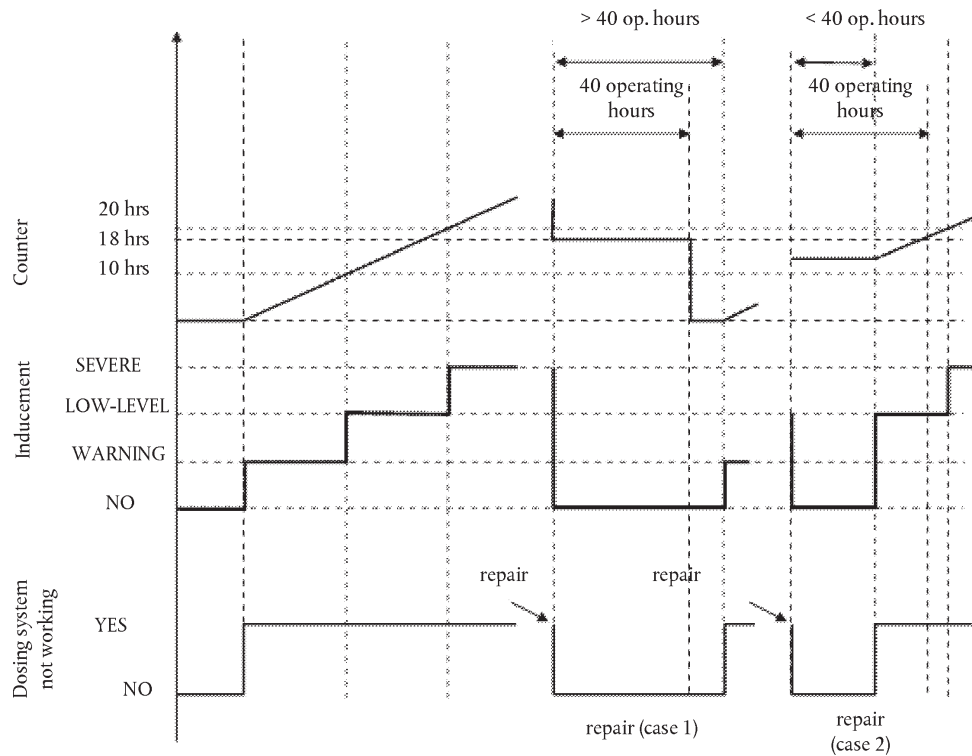

13. **Demonstration of the minimum acceptable reagent concentration CD_{min}**

- 13.1. The manufacturer shall demonstrate the correct value of CD_{min} during EU type-approval by performing the hot-start NRTC cycle for engines of sub-category NRE-v-3, NRE-v-4, NRE-v-5 NRE-v-6 and the applicable NRSC for all other categories using a reagent with the concentration CD_{min} .
- 13.2. The test shall follow the appropriate NCD cycle(s) or manufacturer defined pre-conditioning cycle, permitting a closed loop NO_x control system to perform adaptation to the quality of the reagent with the concentration CD_{min} .

▼ M2

- 13.3. The pollutant emissions resulting from this test shall not exceed the NO_x threshold specified in point 7.1.1.
- 13.4. Documentation of the demonstration
- 13.4.1. A demonstration report shall document the demonstration of the minimum acceptable reagent concentration. The report shall:
- identify the failures examined;
 - describe the demonstration performed including the applicable test cycle;
 - confirm that the pollutant emissions arising from this demonstration did not exceed the NO_x threshold specified in point 7.1.1;
 - be included in the information folder as set out in Part A of Annex I to Implementing Regulation (EU) 2017/656.

▼B*Appendix 2***Additional technical requirements on NO_x control measures for engines of categories IWP, IWA and RLR, including the method to demonstrate these strategies****1. Introduction**

This Appendix sets out the additional requirements to ensure the correct operation of NO_x control measures for engines of categories IWP, IWA and RLR.

▼M2**2. General requirements**

The requirements of Appendix 1 apply to engines in scope of this Appendix, except as set out in points 3 and 4 of this Appendix.

3. Exceptions to the requirements of Appendix 1

In order to account for safety concerns the operator inducement system set out in points 5 and 11.3 of Appendix 1 shall not apply to engines under the scope of this Appendix. The requirement to store data in an on-board computer log set out in point 4 of this Appendix shall apply wherever the inducement would have been activated in accordance with points 2.3.2.3.2, 6.3, 7.3, 8.4 and 9.4 of Appendix 1.

4. Requirement for storing incidents of engine operation with inadequate reagent injection or reagent quality

4.1. The on-board computer log must record in non-volatile computer memory or counters the total number and duration of all incidents of engine operation with inadequate reagent injection or reagent quality in a manner to ensure that the information cannot be intentionally deleted.

4.1.1. It shall be possible for national inspection authorities to read these records with a scan tool.

4.1.2. A description of the connection for, and method to read, these records shall be included in the information folder as set out in Part A of Annex I of Implementing Regulation (EU) 2017/656.

4.2. The duration of an incident of inadequate reagent level recorded in the on-board computer log as specified in point 4.1, in place of an inducement in accordance with point 6.3 of Appendix 1, shall commence when the reagent tank becomes empty, that is, when the dosing system is unable to draw further reagent from the tank, or at any level below 2,5 % of its nominally full capacity at the discretion of the manufacturer.

4.3. The duration of an incident recorded in the on-board computer log as specified in point 4.1, in place of the inducement specified in points 6.3, 7.3, 8.4 and 9.4 of Appendix 1, shall commence when the respective counter reaches the value for severe inducement in Table 4.4 of Appendix 1.

4.4. The duration of an incident recorded in the on-board computer log as specified in point 4.1, in place of the inducement specified in point 2.3.2.3.2 of Appendix 1, shall commence when inducement would have commenced.

▼ M2

- 4.5. The duration of an incident recorded in the on-board computer log as specified in point 4.1 shall end when the incident has been remedied.
- 4.6. When conducting a demonstration pursuant to section 10.4 of Appendix 1, the demonstration shall be conducted in accordance with the requirements applicable to demonstration of the severe inducement system, but the demonstration of severe inducement system shall be replaced by a demonstration of the storage of an incident of engine operation with inadequate reagent injection or reagent quality.

*Appendix 3***Additional technical requirements on NO_x control measures for engines of category RLL****1. Introduction**

This Appendix sets out the additional requirements to ensure the correct operation of NO_x control measures for engines of category RLL. It includes requirements for engines that rely on the use of a reagent in order to reduce emissions. The EU type-approval shall be made conditional upon the application of the relevant provisions on operator instruction, installation documents and operator warning system that are set out in this Appendix.

2. Required information

- 2.1. The manufacturer shall provide information that fully describes the functional operational characteristics of the NO_x control measures, in accordance with point 1.5 of Part A of Annex I to Implementing Regulation (EU) 2017/656.
- 2.2. If the emission control system requires a reagent, the characteristics of that reagent, including the type of reagent, information on concentration when the reagent is in solution, operational temperature conditions and reference to international standards for composition and quality must be specified by the manufacturer, in the information document set out in Appendix 3 of Annex I to Implementing Regulation (EU) 2017/656.

3. Reagent availability and operator warning system

When a reagent is used the EU type-approval shall be conditional upon providing indicators or other appropriate means, according to the configuration of the non-road mobile machinery, informing the operator on:

- (a) the amount of reagent remaining in the reagent storage container and by an additional specific signal, when the remaining reagent is less than 10 % of the full container's capacity;
- (b) when the reagent container becomes empty, or almost empty;
- (c) when the reagent in the storage tank does not comply with the characteristics declared and recorded in the information document set out in Appendix 3 of Annex I to Implementing Regulation (EU) 2017/656, in accordance with the installed means of assessment.
- (d) when the dosing activity of the reagent is interrupted, in cases other than those executed by the engine ECU or the dosing controller, reacting to engine operating conditions where the dosing is not required, provided that these operating conditions are made available to the approval authority.

4. Reagent quality

By the choice of the manufacturer the requirements of reagent compliance with the declared characteristics and the associated NO_x emission tolerance shall be satisfied by one of the following means:

- (a) direct means, such as the use of a reagent quality sensor.

▼B

- (b) indirect means, such as the use of a NO_x sensor in the exhaust system to evaluate reagent effectiveness.
- (c) any other means, provided that its efficacy is at least equal to the one resulting by the use of the means of points (a) or (b) and the main requirements of this section 4 are maintained.

▼ B*Appendix 4***Technical requirements on particulate pollutant control measures, including the method to demonstrate these measures****1. Introduction**

This Appendix sets out the requirements to ensure the correct operation of particulate control measures.

2. General requirements

The engine shall be equipped with a Particulate Control Diagnostic system (PCD) able to identify the particulate after-treatment system malfunctions considered by this Annex. Any engine covered by this section 2 shall be designed, constructed and installed so as to be capable of meeting these requirements throughout the normal life of the engine under normal conditions of use. In achieving this objective it is acceptable that engines which have been used in excess of the emission durability period as specified in Annex V to Regulation (EU) 2016/1628 show some deterioration in the performance and the sensitivity of the PCD.

2.1. Required information

2.1.1. If the emission control system requires a reagent e.g. fuel borne catalyst, the characteristics of that reagent, including the type of reagent, information on concentration when the reagent is in solution, operational temperature conditions and reference to international standards for composition and quality must be specified by the manufacturer, in the information document set out in Appendix 3 to Annex I to Implementing Regulation (EU) 2017/656.

2.1.2. Detailed written information fully describing the functional operation characteristics of the operator warning system in section 4 shall be provided to the approval authority at the time of EU type-approval.

2.1.3. The manufacturer shall provide installation documents that, when used by the OEM, will ensure that the engine, inclusive of the emission control system that is part of the approved engine type or engine family, when installed in the non-road mobile machinery, will operate, in conjunction with the necessary machinery parts, in a manner that will comply with the requirements of this Annex. This documentation shall include the detailed technical requirements and the provisions of the engine (software, hardware, and communication) needed for the correct installation of the engine in the non-road mobile machinery.

2.2. Operating conditions**▼ M2**

2.2.1. The PCD system shall, at a minimum, be operational at the applicable control conditions set out in point 2.4 of Annex IV for each engine category. The diagnostic system shall remain operational outside of this range where technically possible.

▼ B**2.3. Diagnostic requirements**

2.3.1. The PCD system shall be able to identify the particulate control malfunctions (PCM) considered by this Annex by means of Diagnostic Trouble Codes (DTCs) stored in the computer memory and to communicate that information off-board upon request.

▼B

- 2.3.2. Requirements for recording Diagnostic Trouble Codes (DTCs)
- 2.3.2.1. The PCD system shall record a DTC for each distinct PCM.
- 2.3.2.2. The PCD system shall conclude within the periods of engine operation indicated in Table 4.5 whether a detectable malfunction is present. At this time, a 'confirmed and active' DTC shall be stored and the warning system specified in section 4 shall be activated.

▼M2

- 2.3.2.3. In cases where more than the period of running time indicated in Table 4.5 is required for the monitors to accurately detect and confirm a PCM (e.g. monitors using statistical models or with respect to fluid consumption on the non-road mobile machinery), the approval authority may permit a longer period for monitoring provided the manufacturer justifies the need for the longer period (for example by technical rationale, experimental results, in-house experience, etc.).

▼B

Table 4.5

Monitor types and corresponding period within which a 'confirmed and active' DTC shall be stored

Monitor type	Period of accumulated running time within which a 'confirmed and active' DTC shall be stored
Removal of the particulate after-treatment system	60 minutes of non-idle engine operation
Loss of function of the particulate after-treatment system	240 minutes of non-idle engine operation
Failures of the PCD system	60 minutes of engine operation

- 2.3.3. Requirements for erasing Diagnostic trouble codes (DTCs):
- (a) DTCs shall not be erased by the PCD system itself from the computer memory until the failure related to that DTC has been remedied;
- (b) the PCD system may erase all the DTCs upon request of a proprietary scan or maintenance tool that is provided by the engine manufacturer upon request, or using a pass code provided by the engine manufacturer.
- (c) the record of incidents of operation with a DTC confirmed and active that are stored in non-volatile memory as required by point 5.2 shall not be erased.
- 2.3.4. A PCD system shall not be programmed or otherwise designed to partially or totally deactivate based on age of the non-road mobile machinery during the actual life of the engine, nor shall the system contain any algorithm or strategy designed to reduce the effectiveness of the PCD system over time.
- 2.3.5. Any reprogrammable computer codes or operating parameters of the PCD system shall be resistant to tampering.

▼ B

2.3.6. PCD engine family

The manufacturer is responsible for determining the composition of a PCD engine family. Grouping engines within a PCD engine family shall be based on good engineering judgment and be subject to approval by the approval authority.

Engines that do not belong to the same engine family may still belong to the same PCD engine family.

2.3.6.1. Parameters defining a PCD engine family

A PCD engine family is characterised by basic design parameters that shall be common to engines within the family.

In order that engines are considered to belong to the same PCD engine family, the following list of basic parameters shall be similar:

(a) working principle of particulate after-treatment system (e.g. mechanical, aerodynamic, diffusional, inertial, periodically regenerating, continuously regenerating, etc.)

(b) methods of PCD monitoring;

(c) criteria for PCD monitoring;

(d) monitoring parameters (e.g. frequency).

These similarities shall be demonstrated by the manufacturer by means of relevant engineering demonstration or other appropriate procedures and subject to the approval of the approval authority.

The manufacturer may request approval by the approval authority of minor differences in the methods of monitoring/diagnosing the PCD monitoring system due to engine configuration variation, when these methods are considered similar by the manufacturer and they differ only in order to match specific characteristics of the components under consideration (for example size, exhaust gas flow, etc.); or their similarities are based on good engineering judgment.

3. **Maintenance requirements****▼ M2**

3.1. The OEM shall provide to all end-users of new non-road mobile machinery written instructions about the emission control system and its correct operation as required in Annex XV.

▼ B4. **Operator warning system**

4.1. The non-road mobile machinery shall include an operator warning system using visual alarms.

4.2. The operator warning system may consist of one or more lamps, or display short messages.

The system used for displaying these messages may be the same as the one used for other maintenance or NCD purposes

▼ B

The warning system shall indicate that an urgent repair is required. When the warning system includes a message display system, it shall display a message indicating the reason of the warning (for example 'sensor disconnected', or 'critical emission failure')

- 4.3. At the choice of the manufacturer, the warning system may include an audible component to alert the operator. The cancelling of audible warnings by the operator is permitted.
- 4.4. The operator warning system shall be activated as specified in point 2.3.2.2.
- 4.5. The operator warning system shall be deactivated when the conditions for its activation have ceased to exist. The operator warning system shall not be automatically deactivated without the reason for its activation having been remedied.
- 4.6. The warning system may be temporarily interrupted by other warning signals providing important safety related messages.
- 4.7. In the application for EU type-approval under Regulation (EU) 2016/1628, the manufacturer shall demonstrate the operation of the operator warning system, as specified in Section 9.

5. **System to store information on operator warning system activation**

- 5.1. The PCD system shall include a non-volatile computer memory or counters to store incidents of engine operation with a DTC confirmed and active in a manner to ensure that the information cannot be intentionally deleted.
- 5.2. The PCD shall store in the non-volatile memory the total number and duration of all incidents of engine operation with a DTC confirmed and active where the operator warning system has been active for 20 hours of engine operation, or a shorter period at the choice of the manufacturer.
- 5.3. It shall be possible for national authorities to read these records with a scan tool.

▼ M2

- 5.4. A description of the connection for, and method to read, these records shall be included in the information folder as set out in Part A of Annex I of Implementing Regulation (EU) 2017/656.

▼ B

6. **Monitoring for removal of the particulate after-treatment system**

▼ M2

- 6.1. The PCD system shall detect the complete removal of the particulate after-treatment system inclusive of the removal of any sensors used to monitor, activate, de-activate or modulate its operation.

▼ B

7. **Additional requirements in the case of a particulate after-treatment system that uses a reagent (e.g. fuel-borne catalyst)**

- 7.1. In the case of a confirmed and active DTC for either removal of the particulate after-treatment system or loss of the particulate after-treatment system function the reagent dosing shall be immediately interrupted. Dosing shall re-commence when the DTC is no longer active.
- 7.2. The warning system shall be activated if the reagent level in the additive tank falls below the minimum value specified by the manufacturer.

▼B

8. **Monitoring failures that may be attributed to tampering**
- 8.1. In addition to monitoring for removal of the particulate after-treatment system the following failures shall be monitored because they may be attributed to tampering:
- (a) loss of the particulate after-treatment system function,
- (b) failures of the PCD system, as described in point 8.3.
- 8.2. Monitoring of loss of the particulate after-treatment system function
- The PCD shall detect the complete removal of the particulate after-treatment system substrate ('empty can'). In this case the particulate after-treatment system housing and sensors used to monitor, activate, de-activate or modulate its operation are still present.
- 8.3. Monitoring of failures of the PCD system
- 8.3.1. The PCD system shall be monitored for electrical failures and for removal or deactivation of any sensor or actuator that prevents it from diagnosing any other failures mentioned in point 6.1 and 8.1(a) (component monitoring).

A non-exhaustive list of sensors that affect the diagnostic capability are those directly measuring differential pressures over the particulate after-treatment system and exhaust gas temperature sensors for controlling the particulate after-treatment system regeneration.

- 8.3.2. Where the failure, removal or deactivation of a single sensor or actuator of the PCD system does not prevent the diagnosis within the required time period of the failures mentioned in point 6.1 and 8.1(a) (redundant system), the activation of the warning system and storage of information on operator warning system activation shall not be required unless additional sensor or actuator failures are confirmed and active.

9. **Demonstration requirements**

- 9.1. General
- The compliance to the requirements of this Appendix shall be demonstrated during EU type-approval by performing, as illustrated in Table 4.6 and specified in this section 9 a demonstration of the warning system activation.

Table 4.6

Illustration of the content of the demonstration process in accordance with the provisions in point 9.3.

Mechanism	Demonstration elements
Warning system activation specified in point 4.4.	<ul style="list-style-type: none"> — 2 activation tests (incl. loss of the particulate after-treatment system function) — Supplementary demonstration elements, as appropriate

▼ B

9.2. Engine families and PCD engine families

▼ M2

- 9.2.1. In the case where engines of an engine family belong to a PCD engine family that has already been EU type-approved, in accordance with point 2.3.6 (Figure 4.8), the compliance of that engine family is deemed to be demonstrated without further testing, provided the manufacturer demonstrates to the authority that the monitoring systems necessary for complying with the requirements of this Appendix are similar within the considered engine and PCD engine families.

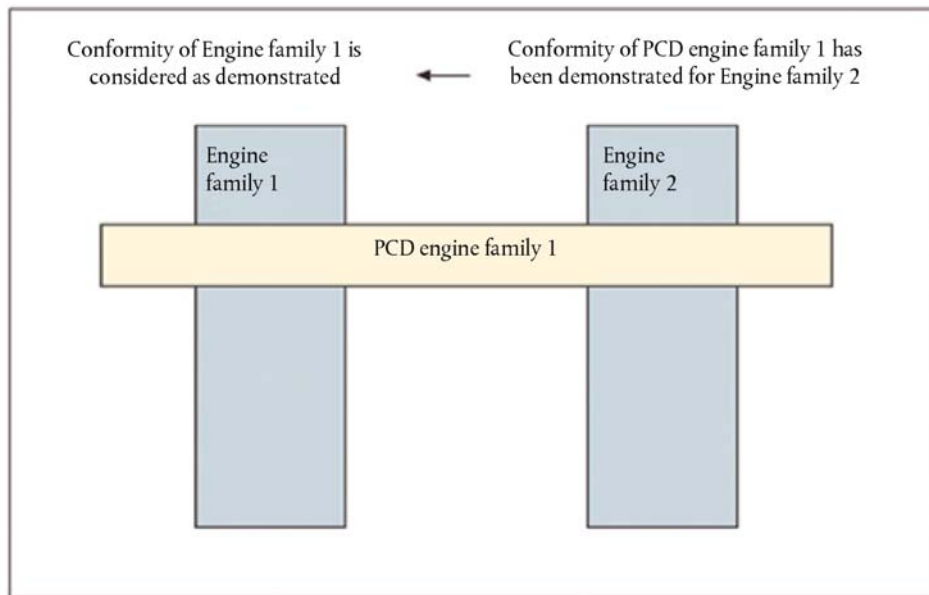
*Figure 4.8***Previously demonstrated conformity of a PCD engine family****▼ B**

9.3. Demonstration of the warning system activation

- 9.3.1. The compliance of the warning system activation shall be demonstrated by performing two tests: loss of the particulate after-treatment system function and one failure category considered in point 6 or point 8.3 of this Annex.
- 9.3.2. Selection of the failures to be tested
- 9.3.2.1. The manufacturer shall provide the approval authority with a list of such potential failures.
- 9.3.2.2. The failure to be considered in the test shall be selected by the approval authority from this list referred to in point 9.3.2.1.
- 9.3.3. Demonstration
- 9.3.3.1. For the purpose of this demonstration, a separate test shall be performed for the loss of the particulate after-treatment system function set out in point 8.2 and for the failures laid down in points 6 and 8.3. The loss of the particulate after-treatment system function shall be created by a complete removal of the substrate from the particulate after-treatment system housing.
- 9.3.3.2. During a test, no failure shall be present other than the one addressed by the test.

▼ B

- 9.3.3.3. Prior to starting a test, all DTC shall have been erased.
- 9.3.3.4. At the request of the manufacturer, and with the agreement of the approval authority, the failures subject to testing may be simulated.
- 9.3.3.5. Detection of failures
- 9.3.3.5.1. The PCD system shall respond to the introduction of a failure selected as appropriate by the approval authority in accordance to the provisions of this Appendix. This is considered to be demonstrated if activation occurs within the number of consecutive PCD test-cycles given in Table 4.7.

When it has been specified in the monitoring description and agreed by the approval authority that a specific monitor needs more PCD test-cycles to complete its monitoring than indicated in Table 4.7, the number of PCD test-cycles may be increased by up to 50 %.

Each individual PCD test-cycle in the demonstration test may be separated by an engine shut-off. The time until the next start-up shall take into consideration any monitoring that may occur after engine shut-off and any necessary condition that must exist for monitoring to occur at the next start-up.

Table 4.7

Monitor types and corresponding number of PCD test cycles within which a 'confirmed and active' DTC shall be stored

Monitor type	Number of PCD test cycles within which a 'confirmed and active' DTC shall be stored
Removal of the particulate after-treatment system	2
Loss of function of the particulate after-treatment system	8
Failures of the PCD system	2

- 9.3.3.6. PCD test cycle
- 9.3.3.6.1. The PCD test cycle considered in this Section 9 for demonstrating the correct performance of the particulate after-treatment system monitoring system is the hot-start NRTC cycle for engines of sub-category NRE-v-3, NRE-v-4, NRE-v-5, NRE-v-6 and the applicable NRSC for all other categories.
- 9.3.3.6.2. On request of the manufacturer and with approval of the approval authority, an alternative PCD test-cycle (e.g. other than the NRTC or the NRSC) can be used for a specific monitor. The request shall contain elements (technical considerations, simulation, test results, etc.) demonstrating:

▼ M2

- (a) the requested test-cycle results in a monitor that will run in real world operation conditions; and

▼ B

- (b) the applicable PCD test-cycle specified in point 9.3.3.6.1 is less appropriate for the considered monitoring.
- 9.3.3.7 Configuration for demonstration of the warning system activation
 - 9.3.3.7.1. The demonstration of the warning system activation shall be done by tests performed on an engine test bench.
 - 9.3.3.7.2. Any components or subsystems not physically mounted on the engine, such as, but not limited to, ambient temperature sensors, level sensors, and operator warning and information systems, that are required in order to perform the demonstrations shall be connected to the engine for that purpose, or shall be simulated, to the satisfaction of the approval authority.
 - 9.3.3.7.3. If the manufacturer chooses, and subject to the agreement of the approval authority, the demonstration tests may be performed, notwithstanding point 9.3.3.7.1, on a complete non-road mobile machinery or machinery either by mounting the non-road mobile machinery on a suitable test bed or by running it on a test track under controlled conditions.
- 9.3.4. The demonstration of the warning system activation is deemed to be accomplished if, at the end of each demonstration test performed in accordance with point 9.3.3 the warning system has been properly activated and the DTC for the selected failure has a ‘confirmed and active’ status.
- 9.3.5 Where a particulate after-treatment system that uses a reagent is subjected to a demonstration test for loss of the particulate after-treatment system function or removal of the particulate after-treatment system it shall also be confirmed that reagent dosing has been interrupted.

▼ M2

- 9.3.6. Documentation of the demonstration
 - 9.3.6.1. A demonstration report shall document the demonstration of the PCD system. The report shall:
 - (a) identify the failures examined;
 - (b) describe the demonstration performed including the applicable test cycle;
 - (c) confirm that the applicable warnings were activated as required by this regulation;
 - (d) be included in the information folder as set out in Part A of Annex I to Implementing Regulation (EU) 2017/656.

▼ B*ANNEX V***Measurements and tests with regard to the area associated with the non-road steady-state test cycle****1. General requirements**

This Annex shall apply for electronically controlled engines of categories NRE, NRG, IWP, IWA, and RLR, complying with 'Stage V' emission limits set out in Annex II to Regulation (EU) 2016/1628 and using electronic control to determine both the quantity and timing of injecting fuel or using electronic control to activate, de-activate or modulate the emission control system used to reduce NO_x.

▼ M2

This Annex sets out the technical requirements relating to the area associated with the relevant NRSC, within which the amount by which the emissions shall be permitted to exceed the emission limits set out in Annex II to Regulation (EU) 2016/1628 is controlled.

When an engine is tested in the manner set out in test requirements of section 4 the emission of gaseous and particulate pollutants sampled at any randomly selected point within the applicable control area set out in section 2 shall not exceed the applicable emission limit values in Annex II to Regulation (EU) 2016/1628 multiplied by a factor of 2,0.

▼ B

Section 3 sets out the selection by the technical service of additional measurement points from within the control area during the emission bench test, in order to demonstrate that the requirements of this section 1 have been met.

The manufacturer may request that the Technical Service excludes operating points from any of the control areas set out in section 2 during the demonstration set out in section 3. The Technical Service may grant this exclusion if the manufacturer can demonstrate that the engine is never capable of operating at such points when used in any non-road mobile non-road mobile machinery combination.

▼ M2

The installation instructions provided by the manufacturer to the OEM in accordance with Annex XIV shall identify the upper and lower boundaries of the applicable control area and shall include a statement to clarify that the OEM shall not install the engine in such a way that it constrains the engine to operate permanently at only combinations of speed and torque outside of the control area for the torque curve corresponding to the approved engine type or engine family.

▼ B**2. Engine control area**

The applicable control area for conducting the engine test shall be the area identified in this section 2 that corresponds to the applicable NRSC for the engine being tested.

2.1. Control area for engines tested on NRSC cycle C1

These engines operate with variable-speed and load. Different control area exclusions apply depending upon the (sub-)category and operating speed of the engine.

▼ B

2.1.1. Variable-speed engines of category NRE with maximum net power ≥ 19 kW, variable-speed engines of category IWA with maximum net power ≥ 300 kW, variable-speed engines of category RLR and variable-speed engines of category NRG.

The control area (see Figure 5.1) is defined as follows:

upper torque limit: full load torque curve;

speed range: speed A to n_{hi} ;

where:

speed A = $n_{lo} + 0,15 \times (n_{hi} - n_{lo})$;

n_{hi} = high speed [see Article 1(12)];

n_{lo} = low speed [see Article 1(13)].

The following engine operating conditions shall be excluded from testing:

- (a) points below 30 % of maximum torque;
- (b) points below 30 % of maximum net power.

If the measured engine speed A is within $\pm 3\%$ of the engine speed declared by the manufacturer, the declared engine speeds shall be used. If the tolerance is exceeded for any of the test speeds, the measured engine speeds shall be used.

Intermediate test points within the control area shall be determined as follows:

%torque = % of maximum torque;

$$\%speed = \frac{(n - n_{idle})}{(n_{100\%} - n_{idle})} \cdot 100;$$

where: $n_{100\%}$ is the 100 % speed for the corresponding test cycle.

Figure 5.1

Control area for variable-speed engines of category NRE with maximum net power ≥ 19 kW, variable-speed engines of category IWA with maximum net power ≥ 300 kW and variable-speed engines of category NRG

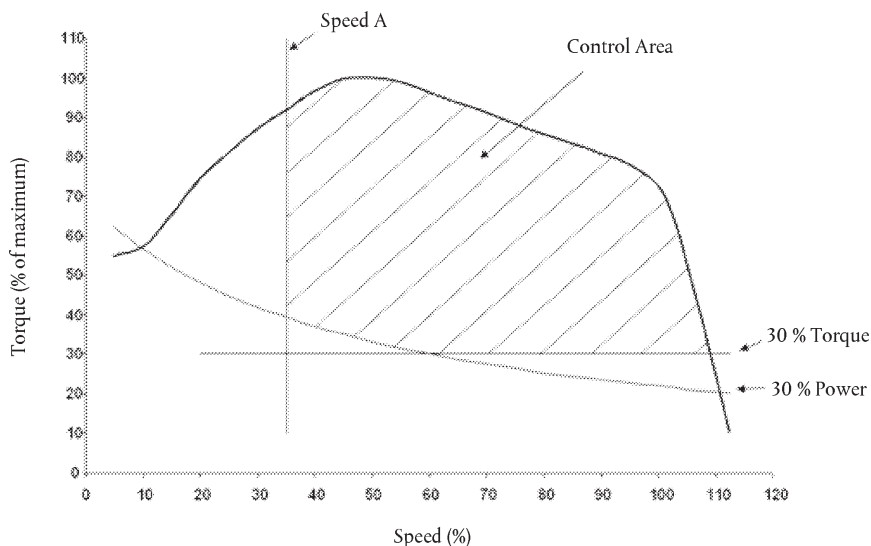

▼ B

- 2.1.2. Variable-speed engines of category NRE with maximum net power < 19 kW and variable-speed engines of category IWA with maximum net power < 300 kW

The control area specified in point 2.1.1 shall apply but with the additional exclusion of the engine operating conditions given in this point and illustrated in Figures 5.2 and 5.3.

- (a) for particulate matter only, if the C speed is below 2 400 r/min, points to the right of or below the line formed by connecting the points of 30 % of maximum torque or 30 % of maximum net power, whichever is greater, at the B speed and 70 % of maximum net power at the high speed;
- (b) for particulate matter only, if the C speed is at or above 2 400 r/min, points to the right of the line formed by connecting the points of 30 % of maximum torque or 30 % of maximum net power, whichever is greater, at the B speed, 50 % of maximum net power at 2 400 r/min, and 70 % of maximum net power at the high speed.

where:

$$\text{speed B} = n_{lo} + 0,5 \times (n_{hi} - n_{lo});$$

$$\text{speed C} = n_{lo} + 0,75 \times (n_{hi} - n_{lo}).$$

n_{hi} = high speed [see Article 1(12)],

n_{lo} = low speed [see Article 1(13)],

If the measured engine speeds A, B and C are within $\pm 3\%$ of the engine speed declared by the manufacturer, the declared engine speeds shall be used. If the tolerance is exceeded for any of the test speeds, the measured engine speeds shall be used.

▼ M2

Figure 5.2

Control area for variable-speed engines of category NRE with maximum net power < 19 kW and variable-speed engines of category IWA with maximum net power < 300 kW, speed C < 2 400 rpm

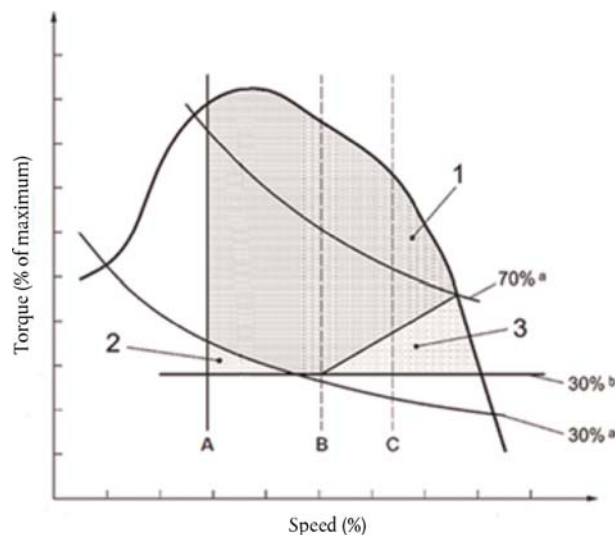

▼ M2**Key**

- 1 Engine Control Area
- 2 All Emissions Carve-Out
- 3 PM Carve-Out
- ^a % of maximum net power
- ^b % of maximum torque

Figure 5.3

Control area for variable-speed engines of category NRE with maximum net power < 19 kW and variable-speed engines of category IWA with maximum net power < 300 kW, speed $C \geq 2\,400$ rpm

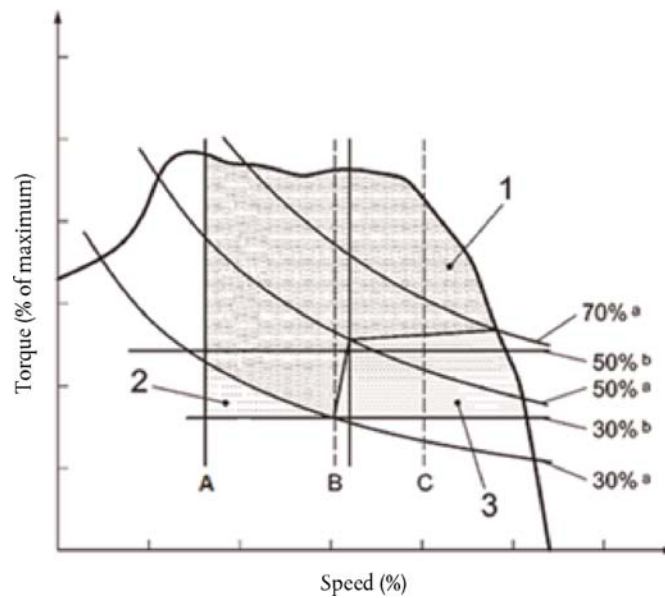
**Key**

- 1 Engine Control Area
- 2 All Emissions Carve-Out
- 3 PM Carve-Out
- ^a Percent of maximum net power
- ^b Percent of maximum torque

▼ B

- 2.2. Control area for engines tested on NRSC cycles D2, E2 and G2

These engines are mainly operated very close to their designed operating speed, hence the control area is defined as:

speed: 100 %

torque range: 50 % to the torque corresponding to maximum power.

▼B

2.3. Control area for engines tested on NRSC cycle E3

These engines are mainly operated slightly above and below a fixed pitch propeller curve. The control area is related to the propeller curve and has exponents of mathematical equations defining the boundaries of the control area. The control area is defined as follows:

Lower speed limit: $0,7 \times n_{100} \%$

Upper boundary curve: $\%power = 100 \times (\%speed/90)^{3,5}$;

Lower boundary curve: $\%power = 70 \times (\%speed/100)^{2,5}$;

Upper power limit: Full load power curve

Upper speed limit: Maximum speed permitted by governor

where:

$\%power$ is % of maximum net power;

$\%speed$ is % of $n_{100} \%$

$n_{100} \%$ is the 100 % speed for the corresponding test cycle.

Figure 5.4

Control area for engines tested on NRSC cycle E3

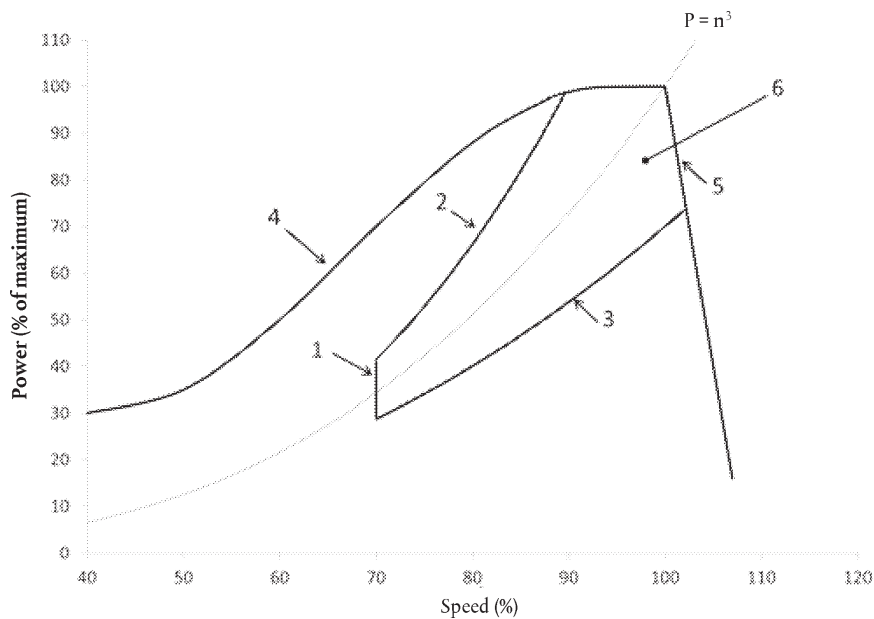

Key:

- 1 Lower speed limit
- 2 Upper boundary curve
- 3 Lower boundary curve
- 4 Full load power curve
- 5 Governor maximum speed curve
- 6 Engine Control Area

▼ B**3. Demonstration requirements**

The technical service shall select random load and speed points within the control area for testing. For engines subject to point 2.1 up to three points shall be selected. For engines subject to point 2.2 one point shall be selected. For engines subject to points 2.3 or 2.4 up to two points shall be selected. The technical service shall also determine a random running order of the test points. The test shall be run in accordance with the principal requirements of the NRSC, but each test point shall be evaluated separately.

▼ M2

- 3.1. For the purpose of the random selections required in point 3, acknowledged statistical methods of randomization shall be used.

▼ B**4. Test requirements****▼ M2**

The test shall be carried out immediately after the applicable NRSC as follows:

- (a) the test of the randomly selected torque and speed points shall either be carried out immediately after the discrete-mode NRSC test sequence described in points (a) to (e) of point 7.8.1.2 of Annex VI but before the post test procedures (f) or after the ramped modal non-road steady-state test cycle ('RMC') test sequence described in points (a) to (d) of point 7.8.2.3 of Annex VI but before the post test procedures (e) as relevant;

▼ B

- (b) the tests shall be carried out as required in points (b) to (e) of point 7.8.1.2 of Annex VI using the multiple filter method (one filter for each test point) for each of the test points chosen in accordance with section 3;

- (c) a specific emission value shall be calculated (in g/kWh or #/kWh as applicable) for each test point;

- (d) emissions values may be calculated on a mass basis using section 2 of Annex VII or on a molar basis using section 3 of Annex VII, but shall be consistent with the method used for the discrete-mode NRSC or RMC test;

▼ M2

- (e) for gaseous and PN, if applicable, summation calculations, N_{mode} in equations (7-64) or (7-131) and (7-178) shall be set to 1 and a weighting factor of 1 shall be used;

- (f) for PM calculations the multiple filter method shall be used; for summation calculations, N_{mode} in equations (7-67) or (7-134) shall be set to 1 and a weighting factor of 1 shall be used.

5. Regeneration

In the case that a regeneration event occurs during or immediately preceding the procedure set out in point 4, upon completion of that procedure the test may be voided at the request of the manufacturer, irrespective of the cause of the regeneration. In this case the test shall be repeated. The same torque and speed points shall be used although the running order may be changed. It shall not be deemed necessary to repeat any torque and speed points for which a pass result has already been obtained. The following procedure shall be used for repeating the test:

▼ **M2**

- (a) The engine shall be operated in a manner to ensure that the regeneration event has completed and, where applicable, the soot load in the particulate after-treatment system has been re-established;
- (b) The engine warm-up procedure shall be performed in accordance with point 7.8.1.1 of Annex VI;
- (c) The test procedure specified in point 4 shall be repeated commencing at the stage referred to in point 4(b).

▼B*ANNEX VI***Conduct of emission tests and requirements for measurement equipment****▼M2****1. Introduction**

This Annex describes the method of determining emissions of gaseous and particulate pollutants from the engine to be tested and the specifications related to the measurement equipment. As from section 6, the numbering of this Annex is consistent with the numbering of the Global technical regulation No 11 ⁽¹⁾ (GTR No 11) and UNECE Regulation No 96.04 series of amendments ⁽²⁾, Annex 4B. However, some points of the GTR No 11 are not needed in this Annex, or are modified in accordance with the technical progress.

▼B**2. General overview**

This Annex contains the following technical provisions needed for conducting an emissions test. Additional provisions are listed in point 3.

- Section 5: Performance requirements, including the determination of tests speeds
- Section 6: Test conditions, including the method for accounting for emissions of crankcase gases, the method for determining and accounting for continuous and infrequent regeneration of exhaust after-treatment systems
- Section 7: Test procedures, including the mapping of engines, the test cycle generation and the test cycle running procedure
- Section 8: Measurement procedures, including the instrument calibration and performance checks and the instrument validation for the test
- Section 9: Measurement equipment, including the measurement instruments, the dilution procedures, the sampling procedures and the analytical gases and mass standards
- Appendix 1: PN measurement procedure

3. Related annexes

- Data evaluation and calculation: Annex VII
- Test procedures for dual-fuel engines: Annex VIII
- Reference fuels: Annex IX
- Test cycles: Annex XVII

⁽¹⁾ Global technical regulation No 11 on Engine Emissions from agricultural and forestry tractors and from non-road mobile machinery under the Global Registry created on 18 November 2004, pursuant to Article 6 of the Agreement concerning the establishing of global technical regulations for wheeled vehicles, equipment and parts which can be fitted and/or be used on wheeled vehicles.

⁽²⁾ Regulation No 96 of the Economic Commission for Europe of the United Nations (UN/ECE) — Uniform provisions concerning the approval of compression ignition (C.I.) engines to be installed in agricultural and forestry tractors and in non-road mobile machinery with regard to the emissions of pollutants by the engine.

▼ B**4. General requirements**

The engines to be tested shall meet the performance requirements set out in section 5 when tested in accordance with the test conditions set out in section 6 and the test procedures set out in section 7.

5. Performance requirements**5.1. Emissions of gaseous and particulate pollutants and of CO₂ and NH₃**

The pollutants are represented by:

- (a) Oxides of nitrogen, NO_x;
- (b) Hydrocarbons, expressed as total hydrocarbons, HC or THC;
- (c) Carbon monoxide, CO;
- (d) Particulate matter, PM;
- (e) Particle number, PN.

▼ M2

The measured values of gaseous and particulate pollutants and of CO₂ exhausted by the engine refer to the brake-specific emissions in grams per kilowatt-hour (g/kWh), or number per kilowatt-hour (#/kWh) for PN.

The gaseous and particulate pollutants that shall be measured are those for which limit values are applicable to the engine sub-category being tested as set out in Annex II to Regulation (EU) 2016/1628. The results, inclusive of:

- (a) the crankcase emissions determined in accordance with section 6.10, if relevant,
- (b) the adjustment factors for infrequent regeneration of the after-treatment system determined in accordance with section 6.6, if relevant, and
- (c) as the final step of the calculation, the deterioration factor determined in accordance with Annex III,

shall not exceed the applicable limit values.

The CO₂ shall be measured and reported for all engine sub-categories as required by Article 43(4) of Regulation (EU) 2016/1628.

▼ B

The mean emission of ammonia (NH₃) shall additionally be measured, as required in accordance with section 3 of Annex IV, when the NO_x control measures that are part of the engine emission control system include use of a reagent, and shall not exceed the values set out in that section.

The emissions shall be determined on the duty cycles (steady-state and/or transient test cycles), as described in section 7 and in Annex XVII. The measurement systems shall meet the calibration and performance checks set out in section 8 with the measurement equipment described in section 9.

▼B

Other systems or analysers may be approved by the approval authority if it is found that they yield equivalent results in accordance with point 5.1.1. The results shall be calculated according to the requirements of Annex VII.

5.1.1. Equivalency

The determination of system equivalency shall be based on a seven-sample pair (or larger) correlation study between the system under consideration and one of the systems of this annex. 'Results' refer to the specific cycle weighted emissions value. The correlation testing is to be performed at the same laboratory, test cell and on the same engine, and is preferred to be run concurrently. The equivalency of the sample pair averages shall be determined by F-test and t-test statistics as described in Appendix 3 of Annex VII, obtained under the laboratory, test cell and the engine conditions described above. Outliers shall be determined in accordance with ISO 5725 and excluded from the database. The systems to be used for correlation testing shall be subject to the approval by the approval authority.

5.2. General requirements on the test cycles

5.2.1. The EU type-approval test shall be conducted using the appropriate NRSC and, where applicable, NRTC or LSI-NRTC, as specified in Article 24 and Annex IV to Regulation (EU) 2016/1628.

5.2.2. The technical specifications and characteristics of the NRSC are set out in Annex XVII, Appendix 1 (discrete-mode NRSC) and Appendix 2 (ramped-modal NRSC). At the choice of the manufacturer, a NRSC test may be run as a discrete-mode NRSC or, where available, as a ramped-modal NRSC ('RMC') as set out in point 7.4.1.

5.2.3. The technical specifications and characteristics of the NRTC and LSI-NRTC are set out in Appendix 3 of Annex XVII.

5.2.4. The test cycles specified in point 7.4 and in Annex XVII are designed around percentages of maximum torque or power and test speeds that need to be determined for the correct performance of the test cycles:

(a) 100 % speed (maximum test speed (MTS) or rated speed)

(b) Intermediate speed(s) as specified in point 5.2.5.4;

(c) Idle speed, as specified in point 5.2.5.5.

The determination of the test speeds is set out in point 5.2.5, the use of torque and power in point 5.2.6.

5.2.5. Test speeds

5.2.5.1. Maximum test speed (MTS)

The MTS shall be calculated in accordance with point 5.2.5.1.1 or point 5.2.5.1.3.

▼ **M2**

5.2.5.1.1. Calculation of MTS

In order to calculate the MTS the transient mapping procedure shall be performed in accordance with point 7.4. The MTS is then determined from the mapped values of engine speed versus power. MTS shall be calculated by means of one of the following options:

(a) Calculation based upon low speed and high speed values

$$\text{MTS} = n_{lo} + 0,95 \cdot (n_{hi} - n_{lo}) \quad (6-1)$$

where:

n_{hi} is the high speed as defined in Article 1(12),

n_{lo} is the low speed as defined in Article 1(13).

(b) Calculation based upon the longest vector method

$$\text{MTS} = n_i \quad (6-2)$$

where:

n_i is the average of the lowest and highest speeds at which $(n_{normi}^2 + P_{normi}^2)$ is equal to 98 % of the maximum value of $(n_{normi}^2 + P_{normi}^2)$

If there is only one speed at which the value of $(n_{normi}^2 + P_{normi}^2)$ is equal to 98 % of the maximum value of $(n_{normi}^2 + P_{normi}^2)$:

$$\text{MTS} = n_i \quad (6-3)$$

where:

n_i is the speed at which the maximum value of $(n_{normi}^2 + P_{normi}^2)$ occurs.

where:

n is the engine speed

i is an indexing variable that represents one recorded value of an engine map

n_{normi} is an engine speed normalized by dividing it by $n_{p_{max}}$

P_{normi} is an engine power normalized by dividing it by P_{max}

$n_{p_{max}}$ is the average of the lowest and highest speeds at which power is equal to 98 % of P_{max} .

Linear interpolation shall be used between the mapped values to determine:

- (i) the speeds where power is equal to 98 % of P_{max} . If there is only one speed at which power is equal to 98 % of P_{max} , $n_{p_{max}}$ shall be the speed at which P_{max} occurs;

▼ M2

- (ii) the speeds where $(n_{\text{normi}}^2 + P_{\text{normi}}^2)$ is equal to 98 % of the maximum value of $(n_{\text{normi}}^2 + P_{\text{normi}}^2)$.

▼ B

5.2.5.1.2. Use of a declared MTS

If the MTS calculated in accordance with point 5.2.5.1.1 or 5.2.5.1.3 is within $\pm 3\%$ of the MTS declared by the manufacturer, the declared MTS may be used for the emissions test. If the tolerance is exceeded, the measured MTS shall be used for the emissions test.

5.2.5.1.3. Use of an adjusted MTS

If the falling part of the full load curve has a very steep edge, this may cause problems to drive the 105 % speeds of the NRTC correctly. In this case it is allowed, with prior agreement of the technical service, to use an alternative value of MTS determined using one of the following methods:

- (a) the MTS may be slightly reduced (maximum 3 %) in order to make correct driving of the NRTC possible.
- (b) Calculate an alternative MTS by means of equation (6-4):

$$\text{MTS} = ((n_{\text{max}} - n_{\text{idle}})/1,05) + n_{\text{idle}} \quad (6-4)$$

where:

n_{max} = is the engine speed at which the engine governor function controls engine speed with operator demand at maximum and with zero load applied ('maximum no-load speed')

n_{idle} = is the idle speed

5.2.5.2. Rated speed

▼ M2

The rated speed is defined in Article 3(29) of Regulation (EU) 2016/1628. Rated speed for variable-speed engines subject to an emission test other than those tested on a constant-speed NRSC defined in Article 1(31) of this Regulation shall be determined from the applicable mapping procedure set out in point 7.6 of this Annex. Rated speed for variable-speed engines tested on a constant-speed NRSC shall be declared by the manufacturer according to the characteristics of the engine. Rated speed for constant-speed engines shall be declared by the manufacturer according to the characteristics of the governor. Where an engine type equipped with alternative speeds as permitted by Article 3(21) of Regulation (EU) 2016/1628 is subject to an emission test, each alternative speed shall be declared and tested.

▼ B

If the rated speed determined from the mapping procedure in section 7.6 is within ± 150 rpm of the value declared by the manufacturer for engines of category NRS provided with governor, or within ± 350 rpm or $\pm 4\%$ for engines of category

▼ B

NRS without governor, whichever is smaller, or within ± 100 rpm for all other engine categories, the declared value may be used. If the tolerance is exceeded, the rated speed determined from the mapping procedure shall be used.

▼ M2

For engines of category NRSh the 100 % test speed shall be within ± 350 rpm of the rated speed declared by the manufacturer.

▼ B

Optionally, MTS may be used instead of rated speed for any steady state test cycle.

5.2.5.3. Maximum torque speed for variable-speed engines

▼ M2

Where required, the maximum torque speed determined from the maximum torque curve established by the applicable engine mapping procedure in point 7.6.1 or 7.6.2 shall be one of the following:

▼ B

- (a) The speed at which the highest torque was recorded; or,
- (b) The average of the lowest and highest speeds at which the torque is equal to 98 % of the maximum torque. Where necessary, linear interpolation shall be used to determine the speeds at which the torque is equal to 98 % of the maximum torque.

If the maximum torque speed determined from the maximum torque curve is within ± 4 % of the maximum torque speed declared by the manufacturer for ►**M2** engines of category NRS ◀, or $\pm 2,5$ % of the maximum torque speed declared by the manufacturer for all other engine categories, the declared value may be used for the purpose of this regulation. If the tolerance is exceeded, the maximum torque speed determined from the maximum torque curve shall be used.

5.2.5.4. Intermediate speed

The intermediate speed shall meet one of the following requirements:

- (a) For engines that are designed to operate over a speed range on a full load torque curve, the intermediate speed shall be the maximum torque speed if it occurs between 60 % and 75 % of rated speed;
- (b) If the maximum torque speed is less than 60 % of rated speed, then the intermediate speed shall be 60 % of the rated speed;
- (c) If the maximum torque speed is greater than 75 % of the rated speed then the intermediate speed shall be 75 % of rated speed. Where the engine is only capable of operation at speeds higher than 75 % of rated speed the intermediate speed shall be the lowest speed at which the engine can be operated;

▼ B

- (d) For engines that are not designed to operate over a speed range on a full-load torque curve at steady-state conditions, the intermediate speed shall be between 60 % and 70 % of the rated speed.
- (e) For engines to be tested on cycle G1, except for engines of category ATS, the intermediate speed shall be 85 % of the rated speed.
- (f) For engines of category ATS tested on cycle G1 the intermediate speed shall be 60 % or 85 % of rated speed based on which is closer to the actual maximum torque speed.

Where the MTS is used in place of rated speed for the 100 % test speed, MTS shall also replace rated speed when determining the intermediate speed.

5.2.5.5. Idle speed

The idle speed is the lowest engine speed with minimum load (greater than or equal to zero load), where an engine governor function controls engine speed. For engines without a governor function that controls idle speed, idle speed means the manufacturer-declared value for lowest engine speed possible with minimum load. Note that warm idle speed is the idle speed of a warmed-up engine.

5.2.5.6. Test speed for constant-speed engines

The governors of constant-speed engines may not always maintain speed exactly constant. Typically speed can decrease (0,1 to 10) % below the speed at zero load, such that the minimum speed occurs near the engine's point of maximum power. The test speed for constant-speed engines may be commanded by using the governor installed on the engine or using a test-bed speed demand where this represents the engine governor.

▼ M2

Where the governor installed on the engine is used the 100 % speed shall be the engine governed speed as defined in Article 1(24).

▼ B

Where a test-bed speed demand signal is used to simulate the governor, the 100 % speed at zero load shall be the no-load speed specified by the manufacturer for that governor setting and the 100 % speed at full load shall be the rated speed for that governor setting. Interpolation shall be used to determine the speed for the other test modes.

Where the governor has an isochronous operation setting, or the rated speed and no-load speed declared by the manufacturer differ by no more than 3 %, a single value declared by the manufacturer may be used for the 100 % speed at all load points.

▼B

5.2.6. Torque and Power

5.2.6.1 Torque

The torque figures given in the test cycles are percentage values that represent, for a given test mode, one of the following:

- (a) The ratio of the required torque to the maximum possible torque at the specified test speed (all cycles except D2 & E2);
- (b) The ratio of the required torque to the torque corresponding to the rated net power declared by the manufacturer (cycle D2 & E2).

5.2.6.2. Power

The power figures given in the test cycles are percentage values that represent, for a given test mode, one of the following:

- (a) For the test cycle E3 the power figures are percentage values of the maximum net power at the 100 % speed as this cycle is based on a theoretical propeller characteristic curve for vessels driven by heavy-duty engines without limitation of length.
- (b) For the test cycle F the power figures are percentage values of the maximum net power at the given test speed, except for idle speed where it is a percentage of the maximum net power at the 100 % speed.

6. **Test Conditions**

6.1. Laboratory test conditions

The absolute temperature (T_a) of the engine air at the inlet to the engine expressed in Kelvin, and the dry atmospheric pressure (p_s), expressed in kPa shall be measured and the parameter f_a shall be determined in accordance with the following provisions and by means of equation (6-5) or (6-6). If the atmospheric pressure is measured in a duct, negligible pressure losses shall be ensured between the atmosphere and the measurement location, and changes in the duct's static pressure resulting from the flow shall be accounted for. In multi-cylinder engines having distinct groups of intake manifolds, such as in a 'V' engine configuration, the average temperature of the distinct groups shall be taken. The parameter f_a shall be reported with the test results.

Naturally aspirated and mechanically supercharged engines:

$$f_a = \left(\frac{99}{p_s}\right) \times \left(\frac{T_a}{298}\right)^{0,7} \quad (6-5)$$

Turbocharged engines with or without cooling of the intake air:

$$f_a = \left(\frac{99}{p_s}\right)^{0,7} \times \left(\frac{T_a}{298}\right)^{1,5} \quad (6-6)$$

6.1.1. For the test to be considered valid both the following conditions must be met:

- (a) f_a shall be within the range $0,93 \leq f_a \leq 1,07$ except as permitted by points 6.1.2 and 6.1.4;

▼ B

- (b) The temperature of intake air shall be maintained to 298 ± 5 K (25 ± 5 °C), measured upstream of any engine component, except as permitted by points 6.1.3 and 6.1.4, and as required by points 6.1.5 and 6.1.6.
- 6.1.2. Where the altitude of the laboratory in which the engine is being tested exceeds 600 m, with the agreement of the manufacturer f_a may exceed 1,07 on the condition that p_s shall not be less than 80 kPa.
- 6.1.3. Where the power of the engine being tested is greater than 560 kW, with the agreement of the manufacturer the maximum value of intake air temperature may exceed 303 K (30 °C) on the condition that it shall not exceed 308 K (35 °C).
- 6.1.4. Where the altitude of the laboratory in which the engine is being tested exceeds 300 m and the power of the engine being tested is greater than 560 kW, with the agreement of the manufacturer f_a may exceed 1,07 on the condition that p_s shall not be less than 80 kPa and the maximum value of intake air temperature may exceed 303 K (30 °C) on the condition that it shall not exceed 308 K (35 °C).
- 6.1.5. In the case of an engine family of category NRS less than 19 kW exclusively consisting of engine types to be used in snow throwers, the temperature of the intake air shall be maintained between 273 K and 268 K (0 °C and -5 °C).
- 6.1.6. For engines of category SMB the temperature of the intake air shall be maintained to 263 ± 5 K (-10 ± 5 °C), except as permitted by point 6.1.6.1.
- 6.1.6.1. For engines of category SMB fitted with electronically controlled fuel injection that adjusts the fuel flow to the intake air temperature, at the choice of the manufacturer the temperature of the intake air may alternatively be maintained to 298 ± 5 K (25 ± 5 °C).
- 6.1.7. It is allowed to use:
- (a) an atmospheric pressure meter whose output is used as the atmospheric pressure for an entire test facility that has more than one dynamometer test cell, as long as the equipment for handling intake air maintains ambient pressure, where the engine is tested, within ± 1 kPa of the shared atmospheric pressure;
- (b) A humidity measurement device to measure the humidity of intake air for an entire test facility that has more than one dynamometer test cell, as long as the equipment for handling intake air maintains dew point, where the engine is tested, within $\pm 0,5$ K of the shared humidity measurement.
- 6.2. Engines with charge-air cooling

▼ M2

A charge-air cooling system with a total intake-air capacity that represents production engines' in-use installation shall be used. Any laboratory charge-air cooling system shall be designed to minimize accumulation of condensate. Any accumulated condensate

▼ M2

shall be drained and all drains shall be completely closed before emission testing. The drains shall be kept closed during the emission test. Coolant conditions shall be maintained as follows:

- (a) a coolant temperature of at least 293 K (20 °C) shall be maintained at the inlet to the charge-air cooler throughout testing;
- (b) at the rated speed and full load, the coolant flow rate shall be set to achieve an air temperature within ± 5 K (± 5 °C) of the value designed by the manufacturer after the charge-air cooler's outlet. The air- outlet temperature shall be measured at the location specified by the manufacturer. This coolant flow rate set point shall be used throughout testing;
- (c) if the engine manufacturer specifies pressure-drop limits across the charge-air cooling system, it shall be ensured that the pressure drop across the charge-air cooling system at engine conditions specified by the manufacturer is within the manufacturer's specified limit(s). The pressure drop shall be measured at the manufacturer's specified locations.

▼ B

When the MTS defined in point 5.2.5.1 is being used in place of rated speed to run the test cycle then this speed may be used in place of rated speed when setting the charge air temperature.

The objective is to produce emission results that are representative of in-use operation. If good engineering judgment indicates that the specifications in this section would result in unrepresentative testing (such as overcooling of the intake air), more sophisticated set points and controls of charge-air pressure drop, coolant temperature, and flow rate may be used to achieve more representative results.

6.3. Engine power

▼ M2

6.3.1. Basis for emission measurement

The basis of specific emissions measurement is uncorrected net power as defined in Article 3(25) of Regulation (EU) 2016/1628.

▼ B

6.3.2. Auxiliaries to be fitted

During the test, the auxiliaries necessary for the engine operation shall be installed on the test bench according to the requirements of Appendix 2.

Where the necessary auxiliaries cannot be fitted for the test, the power they absorb shall be determined and subtracted from the measured engine power.

6.3.3. Auxiliaries to be removed

Certain auxiliaries whose definition is linked with the operation of the non-road mobile machinery and which may be mounted on the engine shall be removed for the test.

▼ B

Where auxiliaries cannot be removed, the power they absorb in the unloaded condition may be determined and added to the measured engine power (see note g in Appendix 2). If this value is greater than 3 % of the maximum power at the test speed it may be verified by the technical service. ► **M2** The power absorbed by auxiliaries shall be used to adjust the set values and to calculate the work produced by the engine over the test cycle in accordance with point 7.7.1.3 or point 7.7.2.3(b). ◀

▼ M2

6.3.4. Determination of auxiliary power

Where applicable as per point 6.3.2 and 6.3.3, the values of auxiliary power and the measurement/calculation method for determining auxiliary power shall be submitted by the engine manufacturer for the whole operating area of the applicable test cycles, and approved by the approval authority.

▼ B

6.3.5. Engine cycle work

The calculation of reference and actual cycle work (see point 7.8.3.4) shall be based upon engine power in accordance with point 6.3.1. In this case, P_f and P_r of equation (6-7) are zero, and P equals P_m .

If auxiliaries/equipment are installed in accordance with points 6.3.2 and/or 6.3.3, the power absorbed by them shall be used to correct each instantaneous cycle power value $P_{m,i}$, by means of equation (6-8):

$$P_i = P_{m,i} - P_{f,i} + P_{r,i} \quad (6-7)$$

$$P_{AUX} = P_{r,i} - P_{f,i} \quad (6-8)$$

Where:

$P_{m,i}$ is the measured engine power, kW

$P_{f,i}$ is the power absorbed by auxiliaries/equipment to be fitted for the test but that were not installed, kW

$P_{r,i}$ is the power absorbed by auxiliaries/equipment to be removed for the test but that were installed, kW.

6.4. Engine intake air

6.4.1. Introduction

The intake-air system installed on the engine or one that represents a typical in-use configuration shall be used. This includes the charge-air cooling and exhaust gas recirculation (EGR).

6.4.2. Intake air pressure restriction

An engine air intake system or a test laboratory system shall be used presenting an intake air pressure restriction within ± 300 Pa of the maximum value specified by the manufacturer for a clean air cleaner at the rated speed and full load. Where this is not possible due to the design of the test laboratory air supply system a pressure restriction not exceeding the value specified by the manufacturer for a dirty filter shall be permitted subject to prior approval of the technical service. The static differential pressure of the pressure restriction shall be measured at the location and at the speed and torque set points specified by the manufacturer. If the manufacturer does not specify a location, this pressure shall be measured upstream of any turbocharger or exhaust gas recirculation (EGR) connection to the intake air system.

▼B

When the MTS defined in point 5.2.5.1 is being used in place of rated speed to run the test cycle then this speed may be used in place of rated speed when setting the intake air pressure restriction.

6.5. Engine exhaust system

The exhaust system installed with the engine or one that represents a typical in-use configuration shall be used. The exhaust system shall conform to the requirements for exhaust emissions sampling, as set out in point 9.3. An engine exhaust system or a test laboratory system shall be used presenting a static exhaust gas back-pressure within 80 to 100 % of the maximum exhaust gas pressure restriction at the rated speed and full load. The exhaust gas pressure restriction may be set using a valve. If the maximum exhaust gas pressure restriction is 5 kPa or less, the set point shall not be more than 1,0 kPa from the maximum. When the MTS defined in point 5.2.5.1 is being used in place of rated speed to run the test cycle then this speed may be used in place of rated speed when setting the exhaust gas pressure restriction.

6.6. Engine with exhaust after-treatment system

If the engine is equipped with an exhaust after-treatment system that is not mounted directly on the engine, the exhaust pipe shall have the same diameter as found in-use for at least four pipe diameters upstream of the expansion section containing the after-treatment device. The distance from the exhaust manifold flange or turbocharger outlet to the exhaust after-treatment system shall be the same as in the non-road mobile machinery configuration or within the distance specifications of the manufacturer. Where specified by the manufacturer the pipe shall be insulated to achieve an after-treatment inlet temperature within the specification of the manufacturer. Where other installation requirements are specified by the manufacturer these shall also be respected for the test configuration. The exhaust gas back-pressure or pressure restriction shall be set according to point 6.5. For exhaust after-treatment devices with variable exhaust gas pressure restriction, the maximum exhaust gas pressure restriction used in point 6.5 is defined at the after-treatment condition (degreening/ageing and regeneration/loading level) specified by the manufacturer. The after-treatment container may be removed during dummy tests and during engine mapping, and replaced with an equivalent container having an inactive catalyst support.

The emissions measured on the test cycle shall be representative of the emissions in the field. In the case of an engine equipped with an exhaust after-treatment system that requires the consumption of a reagent, the reagent used for all tests shall be declared by the manufacturer.

For engines of category NRE, NRG, IWP, IWA, RLR, NRS, NRSh, SMB, and ATS equipped with exhaust after-treatment systems that are regenerated on an infrequent (periodic) basis, as described in point 6.6.2, emission results shall be adjusted to account for regeneration events. In this case, the average emission depends on the frequency of the regeneration event in

▼B

terms of fraction of tests during which the regeneration occurs. After-treatment systems with a regeneration process that occurs either in a sustained manner or at least once over the applicable transient (NRTC or LSI-NRTC) test cycle or RMC ('continuous regeneration') in accordance with point 6.6.1 do not require a special test procedure.

6.6.1. Continuous regeneration

For an exhaust after-treatment system based on a continuous regeneration process the emissions shall be measured on an after-treatment system that has been stabilized so as to result in repeatable emissions behaviour. The regeneration process shall occur at least once during the hot-start NRTC, LSI-NRTC or NRSC test, and the manufacturer shall declare the normal conditions under which regeneration occurs (soot load, temperature, exhaust gas back-pressure, etc.). In order to demonstrate that the regeneration process is continuous, at least three hot-start runs of the NRTC, LSI-NRTC or NRSC shall be conducted. In case of hot-start NRTC, the engine shall be warmed up in accordance with point 7.8.2.1, the engine be soaked according to point 7.4.2.1(b) and the first hot-start NRTC.

The subsequent hot-start NRTC shall be started after soaking according with point 7.4.2.1(b). During the tests, exhaust gas temperatures and pressures shall be recorded (temperature before and after the exhaust after-treatment system, exhaust gas back-pressure, etc.). The exhaust after-treatment system is considered to be satisfactory if the conditions declared by the manufacturer occur during the test within a sufficient time and the emission results do not scatter by more than $\pm 25\%$ from the mean value or 0,005 g/kWh, whichever is greater.

6.6.2. Infrequent regeneration

This provision only applies to engines equipped with an exhaust after-treatment system that is regenerated on an infrequent basis, typically occurring in less than 100 hours of normal engine operation. For those engines, either additive or multiplicative factors shall be determined for upward and downward adjustment as referred to in point 6.6.2.4 ('adjustment factor').

Testing and development of adjustment factors is only required for one applicable transient (NRTC or LSI-NRTC) test cycle or RMC. The factors that have been developed may be applied to results from the other applicable test cycles including discrete-mode NRSC.

In case that no suitable adjustment factors are available from testing using transient (NRTC or LSI-NRTC) test cycle or RMC then adjustment factors shall be established using an applicable discrete-mode NRSC test. Factors developed using a discrete-mode NRSC test shall only be applied to discrete-mode NRSC.

It shall not be required to conduct testing and develop adjustment factors on both RMC and discrete-mode NRSC.

▼ B

- 6.6.2.1. Requirement for establishing adjustment factors using NRTC, LSI-NRTC or RMC

The emissions shall be measured on at least three hot-start runs of the NRTC, LSI-NRTC or RMC, one with and two without a regeneration event on a stabilized exhaust after-treatment system. The regeneration process shall occur at least once during the NRTC, LSI-NRTC or RMC with a regeneration event. If regeneration takes longer than one NRTC, LSI-NRTC or RMC, consecutive NRTC, LSI-NRTC or RMC shall be run and emissions continued to be measured without shutting the engine off until regeneration is completed and the average of the tests shall be calculated. If regeneration is completed during any test, the test shall be continued over its entire length.

An appropriate adjustment factor shall be determined for the entire applicable cycle by means of equations (6-10) to (6-13).

- 6.6.2.2. Requirement for establishing adjustment factors using discrete-mode NRSC testing

Starting with a stabilized exhaust after-treatment system the emissions shall be measured on at least three runs of each test mode of the applicable discrete-mode NRSC on which the conditions for regeneration can be met, one with and two without a regeneration event. The measurement of PM shall be conducted using the multiple filter method described in point 7.8.1.2(c). If regeneration has started but is not complete at the end of the sampling period for a specific test mode extend the sampling period shall be extended until regeneration is complete. Where there are multiple runs for the same mode an average result shall be calculated. The process shall be repeated for each test mode.

An appropriate adjustment factor shall be determined by means of equations (6-10) to (6-13) for those modes of the applicable cycle for which regeneration occurs.

- 6.6.2.3. General procedure for developing infrequent regeneration adjustment factors (IRAFs)

The manufacturer shall declare the normal parameter conditions under which the regeneration process occurs (soot load, temperature, exhaust gas back-pressure, etc.). The manufacturer shall also provide the frequency of the regeneration event in terms of number of tests during which the regeneration occurs. **► M2** The exact procedure to determine this frequency shall be agreed by the approval authority based upon good engineering judgement. ◀

For a regeneration test, the manufacturer shall provide an exhaust after-treatment system that has been loaded. Regeneration shall not occur during this engine conditioning phase. As an option, the manufacturer may run consecutive tests of the applicable cycle until the exhaust after-treatment system is loaded. Emissions measurement is not required on all tests.

Average emissions between regeneration phases shall be determined from the arithmetic mean of several approximately equidistant tests of the applicable cycle. As a minimum, at least one applicable cycle as close as possible prior to a regeneration test and one applicable cycle immediately after a regeneration test shall be conducted.

▼ B

During the regeneration test, all the data needed to detect regeneration shall be recorded (CO or NO_x emissions, temperature before and after the exhaust after-treatment system, exhaust gas back-pressure, etc.). During the regeneration process, the applicable emission limits may be exceeded. The test procedure is schematically shown in Figure 6.1.

▼ M2

Figure 6.1

Scheme of infrequent regeneration with n number of measurements and n_r number of measurements during regeneration

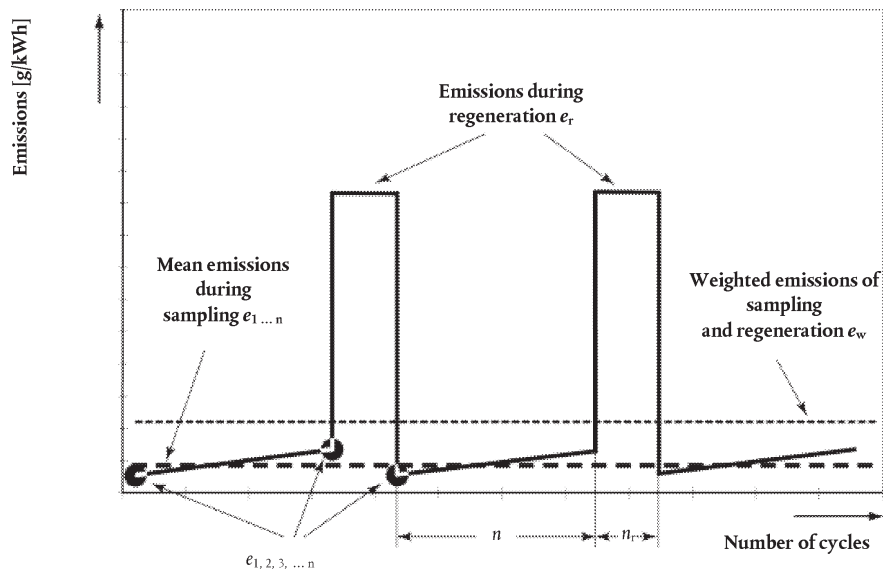
▼ B

The average specific emission rate related to the test runs conducted according to points 6.6.2.1 or 6.6.2.2 [g/kWh or #/kWh] shall be weighted by means of equation (6-9) (see Figure 6.1):

▼ M2

$$\bar{e}_w = \frac{n \cdot \bar{e} + n_r \cdot \bar{e}_r}{n + n_r} \quad (6-9)$$

Where:

n is the number of tests in which regeneration does not occur,

n_r is the number of tests in which regeneration occurs (minimum one test),

\bar{e} is the average specific emission from a test in which the regeneration does not occur [g/kWh or #/kWh]

\bar{e}_r is the average specific emission from a test in which the regeneration occurs [g/kWh or #/kWh]

▼ B

At the choice of the manufacturer and based on upon good engineering judgment, the regeneration adjustment factor k_r , expressing the average emission rate, may be calculated either multiplicative or additive for all gaseous pollutants, and, where there is an applicable limit, for PM and PN, by means of equations (6-10) to (6-13):

▼ B

Multiplicative

▼ M2

$$k_{ru,m} = \frac{\bar{e}_w}{\bar{e}} \quad (\text{upward adjustment factor}) \quad (6-10)$$

$$k_{rd,m} = \frac{\bar{e}_w}{\bar{e}_r} \quad (\text{downward adjustment factor}) \quad (6-11)$$

▼ B

Additive

▼ M2

$$k_{ru,a} = \bar{e}_w - \bar{e} \quad (\text{upward adjustment factor}) \quad (6-12)$$

$$k_{rd,a} = \bar{e}_w - \bar{e}_r \quad (\text{downward adjustment factor}) \quad (6-13)$$

▼ B

6.6.2.4. Application of adjustment factors

Upward adjustment factors are multiplied with or added to measured emission rates for all tests in which the regeneration does not occur. Downward adjustment factors are multiplied with or added to measured emission rates for all tests in which the regeneration occurs. The occurrence of the regeneration shall be identified in a manner that is readily apparent during all testing. Where no regeneration is identified, the upward adjustment factor shall be applied.

With reference to Annex VII and Appendix 5 of Annex VII on brake specific emission calculations, the regeneration adjustment factor:

- (a) When established for an entire weighted cycle, shall be applied to the results of the applicable weighted NRTC, LSI-NRTC and NRSC;
- (b) When established specifically for the individual modes of the applicable discrete-mode NRSC, shall be applied to the results of those modes of the applicable discrete-mode NRSC for which regeneration occurs prior to calculating the cycle weighted emission result. In this case the multiple filter method shall be used for PM measurement;
- (c) May be extended to other members of the same engine family;
- (d) May be extended to other engine families within the same engine after-treatment system family, as defined in Annex IX to Implementing Regulation (EU) 2017/656, with the prior approval of the approval authority based on technical evidence to be supplied by the manufacturer that the emissions are similar.

The following options shall apply:

- (a) A manufacturer may elect to omit adjustment factors for one or more of its engine families (or configurations) because the effect of the regeneration is small, or because it is not practical to identify when regenerations occur. In these cases, no adjustment factor shall be used, and the manufacturer is liable for compliance with the emission limits for all tests, without regard to whether a regeneration occurs;

▼ M2

- (b) Upon request by the manufacturer, the approval authority may account for regeneration events differently than pursuant to point (a). However, this option only applies to events that

▼ M2

occur extremely infrequently, and which cannot be practically addressed using the adjustment factors described in point 6.6.2.3.

▼ B

6.7. Cooling system

An engine cooling system with sufficient capacity to maintain the engine, with its intake-air, oil, coolant, block and head temperatures, at normal operating temperatures prescribed by the manufacturer shall be used. Laboratory auxiliary coolers and fans may be used.

6.8. Lubricating oil

The lubricating oil shall be specified by the manufacturer and be representative of lubricating oil available in the market; the specifications of the lubricating oil used for the test shall be recorded and presented with the results of the test.

6.9. Specification of the reference fuel

The reference fuels to be used for the test are specified in Annex IX.

The fuel temperature shall be in accordance with the manufacturer's recommendations. The fuel temperature shall be measured at the inlet to the fuel injection pump or as specified by the manufacturer, and the location of measurement recorded.

6.10. Crankcase emissions

This section shall apply to engines of category NRE, NRG, IWP, IWA, RLR, NRS, NRSh, SMB, & ATS complying with Stage V emission limits set out in Annex II to Regulation (EU) 2016/1628.

Crankcase emissions that are discharged directly into the ambient atmosphere shall be added to the exhaust emissions (either physically or mathematically) during all emission testing.

Manufacturers taking advantage of this exception shall install the engines so that all crankcase emission can be routed into the emissions sampling system. For the purpose of this point, crankcase emissions that are routed into the exhaust gas upstream of exhaust after-treatment system during all operation are not considered to be discharged directly into the ambient atmosphere.

Open crankcase emissions shall be routed into the exhaust system for emission measurement, as follows:

- (a) The tubing materials shall be smooth-walled, electrically conductive, and not reactive with crankcase emissions. Tube lengths shall be minimized as far as possible;
- (b) The number of bends in the laboratory crankcase tubing shall be minimized, and the radius of any unavoidable bend shall be maximized;
- (c) The laboratory crankcase exhaust tubing shall meet the engine manufacturer's specifications for crankcase back-pressure;
- (d) The crankcase exhaust tubing shall connect into the raw exhaust gas downstream of any exhaust after-treatment system, downstream of any installed exhaust emissions restriction, and sufficiently upstream of any sample probes to ensure complete mixing with the engine's exhaust system

▼B

before sampling. The crankcase exhaust tube shall extend into the free stream of exhaust system to avoid boundary-layer effects and to promote mixing. The crankcase exhaust tube's outlet may orient in any direction relative to the raw exhaust gas flow.

7. Test procedures

7.1. Introduction

This chapter describes the determination of brake specific emissions of gaseous and particulate pollutants on engines to be tested. The test engine shall be the parent engine configuration for the engine family as specified Annex IX to Implementing Regulation (EU) 2017/656.

A laboratory emission test consists of measuring emissions and other parameters for the test cycles specified in Annex XVII. The following aspects are treated:

- (a) The laboratory configurations for measuring the emissions (point 7.2);
- (b) The pre-test and post-test verification procedures (point 7.3);
- (c) The test cycles (point 7.4);
- (d) The general test sequence (point 7.5);
- (e) The engine mapping (point 7.6);
- (f) The test cycle generation (point 7.7);
- (g) The specific test cycle running procedure (point 7.8).

7.2. Principle of emission measurement

To measure the brake-specific emissions, the engine shall be operated over the test cycles defined in point 7.4, as applicable. The measurement of brake-specific emissions requires the determination of the mass of pollutants in the exhaust emissions (i.e. HC, CO, NO_x and PM), the number of particulates in the exhaust emissions (i.e. PN), the mass of CO₂ in the exhaust emissions, and the corresponding engine work.

7.2.1. Mass of constituent

The total mass of each constituent shall be determined over the applicable test cycle by using the following methods:

7.2.1.1. Continuous sampling

In continuous sampling, the constituent's concentration is measured continuously from raw or diluted exhaust gas. This concentration is multiplied by the continuous (raw or diluted) exhaust gas flow rate at the emission sampling location to determine the constituent's flow rate. The constituent's emission is continuously summed over the test interval. This sum is the total mass of the emitted constituent.

▼ **B**

7.2.1.2. Batch sampling

In batch sampling, a sample of raw or diluted exhaust gas is continuously extracted and stored for later measurement. The extracted sample shall be proportional to the raw or diluted exhaust gas flow rate. Examples of batch sampling are collecting diluted gaseous emissions in a bag and collecting PM on a filter. In principal the method of emission calculation is done as follows: the batch sampled concentrations are multiplied by the total mass or mass flow (raw or dilute) from which it was extracted during the test cycle. This product is the total mass or mass flow of the emitted constituent. To calculate the PM concentration, the PM deposited onto a filter from proportionally extracted exhaust gas shall be divided by the amount of filtered exhaust gas.

7.2.1.3. Combined sampling

Any combination of continuous and batch sampling is permitted (e.g. PM with batch sampling and gaseous emissions with continuous sampling).

Figure 6.2 illustrates the two aspects of the test procedures for measuring emissions: the equipment with the sampling lines in raw and diluted exhaust gas and the operations requested to calculate the pollutant emissions in steady-state and transient test cycles.

Figure 6.2

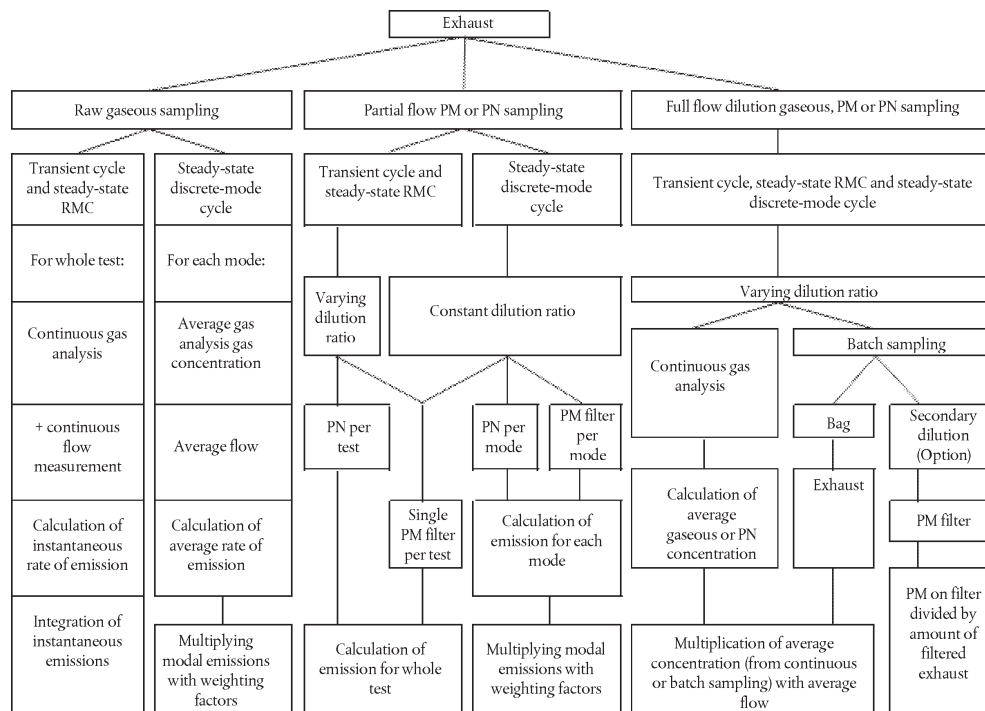
Test procedures for emission measurement

Note on Figure 6.2: The term ‘Partial flow PM sampling’ includes the partial flow dilution to extract only raw exhaust gas with constant or varying dilution ratio.

▼ B

7.2.2. Work determination

The work shall be determined over the test cycle by synchronously multiplying speed and brake torque to calculate instantaneous values for engine brake power. Engine brake power shall be integrated over the test cycle to determine total work.

7.3. Verification and calibration

7.3.1. Pre-test procedures

▼ M2

7.3.1.1. General requirements for preconditioning the sampling system and the engine

▼ B

To achieve stable conditions, the sampling system and the engine shall be preconditioned before starting a test sequence as specified in this point.

The intent of engine preconditioning is to achieve the representativeness of emissions and emission controls over the duty cycle and to reduce bias in order to meet stable conditions for the following emission test.

Emissions may be measured during preconditioning cycles, as long as a predefined number of preconditioning cycles are performed and the measurement system has been started according to the requirements of point 7.3.1.4. The amount of preconditioning shall be identified by the engine manufacturer before starting to precondition. Preconditioning shall be performed as follows, noting that the specific cycles for preconditioning are the same ones that apply for emission testing.

▼ M2

Engines fitted with an after-treatment system may be operated prior to cycle-specific preconditioning set out in points 7.3.1.1.1 to 7.3.1.1.4, so that the after-treatment system is regenerated and, where applicable, the soot load in the particulate after-treatment system is re-established.

▼ B

7.3.1.1.1. Preconditioning for cold-start run of NRTC

The engine shall be preconditioned by running at least one hot-start NRTC. Immediately after completing each preconditioning cycle, the engine shall be shut down and the engine-off hot-soak period shall be completed. Immediately after completing the last preconditioning cycle, the engine shall be shut down and the engine cool down described in point 7.3.1.2 shall be started.

7.3.1.1.2. Preconditioning for hot-start run of NRTC or for LSI-NRTC

This point describes the pre-conditioning that shall be applied when it is intended to sample emissions from the hot-start NRTC without running the cold-start run of the NRTC ('cold-start NRTC'), or for the LSI-NRTC. The engine shall be preconditioned by running at least one hot-start NRTC or LSI-NRTC as applicable. Immediately after completing each preconditioning cycle, the engine shall be shut down, and then the next cycle shall be started

▼ B

as soon as practical. It is recommended that the next preconditioning cycle shall be started within 60 seconds after completing the last preconditioning cycle. Where applicable, following the last pre-conditioning cycle the appropriate hot-soak (hot-start NRTC) or cool-down (LSI-NRTC) period shall apply before the engine is started for the emissions test. Where no hot-soak or cool down period applies it is recommended that the emissions test shall be started within 60 seconds after completing the last pre-conditioning cycle.

7.3.1.1.3. Preconditioning for discrete-mode NRSC

For engine categories other than NRS and NRSh the engine shall be warmed-up and run until engine temperatures (cooling water and lube oil) have been stabilized on 50 % speed and 50 % torque for any discrete-mode NRSC test cycle other than type D2, E2, or G, or nominal engine speed and 50 % torque for any discrete-mode NRSC test cycle D2, E2 or G. The 50 % speed shall be calculated in accordance with point 5.2.5.1 in the case of an engine where MTS is used for the generation of test speeds, and calculated in accordance with point 7.7.1.3 in all other cases. 50 % torque is defined as 50 % of the maximum available torque at this speed. The emissions test shall be started without stopping the engine.

For engine categories NRS and NRSh the engine shall be warmed up according to the recommendation of the manufacturer and good engineering judgment. Before emission sampling can start, the engine shall be running on mode 1 of the appropriate test cycle until engine temperatures have been stabilized. The emissions test shall be started without stopping the engine.

7.3.1.1.4. Preconditioning for RMC

The engine manufacturer shall select one of the following preconditioning sequences (a) or (b). The engine shall be preconditioned according to the chosen sequence.

(a) The engine shall be preconditioned by running at least the second half of the RMC, based on the number of test modes. The engine shall not be shut down between cycles. Immediately after completing each preconditioning cycle, the next cycle (including the emission test) shall be started as soon as practical. Where possible, it is recommended that the next cycle be started within 60 seconds after completing the last preconditioning cycle.

(b) The engine shall be warmed-up and run until engine temperatures (cooling water and lube oil) have been stabilized on 50 % speed and 50 % torque for any RMC test cycle other than type D2, E2, or G, or nominal engine speed and 50 % torque for any RMC test cycle D2, E2 or G. The 50 % speed shall be calculated in accordance with point 5.2.5.1 in the case of an engine where MTS is used for the generation of test speeds, and be calculated in accordance with point 7.7.1.3 in all other cases. 50 % torque is defined as 50 % of the maximum available torque at this speed.

▼ M2

▼ M2

7.3.1.2. Engine cool-down (NRTC)

A natural or forced cool-down procedure may be applied. For forced cool-down, good engineering judgment shall be used to set up systems to send cooling air across the engine, to send cool oil through the engine lubrication system, to remove heat from the coolant through the engine cooling system, and to remove heat from an exhaust after-treatment system. In the case of a forced after-treatment cool down, cooling air shall not be applied until the exhaust after-treatment system has cooled below its catalytic activation temperature. Any cooling procedure that results in unrepresentative emissions is not permitted.

7.3.1.3. Verification of HC contamination

If there is any presumption of an essential HC contamination of the exhaust gas measuring system, the contamination with HC may be checked with zero gas and the hang-up may then be corrected. If the amount of contamination of the measuring system and the background HC system has to be checked, it shall be conducted within 8 hours of starting each test-cycle. The values shall be recorded for later correction. Before this check, the leak check has to be performed and the FID analyzer has to be calibrated.

7.3.1.4. Preparation of measurement equipment for sampling

The following steps shall be taken before emission sampling begins:

- (a) Leak checks shall be performed within 8 hours prior to emission sampling in accordance with point 8.1.8.7;
- (b) For batch sampling, clean storage media shall be connected, such as evacuated bags or tare-weighed filters;
- (c) All measurement instruments shall be started in accordance with the instrument manufacturer's instructions and good engineering judgment;
- (d) Dilution systems, sample pumps, cooling fans, and the data-collection system shall be started;
- (e) The sample flow rates shall be adjusted to desired levels, using bypass flow, if desired;
- (f) Heat exchangers in the sampling system shall be pre-heated or pre-cooled to within their operating temperature ranges for a test;
- (g) Heated or cooled components such as sample lines, filters, chillers, and pumps shall be allowed to stabilize at their operating temperatures;
- (h) Exhaust gas dilution system flow shall be switched on at least 10 minutes before a test sequence;
- (i) Calibration of gas analyzers and zeroing of continuous analyzers shall be carried out in accordance with the procedure of point 7.3.1.5;
- (j) Any electronic integrating devices shall be zeroed or re-zeroed, before the start of any test interval.

7.3.1.5. Calibration of gas analyzers

Appropriate gas analyzer ranges shall be selected. Emission analyzers with automatic or manual range switching are allowed.

▼ M2

During a test using transient (NRTC or LSI-NRTC) test cycles or RMC and during a sampling period of a gaseous emission at the end of each mode for discrete-mode NRSC testing, the range of the emission analyzers shall not be switched. Also the gains of an analyzer's analogue operational amplifier(s) shall not be switched during a test cycle.

All continuous analyzers shall be zeroed and spanned using internationally-traceable gases that meet the specifications of point 9.5.1. FID analyzers shall be spanned on a carbon number basis of one (C₁).

7.3.1.6. PM filter preconditioning and tare weighing

The procedures for PM filter preconditioning and tare weighing shall be performed in accordance with point 8.2.3.

▼ B

7.3.2. Post-test procedures

The following steps shall be taken after emission sampling is complete:

7.3.2.1. Verification of proportional sampling

For any proportional batch sample, such as a bag sample or PM sample, it shall be verified that proportional sampling was maintained according to point 8.2.1. For the single filter method and the discrete steady-state test cycle, effective PM weighting factor shall be calculated. Any sample that does not fulfil the requirements of point 8.2.1 shall be voided.

7.3.2.2. Post-test PM conditioning and weighing

Used PM sample filters shall be placed into covered or sealed containers or the filter holders shall be closed, in order to protect the sample filters against ambient contamination. Thus protected, the loaded filters have to be returned to the PM-filter conditioning chamber or room. Then the PM sample filters shall be conditioned and weighted accordingly to point 8.2.4 (PM filter post-conditioning and total weighing procedures).

7.3.2.3. Analysis of gaseous batch sampling

As soon as practical, the following shall be performed:

- (a) All batch gas analyzers shall be zeroed and spanned no later than 30 minutes after the test cycle is complete or during the soak period if practical to check if gaseous analyzers are still stable;
- (b) Any conventional gaseous batch samples shall be analyzed no later than 30 minutes after the hot-start NRTC is complete or during the soak period;
- (c) The background samples shall be analyzed no later than 60 minutes after the hot-start NRTC is complete.

7.3.2.4. Drift verification

After quantifying exhaust gas, drift shall be verified as follows:

- (a) For batch and continuous gas analyzers, the mean analyzer value shall be recorded after stabilizing a zero gas to the analyzer. Stabilization may include time to purge the analyzer of any sample gas, plus any additional time to account for analyzer response;

▼ B

- (b) The mean analyzer value shall be recorded after stabilizing the span gas to the analyzer. Stabilization may include time to purge the analyzer of any sample gas, plus any additional time to account for analyzer response;
- (c) These data shall be used to validate and correct for drift as described in point 8.2.2.

▼ M2

7.4. Test cycles

The EU type-approval test shall be conducted using the appropriate NRSC and, where applicable, NRTC or LSI-NRTC, specified in Article 18 of Regulation (EU) 2016/1628 and Annex IV thereto. The technical specifications and characteristics of the NRSC, NRTC and LSI-NRTC are laid down in Annex XVII of this Regulation and the method for determination of the torque, power and speed settings for these test cycles set out in section 5.2.

▼ B

7.4.1. Steady-state test cycles

Non-road steady-state test cycles (NRSC) are specified in Appendices 1 and 2 of Annex XVII as a list of discrete-modes NRSC (operating points), where each operating point has one value of speed and one value of torque. A NRSC shall be measured with a warmed up and running engine according to manufacturer's specification. At the choice of the manufacturer, a NRSC may be run as a discrete-mode NRSC or a RMC, as explained in points 7.4.1.1 and 7.4.1.2. It shall not be required to conduct an emission test according to both points 7.4.1.1 and 7.4.1.2.

7.4.1.1. Discrete-mode NRSC

The discrete-mode NRSC are hot running cycles where emissions shall be started to be measured after the engine is started, warmed up and running as specified in point 7.8.1.2. Each cycle consists of a number of speed and load modes (with the respective weighing factor for each mode) which cover the typical operating range of the specified engine category.

7.4.1.2. Ramped modal NRSC

The RMC are hot running cycles where emissions shall be started to be measured after the engine is started, warmed up and running as specified in point 7.8.2.1. The engine shall be continuously controlled by the test bed control unit during the RMC. The gaseous and particulate emissions shall be measured and sampled continuously during the RMC in the same way as in a transient (NRTC or LSI-NRTC) test cycles.

An RMC is intended to provide a method for performing a steady-state test in a pseudo-transient manner. Each RMC consists of a series of steady state modes with a linear transition between them. The relative total time at each mode and its preceding transition match the weighting of the discrete-mode NRSC. The change in engine speed and load from one mode to the next one has to be linearly controlled in a time of 20 ± 1 seconds. The mode change time is part of the new mode (including the first mode). In some cases modes are not run in the same order as the discrete-mode NRSC or are split to prevent extreme changes in temperature.

▼ B

7.4.2. Transient (NRTC and LSI-NRTC) test cycles

The non-road transient cycle for engines of category NRE (NRTC) and the non-road transient cycle for large spark ignition engines of category NRS (LSI-NRTC) are each specified in Appendix 3 of Annex XVII as a second-by-second sequence of normalized speed and torque values. In order to perform the test in an engine test cell, the normalized values shall be converted to their equivalent reference values for the individual engine to be tested, based on specific speed and torque values identified in the engine-mapping curve. The conversion is referred to as denormalization, and the resulting test cycle is the reference NRTC or LSI-NRTC test cycle of the engine to be tested (see point 7.7.2).

7.4.2.1. Test sequence for NRTC

A graphical display of the normalized NRTC dynamometer schedule is shown in Figure 6.3.

Figure 6.3

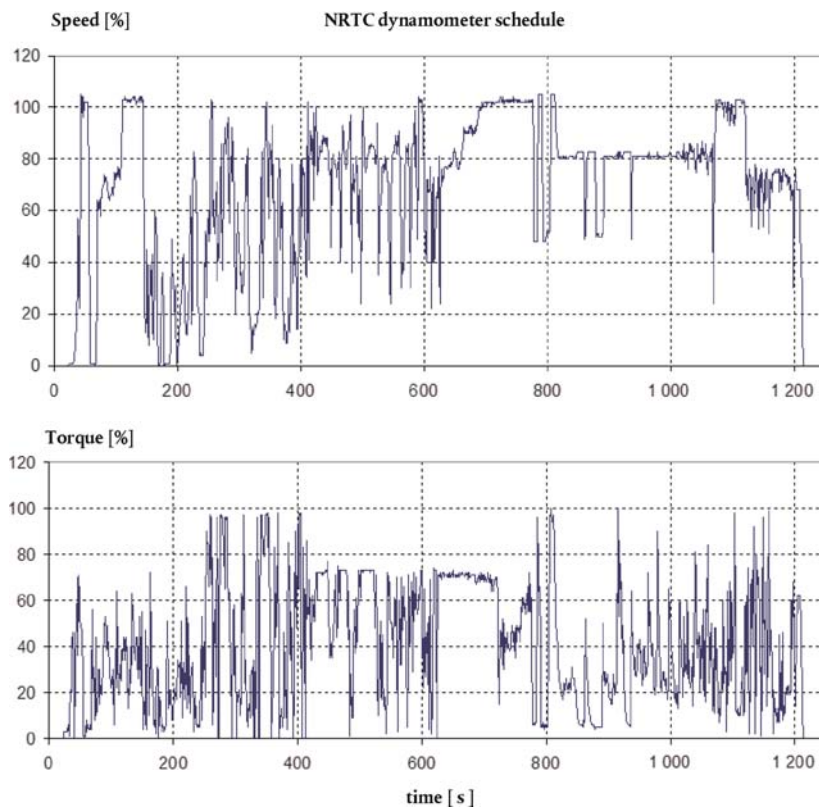
NRTC normalized dynamometer schedule

The NRTC shall be run twice after completion of pre-conditioning (see point 7.3.1.1.1) in accordance with the following procedure:

▼ M2

- (a) the cold start run shall commence after either the engine and exhaust after-treatment systems have cooled down to room temperature after natural engine cool down, or after forced

▼ M2

cool down, and the engine, coolant and oil temperatures, exhaust after-treatment systems and all engine control devices are stabilized between 293 K and 303 K (20 °C and 30 °C). The measurement of the emissions for this run shall be started with the start of the cold engine;

▼ B

- (b) the hot soak period shall commence immediately upon completion of the cold start phase. The engine shall be shut-down and conditioned for the hot-start run by soaking it for 20 minutes ± 1 minute;

▼ M2

- (c) the hot-start run shall commence immediately after the soak period with the cranking of the engine. The gaseous analyzers shall be switched on at least 10 seconds before the end of the soak period to avoid switching signal peaks. The measurement of emissions for this run shall be started in parallel with the cranking of the engine.

Brake specific emissions expressed in (g/kWh), or number per kilowatt-hour (#/kWh) for PN, shall be determined by using the procedures set out in this section for both the cold start run and hot-start run of the test cycle. Composite weighted emissions shall be computed by weighting the cold-start run results by 10 % and the hot-start run results by 90 % as detailed in Annex VII.

▼ B

7.4.2.2. Test sequence for LSI-NRTC

The LSI-NRTC shall be run once as a hot-start run after completion of pre-conditioning (see point 7.3.1.1.2) in accordance with the following procedure:

- (a) the engine shall be started and operated for the first 180 seconds of the duty cycle, then operated at idle without load for 30 seconds. Emissions shall not be measured during this warm-up sequence.
- (b) At the end of the 30-second idling period, emissions measurement shall be started and the engine be operated over the entire duty cycle from the beginning (time 0 sec).

Brake specific emissions expressed in (g/kWh) shall be determined by using the procedures of Annex VII.

If the engine was already operating before the test, use good engineering judgment to let the engine cool down enough so measured emissions will accurately represent those from an engine starting at room temperature. For example, if an engine starting at room temperature warms up enough in three minutes to start closed-loop operation and achieve full catalyst activity, then minimal engine cooling is necessary before starting the next test.

▼B

With the prior agreement of the technical service, the engine warm-up procedure may include up to 15 minutes of operation over the duty cycle.

7.5. General test sequence

To measure engine emissions the following steps have to be performed:

- (a) The engine test speeds and test loads have to be defined for the engine to be tested by measuring the max torque (for constant-speed engines) or max torque curve (for variable-speed engines) as function of the engine speed;
- (b) Normalized test cycles have to be denormalized with the torque (for constant-speed engines) or speeds and torques (for variable-speed engines) found in the previous point 7.5(a);
- (c) The engine, equipment, and measurement instruments shall be prepared for the following emission test or test series (cold-start run and hot-start run) in advance;
- (d) Pre-test procedures shall be performed to verify proper operation of certain equipment and analyzers. All analysers have to be calibrated. All pre-test data shall be recorded;
- (e) The engine shall be started (NRTC) or kept running (steady-state cycles and LSI-NRTC) at the beginning of the test cycle and the sampling systems shall be started at the same time;
- (f) Emissions and other required parameters shall be measured or recorded during sampling time (for NRTC, LSI-NRTC and RMC throughout the whole test cycle);
- (g) Post-test procedures shall be performed to verify proper operation of certain equipment and analyzers;
- (h) PM filter(s) shall be pre-conditioned, weighed (empty weight), loaded, re-conditioned, again weighed (loaded weight) and then samples shall be evaluated in accordance with the pre-test (point 7.3.1.6) and post-test (point 7.3.2.2) procedures;

▼M2**▼B**

- (i) Emission test results shall be evaluated.

Figure 6.4 gives an overview about the procedures needed to conduct NRMM test cycles with measuring exhaust engine emissions.

▼ M2

Figure 6.4
Test sequence

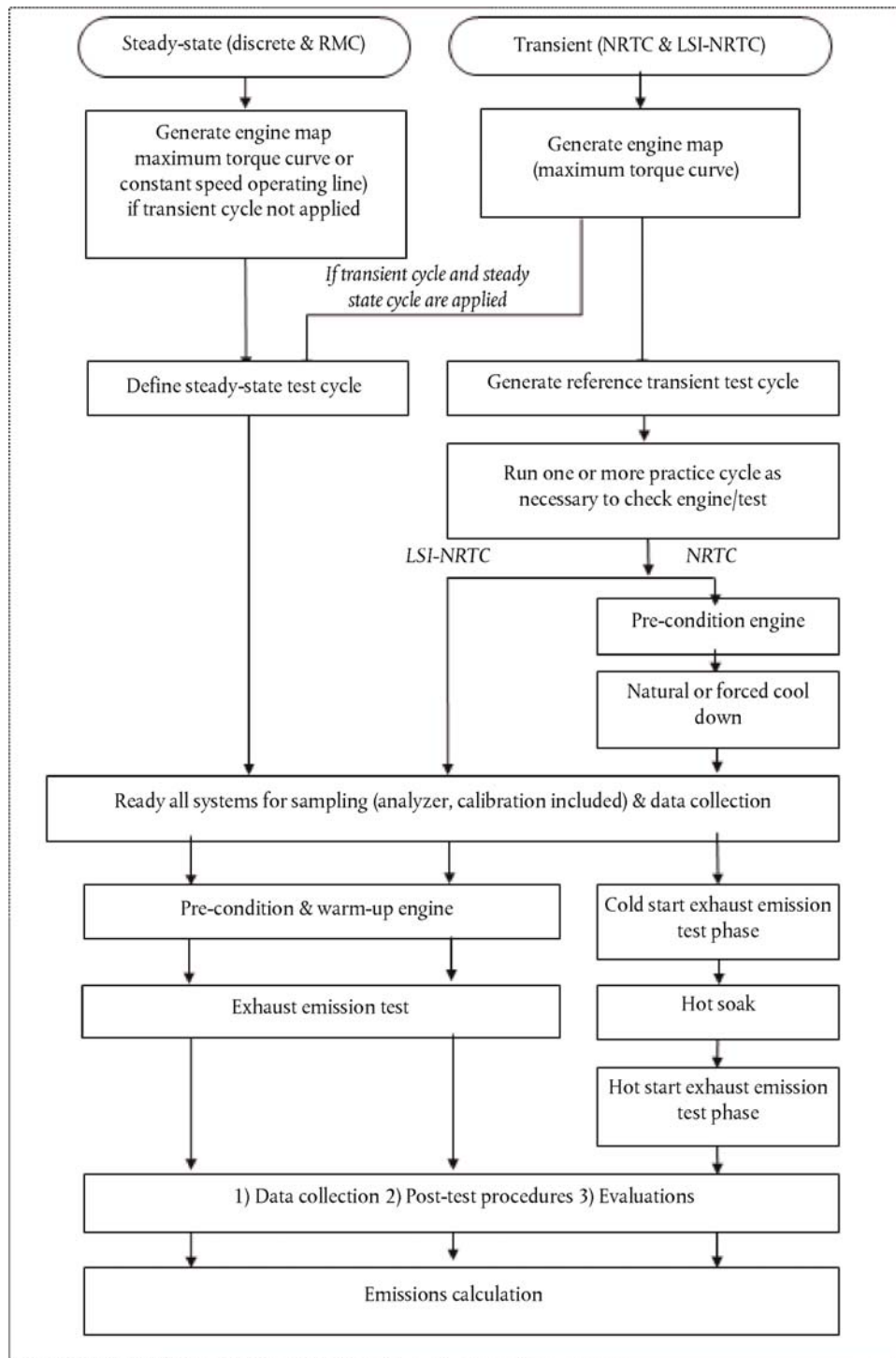

▼ B

7.5.1. Engine starting, and restarting

7.5.1.1. Engine start

The engine shall be started:

- (a) As recommended in the end-users' instructions using a production starter motor or air-start system and either an adequately charged battery, a suitable power supply or a suitable compressed air source; or
- (b) By using the dynamometer to crank the engine until it starts. Typically operate the engine within $\pm 25\%$ of its typical in-use cranking speed or start the engine by linearly increasing the dynamometer speed from zero to 100 min^{-1} below low idle speed but only until the engine starts.

Cranking shall be stopped within 1 s of starting the engine. If the engine does not start after 15 s of cranking, cranking shall be stopped and the reason for the failure to start determined, unless the end-users' instructions or the service-repair manual describes a longer cranking time as normal.

7.5.1.2. Engine stalling

▼ M2

- (a) If the engine stalls anywhere during the cold start run of the NRTC, the entire test shall be voided;
- (b) If the engine stalls anywhere during the hot-start run of the NRTC, only this run shall be voided. The engine shall be soaked in accordance with point 7.8.3, and the hot-start run repeated. In this case, the cold-start run does not need to be repeated;

▼ B

- (c) If the engine stalls anywhere during the LSI-NRTC, the test shall be voided.

- (d) If the engine stalls anywhere during the NRSC (discrete or ramped), the test shall be voided and be repeated beginning with the engine warm-up procedure. In the case of PM measurement utilizing the multi-filter method (one sampling filter for each operating mode), the test shall be continued by stabilizing the engine at the previous mode for engine temperature conditioning and then initiating measurement with the mode where the engine stalled.

7.5.1.3 Engine operation

The 'operator' may be a person (i.e., manual), or a governor (i.e., automatic) that mechanically or electronically signals an input that demands engine output. Input may be from an accelerator pedal or signal, a throttle-control lever or signal, a fuel lever or signal, a speed lever or signal, or a governor set point or signal.

▼ B

7.6. Engine mapping

Before starting the engine mapping, the engine shall be warmed up and towards the end of the warm up it shall be operated for at least 10 minutes at maximum power or according to the recommendation of the manufacturer and good engineering judgement in order to stabilize the engine coolant and lube oil temperatures. When the engine is stabilized, the engine mapping shall be performed.

Where the manufacturer intends to use the torque signal broadcast by the electronic control unit, of engines so equipped, during the conduct of in-service monitoring tests according to Delegated Regulation (EU) 2017/655 on monitoring of emissions of in-service engines, the verification set out in Appendix 3 shall additionally be performed during the engine mapping.

Except constant-speed engines, engine mapping shall be performed with fully open fuel lever or governor using discrete speeds in ascending order. The minimum and maximum mapping speeds are defined as follows:

Minimum mapping speed = warm idle speed

Maximum mapping speed = $n_{hi} \times 1,02$ or speed where max torque drops off to zero, whichever is smaller.

Where:

n_{hi} is the high speed, ► **M2** as defined in Article 1(12) ◀.

If the highest speed is unsafe or unrepresentative (e.g., for ungoverned engines), good engineering judgement shall be used to map up to the maximum safe speed or the maximum representative speed.

7.6.1. Engine mapping for variable-speed NRSC

In the case of engine mapping for a variable-speed NRSC (only for engines which have not to run the NRTC or LSI-NRTC cycle), good engineering judgment shall be used to select a sufficient number of evenly spaced set-points. At each set-point, speed shall be stabilized and torque allowed to stabilize at least for 15 seconds. The mean speed and torque shall be recorded at each set-point. It is recommended that the mean speed and torque are calculated using the recorded data from the last 4 to 6 seconds. Linear interpolation shall be used to determine the NRSC test speeds and torques if needed. When engines are additionally required to run an NRTC or LSI-NRTC, the NRTC engine mapping curve shall be used to determine steady-state test speeds and torques.

At the choice of the manufacturer the engine mapping may alternatively be conducted according to the procedure in point 7.6.2.

▼B

7.6.2. Engine mapping for NRTC and LSI-NRTC

The engine mapping shall be performed according to the following procedure:

- (a) The engine shall be unloaded and operated at idle speed;
 - (i) For engines with a low-speed governor, the operator demand shall be set to the minimum, the dynamometer or another loading device shall be used to target a torque of zero on the engine's primary output shaft and the engine shall be allowed to govern the speed. This warm idle speed shall be measured;
 - (ii) For engines without a low-speed governor, the dynamometer shall be set to target a torque of zero on the engine's primary output shaft, and the operator demand shall be set to control the speed to the manufacturer-declared lowest engine speed possible with minimum load (also known as manufacturer-declared warm idle speed);
 - (iii) The manufacturer declared idle torque may be used for all variable-speed engines (with or without a low-speed governor), if a nonzero idle torque is representative of in-use operation;
- (b) Operator demand shall be set to maximum and engine speed shall be controlled to between warm idle and 95 % of its warm idle speed. For engines with reference duty cycles, which lowest speed is greater than warm idle speed, the mapping may be started at between the lowest reference speed and 95 % of the lowest reference speed;
- (c) The engine speed shall be increased at an average rate of $8 \pm 1 \text{ min}^{-1}/\text{s}$ or the engine shall be mapped by using a continuous sweep of speed at a constant rate such that it takes 4 to 6 min to sweep from minimum to maximum mapping speed. The mapping speed range shall be started between warm idle and 95 % of warm idle and ended at the highest speed above maximum power at which less than 70 % of maximum power occurs. If this highest speed is unsafe or unrepresentative (e.g., for ungoverned engines), good engineering judgment shall be used to map up to the maximum safe speed or the maximum representative speed. Engine speed and torque points shall be recorded at a sample rate of at least 1 Hz;
- (d) If a manufacturer believes that the above mapping techniques are unsafe or unrepresentative for any given engine, alternate mapping techniques may be used. These alternate techniques shall satisfy the intent of the specified mapping procedures to determine the maximum available torque at all engine speeds achieved during the test cycles. Deviations from the mapping techniques specified in this section for reasons of safety or

▼B

representativeness shall be approved by the approval authority along with the justification for their use. In no case, however, the torque curve shall be run by descending engine speeds for governed or turbocharged engines;

- (e) An engine need not be mapped before each and every test cycle. An engine shall be remapped if:
- (i) an unreasonable amount of time has transpired since the last map, as determined by good engineering judgment; or
 - (ii) physical changes or recalibrations have been made to the engine which potentially affect engine performance; or
 - (iii) the atmospheric pressure near the engine's air inlet is not within ± 5 kPa of the value recorded at the time of the last engine map.

7.6.3. Engine mapping for constant-speed NRSC

The engine may be operated with a production constant-speed governor or a constant-speed governor maybe simulated by controlling engine speed with an operator demand control system. Either isochronous or speed-droop governor operation shall be used, as appropriate.

7.6.3.1. Rated power check for engines to be tested on cycles D2 or E2

The following check shall be conducted:

- (a) With the governor or simulated governor controlling speed using operator demand the engine shall be operated at the rated speed and the rated power for as long as required to achieve stable operation;
- (b) The torque shall be increased until the engine is unable to maintain the governed speed. The power at this point shall be recorded. Before this check is performed the method to safely determine when this point has been reached shall be agreed between the manufacturer and the technical service conducting the check, depending upon the characteristics of the governor. ► **M2** The power recorded shall not exceed the rated power as defined in Article 3(27) of Regulation (EU) 2016/1628 by more than 12,5 %. If this value is exceeded the manufacturer shall revise the declared rated power. ◀

If the specific engine being tested is unable to perform this check due to risk of damage to the engine or dynamometer the manufacturer shall present to the approval authority robust evidence that maximum power does not exceed the rated power by more than 12,5 %.

▼B

- 7.6.3.2. Mapping procedure for constant-speed NRSC
- (a) With the governor or simulated governor controlling speed using operator demand, the engine shall be operated at no-load governed speed (at high speed, not low idle) for at least 15 seconds, unless the specific engine is unable to perform this task;
 - (b) The dynamometer shall be used to increase torque at a constant rate. The map shall be conducted such that it takes no less than 2 min to sweep from no-load governed speed to the torque corresponding to rated power for engines to be tested on cycle D2 or E2 or to maximum torque in the case of other constant-speed test cycles. During the engine mapping actual speed and torque shall be recorded with at least 1 Hz;
 - (c) In case of a constant-speed engine with a governor that can be reset to alternative speeds, the engine shall be tested at each applicable constant-speed.

For constant-speed engines good engineering judgment shall be used in agreement with the approval authority to apply other methods to record torque and power at the defined operating speed(s).

For engines tested on cycles other than D2 or E2, when both measured and declared values are available for the maximum torque, the declared value may be used instead of the measured value if it is between 95 and 100 % of the measured value.

7.7. Test cycle generation

7.7.1. Generation of NRSC

This point shall be used to generate the engine speeds and loads over which the engine shall be operated during steady-state tests with discrete-mode NRSC or RMC.

7.7.1.1. Generation of NRSC test speeds for engines tested with both NRSC and either NRTC or LSI-NRTC.

For engines that are tested with either NRTC or LSI-NRTC in addition to a NRSC, the MTS specified in point 5.2.5.1 shall be used as the 100 % speed for both transient and steady state tests.

The MTS shall be used in place of rated speed when determining intermediate speed in accordance with point 5.2.5.4.

The idle speed shall be determined in accordance with point 5.2.5.5.

7.7.1.2. Generation of NRSC test speeds for engines only tested with NRSC

For engines that are not tested with a transient (NRTC or LSI-NRTC) test cycle, the rated speed specified in point 5.2.5.3 shall be used as the 100 % speed.

▼B

The rated speed shall be used to determine the intermediate speed in accordance with point 5.2.5.4. If the NRSC specifies additional speeds as a percentage they shall be calculated as a percentage of the rated speed.

The idle speed shall be determined in accordance with point 5.2.5.5.

With prior approval of the technical service, MTS may be used instead of rated speed for the generation of test speeds in this point.

7.7.1.3. Generation of NRSC load for each test mode

The per cent load for each test mode of the chosen test cycle shall be taken from the appropriate NRSC Table of Appendix 1 or 2 of Annex XVII. Depending upon the test cycle, the per cent load in these Tables is expressed as either power or torque in accordance with point 5.2.6 and in the footnotes for each Table.

The 100 % value at a given test speed shall be the measured or declared value taken from the mapping curve generated in accordance with point 7.6.1, point 7.6.2 or point 7.6.3 respectively, expressed as power (kW).

The engine setting for each test mode shall be calculated by means of equation (6-14):

$$S = \left((P_{\max} + P_{\text{AUX}}) \cdot \frac{L}{100} \right) - P_{\text{AUX}} \quad (6-14)$$

Where:

S is the dynamometer setting in kW

P_{\max} is the maximum observed or declared power at the test speed under the test conditions (specified by the manufacturer) in kW

P_{AUX} is the declared total power absorbed by auxiliaries as defined in equation (6-8) (see point 6.3.5) at the specified test speed in kW

L is per cent torque

A warm minimum torque that is representative of in-use operation may be declared and used for any load point that would otherwise fall below this value if the engine type will not normally operate below this minimum torque, for example because it will be connected to a non-road mobile machinery that does not operate below a certain minimum torque.

In the case of cycles E2 and D2 the manufacturer shall declare the rated power and these shall be used as 100 % power when generating the test cycle.

▼B

7.7.2. Generation of NRTC & LSI-NRTC speed and load for each test point (denormalization)

This point shall be used to generate the corresponding engine speeds and loads over which the engine shall be operated during NRTC or LSI-NRTC tests. Appendix 3 of Annex XVII defines applicable test cycles in a normalized format. A normalized test cycle consists of a sequence of paired values for speed and torque %.

Normalized values of speed and torque shall be transformed using the following conventions:

- (a) The normalized speed shall be transformed into a sequence of reference speeds, n_{ref} , in accordance with point 7.7.2.2;
- (b) The normalized torque is expressed as a percentage of the mapped torque from the curve generated according to point 7.6.2 at the corresponding reference speed. These normalized values shall be transformed into a sequence of reference torques, T_{ref} , according to point 7.7.2.3;
- (c) The reference speed and reference torque values expressed in coherent units are multiplied to calculate the reference power values.

7.7.2.1. Reserved

7.7.2.2. Denormalization of engine speed

The engine speed shall be denormalized using by means of equation (6-15):

$$n_{ref} = \frac{\%speed \times (MTS - n_{idle})}{100} + n_{idle} \quad (6-15)$$

Where:

n_{ref} is the reference speed

MTS is the maximum test speed

n_{idle} is the idle speed

$\%speed$ is the value of NRTC or LSI-NRTC normalized speed taken from Appendix 3 of Annex XVII.

7.7.2.3 Denormalization of engine torque

The torque values in the engine dynamometer schedule of Appendix 3 of Annex XVII. are normalized to the maximum torque at the respective speed. The torque values of the reference cycle shall be denormalized, using the mapping curve determined according to point 7.6.2, by means of equation (6-16):

$$T_{ref} = \frac{\%torque \cdot max.torque}{100} \quad (6-16)$$

for the respective reference speed as determined in point 7.7.2.2

Where:

T_{ref} is the reference torque for the respective reference speed

▼ M2

max.torque is the maximum torque for the respective test speed taken from the engine mapping performed in accordance with point 7.6.2 adjusted where necessary in accordance with point 7.7.2.3(b)

▼ B

%torque is the value of NRTC or LSI-NRTC normalized torque taken from Appendix 3 of Annex XVII

(a) Declared minimum torque

A minimum torque that is representative of in-use operation may be declared. For example, if the engine is typically connected to a non-road mobile machinery that does not operate below a certain minimum torque, this torque may be declared and used for any load point that would otherwise fall below this value.

(b) Adjustment of engine torque due to auxiliaries fitted for the emissions test

Where auxiliaries are fitted in accordance with Appendix 2 there shall be no adjustment to the maximum torque for the respective test speed taken from the engine mapping performed according to point 7.6.2.

Where, according to points 6.3.2 or 6.3.3 necessary auxiliaries that should have been fitted for the test are not installed, or auxiliaries that should have been removed for the test are installed, the value of T_{\max} shall be adjusted by means of equation (6-17).

$$T_{\max} = T_{\text{map}} - T_{\text{AUX}} \quad (6-17)$$

with:

$$T_{\text{AUX}} = T_r - T_f \quad (6-18)$$

where:

T_{map} is the unadjusted maximum torque for the respective test speed taken from the engine mapping performed in accordance with point 7.6.2

T_f is the torque required to drive auxiliaries that should have been fitted but were not installed for the test

T_r is the torque required to drive auxiliaries that should have been removed for the test but were installed for the test

7.7.2.4. Example of denormalization procedure

As an example, the following test point shall be denormalized:

% speed = 43 %

% torque = 82 %

Given the following values:

$MTS = 2\,200 \text{ min}^{-1}$

▼ B

$$n_{\text{idle}} = 600 \text{ min}^{-1}$$

results in

$$n_{\text{ref}} = \frac{43 \cdot (2\,200 - 600)}{100} + 600 = 1\,288 \text{ min}^{-1}$$

With the maximum torque of 700 Nm observed from the mapping curve at 1 288 min⁻¹

$$T_{\text{ref}} = \frac{82 \times 700}{100} = 574 \text{ Nm}$$

- 7.8. Specific test cycle running procedure
- 7.8.1. Emission test sequence for discrete-mode NRSC
- 7.8.1.1. Engine warming-up for steady state discrete-mode NRSC

Pre-test procedure according to point 7.3.1 shall be performed, including analyzer calibration. The engine shall be warmed-up using the pre-conditioning sequence in point 7.3.1.1.3. Immediately from this engine conditioning point, the test cycle measurement starts.
- 7.8.1.2. Performing discrete-mode NRSC
 - (a) The test shall be performed in ascending order of mode numbers as set out for the test cycle (see Appendix 1 of Annex XVII);

▼ M2

- (b) Each mode has a mode length of at least 10 minutes. In each mode the engine shall be stabilised for at least 5 minutes. Gaseous emissions, and, where applicable, PN, shall be sampled for 1 to 3 minutes at the end of each mode and PM emissions shall be sampled in accordance with point (c);

Notwithstanding the previous paragraph, when either testing spark ignition engines using cycles G1, G2 or G3 or when conducting measurements in accordance with Annex V of this Regulation each mode has a mode length of at least 3 minutes. In this case gaseous emissions, and, where applicable, PN, shall be sampled for at least the last 2 minutes of each mode and PM emissions shall be sampled in accordance with point (c). The mode length and sampling time may be extended to improve accuracy;

The mode length shall be recorded and reported.

▼ B

- (c) ► **M2** For PM emissions, the PM sampling may be done either with the single filter method or with the multiple filter method. Since the results of the methods may differ slightly, the method used shall be declared with the results; ◀

For the single filter method the modal weighting factors specified in the test cycle procedure and the actual exhaust gas flow shall be taken into account during sampling by adjusting sample flow rate and/or sampling time, accordingly. It is required that the effective weighing factor of the PM sampling is within ± 0,005 of the weighing factor of the given mode;

Sampling shall be conducted as late as possible within each mode. For the single filter method, the completion of PM sampling shall be coincident within ± 5 s with the completion of the gaseous emission measurement. The sampling time per

▼ B

mode shall be at least 20 s for the single filter method and at least 60 s for the multi-filter method. For systems without bypass capability, the sampling time per mode shall be at least 60 s for single and multiple filter methods;

- (d) The engine speed and load, intake air temperature, fuel flow and where applicable air or exhaust gas flow shall be measured for each mode at the same time interval which is used for the measurement of the gaseous concentrations;

Any additional data required for calculation shall be recorded.

- (e) If the engine stalls or the emission sampling is interrupted at any time after emission sampling begins for a discrete-mode NRSC and the single filter method, the test shall be voided and be repeated beginning with the engine warm-up procedure. In the case of PM measurement utilizing the multi-filter method (one sampling filter for each operating mode), the test shall be continued by stabilizing the engine at the previous mode for engine temperature conditioning and then initiating measurement with the mode where the engine stalled;

- (f) Post-test procedures according to point 7.3.2 shall be performed.

7.8.1.3. Validation criteria

During each mode of the given steady-state test cycle after the initial transition period, the measured speed shall not deviate from the reference speed for more than $\pm 1\%$ of rated speed or $\pm 3 \text{ min}^{-1}$, whichever is greater except for idle which shall be within the tolerances declared by the manufacturer. The measured torque shall not deviate from the reference torque for more than $\pm 2\%$ of the maximum torque at the test speed.

7.8.2. Emission test sequence for RMC

7.8.2.1. Engine warming-up

Pre-test procedure according to point 7.3.1 shall be performed, including analyzer calibration. The engine shall be warmed-up using the pre-conditioning sequence in point 7.3.1.1.4. Immediately after this engine conditioning procedure, if the engine speed and torque are not already set for the first mode of the test they shall be changed in a linear ramp of $20 \pm 1 \text{ s}$ to the first mode of the test. In between 5 to 10 s after the end of the ramp, the test cycle measurement shall start.

7.8.2.2. Performing an RMC

The test shall be performed in the order of mode numbers as set out for the test cycle (see Appendix 2 of Annex XVII) Where there is no RMC available for the specified NRSC the discrete-mode NRSC procedure set out in point 7.8.1 shall be followed.

▼B

The engine shall be operated for the prescribed time in each mode. The transition from one mode to the next shall be done linearly in $20 \text{ s} \pm 1 \text{ s}$ following the tolerances prescribed in point 7.8.2.4.

For RMC, reference speed and torque values shall be generated at a minimum frequency of 1 Hz and this sequence of points shall be used to run the cycle. During the transition between modes, the denormalized reference speed and torque values shall be linearly ramped between modes to generate reference points. The normalized reference torque values shall not be linearly ramped between modes and then denormalized. If the speed and torque ramp runs through a point above the engine's torque curve, it shall be continued to command the reference torques and it shall be allowed for the operator demand to go to maximum.

Over the whole RMC (during each mode and including the ramps between the modes), the concentration of each gaseous pollutant shall be measured and where there is an applicable limit the PM and PN be sampled. The gaseous pollutants may be measured raw or diluted and be recorded continuously; if diluted, they can also be sampled into a sampling bag. The particulate sample shall be diluted with conditioned and clean air. One sample over the complete test procedure shall be taken, and, in the case of PM collected on a single PM sampling filter.

For calculation of the brake specific emissions, the actual cycle work shall be calculated by integrating actual engine power over the complete cycle.

7.8.2.3. Emission test sequence

- (a) Execution of the RMC, sampling exhaust gas, recording data, and integrating measured values shall be started simultaneously;
- (b) Speed and torque shall be controlled to the first mode in the test cycle;
- (c) If the engine stalls anywhere during the RMC execution, the test shall be voided. The engine shall be pre-conditioned and the test repeated;
- (d) At the end of the RMC, sampling shall be continued, except for PM sampling, operating all systems to allow system response time to elapse. Then all sampling and recording shall be stopped, including the recording of background samples. Finally, any integrating devices shall be stopped and the end of the test cycle shall be indicated in the recorded data;
- (e) Post-test procedures according to point 7.3.2 shall be performed.

7.8.2.4. Validation criteria

RMC tests shall be validated using the regression analysis as described in points 7.8.3.3 and 7.8.3.5. The allowed RMC tolerances are given in the following Table 6.1. Note that the RMC tolerances are different from the NRTC tolerances of Table 6.2. ►M2 When conducting testing of engines of reference power greater than 560 kW the regression line tolerances of Table 6.2 and the point deletion of Table 6.3 may be used. ◀



Table 6.1

RMC Regression line tolerances

	Speed	Torque	Power
Standard error of estimate (SEE) of y on x	maximum 1 % of rated speed	maximum 2 % of maximum engine torque	maximum 2 % of maximum engine power
Slope of the regression line, a_1	0,99 to 1,01	0,98 - 1,02	0,98 - 1,02
Coefficient of determination, r^2	minimum 0,990	minimum 0,950	minimum 0,950
y intercept of the regression line, a_0	± 1 % of rated speed	± 20 Nm or 2 % of maximum torque whichever is greater	± 4 kW or 2 % of maximum power whichever is greater

In case of running the RMC test not on a transient test bed, where the second by second speed and torque values are not available, the following validation criteria shall be used.

At each mode the requirements for the speed and torque tolerances are given in point 7.8.1.3. For the 20 s linear speed and linear torque transitions between the RMC steady-state test modes (point 7.4.1.2) the following tolerances for speed and load shall be applied for the ramp:

- (a) the speed shall be held linear within ± 2 % of rated speed,
- (b) the torque shall be held linear within ± 5 % of the maximum torque at rated speed.

7.8.3. Transient (NRTC and LSI-NRTC) test cycles

Reference speeds and torques commands shall be sequentially executed to perform the NRTC and LSI-NRTC. Speed and torque commands shall be issued at a frequency of at least 5 Hz. Because the reference test cycle is specified at 1 Hz, the in between speed and torque commands shall be linearly interpolated from the reference torque values generated from cycle generation.

Small denormalized speed values near warm idle speed may cause low-speed idle governors to activate and the engine torque to exceed the reference torque even though the operator demand is at a minimum. In such cases, it is recommended to control the dynamometer so it gives priority to follow the reference torque instead of the reference speed and let the engine govern the speed.

Under cold-start conditions engines may use an enhanced-idle device to quickly warm up the engine and the exhaust after-treatment system. Under these conditions, very low normalized speeds will generate reference speeds below this higher enhanced idle speed. In this case it is recommended controlling the dynamometer so it gives priority to follow the reference torque and let the engine govern the speed when the operator demand is at minimum.

▼B

During an emission test, reference speeds and torques and the feedback speeds and torques shall be recorded with a minimum frequency of 1 Hz, but preferably of 5 Hz or even 10 Hz. This larger recording frequency is important as it helps to minimize the biasing effect of the time lag between the reference and the measured feedback speed and torque values.

The reference and feedback speeds and torques may be recorded at lower frequencies (as low as 1 Hz), if the average values over the time interval between recorded values are recorded. The average values shall be calculated based on feedback values updated at a frequency of at least 5 Hz. These recorded values shall be used to calculate cycle-validation statistics and total work.

7.8.3.1. Performing an NRTC test

Pre-test procedures according to point 7.3.1 shall be performed, including pre-conditioning, cool-down and analyzer calibration.

Testing shall be started as follows:

The test sequence shall commence immediately after the engine has started from cooled down condition specified in point 7.3.1.2 in case of the cold-start NRTC or from hot soak condition in case of the hot-start NRTC. The sequence in point 7.4.2.1 shall be followed.

Data logging, sampling of exhaust gas and integrating measured values shall be initiated simultaneously at the start of the engine. The test cycle shall be initiated when the engine starts and shall be executed according to the schedule of Appendix 3 of Annex XVII.

At the end of the cycle, sampling shall be continued, operating all systems to allow system response time to elapse. Then all sampling and recording shall be stopped, including the recording of background samples. Finally, any integrating devices shall be stopped and the end of the test cycle shall be indicated in the recorded data.

Post-test procedures according to point 7.3.2 shall be performed.

7.8.3.2. Performing an LSI-NRTC test

Pre-test procedures according to point 7.3.1 shall be performed, including pre-conditioning and analyzer calibration.

Testing shall be started as follows:

The test shall commence according to the sequence given in point 7.4.2.2.

Data logging, sampling of exhaust gas and integrating measured values shall be initiated simultaneously with the start of the LSI-NRTC at the end of the 30-second idle period specified in point 7.4.2.2(b). The test cycle shall be executed according to the schedule of Appendix 3 of Annex XVII.

At the end of the cycle, sampling shall be continued, operating all systems to allow system response time to elapse. Then all sampling and recording shall be stopped, including the recording of background samples. Finally, any integrating devices shall be stopped and the end of the test cycle shall be indicated in the recorded data.

▼B

Post-test procedures according to point 7.3.2 shall be performed.

7.8.3.3. Cycle validation criteria for transient (NRTC and LSI-NRTC) test cycles

In order to check the validity of a test, the cycle-validation criteria in this point shall be applied to the reference and feedback values of speed, torque, power and overall work.

7.8.3.4. Calculation of cycle work

Before calculating the cycle work, any speed and torque values recorded during engine starting shall be omitted. Points with negative torque values have to be accounted for as zero work. The actual cycle work W_{act} (kWh) shall be calculated based on engine feedback speed and torque values. The reference cycle work W_{ref} (kWh) shall be calculated based on engine reference speed and torque values. The actual cycle work W_{act} is used for comparison to the reference cycle work W_{ref} and for calculating the brake specific emissions (see point 7.2).

W_{act} shall be between 85 % and 105 % of W_{ref} .

7.8.3.5. Validation statistics (see Appendix 2 of Annex VII)

Linear regression between the reference and the feedback values shall be calculated for speed, torque and power.

To minimize the biasing effect of the time lag between the reference and feedback cycle values, the entire engine speed and torque feedback signal sequence may be advanced or delayed in time with respect to the reference speed and torque sequence. If the feedback signals are shifted, both speed and torque shall be shifted by the same amount in the same direction.

The method of least squares shall be used, with the best-fit equation having the form set out in equation (6-19):

$$y = a_1x + a_0 \quad (6-19)$$

where:

y is the feedback value of speed (min^{-1}), torque (Nm), or power (kW)

a_1 is the slope of the regression line

x is the reference value of speed (min^{-1}), torque (Nm), or power (kW)

a_0 is the y intercept of the regression line.

The standard error of estimate (*SEE*) of y on x and the coefficient of determination (r^2) shall be calculated for each regression line in accordance with Appendix 3 of Annex VII.

It is recommended that this analysis be performed at 1 Hz. For a test to be considered valid, the criteria of Table 6.2 shall be met.

Table 6.2

Regression line tolerances

	Speed	Torque	Power
Standard error of estimate (<i>SEE</i>) of y on x	$\leq 5,0$ percent of maximum test speed	$\leq 10,0$ % of maximum mapped torque	$\leq 10,0$ % of maximum mapped power

▼ **B**

	Speed	Torque	Power
Slope of the regression line, a_1	0,95 to 1,03	0,83 - 1,03	0,89 - 1,03
Coefficient of determination, r^2	minimum 0,970	minimum 0,850	minimum 0,910
y intercept of the regression line, a_0	$\leq 10\%$ of idle	± 20 Nm or $\pm 2\%$ of maximum torque whichever is greater	± 4 kW or $\pm 2\%$ of maximum power whichever is greater

For regression purposes only, point deletions are permitted where noted in Table 6.3 before doing the regression calculation. However, those points shall not be deleted for the calculation of cycle work and emissions. An idle point is defined as a point having a normalized reference torque of 0 % and a normalized reference speed of 0 %. Point deletion may be applied to the whole or to any part of the cycle; points to which the point deletion is applied have to be specified.

▼ **M2**

Table 6.3

Permitted point deletions from regression analysis

Event	Conditions (n = engine speed, T = torque)	Permitted point deletions
Minimum operator demand (idle point)	$n_{\text{ref}} = n_{\text{idle}}$ and $T_{\text{ref}} = 0\%$ and $T_{\text{act}} > (T_{\text{ref}} - 0,02 T_{\text{maxmappedtorque}})$ and $T_{\text{act}} < (T_{\text{ref}} + 0,02 T_{\text{maxmappedtorque}})$	speed and power
Minimum operator demand	$n_{\text{act}} \leq 1,02 n_{\text{ref}}$ and $T_{\text{act}} > T_{\text{ref}}$ or $n_{\text{act}} > n_{\text{ref}}$ and $T_{\text{act}} \leq T_{\text{ref}}$ or $n_{\text{act}} > 1,02 n_{\text{ref}}$ and $T_{\text{ref}} < T_{\text{act}} \leq (T_{\text{ref}} + 0,02 T_{\text{maxmappedtorque}})$	power and either torque or speed
Maximum operator demand	$n_{\text{act}} < n_{\text{ref}}$ and $T_{\text{act}} \geq T_{\text{ref}}$ or $n_{\text{act}} \geq 0,98 n_{\text{ref}}$ and $T_{\text{act}} < T_{\text{ref}}$ or $n_{\text{act}} < 0,98 n_{\text{ref}}$ and $T_{\text{ref}} > T_{\text{act}} \geq (T_{\text{ref}} - 0,02 T_{\text{maxmappedtorque}})$	power and either torque or speed

Where:

n_{ref}	is the reference speed (see section 7.7.2.),
n_{idle}	is the idle speed,
n_{act}	is the actual (measured) speed,
T_{ref}	is the reference torque (see section 7.7.2.),
T_{act}	is the actual (measured) torque,
$T_{\text{maxmappedtorque}}$	is the highest value of torque on the full-load torque curve mapped in accordance with section 7.6.

▼B

8. Measurement procedures
- 8.1. Calibration and performance checks
- 8.1.1. Introduction

This point describes required calibrations and verifications of measurement systems. See point 9.4 for specifications that apply to individual instruments.

Calibrations or verifications shall be generally performed over the complete measurement chain.

If a calibration or verification for a portion of a measurement system is not specified, that portion of the system shall be calibrated and its performance verified at a frequency consistent with any recommendations from the measurement system manufacturer and consistent with good engineering judgment.

Internationally recognized-traceable standards shall be used to meet the tolerances specified for calibrations and verifications.

- 8.1.2. Summary of calibration and verification

Table 6.4 summarizes the calibrations and verifications described in section 8 and indicates when these have to be performed.

Table 6.4

Summary of Calibration and Verifications

Type of calibration or verification	Minimum frequency (°)
8.1.3: accuracy, repeatability and noise	Accuracy: Not required, but recommended for initial installation. Repeatability: Not required, but recommended for initial installation. Noise: Not required, but recommended for initial installation.
8.1.4: linearity verification	Speed: Upon initial installation, within 370 days before testing and after major maintenance. Torque: Upon initial installation, within 370 days before testing and after major maintenance. Intake air, dilution air and diluted exhaust gas flows and batch sample flow rates: Upon initial installation, within 370 days before testing and after major maintenance, unless flow is verified by propane check or by carbon or oxygen balance. Raw exhaust gas flow: Upon initial installation, within 185 days before testing and after major maintenance, unless flow is verified by propane check or by carbon or oxygen balance. Gas dividers: Upon initial installation, within 370 days before testing and after major maintenance. Gas analyzers (unless otherwise noted): Upon initial installation, within 35 days before testing and after major maintenance.



Type of calibration or verification	Minimum frequency (a)
	<p>FTIR analyser: Upon installation, within 370 days before testing and after major maintenance.</p> <p>PM balance: Upon initial installation, within 370 days before testing and after major maintenance.</p> <p>Stand-alone pressure and temperature: Upon initial installation, within 370 days before testing and after major maintenance.</p>
8.1.5: Continuous gas analyzer system response and updating-recording verification — for gas analyzers not continuously compensated for other gas species	Upon initial installation or after system modification that would affect response.
8.1.6: Continuous gas analyzer system response and updating-recording verification — for gas analyzers continuously compensated for other gas species	Upon initial installation or after system modification that would affect response.
8.1.7.1: torque	Upon initial installation and after major maintenance.
8.1.7.2: pressure, temperature, dew point	Upon initial installation and after major maintenance.
8.1.8.1: fuel flow	Upon initial installation and after major maintenance.
8.1.8.2: intake flow	Upon initial installation and after major maintenance.
8.1.8.3: exhaust gas flow	Upon initial installation and after major maintenance.
8.1.8.4: diluted exhaust gas flow (CVS and PFD)	Upon initial installation and after major maintenance.
8.1.8.5: CVS/PFD and batch sampler verification (b)	Upon initial installation, within 35 days before testing, and after major maintenance. (Propane check)
8.1.8.8: vacuum leak	Upon installation of the sampling system. Before each laboratory test according to point 7.1: within 8 hours before the start of the first test interval of each duty cycle sequence and after maintenance such as pre-filter changes.
8.1.9.1: CO ₂ NDIR H ₂ O interference	Upon initial installation and after major maintenance.
8.1.9.2: CO NDIR CO ₂ and H ₂ O interference	Upon initial installation and after major maintenance.
8.1.10.1: FID calibration HC FID optimization and HC FID verification	<p>Calibrate, optimize, and determine CH₄ response: upon initial installation and after major maintenance.</p> <p>Verify CH₄ response: upon initial installation, within 185 days before testing, and after major maintenance.</p>

▼ B

Type of calibration or verification	Minimum frequency ^(a)
8.1.10.2: raw exhaust gas FID O ₂ interference	For all FID analyzers: upon initial installation, and after major maintenance. For THC FID analyzers: upon initial installation, after major maintenance, and after FID optimization according to 8.1.10.1.
8.1.11.1: CLD CO ₂ and H ₂ O quench	Upon initial installation and after major maintenance.
8.1.11.3: NDUV HC and H ₂ O interference	Upon initial installation and after major maintenance.
▼ M2	
8.1.11.4: Sample dryer NO ₂ penetration (chiller)	Upon initial installation and after major maintenance.
▼ B	
8.1.11.5: NO ₂ -to-NO converter conversion	Upon initial installation, within 35 days before testing, and after major maintenance.
▼ M2	
8.1.12: Sample dryer verification	For thermal chillers: upon installation and after major maintenance. For osmotic membranes: upon installation, within 35 days of testing and after major maintenance.
▼ B	
8.1.13.1: PM balance and weighing	Independent verification: upon initial installation, within 370 days before testing, and after major maintenance. Zero, span, and reference sample verifications: within 12 hours of weighing, and after major maintenance.

^(a) Perform calibrations and verifications more frequently, according to measurement system manufacturer instructions and good engineering judgment.

^(b) The CVS verification is not required for systems that agree within $\pm 2\%$ based on a chemical balance of carbon or oxygen of the intake air, fuel, and diluted exhaust gas.

8.1.3. Verifications for accuracy, repeatability, and noise

The performance values for individual instruments specified in Table 6.8 are the basis for the determination of the accuracy, repeatability, and noise of an instrument.

It is not required to verify instrument accuracy, repeatability, or noise. However, it may be useful to consider these verifications to define a specification for a new instrument, to verify the performance of a new instrument upon delivery, or to troubleshoot an existing instrument.

8.1.4. Linearity verification

8.1.4.1. Scope and frequency

A linearity verification shall be performed on each measurement system listed in Table 6.5 at least as frequently as indicated in the Table, consistent with measurement system manufacturer recommendations and good engineering judgment. The intent of a linearity verification is to determine that a measurement system responds proportionally over the measurement range of interest. A linearity verification shall consist of introducing a series of at

▼B

least

10 reference values to a measurement system, unless otherwise specified. The measurement system quantifies each reference value. The measured values shall be collectively compared to the reference values by using a least squares linear regression and the linearity criteria specified in Table 6.5.

8.1.4.2. Performance requirements

If a measurement system does not meet the applicable linearity criteria in Table 6.5, the deficiency shall be corrected by re-calibrating, servicing, or replacing components as needed. The linearity verification shall be repeated after correcting the deficiency to ensure that the measurement system meets the linearity criteria.

8.1.4.3. Procedure

The following linearity verification protocol shall be used:

- (a) A measurement system shall be operated at its specified temperatures, pressures, and flows;
- (b) The instrument shall be zeroed as it would before an emission test by introducing a zero signal. For gas analyzers, a zero gas shall be used that meets the specifications of point 9.5.1 and it shall be introduced directly at the analyzer port;
- (c) The instrument shall be spanned as it would before an emission test by introducing a span signal. For gas analyzers, a span gas shall be used that meets the specifications of point 9.5.1 and it shall be introduced directly at the analyzer port;
- (d) After spanning the instrument, zero shall be checked with the same signal which has been used in paragraph (b) of this point. Based on the zero reading, good engineering judgment shall be used to determine whether or not to re-zero and or re-span the instrument before proceeding to the next step;
- (e) For all measured quantities manufacturer recommendations and good engineering judgment shall be used to select the reference values, y_{refi} , that cover the full range of values that are expected during emission testing, thus avoiding the need of extrapolation beyond these values. A zero reference signal shall be selected as one of the reference values of the linearity verification. For stand-alone pressure and temperature linearity verifications, at least three reference values shall be selected. For all other linearity verifications, at least ten reference values shall be selected;
- (f) Instrument manufacturer recommendations and good engineering judgment shall be used to select the order in which the series of reference values will be introduced;
- (g) Reference quantities shall be generated and introduced as described in point 8.1.4.4. For gas analyzers, gas concentrations known to be within the specifications of point 9.5.1 shall be used and they shall be introduced directly at the analyzer port;
- (h) Time for the instrument to stabilize while it measures the reference value shall be allowed;
- (i) At a recording frequency of at least the minimum frequency, as specified in Table 6.7, the reference value shall be measured for 30 s and the arithmetic mean of the recorded values, \bar{y}_i recorded;

▼ B

- (j) Steps in paragraphs (g) to (i) of this point shall be repeated until all reference quantities are measured;
- (k) The arithmetic means \bar{y}_i , and reference values, y_{refi} , shall be used to calculate least-squares linear regression parameters and statistical values to compare to the minimum performance criteria specified in Table 6.5. The calculations described in Appendix 3 of Annex VII shall be used.

8.1.4.4. Reference signals

This point describes recommended methods for generating reference values for the linearity-verification protocol in point 8.1.4.3. Reference values shall be used that simulate actual values, or an actual value shall be introduced and measured with a reference-measurement system. In the latter case, the reference value is the value reported by the reference-measurement system. Reference values and reference-measurement systems shall be internationally traceable.

For temperature measurement systems with sensors like thermocouples, RTDs, and thermistors, the linearity verification may be performed by removing the sensor from the system and using a simulator in its place. A simulator that is independently calibrated and cold junction compensated, as necessary shall be used. The internationally traceable simulator uncertainty scaled to temperature shall be less than 0,5 % of maximum operating temperature T_{max} . If this option is used, it is necessary to use sensors that the supplier states are accurate to better than 0,5 % of T_{max} compared to their standard calibration curve.

8.1.4.5. Measurement systems that require linearity verification

Table 6.5 indicates measurement systems that require linearity verifications. For this Table the following provisions shall apply:

- (a) a linearity verification shall be performed more frequently if the instrument manufacturer recommends it or based on good engineering judgment;
- (b) 'min' refers to the minimum reference value used during the linearity verification;

Note that this value may be zero or a negative value depending on the signal;

- (c) 'max' generally refers to the maximum reference value used during the linearity verification. For example for gas dividers, x_{max} is the undivided, undiluted, span gas concentration. The following are special cases where 'max' refers to a different value:
 - (i) For PM balance linearity verification, m_{max} refers to the typical mass of a PM filter;
 - (ii) For torque linearity verification, T_{max} refers to the manufacturer's specified engine torque peak value of the highest torque engine to be tested;
- (d) the specified ranges are inclusive. For example, a specified range of 0,98-1,02 for the slope a_1 means $0,98 \leq a_1 \leq 1,02$;

▼B

- (e) these linearity verifications are not required for systems that pass the flow-rate verification for diluted exhaust gas as described in point 8.1.8.5 for the propane check or for systems that agree within $\pm 2\%$ based on a chemical balance of carbon or oxygen of the intake air, fuel, and exhaust gas;
- (f) a_1 criteria for these quantities shall be met only if the absolute value of the quantity is required, as opposed to a signal that is only linearly proportional to the actual value;
- (g) stand-alone temperatures include engine temperatures and ambient conditions used to set or verify engine conditions; temperatures used to set or verify critical conditions in the test system; and temperatures used in emissions calculations:
 - (i) these temperature linearity checks are required. Air intake; after-treatment bed(s) (for engines tested with exhaust after-treatment systems on cycles with cold start criteria); dilution air for PM sampling (CVS, double dilution, and partial flow systems); PM sample; and chiller sample (for gaseous sampling systems that use chillers to dry samples);
 - (ii) these temperature linearity checks are only required if specified by the engine manufacturer. Fuel inlet; test cell charge air cooler air outlet (for engines tested with a test cell heat exchanger simulating a non-road mobile machinery charge air cooler); test cell charge air cooler coolant inlet (for engines tested with a test cell heat exchanger simulating a non-road mobile machinery charge air cooler); and oil in the sump/pan; coolant before the thermostat (for liquid cooled engines);
- (h) stand-alone pressures include engine pressures and ambient conditions used to set or verify engine conditions; pressures used to set or verify critical conditions in the test system; and pressures used in emissions calculations:
 - (i) required pressure linearity checks are: intake air pressure restriction; exhaust gas back-pressure; barometer; CVS inlet gage pressure (if measurement using CVS); chiller sample (for gaseous sampling systems that use chillers to dry samples);
 - (ii) pressure linearity checks that are required only if specified by the engine manufacturer: test cell charge air cooler and interconnecting pipe pressure drop (for turbo-charged engines tested with a test cell heat exchanger simulating a non-road mobile machinery charge air cooler) fuel inlet; and fuel outlet.



Table 6.5

Measurement systems that require linearity verifications

Measurement System	Quantity	Minimum verification frequency	Linearity Criteria			
			$ x_{min} \cdot (a_1 - 1) + a_0 $	α	SEE	r^2
Engine speed	n	Within 370 days before testing	$\leq 0,05 \% n_{max}$	0,98-1,02	$\leq 2 \% n_{max}$	$\geq 0,990$
Engine torque	T	Within 370 days before testing	$\leq 1 \% T_{max}$	0,98-1,02	$\leq 2 \% T_{max}$	$\geq 0,990$
Fuel flow rate	q_m	Within 370 days before testing	$\leq 1 \% q_{m, max}$	0,98-1,02	$\leq 2 \% q_{m, max}$	$\geq 0,990$
Intake-air flow rate (1)	q_V	Within 370 days before testing	$\leq 1 \% q_{V, max}$	0,98-1,02	$\leq 2 \% q_{V, max}$	$\geq 0,990$
Dilution air flow rate (1)	q_V	Within 370 days before testing	$\leq 1 \% q_{V, max}$	0,98-1,02	$\leq 2 \% q_{V, max}$	$\geq 0,990$
Diluted exhaust gas flow rate (1)	q_V	Within 370 days before testing	$\leq 1 \% q_{V, max}$	0,98-1,02	$\leq 2 \% q_{V, max}$	$\geq 0,990$
Raw exhaust gas flow rate (1)	q_V	Within 185 days before testing	$\leq 1 \% q_{V, max}$	0,98-1,02	$\leq 2 \% q_{V, max}$	$\geq 0,990$
Batch sampler flow rates (1)	q_V	Within 370 days before testing	$\leq 1 \% q_{V, max}$	0,98-1,02	$\leq 2 \% q_{V, max}$	$\geq 0,990$
Gas dividers	x/x_{span}	Within 370 days before testing	$\leq 0,5 \% x_{max}$	0,98-1,02	$\leq 2 \% x_{max}$	$\geq 0,990$
Gas analyzers	x	Within 35 days before testing	$\leq 0,5 \% x_{max}$	0,99-1,01	$\leq 1 \% x_{max}$	$\geq 0,998$
PM balance	m	Within 370 days before testing	$\leq 1 \% m_{max}$	0,99-1,01	$\leq 1 \% m_{max}$	$\geq 0,998$
Stand-alone pressures	p	Within 370 days before testing	$\leq 1 \% p_{max}$	0,99-1,01	$\leq 1 \% p_{max}$	$\geq 0,998$
Analog-to-digital conversion of stand-alone temperature signals	T	Within 370 days before testing	$\leq 1 \% T_{max}$	0,99-1,01	$\leq 1 \% T_{max}$	$\geq 0,998$

(1) Molar flow rate may be used instead of standard volumetric flow rate as the term representing 'quantity'. In this case maximum molar flow rate may be used instead of the maximum standard volumetric flow rate in the corresponding linearity criteria.

▼B

8.1.5. Continuous gas analyser system-response and updating-recording verification

This section describes a general verification procedure for continuous gas analyzer system response and update recording. See point 8.1.6 for verification procedures for compensation type analysers.

8.1.5.1. Scope and frequency

This verification shall be performed after installing or replacing a gas analyzer that is used for continuous sampling. Also this verification shall be performed if the system is reconfigured in a way that would change system response. This verification is needed for continuous gas analysers used for transient (NRTC and LSI-NRTC) test cycles or RMC but is not needed for batch gas analyzer systems or for continuous gas analyzer systems used only for testing with a discrete-mode NRSC.

8.1.5.2. Measurement principles

This test verifies that the updating and recording frequencies match the overall system response to a rapid change in the value of concentrations at the sample probe. Gas analyzer systems shall be optimized such that their overall response to a rapid change in concentration is updated and recorded at an appropriate frequency to prevent loss of information. This test also verifies that continuous gas analyzer systems meet a minimum response time.

The system settings for the response time evaluation shall be exactly the same as during measurement of the test run (i.e. pressure, flow rates, filter settings on the analyzers and all other response time influences). The response time determination shall be done with gas switching directly at the inlet of the sample probe. The devices for gas switching shall have a specification to perform the switching in less than 0,1 s. The gases used for the test shall cause a concentration change of at least 60 % full scale (FS).

The concentration trace of each single gas component shall be recorded.

8.1.5.3. System requirements

- (a) The system response time shall be ≤ 10 s with a rise time of ≤ 5 s for all measured components (CO, NO_x, 2 and HC) and all ranges used.

All data (concentration, fuel and air flows) have to be shifted by their measured response times before performing the emission calculations given in Annex VII.

- (b) To demonstrate acceptable updating and recording with respect to the system's overall response, the system shall meet one of the following criteria:

- (i) The product of the mean rise time and the frequency at which the system records an updated concentration shall be at least 5. In any case the mean rise time shall be no more than 10 s;

▼B

- (ii) The frequency at which the system records the concentration shall be at least 2 Hz (see also Table 6.7).

8.1.5.4. Procedure

The following procedure shall be used to verify the response of each continuous gas analyzer system:

- (a) The analyzer system manufacturer's start-up and operating instructions for the instrument setup shall be followed. The measurement system shall be adjusted as needed to optimize performance. This verification shall be run with the analyzer operating in the same manner as used for emission testing. If the analyzer shares its sampling system with other analyzers, and if gas flow to the other analyzers will affect the system response time, then the other analyzers shall be started up and operated while running this verification test. This verification test may be run on multiple analyzers sharing the same sampling system at the same time. If analogue or real-time digital filters are used during emission testing, those filters shall be operated in the same manner during this verification;

- (b) For equipment used to validate system response time, minimal gas transfer line lengths between all connections are recommended to be used, a zero-air source shall be connected to one inlet of a fast-acting 3-way valve (2 inlets, 1 outlet) in order to control the flow of zero and blended span gases to the sample system's probe inlet or a tee near the outlet of the probe. Normally the gas flow rate is higher than the probe sample flow rate and the excess is overflowed out the inlet of the probe. If the gas flow rate is lower than the probe flow rate, the gas concentrations shall be adjusted to account for the dilution from ambient air drawn into the probe. Binary or multi-gas span gases may be used. A gas blending or mixing device may be used to blend span gases. A gas blending or mixing device is recommended when blending span gases diluted in N₂ with span gases diluted in air;

Using a gas divider, an NO-CO-CO₂-C₃H₈-CH₄ (balance N₂) span gas shall be equally blended with a span gas of NO₂, balance purified synthetic air. Standard binary span gases may be also be used, where applicable, in place of blended NO-CO-CO₂-C₃H₈-CH₄, balance N₂ span gas; in this case separate response tests shall be run for each analyzer. The gas divider outlet shall be connected to the other inlet of the 3-way valve. The valve outlet shall be connected to an overflow at the gas analyzer system's probe or to an overflow fitting between the probe and transfer line to all the analyzers being verified. A setup that avoids pressure pulsations due to stopping the flow through the gas blending device shall be used. Any of these gas constituents if they are not relevant to the analyzers for this verification shall be omitted. Alternatively the use of gas bottles with single gases and a separate measurement of response times is allowed;

▼B

- (c) Data collection shall be done as follows:
- (i) The valve shall be switched to start the flow of zero gas;
 - (ii) Stabilization shall be allowed for, accounting for transport delays and the slowest analyzer's full response;
 - (iii) Data recording shall be started at the frequency used during emission testing. Each recorded value shall be a unique updated concentration measured by the analyzer; interpolation or filtering may not be used to alter recorded values;
 - (iv) The valve shall be switched to allow the blended span gases to flow to the analyzers. This time shall be recorded as t_0 ;
 - (v) Transport delays and the slowest analyzer's full response shall be allowed for;
 - (vi) The flow shall be switched to allow zero gas to flow to the analyzer. This time shall be recorded as t_{100} ;
 - (vii) Transport delays and the slowest analyzer's full response shall be allowed for;
 - (viii) The steps in paragraphs (c)(iv) to (vii) of this point shall be repeated to record seven full cycles, ending with zero gas flowing to the analyzers;
 - (ix) Recording shall be stopped.

8.1.5.5. Performance evaluation

The data from point 8.1.5.4(c) shall be used to calculate the mean rise time for each of the analyzers.

- (a) If it is chosen to demonstrate compliance with point 8.1.5.3(b)(i) the following procedure has to be applied: The rise times (in s) shall be multiplied by their respective recording frequencies in Hertz (1/s). The value for each result shall be at least 5. If the value is less than 5, the recording frequency shall be increased or the flows adjusted or the design of the sampling system shall be changed to increase the rise time as needed. Also digital filters may be configured to increase rise time;
- (b) If it is chosen to demonstrate compliance with point 8.1.5.3(b)(ii), the demonstration of compliance with the requirements of point 8.1.5.3(b)(ii) is sufficient.

8.1.6. Response time verification for compensation type analysers**8.1.6.1. Scope and frequency**

This verification shall be performed to determine a continuous gas analyzer's response, where one analyzer's response is compensated by another's to quantify a gaseous emission. For this check water vapour shall be considered to be a gaseous constituent. This verification is required for continuous gas analyzers used for transient

▼ B

(NRTC and LSI-NRTC) test cycles or RMC. This verification is not needed for batch gas analyzers or for continuous gas analyzers that are used only for testing with a discrete-mode NRSC. This verification does not apply to correction for water removed from the sample done in post-processing. This verification shall be performed after initial installation (i.e. test cell commissioning). After major maintenance, point 8.1.5 may be used to verify uniform response provided that any replaced components have gone through a humidified uniform response verification at some point.

8.1.6.2. Measurement principles

This procedure verifies the time-alignment and uniform response of continuously combined gas measurements. For this procedure, it is necessary to ensure that all compensation algorithms and humidity corrections are turned on.

8.1.6.3. System requirements

The general response time and rise time requirement set out in point 8.1.5.3(a) is also valid for compensation type analysers. Additionally, if the recording frequency is different than the update frequency of the continuously combined/compensated signal, the lower of these two frequencies shall be used for the verification required by point 8.1.5.3(b)(i).

8.1.6.4. Procedure

All procedures set out in point 8.1.5.4(a) to (c) shall be used. Additionally also the response and rise time of water vapour has to be measured, if a compensation algorithm based on measured water vapour is used. In this case at least one of the used calibration gases (but not NO₂) has to be humidified as follows:

If the system does not use a sample dryer to remove water from the sample gas, the span gas shall be humidified by flowing the gas mixture through a sealed vessel that humidifies the gas to the highest sample dew point that is estimated during emission sampling by bubbling it through distilled water. If the system uses a sample dryer during testing that has passed the sample dryer verification check, the humidified gas mixture may be introduced downstream of the sample dryer by bubbling it through distilled water in a sealed vessel at 298 ± 10 K (25 ± 10 °C), or a temperature greater than the dew point. In all cases, downstream of the vessel, the humidified gas shall be maintained at a temperature of at least 5 K (5 °C) above its local dew point in the line. Note that it is possible to omit any of these gas constituents if they are not relevant to the analyzers for this verification. If any of the gas constituents are not susceptible to water compensation, the response check for these analyzers may be performed without humidification.

▼ M2

8.1.7. Measurement of engine parameters and ambient conditions

Internal quality procedures traceable to recognised national or international standards shall be applied. Otherwise the following procedures apply.

▼ B

8.1.7.1. Torque calibration

8.1.7.1.1. Scope and frequency

All torque-measurement systems including dynamometer torque measurement transducers and systems shall be calibrated upon initial installation and after major maintenance using, among others, reference force or lever-arm length coupled with dead weight. Good engineering judgment shall be used to repeat the calibration. The torque transducer manufacturer's instructions shall be followed for linearizing the torque sensor's output. Other calibration methods are permitted.

8.1.7.1.2. Dead-weight calibration

This technique applies a known force by hanging known weights at a known distance along a lever arm. It shall be made sure that the weights' lever arm is perpendicular to gravity (i.e., horizontal) and perpendicular to the dynamometer's rotational axis. At least six calibration-weight combinations shall be applied for each applicable torque-measuring range, spacing the weight quantities about equally over the range. The dynamometer shall be oscillated or rotated during calibration to reduce frictional static hysteresis. Each weight's force shall be determined by multiplying its internationally-traceable mass by the local acceleration of Earth's gravity.

8.1.7.1.3. Strain gage or proving ring calibration

This technique applies force either by hanging weights on a lever arm (these weights and their lever arm length are not used as part of the reference torque determination) or by operating the dynamometer at different torques. At least six force combinations shall be applied for each applicable torque-measuring range, spacing the force quantities about equally over the range. The dynamometer shall be oscillated or rotated during calibration to reduce frictional static hysteresis. In this case, the reference torque is determined by multiplying the force output from the reference meter (such as a strain gage or proving ring) by its effective lever-arm length, which is measured from the point where the force measurement is made to the dynamometer's rotational axis. It shall be made sure that this length is measured perpendicular to the reference meter's measurement axis and perpendicular to the dynamometer's rotational axis.

8.1.7.2. Pressure, temperature, and dew point calibration

Instruments shall be calibrated for measuring pressure, temperature, and dew point upon initial installation. The instrument manufacturer's instructions shall be followed and good engineering judgment shall be used to repeat the calibration.

For temperature measurement systems with thermocouple, RTD, or thermistor sensors, the calibration of the system shall be performed as described in point 8.1.4.4 for linearity verification.

8.1.8. Flow-related measurements

8.1.8.1. Fuel flow calibration

Fuel flow meters shall be calibrated upon initial installation. The instrument manufacturer's instructions shall be followed and good engineering judgment shall be used to repeat the calibration.

▼B

8.1.8.2. Intake air flow calibration

Intake air flow meters shall be calibrated upon initial installation. The instrument manufacturer's instructions shall be followed and good engineering judgment shall be used to repeat the calibration.

8.1.8.3. Exhaust gas flow calibration

Exhaust flow meters shall be calibrated upon initial installation. The instrument manufacturer's instructions shall be followed and good engineering judgment shall be used to repeat the calibration.

8.1.8.4. Diluted exhaust gas flow (CVS) calibration

8.1.8.4.1. Overview

(a) This section describes how to calibrate flow meters for diluted exhaust gas constant-volume sampling (CVS) systems;

(b) This calibration shall be performed while the flow meter is installed in its permanent position. This calibration shall be performed after any part of the flow configuration upstream or downstream of the flow meter has been changed that may affect the flow-meter calibration. This calibration shall be performed upon initial CVS installation and whenever corrective action does not resolve a failure to meet the diluted exhaust gas flow verification (*i.e.*, propane check) in point 8.1.8.5;

(c) A CVS flow meter shall be calibrated using a reference flow meter such as a subsonic venturi flow meter, a long-radius flow nozzle, a smooth approach orifice, a laminar flow element, a set of critical flow venturis, or an ultrasonic flow meter. A reference flow meter shall be used that reports quantities that are internationally-traceable within $\pm 1\%$ uncertainty. This reference flow meter's response to flow shall be used as the reference value for CVS flow-meter calibration;

(d) An upstream screen or other pressure restriction that could affect the flow ahead of the reference flow meter may not be used, unless the flow meter has been calibrated with such a pressure restriction;

(e) The calibration sequence described under this point 8.1.8.4 refers to the molar based approach. For the corresponding sequence used in the mass based approach, see point 2.5 of Annex VII.

(f) ►**M2** CFV or SSV may alternatively be removed from its permanent position for calibration as long as the following requirements are met when installed in the CVS: ◀

(1) Upon installation of the CFV or SSV into the CVS, good engineering judgment shall be applied to verify that any leaks have not been introduced between the CVS inlet and the venturi.

▼B

- (2) After ex-situ venturi calibration, all venturi flow combinations must be verified for CFVs or at minimum of 10 flow points for an SSV using the propane check as described in point 8.1.8.5. The result of the propane check for each venturi flow point may not exceed the tolerance in point 8.1.8.5.6.
- (3) In order to verify the ex-situ calibration for a CVS with more than a single CFV, the following verification shall be conducted:
- (i) A constant flow device shall be used to deliver a constant flow of propane to the dilution tunnel.
 - (ii) The hydrocarbon concentrations shall be measured at a minimum of 10 separate flow rates for an SSV flow meter, or at all possible flow combinations for a CFV flow meter, while keeping the flow of propane constant.
 - (iii) The concentration of hydrocarbon background in the dilution air shall be measured at the beginning and end of this test. The average background concentration from each measurement at each flow point must be subtracted before performing the regression analysis in paragraph (iv).
 - (iv) A power regression has to be performed using all the paired values of flow rate and corrected concentration to obtain a relationship in the form of $y = a \times x^b$, using the concentration as the independent variable and the flow rate as the dependent variable. For each data point, the calculation of the difference between the measured flow rate and the value represented by the curve fit is required. The difference at each point must be less than $\pm 1\%$ of the appropriate regression value. The value of b must be between $-1,005$ and $-0,995$. If the results do not meet these limits, corrective actions consistent with point 8.1.8.5.1(a) must be taken.

8.1.8.4.2. PDP calibration

A positive-displacement pump (PDP) shall be calibrated to determine a flow-versus-PDP speed equation that accounts for flow leakage across sealing surfaces in the PDP as a function of PDP inlet pressure. Unique equation coefficients shall be determined for each speed at which the PDP is operated. A PDP flow meter shall be calibrated as follows:

- (a) The system shall be connected as shown in Figure 6.5;
- (b) Leaks between the calibration flow meter and the PDP shall be less than 0,3 % of the total flow at the lowest calibrated flow point; for example, at the highest pressure restriction and lowest PDP-speed point;
- (c) While the PDP operates, a constant temperature at the PDP inlet shall be maintained within $\pm 2\%$ of the mean absolute inlet temperature, T_{in} ;
- (d) The PDP speed is set to the first speed point at which it is intended to calibrate;
- (e) The variable restrictor is set to its wide-open position;

▼ B

- (f) The PDP is operated for at least 3 minutes to stabilize the system. Then by continuously operating the PDP, the mean values of at least 30 s of sampled data of each of the following quantities are recorded:
- (i) The mean flow rate of the reference flow meter, $\bar{q}_{V\text{ref}}$;
 - (ii) The mean temperature at the PDP inlet, T_{in} ;
 - (iii) The mean static absolute pressure at the PDP inlet, p_{in} ;
 - (iv) The mean static absolute pressure at the PDP outlet, p_{out} ;
 - (v) The mean PDP speed, n_{PDP} ;
- (g) The restrictor valve shall be incrementally closed to decrease the absolute pressure at the inlet to the PDP, p_{in} ;
- (h) The steps in paragraphs 8.1.8.4.2(f) and (g) shall be repeated to record data at a minimum of six restrictor positions reflecting the full range of possible in-use pressures at the PDP inlet;
- (i) The PDP shall be calibrated by using the collected data and the equations set out in Annex VII;
- (j) The steps in paragraphs (f) to (i) of this point shall be repeated for each speed at which the PDP is operated;
- (k) The equations in section 3 of Annex VII (molar based approach) or section 2 of Annex VII (mass based approach) shall be used to determine the PDP flow equation for emission testing;
- (l) The calibration shall be verified by performing a CVS verification (i.e., propane check) as described in point 8.1.8.5;
- (m) The PDP may not be used below the lowest inlet pressure tested during calibration.

8.1.8.4.3. CFV calibration

A critical-flow venturi (CFV) shall be calibrated to verify its discharge coefficient, C_d , at the lowest expected static differential pressure between the CFV inlet and outlet. A CFV flow meter shall be calibrated as follows:

- (a) The system shall be connected as shown in Figure 6.5;
- (b) The blower shall be started downstream of the CFV;
- (c) While the CFV operates, a constant temperature at the CFV inlet shall be maintained within $\pm 2\%$ of the mean absolute inlet temperature, T_{in} ;
- (d) Leaks between the calibration flow meter and the CFV shall be less than 0,3 % of the total flow at the highest pressure restriction;
- (e) The variable restrictor shall be set to its wide-open position. In lieu of a variable restrictor the pressure downstream of the CFV may be varied by varying blower speed or by introducing a controlled leak. Note that some blowers have limitations on non-loaded conditions;

▼B

- (f) The CFV shall be operated for at least 3 minutes to stabilize the system. The CFV shall continue operating and the mean values of at least 30 s of sampled data of each of the following quantities shall be recorded:
- (i) The mean flow rate of the reference flow meter, $\bar{q}_{V\text{ref}}$;
 - (ii) Optionally, the mean dew point of the calibration air, T_{dew} . See Annex VII for permissible assumptions during emission measurements;
 - (iii) The mean temperature at the venturi inlet, T_{in} ;
 - (iv) The mean static absolute pressure at the venturi inlet, p_{in} ;
 - (v) The mean static differential pressure between the CFV inlet and the CFV outlet, Δp_{CFV} ;
- (g) The restrictor valve shall be incrementally closed to decrease the absolute pressure at the inlet to the CFV, p_{in} ;
- (h) The steps in paragraphs (f) and (g) of this point shall be repeated to record mean data at a minimum of ten restrictor positions, such that the fullest practical range of Δp_{CFV} expected during testing is tested. It is not required to remove calibration components or CVS components to calibrate at the lowest possible pressure restrictions;
- (i) C_d and the highest allowable pressure ratio r shall be determined as described in Annex VII;
- (j) C_d shall be used to determine CFV flow during an emission test. The CFV shall not be used above the highest allowed r , as determined in Annex VII;
- (k) The calibration shall be verified by performing a CVS verification (*i.e.*, propane check) as described in point 8.1.z8.5;
- (l) If the CVS is configured to operate more than one CFV at a time in parallel, the CVS shall be calibrated by one of the following:
- (i) Every combination of CFVs shall be calibrated according to this section and with Annex VII. See Annex VII for instructions on calculating flow rates for this option;
 - (ii) Each CFV shall be calibrated according to this point and Annex VII. See Annex VII for instructions on calculating flow rates for this option.

8.1.8.4.4. SSV calibration

A subsonic venturi (SSV) shall be calibrated to determine its calibration coefficient, C_d , for the expected range of inlet pressures. An SSV flow meter shall be calibrated as follows:

- (a) The system shall be connected as shown in Figure 6.5;

▼ B

- (b) The blower shall be started downstream of the SSV;
- (c) Leaks between the calibration flow meter and the SSV shall be less than 0,3 % of the total flow at the highest pressure restriction;
- (d) While the SSV operates, a constant temperature at the SSV inlet shall be maintained within ± 2 % of the mean absolute inlet temperature, T_{in} ;
- (e) The variable restrictor or variable-speed blower shall be set to a flow rate greater than the greatest flow rate expected during testing. Flow rates may not be extrapolated beyond calibrated values, so it is recommended that it is made certain that a Reynolds number, Re , at the SSV throat at the greatest calibrated flow rate is greater than the maximum Re expected during testing;
- (f) The SSV shall be operated for at least 3 min to stabilize the system. The SSV shall continue operating and the mean of at least 30 s of sampled data of each of the following quantities shall be recorded:
 - (i) The mean flow rate of the reference flow meter, \bar{q}_{Vref} ;
 - (ii) Optionally, the mean dew point of the calibration air, T_{dew} . See Annex VII for permissible assumptions;
 - (iii) The mean temperature at the venturi inlet, T_{in} ;
 - (iv) The mean static absolute pressure at the venturi inlet, p_{in} ;
 - (v) Static differential pressure between the static pressure at the venturi inlet and the static pressure at the venturi throat, Δp_{SSV} ;
- (g) The restrictor valve shall be incrementally closed or the blower speed decreased to decrease the flow rate;
- (h) The steps in paragraphs (f) and (g) of this point shall be repeated to record data at a minimum of ten flow rates;
- (i) A functional form of C_d versus Re shall be determined by using the collected data and the equations in Annex VII;
- (j) The calibration shall be verified by performing a CVS verification (*i.e.*, propane check) as described in point 8.1.8.5 using the new C_d versus Re equation;
- (k) The SSV shall be used only between the minimum and maximum calibrated flow rates;
- (l) The equations in section 3 of Annex VII (molar based approach) or section 2 of Annex VII (mass based approach) shall be used to determine SSV flow during a test.

▼ **B**

8.1.8.4.5. Ultrasonic calibration (reserved)

Figure 6.5

Schematic diagrams for diluted exhaust gas flow CVS calibration

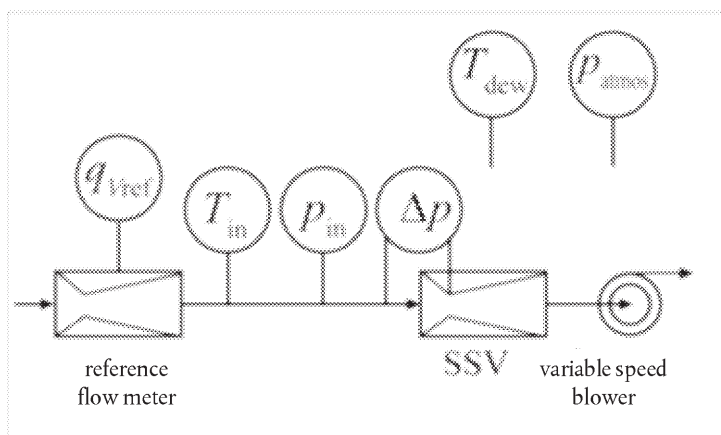
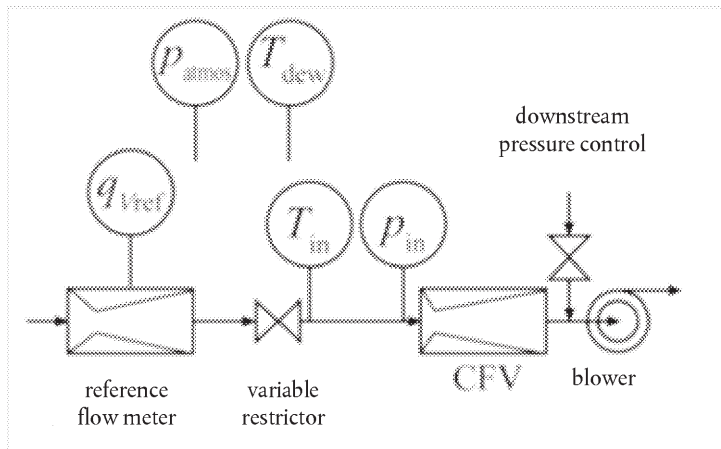
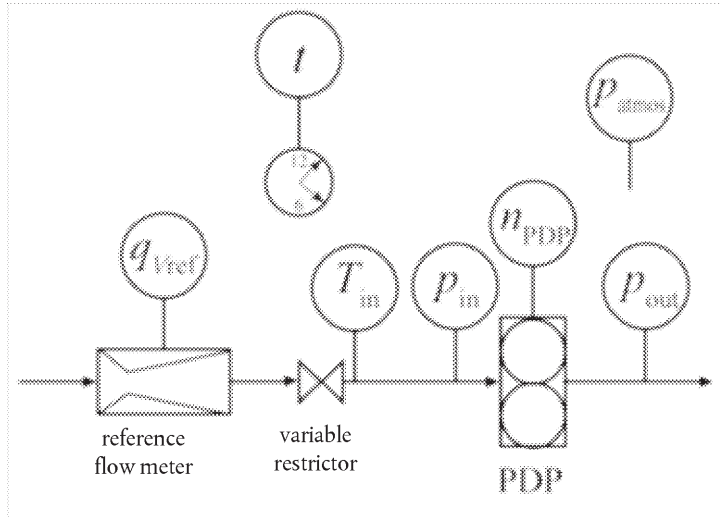

▼ B

8.1.8.5. CVS and batch sampler verification (propane check)

8.1.8.5.1. Introduction

(a) A propane check serves as a CVS verification to determine if there is a discrepancy in measured values of diluted exhaust gas flow. A propane check also serves as a batch-sampler verification to determine if there is a discrepancy in a batch sampling system that extracts a sample from a CVS, as described in paragraph (f) of this point. Using good engineering judgment and safe practices, this check may be performed using a gas other than propane, such as CO₂ or CO. A failed propane check might indicate one or more problems that may require corrective action, as follows:

- (i) Incorrect analyzer calibration. The FID analyzer shall be re-calibrated, repaired, or replaced;
- (ii) Leak checks shall be performed on CVS tunnel, connections, fasteners, and HC sampling system according to point 8.1.8.7;
- (iii) The verification for poor mixing shall be performed in accordance with point 9.2.2;

▼ M2

- (iv) The hydrocarbon contamination verification in the sample system shall be performed as described in point 7.3.1.3;

▼ B

- (v) Change in CVS calibration. An in-situ calibration of the CVS flow meter shall be performed as described in point 8.1.8.4;

- (vi) Other problems with the CVS or sampling verification hardware or software. The CVS system, CVS verification hardware, and software shall be inspected for discrepancies;

(b) A propane check uses either a reference mass or a reference flow rate of C₃H₈ as a tracer gas in a CVS. If a reference flow rate is used, any non-ideal gas behaviour of C₃H₈ in the reference flow meter shall be accounted for. See section 2 of Annex VII (mass based approach) or section 3 of Annex VII (molar based approach), which describe how to calibrate and use certain flow meters. No ideal gas assumption may be used in point 8.1.8.5 and Annex VII. The propane check compares the calculated mass of injected C₃H₈ using HC measurements and CVS flow rate measurements with the reference value.

8.1.8.5.2. Method of introducing a known amount of propane into the CVS system

The total accuracy of the CVS sampling system and analytical system shall be determined by introducing a known mass of a pollutant gas into the system while it is being operated in the normal manner. The pollutant is analyzed, and the mass calculated in accordance with Annex VII. Either of the following two techniques shall be used:

- (a) Metering by means of a gravimetric technique shall be done as follows: A mass of a small cylinder filled with carbon monoxide or propane shall be determined with a precision of ± 0,01 g. For about 5 to 10 minutes, the CVS system shall be operated as in a normal exhaust emissions test, while carbon monoxide or propane is injected into the system. The quantity of pure gas discharged shall be determined by means of differential weighing. A gas sample shall be analyzed with the usual equipment (sampling bag or integrating method), and the mass of the gas calculated;

▼ B

- (b) Metering with a critical flow orifice shall be done as follows: A known quantity of pure gas (carbon monoxide or propane) shall be fed into the CVS system through a calibrated critical orifice. If the inlet pressure is high enough, the flow rate, which is adjusted by means of the critical flow orifice, is independent of the orifice outlet pressure (critical flow). The CVS system shall be operated as in a normal exhaust emissions test for about 5 to 10 minutes. A gas sample shall be analyzed with the usual equipment (sampling bag or integrating method), and the mass of the gas calculated.

8.1.8.5.3. Preparation of the propane check

The propane check shall be prepared as follows:

- (a) If a reference mass of C_3H_8 is used instead of a reference flow rate, a cylinder charged with C_3H_8 shall be obtained. The reference cylinder's mass of C_3H_8 shall be determined within $\pm 0,5\%$ of the amount of C_3H_8 that is expected to be used;
- (b) Appropriate flow rates shall be selected for the CVS and C_3H_8 ;
- (c) A C_3H_8 injection port shall be selected in the CVS. The port location shall be selected to be as close as practical to the location where engine exhaust system is introduced into the CVS. The C_3H_8 cylinder shall be connected to the injection system;
- (d) The CVS shall be operated and stabilized;
- (e) Any heat exchangers in the sampling system shall be pre-heated or pre-cooled;
- (f) Heated and cooled components such as sample lines, filters, chillers, and pumps shall be allowed to stabilize at operating temperature;
- (g) If applicable, a vacuum side leak verification of the HC sampling system shall be performed as described in point 8.1.8.7.

8.1.8.5.4. Preparation of the HC sampling system for the propane check

► **M2** Vacuum side leak check verification of the HC sampling system may be performed in accordance with point (g). If this procedure is used, the HC contamination procedure set out in point 7.3.1.3 may be used. ◀ If the vacuum side leak check is not performed according to paragraph (g), then the HC sampling system shall be zeroed, spanned, and verified for contamination, as follows:

- (a) The lowest HC analyzer range that can measure the C_3H_8 concentration expected for the CVS and C_3H_8 flow rates shall be selected;
- (b) The HC analyzer shall be zeroed using zero air introduced at the analyzer port;
- (c) The HC analyzer shall be spanned using C_3H_8 span gas introduced at the analyzer port;
- (d) Zero air shall be overflowed at the HC probe or into a fitting between the HC probe and the transfer line;
- (e) The stable HC concentration of the HC sampling system shall be measured as overflow zero air flows. For batch HC measurement, the batch container (such as a bag) shall be filled and the HC overflow concentration measured;

▼B

- (f) If the overflow HC concentration exceeds 2 $\mu\text{mol/mol}$, the procedure may not be advanced until contamination is eliminated. The source of the contamination shall be determined and corrective action taken, such as cleaning the system or replacing contaminated portions;
- (g) When the overflow HC concentration does not exceed 2 $\mu\text{mol/mol}$, this value shall be recorded as x_{HCinit} and it shall be used to correct for HC contamination as described in section 2 of Annex VII (mass based approach) or section 3 of Annex VII (molar based approach).

8.1.8.5.5. Propane check performance

- (a) The propane check shall be performed as follows:
 - (i) For batch HC sampling, clean storage media, such as evacuated bags shall be connected;
 - (ii) HC measurement instruments shall be operated according to the instrument manufacturer's instructions;
 - (iii) If correction for dilution air background concentrations of HC is foreseen, background HC in the dilution air shall be measured and recorded;
 - (iv) Any integrating devices shall be zeroed;
 - (v) Sampling shall begin and any flow integrators shall be started;
 - (vi) C_3H_8 shall be released at the rate selected. If a reference flow rate of C_3H_8 is used, the integration of this flow rate shall be started;
 - (vii) C_3H_8 shall be continued to be released until at least enough C_3H_8 has been released to ensure accurate quantification of the reference C_3H_8 and the measured C_3H_8 ;
 - (viii) The C_3H_8 cylinder shall be shut off and sampling shall continue until it has been accounted for time delays due to sample transport and analyzer response;
 - (ix) Sampling shall be stopped and any integrators shall be stopped;
- (b) In case the metering with a critical flow orifice is used, the following procedure may be used for the propane check as the alternative method of point 8.1.8.5.5(a):
 - (i) For batch HC sampling, clean storage media, such as evacuated bags shall be connected;
 - (ii) HC measurement instruments shall be operated according to the instrument manufacturer's instructions;
 - (iii) If correction for dilution air background concentrations of HC is foreseen, background HC in the dilution air shall be measured and recorded;
 - (iv) Any integrating devices shall be zeroed;
 - (v) The contents of the C_3H_8 reference cylinder shall be released at the rate selected;

▼B

- (vi) Sampling shall begin, and any flow integrators started after confirming that HC concentration is to be stable;
- (vii) The cylinder's contents shall be continued to be released until at least enough C_3H_8 has been released to ensure accurate quantification of the reference C_3H_8 and the measured C_3H_8 ;
- (viii) Any integrators shall be stopped;
- (ix) The C_3H_8 reference cylinder shall be shut off.

8.1.8.5.6. Evaluation of the propane check

Post-test procedure shall be performed as follows:

- (a) If batch sampling has been used, batch samples shall be analyzed as soon as practical;
- (b) After analyzing HC, contamination and background shall be corrected for;
- (c) Total C_3H_8 mass based on the CVS and HC data shall be calculated as described in Annex VII, using the molar mass of C_3H_8 , $M_{C_3H_8}$, instead of the effective molar mass of HC, M_{HC} ;
- (d) If a reference mass (gravimetric technique) is used, the cylinder's propane mass shall be determined within $\pm 0,5\%$ and the C_3H_8 reference mass shall be determined by subtracting the empty cylinder propane mass from the full cylinder propane mass. If a critical flow orifice (metering with a critical flow orifice) is used, the propane mass shall be determined as flow rate multiplied by the test time;
- (e) The reference C_3H_8 mass shall be subtracted from the calculated mass. If this difference is within $\pm 3,0\%$ of the reference mass, the CVS passes this verification.

8.1.8.5.7. PM secondary dilution system verification

When the propane check is to be repeated to verify the PM secondary dilution system, the following procedure from (a) to (d) shall be used for this verification:

- (a) The HC sampling system shall be configured to extract a sample near the location of the batch sampler's storage media (such as a PM filter). If the absolute pressure at this location is too low to extract an HC sample, HC may be sampled from the batch sampler pump's exhaust. Caution shall be used when sampling from pump's exhaust because an otherwise acceptable pump leak downstream of a batch sampler flow meter will cause a false failure of the propane check;
- (b) The propane check shall be repeated as described in this point, but HC shall be sampled from the batch sampler;
- (c) C_3H_8 mass shall be calculated, taking into account any secondary dilution from the batch sampler;
- (d) The reference C_3H_8 mass shall be subtracted from the calculated mass. If this difference is within $\pm 5\%$ of the reference mass, the batch sampler passes this verification. If not, corrective action shall be taken.

▼ M2▼ B

8.1.8.6. Periodic calibration of the partial flow PM and associated raw exhaust gas measurement systems

8.1.8.6.1. Specifications for differential flow measurement

For partial flow dilution systems to extract a proportional raw exhaust gas sample, the accuracy of the sample flow q_{mp} is of special concern, if not measured directly, but determined by differential flow measurement as set out in equation (6-20):

$$q_{mp} = q_{mdew} - q_{mdw} \quad (6-20)$$

Where:

q_{mp} is the sample mass flow rate of exhaust gas into partial flow dilution system

q_{mdw} is the dilution air mass flow rate (on wet basis)

q_{mdew} is the diluted exhaust gas mass flow rate on wet basis

In this case, the maximum error of the difference shall be such that the accuracy of q_{mp} is within $\pm 5\%$ when the dilution ratio is less than 15. It can be calculated by taking root-mean-square of the errors of each instrument.

Acceptable accuracies of q_{mp} can be obtained by either of the following methods:

- (a) The absolute accuracies of q_{mdew} and q_{mdw} are $\pm 0,2\%$ which guarantees an accuracy of q_{mp} of $\leq 5\%$ at a dilution ratio of 15. However, greater errors will occur at higher dilution ratios;
- (b) Calibration of q_{mdw} relative to q_{mdew} is carried out such that the same accuracies for q_{mp} as in (a) are obtained. For details see point 8.1.8.6.2;
- (c) The accuracy of q_{mp} is determined indirectly from the accuracy of the dilution ratio as determined by a tracer gas, e.g. CO₂. Accuracies equivalent to method (a) for q_{mp} are required;
- (d) The absolute accuracy of q_{mdew} and q_{mdw} is within $\pm 2\%$ of full scale, the maximum error of the difference between q_{mdew} and q_{mdw} is within $0,2\%$ and the linearity error is within $\pm 0,2\%$ of the highest q_{mdew} observed during the test.

8.1.8.6.2. Calibration of differential flow measurement

The partial flow dilution system to extract a proportional raw exhaust gas sample shall be periodically calibrated with an accurate flow meter traceable to international and/or national standards. The flow meter or the flow measurement instrumentation shall be calibrated in one of the following procedures, such that the probe flow q_{mp} into the tunnel shall fulfil the accuracy requirements of point 8.1.8.6.1.

- (a) The flow meter for q_{mdw} shall be connected in series to the flow meter for q_{mdew} , the difference between the two flow meters shall be calibrated for at least 5 set points with flow values equally spaced between the lowest q_{mdw} value used during the test and the value of q_{mdew} used during the test. The dilution tunnel may be bypassed;

▼ B

- (b) A calibrated flow device shall be connected in series to the flowmeter for q_{mdew} and the accuracy shall be checked for the value used for the test. The calibrated flow device shall be connected in series to the flow meter for q_{mdw} , and the accuracy shall be checked for at least 5 settings corresponding to dilution ratio between 3 and 15, relative to q_{mdew} used during the test;
- (c) The transfer line TL (see Figure 6.7) shall be disconnected from the exhaust system and a calibrated flow measuring device with a suitable range to measure q_{mp} shall be connected to the transfer line. q_{mdew} shall be set to the value used during the test, and q_{mdw} shall be sequentially set to at least 5 values corresponding to dilution ratios between 3 and 15. Alternatively, a special calibration flow path may be provided, in which the tunnel is bypassed, but the total and dilution air flow is passed through the corresponding meters as in the actual test;
- (d) A tracer gas, shall be fed into the exhaust system transfer line TL. This tracer gas may be a component of the exhaust gas, like CO₂ or NO_x. After dilution in the tunnel the tracer gas component shall be measured. This shall be carried out for 5 dilution ratios between 3 and 15. The accuracy of the sample flow shall be determined from the dilution ratio r_d by means of equation (6-21):

$$q_{mp} = q_{mdew} / r_d \quad (6-21)$$

The accuracies of the gas analyzers shall be taken into account to guarantee the accuracy of q_{mp} .

8.1.8.6.3. Special requirements for differential flow measurement

A carbon flow check using actual exhaust gas is strongly recommended for detecting measurement and control problems and verifying the proper operation of the partial flow system. The carbon flow check should be run at least each time a new engine is installed, or something significant is changed in the test cell configuration.

The engine shall be operated at peak torque load and speed or any other steady state mode that produces 5 % or more of CO₂. The partial flow sampling system shall be operated with a dilution factor of about 15 to 1.

If a carbon flow check is conducted, Appendix 2 of Annex VII shall be applied. The carbon flow rates shall be calculated according to equations of Appendix 2 of Annex VII. All carbon flow rates shall agree to within 5 %.

8.1.8.6.3.1. Pre-test check

A pre-test check shall be performed within 2 hours before the test run in the following way.

The accuracy of the flow meters shall be checked by the same method as used for calibration (see point 8.1.8.6.2) for at least two points, including flow values of q_{mdw} that correspond to dilution ratios between 5 and 15 for the q_{mdew} value used during the test.

If it can be demonstrated by records of the calibration procedure under point 8.1.8.6.2 that the flow meter calibration is stable over a longer period of time, the pre-test check may be omitted.

▼ B

8.1.8.6.3.2. Determination of the transformation time

The system settings for the transformation time evaluation shall be the same as during measurement of the test run. The transformation time, as defined in point 2.4 of Appendix 5 to this Annex and in figure 6-11, shall be determined by the following method:

An independent reference flowmeter with a measurement range appropriate for the probe flow shall be put in series with and closely coupled to the probe. This flowmeter shall have a transformation time of less than 100 ms for the flow step size used in the response time measurement, with flow pressure restriction sufficiently low as to not affect the dynamic performance of the partial flow dilution system according to good engineering judgment. A step change shall be introduced to the exhaust gas flow (or air flow if exhaust gas flow is calculated) input of the partial flow dilution system, from a low flow to at least 90 % of full scale. The trigger for the step change shall be the same one used to start the look-ahead control in actual testing. The exhaust gas flow step stimulus and the flowmeter response shall be recorded at a sample rate of at least 10 Hz.

From this data, the transformation time shall be determined for the partial flow dilution system, which is the time from the initiation of the step stimulus to the 50 % point of the flowmeter response. In a similar manner, the transformation times of the q_{mp} signal (i.e. sample flow of exhaust gas into partial flow dilution system) and of the $q_{mew,i}$ signal (i.e. the exhaust gas mass flow rate on wet basis supplied by the exhaust flow meter) shall be determined. These signals are used in the regression checks performed after each test (see point 8.2.1.2).

The calculation shall be repeated for at least 5 rise and fall stimuli, and the results shall be averaged. The internal transformation time (< 100 ms) of the reference flowmeter shall be subtracted from this value. Where look-ahead control is required, the look-ahead value of the partial flow dilution system shall be applied in accordance with point 8.2.1.2.

8.1.8.7. Vacuum-side leak verification

8.1.8.7.1. Scope and frequency

Upon initial sampling system installation, after major maintenance such as pre-filter changes, and within 8 hours prior to each duty-cycle sequence, it shall be verified that there are no significant vacuum-side leaks using one of the leak tests described in this section. This verification does not apply to any full-flow portion of a CVS dilution system.

8.1.8.7.2. Measurement principles

A leak may be detected either by measuring a small amount of flow when there shall be zero flow, by detecting the dilution of a known concentration of span gas when it flows through the vacuum side of a sampling system or by measuring the pressure increase of an evacuated system.

8.1.8.7.3. Low-flow leak test

A sampling system shall be tested for low-flow leaks as follows:

▼B

- (a) The probe end of the system shall be sealed by taking one of the following steps:
 - (i) The end of the sample probe shall be capped or plugged;
 - (ii) The transfer line shall be disconnected at the probe and the transfer line capped or plugged;
 - (iii) A leak-tight valve in-line between a probe and transfer line shall be closed;
- (b) All vacuum pumps shall be operated. After stabilizing, it shall be verified that the flow through the vacuum-side of the sampling system is less than 0,5 % of the system's normal in-use flow rate. Typical analyzer and bypass flows may be estimated as an approximation of the system's normal in-use flow rate.

8.1.8.7.4. Dilution-of-span-gas leak test

Any gas analyzer may be used for this test. If a FID is used for this test, any HC contamination in the sampling system shall be corrected in accordance with sections 2 or 3 of Annex VII on HC determination. Misleading results shall be avoided by using only analyzers that have a repeatability of 0,5 % or better at the span gas concentration used for this test. The vacuum side leak check shall be performed as follows:

- (a) A gas analyzer shall be prepared as it would be for emission testing;
- (b) Span gas shall be supplied to the analyzer port and it shall be verified that the span gas concentration is measured within its expected measurement accuracy and repeatability;
- (c) Overflow span gas shall be routed to one of the following locations in the sampling system:
 - (i) The end of the sample probe;
 - (ii) The transfer line shall be disconnected at the probe connection, and the span gas overflowed at the open end of the transfer line;
 - (iii) A three-way valve installed in-line between a probe and its transfer line;
- (d) It shall be verified that the measured overflow span gas concentration is within $\pm 0,5$ % of the span gas concentration. A measured value lower than expected indicates a leak, but a value higher than expected may indicate a problem with the span gas or the analyzer itself. A measured value higher than expected does not indicate a leak.

8.1.8.7.5. Vacuum-decay leak test

To perform this test a vacuum shall be applied to the vacuum-side volume of the sampling system and the leak rate of the system shall be observed as a decay in the applied vacuum. To perform this test the vacuum-side volume of the sampling system shall be known to within ± 10 % of its true volume. For this test measurement instruments that meet the specifications of points 8.1 and 9.4 shall also be used.

▼B

A vacuum-decay leak test shall be performed as follows:

- (a) The probe end of the system shall be sealed as close to the probe opening as possible by taking one of the following steps:
 - (i) The end of the sample probe shall be capped or plugged;
 - (ii) The transfer line at the probe shall be disconnected and the transfer line capped or plugged;
 - (iii) A leak-tight valve in-line between a probe and transfer line shall be closed;
- (b) All vacuum pumps shall be operated. A vacuum shall be drawn that is representative of normal operating conditions. In the case of sample bags, it is recommend that the normal sample bag pump-down procedure be repeated twice to minimize any trapped volumes;
- (c) The sample pumps shall be turned off and the system sealed. The absolute pressure of the trapped gas and optionally the system absolute temperature shall be measured and recorded. Sufficient time shall be allowed for any transients to settle and long enough for a leak at 0,5 % to have caused a pressure change of at least 10 times the resolution of the pressure transducer. The pressure and optionally temperature shall be recorded once again;
- (d) The leak flow rate based on an assumed value of zero for pumped-down bag volumes and based on known values for the sample system volume, the initial and final pressures, optional temperatures, and elapsed time shall be calculated. It shall be verified that the vacuum-decay leak flow rate is less than 0,5 % of the system's normal in-use flow rate by means of equation (6-22):

$$q_{V\text{leak}} = \frac{V_{\text{vac}} \left(\frac{p_2}{T_2} - \frac{p_1}{T_1} \right)}{R (t_2 - t_1)} \quad (6-22)$$

Where:

$q_{V\text{leak}}$ is the vacuum-decay leak rate, mol/s

V_{vac} is the geometric volume of the vacuum-side of the sampling system, m³

R is the molar gas constant, J/(mol · K)

p_2 is the vacuum-side absolute pressure at time t_2 , Pa

T_2 is the vacuum-side absolute temperature at time t_2 , K

p_1 is the vacuum-side absolute pressure at time t_1 , Pa

T_1 is the vacuum-side absolute temperature at time t_1 , K

t_2 is the time at completion of vacuum-decay leak verification test, s

t_1 is the time at start of vacuum-decay leak verification test, s

▼ B

8.1.9. CO and CO₂ measurements

8.1.9.1. H₂O interference verification for CO₂ NDIR analyzers

8.1.9.1.1. Scope and frequency

If CO₂ is measured using an NDIR analyzer, the amount of H₂O interference shall be verified after initial analyzer installation and after major maintenance.

▼ M2

8.1.9.1.2. Measurement principles

H₂O can interfere with an NDIR analyzer's response to CO₂. If the NDIR analyzer uses compensation algorithms that utilize measurements of other gases to meet this interference verification, these other measurements shall be conducted simultaneously to test the compensation algorithms during the analyzer interference verification.

▼ B

8.1.9.1.3. System requirements

A CO₂ NDIR analyzer shall have an H₂O interference that is within (0,0 ± 0,4) mmol/mol (of the expected mean CO₂ concentration).

8.1.9.1.4. Procedure

The interference verification shall be performed as follows:

(a) The CO₂ NDIR analyzer shall be started, operated, zeroed, and spanned as it would be before an emission test;

▼ M2

(b) A humidified test gas shall be created by bubbling zero air that meets the specifications set out in point 9.5.1 through distilled water in a sealed vessel. If the sample is not passed through a dryer, control the vessel temperature to generate an H₂O content in the test gas at least as high as the maximum expected during testing. If the sample is passed through a dryer during testing, control the vessel temperature to generate an H₂O content in the test gas at least as high as the maximum expected at the outlet of the dryer, in accordance with point 9.3.2.3.1.1;

▼ B

(c) The humidified test gas temperature shall be maintained at least 5 °K above its dew point downstream of the vessel;

(d) The humidified test gas shall be introduced into the sampling system. The humidified test gas may be introduced downstream of any sample dryer, if one is used during testing;

(e) The water mole fraction, $x_{\text{H}_2\text{O}}$, of the humidified test gas shall be measured, as close as possible to the inlet of the analyzer. For example, dew point, T_{dew} , and absolute pressure p_{total} , shall be measured to calculate $x_{\text{H}_2\text{O}}$;

(f) Good engineering judgment shall be used to prevent condensation in the transfer lines, fittings, or valves from the point where $x_{\text{H}_2\text{O}}$ is measured to the analyzer;

(g) Time shall be allowed for the analyzer response to stabilize. Stabilization time shall include time to purge the transfer line and to account for analyzer response;

▼ B

(h) While the analyzer measures the sample's concentration, 30 s of sampled data shall be recorded. The arithmetic mean of this data shall be calculated. The analyzer meets the interference verification if this value is within $(0,0 \pm 0,4)$ mmol/mol.

8.1.9.2. H₂O and CO₂ interference verification for CO NDIR analyzers

8.1.9.2.1. Scope and frequency

If CO is measured using an NDIR analyzer, the amount of H₂O and CO₂ interference shall be verified after initial analyzer installation and after major maintenance.

8.1.9.2.2. Measurement principles

H₂O and CO₂ can positively interfere with an NDIR analyzer by causing a response similar to CO. If the NDIR analyzer uses compensation algorithms that utilize measurements of other gases to meet this interference verification, simultaneously these other measurements shall be conducted to test the compensation algorithms during the analyzer interference verification.

8.1.9.2.3. System requirements

A CO NDIR analyzer shall have combined H₂O and CO₂ interference that is within $\pm 2\%$ of the expected mean concentration of CO.

8.1.9.2.4. Procedure

The interference verification shall be performed as follows:

(a) The CO NDIR analyzer shall be started, operated, zeroed, and spanned as it would be before an emission test;

▼ M2

(b) A humidified CO₂ test gas shall be created by bubbling a CO₂ span gas through distilled water in a sealed vessel. If the sample is not passed through a dryer, the vessel temperature shall be controlled to generate an H₂O content in the test gas at least as high as the maximum expected during testing. If the sample is passed through a dryer during testing, the vessel temperature shall be controlled to generate an H₂O content in the test gas at least as high as the maximum expected at the outlet of the dryer, in accordance with point 9.3.2.3.1.1. A CO₂ span gas concentration shall be used at least as high as the maximum expected during testing;

▼ B

(c) The humidified CO₂ test gas shall be introduced into the sampling system. The humidified CO₂ test gas may be introduced downstream of any sample dryer, if one is used during testing;

(d) The water mole fraction, $x_{\text{H}_2\text{O}}$, of the humidified test gas shall be measured, as close as possible to the inlet of the analyzer. For example, dew point, T_{dew} , and absolute pressure p_{total} , shall be measured to calculate $x_{\text{H}_2\text{O}}$;

(e) Good engineering judgment shall be used to prevent condensation in the transfer lines, fittings, or valves from the point where $x_{\text{H}_2\text{O}}$ is measured to the analyzer;

▼ B

- (f) Time shall be allowed for the analyzer response to stabilize;
- (g) While the analyzer measures the sample's concentration, its output shall be recorded for 30 s. The arithmetic mean of this data shall be calculated;
- (h) The analyzer meets the interference verification if the result of paragraph (g) of this point meets the tolerance in point 8.1.9.2.3;
- (i) Interference procedures for CO₂ and H₂O may be also run separately. If the CO₂ and H₂O levels used are higher than the maximum levels expected during testing, each observed interference value shall be scaled down by multiplying the observed interference by the ratio of the maximum expected concentration value to the actual value used during this procedure. Separate interference procedures concentrations of H₂O (down to 0,025 mol/mol H₂O content) that are lower than the maximum levels expected during testing may be run, but the observed H₂O interference shall be scaled up by multiplying the observed interference by the ratio of the maximum expected H₂O concentration value to the actual value used during this procedure. The sum of the two scaled interference values shall meet the tolerance in point 8.1.9.2.3.

8.1.10. Hydrocarbon measurements

8.1.10.1. FID optimization and verification

8.1.10.1.1. Scope and frequency

For all FID analyzers, the FID shall be calibrated upon initial installation. The calibration shall be repeated as needed using good engineering judgment. The following steps shall be performed for a FID that measures HC:

- (a) A FID's response to various hydrocarbons shall be optimized after initial analyzer installation and after major maintenance. FID response to propylene and toluene shall be between 0,9 and 1,1 relative to propane;
- (b) A FID's methane (CH₄) response factor shall be determined after initial analyzer installation and after major maintenance as described in point 8.1.10.1.4;
- (c) Methane (CH₄) response shall be verified within 185 days before testing.

8.1.10.1.2. Calibration

Good engineering judgment shall be used to develop a calibration procedure, such as one based on the FID-analyzer manufacturer's instructions and recommended frequency for calibrating the FID. The FID shall be calibrated using C₃H₈ calibration gases that meet the specifications of point 9.5.1. It shall be calibrated on a carbon number basis of one (C₁).

8.1.10.1.3. HC FID response optimization

This procedure is only for FID analyzers that measure HC.

▼ B

- (a) Instrument manufacturer requirements and good engineering judgment shall be used for initial instrument start-up and basic operating adjustment using FID fuel and zero air. Heated FIDs shall be within their required operating temperature ranges. FID response shall be optimized to meet the requirement of the hydrocarbon response factors and the oxygen interference check according to points 8.1.10.1.1(a) and 8.1.10.2 at the most common analyzer range expected during emission testing. Higher analyzer range may be used according to the instrument manufacturer's recommendation and good engineering judgment in order to optimize FID accurately, if the common analyzer range is lower than the minimum range for the optimization specified by the instrument manufacturer;
- (b) Heated FIDs shall be within their required operating temperature ranges. FID response shall be optimized at the most common analyzer range expected during emission testing. ► **M2** With the FID fuel and airflow rates set at the manufacturer's recommendations, a span gas shall be introduced to the analyzer; ◀
- (c) The following steps from (i) to (iv) or the procedure instructed by the instrument manufacturer shall be taken for optimization. The procedures outlined in SAE paper No 770141 may be optionally used for optimization;

▼ M2

- (i) The response at a given FID fuel flow shall be determined from the difference between the span gas response and the zero gas response;

▼ B

- (ii) The fuel flow shall be incrementally adjusted above and below the manufacturer's specification. ► **M2** The span and zero response at these FID fuel flows shall be recorded; ◀
- (iii) The difference between the span and zero response shall be plotted and the fuel flow adjusted to the rich side of the curve. This is the initial flow rate setting which may need further optimization depending on the results of the hydrocarbon response factors and the oxygen interference check according to points 8.1.10.1.1(a) and 8.1.10.2;
- (iv) If the oxygen interference or the hydrocarbon response factors do not meet the following specifications, the airflow shall be incrementally adjusted above and below the manufacturer's specifications, repeating points 8.1.10.1.1(a) and 8.1.10.2 for each flow;
- (d) The optimum flow rates and/or pressures for FID fuel and burner air shall be determined, and they shall be sampled and recorded for future reference.

8.1.10.1.4. HC FID CH₄ response factor determination

Since FID analyzers generally have a different response to CH₄ versus C₃H₈, each HC FID analyzer's CH₄ response factor, $RF_{CH_4[THC-FID]}$ shall be determined, after FID optimization. The most recent $RF_{CH_4[THC-FID]}$ measured in accordance with this

▼B

section shall be used in the calculations for HC determination described in section 2 of Annex VII (mass based approach) or section 3 of Annex VII (molar based approach) to compensate for CH₄ response. $RF_{CH_4[THC-FID]}$ shall be determined as follows:

- (a) A C₃H₈ span gas concentration shall be selected to span the analyzer before emission testing. Only span gases that meet the specifications of point 9.5.1 shall be selected and the C₃H₈ concentration of the gas shall be recorded;
- (b) A CH₄ span gas that meets the specifications of point 9.5.1 shall be selected and the CH₄ concentration of the gas shall be recorded,
- (c) The FID analyzer shall be operated according to the manufacturer's instructions;
- (d) It shall be confirmed that the FID analyzer has been calibrated using C₃H₈. Calibration shall be performed on a carbon number basis of one (C₁);
- (e) The FID shall be zeroed with a zero gas used for emission testing;
- (f) The FID shall be spanned with the selected C₃H₈ span gas;
- (g) The CH₄ span gas selected in accordance with paragraph (b) shall be introduced at the sample port of the FID analyzer;
- (h) The analyzer response shall be stabilized. Stabilization time may include time to purge the analyzer and to account for its response;
- (i) While the analyzer measures the CH₄ concentration, 30 s of sampled data shall be recorded and the arithmetic mean of these values shall be calculated;
- (j) The mean measured concentration shall be divided by the recorded span concentration of the CH₄ calibration gas. The result is the FID analyzer's response factor for CH₄, $RF_{CH_4[THC-FID]}$.

8.1.10.1.5. HC FID methane (CH₄) response verification

If the value of $RF_{CH_4[THC-FID]}$ obtained in accordance with point 8.1.10.1.4 is within $\pm 5,0\%$ of its most recent previously determined value, the HC FID passes the methane response verification.

- (a) It shall be first verified that the pressures and / or flow rates of FID fuel, burner air, and sample are each within $\pm 0,5\%$ of their most recent previously recorded values, as described in point 8.1.10.1.3. If these flow rates have to be adjusted, a new $RF_{CH_4[THC-FID]}$ shall be determined as described in point 8.1.10.1.4. It should be verified that the value of $RF_{CH_4[THC-FID]}$ determined is within the tolerance specified in this point 8.1.10.1.5;
- (b) If $RF_{CH_4[THC-FID]}$ is not within the tolerance specified in this point 8.1.10.1.5, the FID response shall be re-optimized as described in point 8.1.10.1.3;

▼ B

- (c) A new $RF_{\text{CH}_4[\text{THC-FID}]}$ shall be determined as described in point 8.1.10.1.4. This new value of $RF_{\text{CH}_4[\text{THC-FID}]}$ shall be used in the calculations for HC determination, in section 2 of Annex VII (mass based approach) or section 3 of Annex VII (molar based approach).

8.1.10.2. Non-stoichiometric raw exhaust gas FID O₂ interference verification

8.1.10.2.1. Scope and frequency

If FID analyzers are used for raw exhaust gas measurements, the amount of FID O₂ interference shall be verified upon initial installation and after major maintenance.

8.1.10.2.2. Measurement principles

Changes in O₂ concentration in raw exhaust gas can affect FID response by changing FID flame temperature. FID fuel, burner air, and sample flow shall be optimized to meet this verification. FID performance shall be verified with the compensation algorithms for FID O₂ interference that is active during an emission test.

8.1.10.2.3. System requirements

Any FID analyzer used during testing shall meet the FID O₂ interference verification according to the procedure in this section.

8.1.10.2.4. Procedure

FID O₂ interference shall be determined as follows, noting that one or more gas dividers may be used to create reference gas concentrations that are required to perform this verification:

- (a) Three span reference gases that meet the specifications set out in point 9.5.1 and contain C₃H₈ concentration shall be selected to span the analyzers before emissions testing.
► M2 ————— ◀ The three balance gas concentrations shall be selected such that the concentrations of O₂ and N₂ represent the minimum and maximum and intermediate O₂ concentrations expected during testing. The requirement for using the average O₂ concentration can be removed if the FID is calibrated with span gas balanced with the average expected oxygen concentration;
- (b) It shall be confirmed that the FID analyzer meets all the specifications of point 8.1.10.1;
- (c) The FID analyzer shall be started and operated as it would be before an emission test. Regardless of the FID burner's air source during testing, zero air shall be used as the FID burner's air source for this verification;
- (d) The analyzer shall be set at zero;
- (e) The analyzer shall be spanned using a span gas that is used during emissions testing;

▼ B

- (f) The zero response shall be checked by using the zero gas used during emission testing. It shall be proceeded to the next step if the mean zero response of 30 s of sampled data is within $\pm 0,5\%$ of the span reference value used in paragraph (e) of this point, otherwise the procedure shall be restarted at paragraph (d) of this point;
- (g) The analyzer response shall be checked using the span gas that has the minimum concentration of O_2 expected during testing. The mean response of 30 s of stabilized sample data shall be recorded as $x_{O2minHC}$;
- (h) The zero response of the FID analyzer shall be checked using the zero gas used during emission testing. The next step shall be performed if the mean zero response of 30 s of stabilized sample data is within $\pm 0,5\%$ of the span reference value used in paragraph (e) of this point, otherwise the procedure shall be restarted at paragraph (d) of this point;
- (i) The analyzer response shall be checked using the span gas that has the average concentration of O_2 expected during testing. The mean response of 30 s of stabilized sample data shall be recorded as $x_{O2avgHC}$;
- (j) The zero response of the FID analyzer shall be checked using the zero gas used during emission testing. The next step shall be performed if the mean zero response of 30 s of stabilized sample data is within $\pm 0,5\%$ of the span reference value used in paragraph (e) of this point, otherwise the procedure shall be restarted at paragraph (d) of this point;
- (k) The analyzer response shall be checked using the span gas that has the maximum concentration of O_2 expected during testing. The mean response of 30 s of stabilized sample data shall be recorded as $x_{O2maxHC}$;
- (l) The zero response of the FID analyzer shall be checked using the zero gas used during emission testing. The next step shall be performed if the mean zero response of 30 s of stabilized sample data is within $\pm 0,5\%$ of the span reference value used in paragraph (e) of this point, otherwise the procedure shall be restarted at paragraph (d) of this point;
- (m) The % difference between $x_{O2maxHC}$ and its reference gas concentration shall be calculated. The percent difference between $x_{O2avgHC}$ and its reference gas concentration shall be calculated. The % difference between $x_{O2minHC}$ and its reference gas concentration shall be calculated. The maximum % difference of the three shall be determined. This is the O_2 interference;
- (n) If the O_2 interference is within $\pm 3\%$, the FID passes the O_2 interference verification; otherwise one or more of the following need to be performed to address the deficiency:

▼ B

- (i) The verification shall be repeated to determine if a mistake was made during the procedure;
- (ii) The zero and span gases for emission testing shall be selected that contain higher or lower O₂ concentrations and the verification shall be repeated;
- (iii) The FID burner air, fuel, and sample flow rates shall be adjusted. Note that if these flow rates are adjusted on a THC FID to meet the O₂ interference verification, the RF_{CH_4} shall be reset for the next RF_{CH_4} verification. The O₂ interference verification shall be repeated after adjustment and RF_{CH_4} shall be determined;
- (iv) The FID shall be repaired or replaced and the O₂ interference verification shall be repeated.

8.1.10.3. Non-methane cutter penetration fractions (Reserved)

8.1.11. NO_x measurements

8.1.11.1. CLD CO₂ and H₂O quench verification

8.1.11.1.1. Scope and frequency

If a CLD analyzer is used to measure NO_x, the amount of H₂O and CO₂ quench shall be verified after installing the CLD analyzer and after major maintenance.

8.1.11.1.2. Measurement principles

H₂O and CO₂ can negatively interfere with a CLD's NO_x response by collisional quenching, which inhibits the chemiluminescent reaction that a CLD utilizes to detect NO_x. This procedure and the calculations in point 8.1.11.2.3 determine quench and scale the quench results to the maximum mole fraction of H₂O and the maximum CO₂ concentration expected during emission testing. If the CLD analyzer uses quench compensation algorithms that utilize H₂O and/or CO₂ measurement instruments, quench shall be evaluated with these instruments active and with the compensation algorithms applied.

8.1.11.1.3. System requirements

For dilute measurement a CLD analyzer shall not exceed a combined H₂O and CO₂ quench of ± 2 %. For raw measurement a CLD analyzer shall not exceed a combined H₂O and CO₂ quench of ± 2,5 %. Combined quench is the sum of the CO₂ quench determined as described in point 8.1.11.1.4 and the H₂O quench as determined in point 8.1.11.1.5. If these requirements are not met, corrective action shall be taken by repairing or replacing the analyzer. Before running emission tests, it shall be verified that the corrective action have successfully restored the analyzer to proper functioning.

8.1.11.1.4. CO₂ quench verification procedure

The following method or the method prescribed by the instrument manufacturer may be used to determine CO₂ quench by using a gas

▼B

divider that blends binary span gases with zero gas as the diluent and meets the specifications in point 9.4.5.6, or good engineering judgment shall be used to develop a different protocol:

- (a) PTFE or stainless steel tubing shall be used to make necessary connections;
- (b) The gas divider shall be configured such that nearly equal amounts of the span and diluent gases are blended with each other;
- (c) If the CLD analyzer has an operating mode in which it detects NO-only, as opposed to total NO_x, the CLD analyzer shall be operated in the NO-only operating mode;
- (d) A CO₂ span gas that meets the specifications of point 9.5.1 and a concentration that is approximately twice the maximum CO₂ concentration expected during emission testing shall be used;
- (e) An NO span gas that meets the specifications of point 9.5.1 and a concentration that is approximately twice the maximum NO concentration expected during emission testing shall be used. Higher concentration may be used according to the instrument manufacturer's recommendation and good engineering judgement in order to obtain accurate verification, if the expected NO concentration is lower than the minimum range for the verification specified by the instrument manufacturer;
- (f) The CLD analyzer shall be zeroed and spanned. The CLD analyzer shall be spanned with the NO span gas from paragraph (e) of this point through the gas divider. The NO span gas shall be connected to the span port of the gas divider; a zero gas shall be connected to the diluent port of the gas divider; the same nominal blend ratio shall be used as selected in paragraph (b) of this point; and the gas divider's output concentration of NO shall be used to span the CLD analyzer. Gas property corrections shall be applied as necessary to ensure accurate gas division;
- (g) The CO₂ span gas shall be connected to the span port of the gas divider;
- (h) The NO span gas shall be connected to the diluents port of the gas divider;
- (i) While flowing NO and CO₂ through the gas divider, the output of the gas divider shall be stabilized. The CO₂ concentration from the gas divider output shall be determined, applying gas property correction as necessary to ensure accurate gas division. This concentration, $x_{\text{CO}_2\text{act}}$, shall be recorded and it shall be used in the quench verification calculations in point 8.1.11.2.3. As an alternative to using a gas divider, another simple gas blending device may be used. In this case an analyzer shall be used to determine CO₂ concentration. If a NDIR is used together with a simple gas blending device, it shall meet the requirements of this section and it shall be spanned with the CO₂ span gas from paragraph (d) of this point. The linearity of the NDIR analyzer has to be checked before over the whole range up to twice of the expected maximum CO₂ concentration expected during testing;

▼ B

- (j) The NO concentration shall be measured downstream of the gas divider with the CLD analyzer. Time shall be allowed for the analyzer response to stabilize. Stabilization time may include time to purge the transfer line and to account for analyzer response. While the analyzer measures the sample's concentration, the analyzer's output shall be recorded for 30 seconds. The arithmetic mean concentration shall be calculated from these data, x_{NOmeas} . x_{NOmeas} shall be recorded and it shall be used in the quench verification calculations in point 8.1.11.2.3;
- (k) The actual NO concentration shall be calculated at the gas divider's outlet, x_{NOact} , based on the span gas concentrations and x_{CO2act} by means of equation (6-24). The calculated value shall be used in the quench verification calculations by means of equation (6-23);
- (l) The values recorded according to this points 8.1.11.1.4 and 8.1.11.1.5 shall be used to calculate quench as described in point 8.1.11.2.3.

8.1.11.1.5. H₂O quench verification procedure

The following method or the method prescribed by the instrument manufacturer may be used to determine H₂O quench, or good engineering judgment shall be used to develop a different protocol:

- (a) PTFE or stainless steel tubing shall be used to make necessary connections;
- (b) If the CLD analyzer has an operating mode in which it detects NO-only, as opposed to total NO_x, the CLD analyzer shall be operated in the NO-only operating mode;
- (c) A NO span gas shall be used that meets the specifications of point 9.5.1 and a concentration that is near the maximum concentration expected during emission testing. Higher concentration may be used according to the instrument manufacturer's recommendation and good engineering judgement in order to obtain accurate verification, if the expected NO concentration is lower than the minimum range for the verification specified by the instrument manufacturer;
- (d) The CLD analyzer shall be zeroed and spanned. The CLD analyzer shall be spanned with the NO span gas from paragraph (c) of this point, the span gas concentration shall be recorded as x_{NOdry} , and it shall be used in the quench verification calculations in point 8.1.11.2.3;

▼ M2

- (e) The NO span gas shall be humidified by bubbling it through distilled water in a sealed vessel. If the humidified NO span gas sample does not pass through a sample dryer for this verification test, the vessel temperature shall be controlled to generate an H₂O content in the span gas approximately equal to the maximum mole fraction of H₂O expected during emission testing. If the humidified NO span gas sample does not pass through a sample dryer, the quench verification calculations in point 8.1.11.2.3 scale the measured H₂O quench to the highest mole fraction of H₂O expected during emission

▼ **M2**

testing. If the humidified NO span gas sample passes through a dryer for this verification test, the vessel temperature shall be controlled to generate an H₂O content in the span gas at least as high as the maximum expected at the outlet of the dryer in accordance with point 9.3.2.3.1.1. In this case, the quench verification calculations set out in point 8.1.11.2.3 do not scale the measured H₂O quench;

▼ **B**

- (f) The humidified NO test gas shall be introduced into the sample system. It may be introduced upstream or downstream of a sample dryer that is used during emission testing. Depending on the point of introduction, the respective calculation method of paragraph (e) of this point shall be selected. ► **M2** Note that the sample dryer shall meet the sample dryer verification check in point 8.1.12; ◀
- (g) The mole fraction of H₂O in the humidified NO span gas shall be measured. In case a sample dryer is used, the mole fraction of H₂O in the humidified NO span gas shall be measured downstream of the sample dryer, $x_{\text{H}_2\text{Omeas}}$. It is recommended to measure $x_{\text{H}_2\text{Omeas}}$ as close as possible to the CLD analyzer inlet. $x_{\text{H}_2\text{Omeas}}$ may be calculated from measurements of dew point, T_{dew} , and absolute pressure, p_{total} ;
- (h) Good engineering judgment shall be used to prevent condensation in the transfer lines, fittings, or valves from the point where $x_{\text{H}_2\text{Omeas}}$ is measured to the analyzer. It is recommended that the system is designed so the wall temperatures in the transfer lines, fittings, and valves from the point where $x_{\text{H}_2\text{Omeas}}$ is measured to the analyzer are at least 5 K above the local sample gas dew point;
- (i) The humidified NO span gas concentration shall be measured with the CLD analyzer. Time shall be allowed for the analyzer response to stabilize. Stabilization time may include time to purge the transfer line and to account for analyzer response. While the analyzer measures the sample's concentration, the analyzer's output shall be recorded for 30 seconds. The arithmetic mean shall be calculated of these data, x_{NOwet} . x_{NOwet} shall be recorded and used in the quench verification calculations in point 8.1.11.2.3.

8.1.11.2. CLD quench verification calculations

CLD quench-check calculations shall be performed as described in this point.

8.1.11.2.1. Amount of water expected during testing

The maximum expected mole fraction of water during emission testing, $x_{\text{H}_2\text{Oexp}}$ shall be estimated. This estimate shall be made where the humidified NO span gas was introduced in point 8.1.11.1.5(f). When estimating the maximum expected mole fraction of water, the maximum expected water content in combustion air, fuel combustion products, and dilution air (if applicable) shall be considered. If the humidified NO span gas is introduced into the sample system upstream of a sample dryer during the verification test, it is not needed to estimate the maximum expected mole fraction of water and $x_{\text{H}_2\text{Oexp}}$ shall be set equal to $x_{\text{H}_2\text{Omeas}}$.

▼B8.1.11.2.2. Amount of CO₂ expected during testing

The maximum expected CO₂ concentration during emission testing, $x_{\text{CO}_2\text{exp}}$ shall be estimated. This estimate shall be made at the sample system location where the blended NO and CO₂ span gases are introduced according to point 8.1.11.1.4(j). When estimating the maximum expected CO₂ concentration, the maximum expected CO₂ content in fuel combustion products and dilution air shall be considered.

8.1.11.2.3. Combined H₂O and CO₂ quench calculations

Combined H₂O and CO₂ quench shall be calculated by means of equation (6-23):

$$\text{quench} = \left[\left(\frac{x_{\text{NOwet}}}{1 - x_{\text{H}_2\text{Omeas}}} \right) \cdot \frac{x_{\text{H}_2\text{Oexp}}}{x_{\text{H}_2\text{Omeas}}} + \left(\frac{x_{\text{NOmeas}}}{x_{\text{NOact}}} - 1 \right) \cdot \frac{x_{\text{CO}_2\text{exp}}}{x_{\text{CO}_2\text{act}}} \right] \cdot 100\% \quad (6-23)$$

Where:

quench = amount of CLD quench

x_{NOdry} is the measured concentration of NO upstream of a bubbler, in accordance with point 8.1.11.1.5(d)

x_{NOwet} is the measured concentration of NO downstream of a bubbler, in accordance with point 8.1.11.1.5(i)

$x_{\text{H}_2\text{Oexp}}$ is the maximum expected mole fraction of water during emission testing in accordance with point 8.1.11.2.1.

$x_{\text{H}_2\text{Omeas}}$ is the measured mole fraction of water during the quench verification in accordance with point 8.1.11.1.5(g)

x_{NOmeas} is the measured concentration of NO when NO span gas is blended with CO₂ span gas, in accordance with point 8.1.11.1.4(j)

x_{NOact} is the actual concentration of NO when NO span gas is blended with CO₂ span gas, in accordance with point 8.1.11.1.4(k) and calculated by means of equation (6-24)

$x_{\text{CO}_2\text{exp}}$ is the maximum expected concentration of CO₂ during emission testing, in accordance with point 8.1.11.2.2.

$x_{\text{CO}_2\text{act}}$ is the actual concentration of CO₂ when NO span gas is blended with CO₂ span gas, in accordance with point 8.1.11.1.4(i)

$$x_{\text{NOact}} = \left(1 - \frac{x_{\text{CO}_2\text{act}}}{x_{\text{CO}_2\text{span}}} \right) \cdot x_{\text{NOspan}} \quad (6-24)$$

Where:

x_{NOspan} is the NO span gas concentration input to the gas divider, in accordance with point 8.1.11.1.4(e)

$x_{\text{CO}_2\text{span}}$ is the CO₂ span gas concentration input to the gas divider, in accordance with point 8.1.11.1.4(d)

▼ B8.1.11.3. NDUV analyzer HC and H₂O interference verification

8.1.11.3.1. Scope and frequency

If NO_x is measured using an NDUV analyzer, the amount of H₂O and hydrocarbon interference shall be verified after initial analyzer installation and after major maintenance.

8.1.11.3.2. Measurement principles

Hydrocarbons and H₂O can positively interfere with a NDUV analyzer by causing a response similar to NO_x. If the NDUV analyzer uses compensation algorithms that utilize measurements of other gases to meet this interference verification, simultaneously such measurements shall be conducted to test the algorithms during the analyzer interference verification.

8.1.11.3.3. System requirements

A NO_x NDUV analyzer shall have combined H₂O and HC interference within ± 2 % of the mean concentration of NO_x.

8.1.11.3.4. Procedure

The interference verification shall be performed as follows:

- (a) The NO_x NDUV analyzer shall be started, operated, zeroed, and spanned according to the instrument manufacturer's instructions;
- (b) It is recommended to extract engine exhaust gas to perform this verification. A CLD shall be used that meets the specifications of point 9.4 to quantify NO_x in the exhaust gas. The CLD response shall be used as the reference value. Also HC shall be measured in the exhaust gas with a FID analyzer that meets the specifications of point 9.4. The FID response shall be used as the reference hydrocarbon value;
- (c) Upstream of any sample dryer, if one is used during testing, the engine exhaust gas shall be introduced into the NDUV analyzer;
- (d) Time shall be allowed for the analyzer response to stabilize. Stabilization time may include time to purge the transfer line and to account for analyzer response;
- (e) While all analyzers measure the sample's concentration, 30 s of sampled data shall be recorded, and the arithmetic means for the three analyzers calculated;
- (f) The CLD mean shall be subtracted from the NDUV mean;
- (g) ► **M2** This difference shall be multiplied by the ratio of the expected mean HC concentration to the HC concentration measured during the verification. The analyzer meets the interference verification of this point if this result is within ± 2 % of the NO_x concentration expected at the emission limit value, as set out in equation (6-25): ◀

$$|\bar{x}_{\text{NO}_x, \text{CLD, meas}} - \bar{x}_{\text{NO}_x, \text{NDUV, meas}}| \cdot \left(\frac{\bar{X}_{\text{HC, exp}}}{\bar{X}_{\text{HC, meas}}} \right) \leq 2\% \cdot (\bar{x}_{\text{NO}_x, \text{exp}}) \quad (6-25)$$

▼ B

Where:

$\bar{x}_{\text{NOx,CLD,meas}}$	is the mean concentration of NO _x measured by CLD [$\mu\text{mol/mol}$] or [ppm]
$\bar{x}_{\text{NOx,NDUV,meas}}$	is the mean concentration of NO _x measured by NDUV [$\mu\text{mol/mol}$] or [ppm]
$\bar{x}_{\text{HC,meas}}$	is the mean concentration of HC measured [$\mu\text{mol/mol}$] or [ppm]
$\bar{x}_{\text{HC,exp}}$	is the mean concentration of HC expected at the standard [$\mu\text{mol/mol}$] or [ppm]
$\bar{x}_{\text{NOx,exp}}$	is the mean concentration of NO _x expected at the standard [$\mu\text{mol/mol}$] or [ppm]

8.1.11.4 Sample dryer NO₂ penetration

8.1.11.4.1. Scope and frequency

If a sample dryer is used to dry a sample upstream of a NO_x measurement instrument, but no NO₂-to-NO converter is used upstream of the sample dryer, this verification shall be performed for sample dryer NO₂ penetration. This verification shall be performed after initial installation and after major maintenance.

8.1.11.4.2. Measurement principles

A sample dryer removes water, which can otherwise interfere with a NO_x measurement. However, liquid water remaining in an improperly designed ►**M2** sample dryer ◀ can remove NO₂ from the sample. If a sample dryer is used without an NO₂-to-NO converter upstream, it could therefore remove NO₂ from the sample prior NO_x measurement.

8.1.11.4.3. System requirements

The sample dryer shall allow for measuring at least 95 % of the total NO₂ at the maximum expected concentration of NO₂.

8.1.11.4.4. Procedure

The following procedure shall be used to verify sample dryer performance:

- (a) Instrument setup. The analyzer and sample dryer manufacturers' start-up and operating instructions shall be followed. The analyzer and sample dryer shall be adjusted as needed to optimize performance;
- (b) Equipment setup and data collection.
 - (i) The total NO_x gas analyzer(s) shall be zeroed and spanned as it would be before emission testing;
 - (ii) NO₂ calibration gas (balance gas of dry air) that has an NO₂ concentration that is near the maximum expected during testing shall be selected. Higher concentration may be used in accordance with the instrument manufacturer's recommendation and good engineering judgement in order to obtain accurate verification, if the expected NO₂ concentration is lower than the minimum range for the verification specified by the instrument manufacturer;

▼ B

- (iii) This calibration gas shall be overflowed at the gas sampling system's probe or overflow fitting. Time shall be allowed for stabilization of the total NO_x response, accounting only for transport delays and instrument response;
 - (iv) The mean of 30 s of recorded total NO_x data shall be calculated and this value recorded as x_{NOxref} ;
 - (v) The flowing the NO₂ calibration gas shall be stopped;
 - (vi) Next the sampling system shall be saturated by overflowing a dew point generator's output, set at a dew point of 323 K (50 °C), to the gas sampling system's probe or overflow fitting. The dew point generator's output shall be sampled through the sampling system and sample dryer for at least 10 minutes until the sample dryer is expected to be removing a constant rate of water;
 - (vii) It shall be immediately switched back to overflowing the NO₂ calibration gas used to establish x_{NOxref} . It shall be allowed for stabilization of the total NO_x response, accounting only for transport delays and instrument response. The mean of 30 s of recorded total NO_x data shall be calculated and this value recorded as x_{NOxmeas} ;
 - (viii) x_{NOxmeas} shall be corrected to x_{NOxdry} based upon the residual water vapour that passed through the sample dryer at the sample dryer's outlet temperature and pressure;
- (c) Performance evaluation. If x_{NOxdry} is less than 95 % of x_{NOxref} , the sample dryer shall be repaired or replaced.

8.1.11.5. NO₂-to-NO converter conversion verification

8.1.11.5.1. Scope and frequency

If an analyzer is used that measures only NO to determine NO_x, an NO₂-to-NO converter shall be used upstream of the analyzer. This verification shall be performed after installing the converter, after major maintenance and within 35 days before an emission test. This verification shall be repeated at this frequency to verify that the catalytic activity of the NO₂-to-NO converter has not deteriorated.

8.1.11.5.2. Measurement principles

An NO₂-to-NO converter allows an analyzer that measures only NO to determine total NO_x by converting the NO₂ in exhaust gas to NO.

8.1.11.5.3. System requirements

An NO₂-to-NO converter shall allow for measuring at least 95 % of the total NO₂ at the maximum expected concentration of NO₂.

8.1.11.5.4 Procedure

The following procedure shall be used to verify the performance of a NO₂-to-NO converter:

▼ B

- (a) For the instrument setup the analyzer and NO₂-to-NO converter manufacturers' start-up and operating instructions shall be followed. The analyzer and converter shall be adjusted as needed to optimize performance;
- (b) An ozonator's inlet shall be connected to a zero-air or oxygen source and its outlet shall be connected to one port of a 3-way tee fitting. An NO span gas shall be connected to another port and the NO₂-to-NO converter inlet shall be connected to the last port;
- (c) The following steps shall be taken when performing this check:
- (i) The ozonator air shall be set off and the ozonator power shall be turned off and the NO₂-to-NO converter shall be set to the bypass mode (i.e., NO mode). Stabilization shall be allowed for, accounting only for transport delays and instrument response;
 - (ii) The NO and zero-gas flows shall be adjusted so the NO concentration at the analyzer is near the peak total NO_x concentration expected during testing. The NO₂ content of the gas mixture shall be less than 5 % of the NO concentration. The concentration of NO shall be recorded by calculating the mean of 30 s of sampled data from the analyzer and this value shall be recorded as x_{NOref} . Higher concentration may be used according to the instrument manufacturer's recommendation and good engineering judgement in order to obtain accurate verification, if the expected NO concentration is lower than the minimum range for the verification specified by the instrument manufacturer;
 - (iii) The ozonator O₂ supply shall be turned on and the O₂ flow rate adjusted so that the NO indicated by the analyzer is about 10 percent less than x_{NOref} . The concentration of NO shall be recorded by calculating the mean of 30 s of sampled data from the analyzer and this value recorded as $x_{\text{NO+O2mix}}$;
 - (iv) The ozonator shall be switched on and the ozone generation rate adjusted so that the NO measured by the analyzer is approximately 20 percent of x_{NOref} , while maintaining at least 10 % unreacted NO. The concentration of NO shall be recorded by calculating the mean of 30 s of sampled data from the analyzer and this value shall be recorded as x_{NOmeas} ;
 - (v) The NO_x analyzer shall be switched to NO_x mode and total NO_x measured. The concentration of NO_x shall be recorded by calculating the mean of 30 s of sampled data from the analyzer and this value shall be recorded as x_{NOxmeas} ;
 - (vi) The ozonator shall be switched off but gas flow through the system shall be maintained. The NO_x analyzer will indicate the NO_x in the NO + O₂ mixture. The concentration of NO_x shall be recorded by calculating the mean of 30 s of sampled data from the analyzer and this value shall be recorded as $x_{\text{NOx+O2mix}}$;

▼ B

- (vii) O₂ supply shall be turned off. The NO_x analyzer will indicate the NO_x in the original NO-in-N₂ mixture. The concentration of NO_x shall be recorded by calculating the mean of 30 s of sampled data from the analyzer and this value shall be recorded as x_{NOxref} . This value shall be no more than 5 % above the x_{NOref} value;
- (d) Performance evaluation. The efficiency of the NO_x converter shall be calculated by substituting the concentrations obtained into equation (6-26):

$$\text{Efficiency [\%]} = \left(1 + \frac{x_{\text{NOxmeas}} - x_{\text{NOx+O2mix}}}{x_{\text{NO+O2mix}} - x_{\text{NOmeas}}} \right) \times 100 \quad (6-26)$$

- (e) If the result is less than 95 %, the NO₂-to-NO converter shall be repaired or replaced.

▼ M2

8.1.12. Sample dryer verification

If a humidity sensor for continuous monitoring of dew point at the sample dryer outlet is used this check does not apply, as long as it is ensured that the dryer outlet humidity is below the minimum values used for quench, interference, and compensation checks.

If a sample dryer is used as allowed in point 9.3.2.3.1 to remove water from the sample gas, the performance shall be verified upon installation, after major maintenance, for thermal chillers. For osmotic membrane dryers, the performance shall be verified upon installation, after major maintenance, and within 35 days of testing.

Water can inhibit an analyzer's ability to properly measure the exhaust component of interest and thus is sometimes removed before the sample gas reaches the analyzer. For example water can negatively interfere with a CLD's NO_x response through collisional quenching and can positively interfere with an NDIR analyzer by causing a response similar to CO.

The sample dryer shall meet the specifications as determined in point 9.3.2.3.1 for dew point, T_{dew} , and absolute pressure, p_{total} , downstream of the osmotic-membrane dryer or thermal chiller.

The following sample dryer verification procedure method shall be used to determine sample dryer performance, or good engineering judgment shall be used to develop a different protocol:

- (i) polytetrafluoroethylene ('PTFE') or stainless steel tubing shall be used to make necessary connections;
- (ii) N₂ or purified air shall be humidified by bubbling it through distilled water in a sealed vessel that humidifies the gas to the highest sample dew point that is estimated during emission sampling;
- (iii) The humidified gas shall be introduced upstream of the sample dryer;
- (iv) The humidified gas temperature downstream of the vessel shall be maintained at least 5 K (5 °C) above its dew point;

▼ M2

- (v) The humidified gas dew point, T_{dew} , and pressure, p_{total} , shall be measured as close as possible to the inlet of the sample dryer to verify that the dew point is the highest that was estimated during emission sampling;
- (vi) The humidified gas dew point, T_{dew} , and pressure, p_{total} , shall be measured as close as possible to the outlet of the sample dryer;
- (vii) The sample dryer meets the verification if the result of point (d)(vi) of this section is less than the dew point corresponding to the sample dryer specifications as determined in point 9.3.2.3.1 plus 2 K (2 °C) or if the mol fraction from (d)(vi) is less than the corresponding sample dryer specifications plus 0,002 mol/mol or 0,2 volume %. Note for this verification, sample dew point is expressed in absolute temperature, Kelvin.

8.1.13. PM measurements

8.1.13.1. PM balance verifications and weighing process verification

8.1.13.1.1. Scope and frequency

This section describes three verifications.

- (a) Independent verification of PM balance performance within 370 days prior to weighing any filter;
- (b) Zero and span of the balance within 12 h prior to weighing any filter;
- (c) Verification that the mass determination of reference filters before and after a filter weighing session be less than a specified tolerance.

8.1.13.1.2. Independent verification

The balance manufacturer (or a representative approved by the balance manufacturer) shall verify the balance performance within 370 days of testing in accordance with internal audit procedures.

8.1.13.1.3. Zeroing and spanning

Balance performance shall be verified by zeroing and spanning it with at least one calibration weight, and any weights that are used shall meet the specifications in point 9.5.2 to perform that verification. A manual or automated procedure shall be used:

- (a) A manual procedure requires that the balance shall be used in which the balance shall be zeroed and spanned with at least one calibration weight. If normally mean values are obtained by repeating the weighing process to improve the accuracy and precision of PM measurements, the same process shall be used to verify balance performance;
- (b) An automated procedure is carried out with internal calibration weights that are used automatically to verify balance performance. These internal calibration weights shall meet the specifications in point 9.5.2 to perform that verification.

▼ M2

8.1.13.1.4. Reference sample weighing

All mass readings during a weighing session shall be verified by weighing reference PM sample media (e.g. filters) before and after a weighing session. A weighing session may be as short as desired, but no longer than 80 hours, and may include both pre- and post-test mass readings. Successive mass determinations of each reference PM sample media shall return the same value within $\pm 10 \mu\text{g}$ or $\pm 10 \%$ of the expected total PM mass, whichever is higher. Should successive PM sample filter weighing events fail that criterion, all individual test filter mass readings occurring between the successive reference filter mass determinations shall be invalidated. These filters may be re-weighed in another weighing session. Should a post-test filter be invalidated then the test interval is void. That verification shall be performed as follows:

- (a) At least two samples of unused PM sample media shall be kept in the PM-stabilization environment. These shall be used as references. Unused filters of the same material and size shall be selected for use as references;
- (b) References shall be stabilized in the PM stabilization environment. References shall be considered stabilized if they have been in the PM-stabilization environment for a minimum of 30 min, and the PM-stabilization environment has been within the specifications of point 9.3.4.4 for at least the preceding 60 min;
- (c) The balance shall be exercised several times with a reference sample without recording the values;
- (d) The balance shall be zeroed and spanned. A test mass shall be placed on the balance (e.g. calibration weight) and then removed ensuring that the balance returns to an acceptable zero reading within the normal stabilization time;
- (e) Each of the reference media (e.g. filters) shall be weighed and their masses recorded. If normally mean values are obtained by repeating the weighing process to improve the accuracy and precision of reference media (e.g. filters) masses, the same process shall be used to measure mean values of sample media (e.g. filters) masses;
- (f) The balance environment dew point, ambient temperature, and atmospheric pressure shall be recorded;
- (g) The recorded ambient conditions shall be used to correct results for buoyancy as described in point 8.1.13.2. The buoyancy-corrected mass of each of the references shall be recorded;
- (h) Each of the reference media's (e.g. filter's) buoyancy-corrected reference mass shall be subtracted from its previously measured and recorded buoyancy-corrected mass;
- (i) If any of the reference filters' observed mass changes by more than that allowed under this section, all PM mass determinations made since the last successful reference media (e.g. filter) mass validation shall be invalidated. Reference PM filters may be discarded if only one of the filters mass has changed by more than the allowable amount and a special cause for that filter's

▼ M2

mass change can be positively identified which would not have affected other in-process filters. Thus the validation can be considered a success. In that case, the contaminated reference media shall not be included when determining compliance with paragraph (j) of this point, but the affected reference filter shall be discarded and replaced;

- (j) If any of the reference masses change by more than that allowed under point 8.1.13.1.4, all PM results that were determined between the two times that the reference masses were determined shall be invalidated. If reference PM sample media is discarded in accordance with point (i), at least one reference mass difference that meets the criteria set out in point 8.1.13.1.4 shall be available. Otherwise, all PM results that were determined between the two times that the reference media (e.g. filters) masses were determined shall be invalidated.

8.1.13.2. PM sample filter buoyancy correction

8.1.13.2.1. General

PM sample filter shall be corrected for their buoyancy in air. The buoyancy correction depends on the sample media density, the density of air, and the density of the calibration weight used to calibrate the balance. The buoyancy correction does not account for the buoyancy of the PM itself, because the mass of PM typically accounts for only (0,01 to 0,10) % of the total weight. A correction to this small fraction of mass would be at the most 0,010 %. The buoyancy-corrected values are the tare masses of the PM samples. These buoyancy-corrected values of the pre-test filter weighing are subsequently subtracted from the buoyancy-corrected values of the post-test weighing of the corresponding filter to determine the mass of PM emitted during the test.

8.1.13.2.2. PM sample filter density

Different PM sample filter have different densities. The known density of the sample media shall be used, or one of the densities for some common sampling media shall be used, as follows:

- (a) For PTFE-coated borosilicate glass, a sample media density of $2\,300\text{ kg/m}^3$ shall be used;
- (b) For PTFE membrane (film) media with an integral support ring of polymethylpentene that accounts for 95 % of the media mass, a sample media density of 920 kg/m^3 shall be used;
- (c) For PTFE membrane (film) media with an integral support ring of PTFE, a sample media density of $2\,144\text{ kg/m}^3$ shall be used.

8.1.13.2.3. Air density

Because a PM balance environment shall be tightly controlled to an ambient temperature of $295 \pm 1\text{ K}$ ($22 \pm 1\text{ °C}$) and a dew point of $282,5 \pm 1\text{ K}$ ($9,5 \pm 1\text{ °C}$), air density is primarily function of atmospheric pressure. Therefore a buoyancy correction is specified that is only a function of atmospheric pressure.

8.1.13.2.4. Calibration weight density

The stated density of the material of the metal calibration weight shall be used.

8.1.13.2.5. Correction calculation

The PM sample filter shall be corrected for buoyancy by means of equation (6-27):

▼ M2

$$m_{\text{cor}} = m_{\text{uncor}} \cdot \left(\frac{1 - \frac{\rho_{\text{air}}}{\rho_{\text{weight}}}}{1 - \frac{\rho_{\text{air}}}{\rho_{\text{media}}}} \right) \quad (6-27)$$

Where:

- m_{cor} is the PM sample filter mass corrected for buoyancy
- m_{uncor} is the PM sample filter mass uncorrected for buoyancy
- ρ_{air} is the density of air in balance environment
- ρ_{weight} is the density of calibration weight used to span balance
- ρ_{media} is the density of PM sample filter

with

$$\rho_{\text{air}} = \frac{p_{\text{abs}} \cdot M_{\text{mix}}}{R \cdot T_{\text{amb}}} \quad (6-28)$$

Where:

- p_{abs} is the absolute pressure in balance environment
- M_{mix} is the molar mass of air in balance environment
- R is the molar gas constant.
- T_{amb} is the absolute ambient temperature of balance environment

▼ B

- 8.2. Instrument validation for test
- 8.2.1. Validation of proportional flow control for batch sampling and minimum dilution ratio for PM batch sampling
- 8.2.1.1. Proportionality criteria for CVS
- 8.2.1.1.1. Proportional flows

For any pair of flow meters, the recorded sample and total flow rates or their 1 Hz means shall be used with the statistical calculations in Appendix 3 of Annex VII. The standard error of the estimate, *SEE*, of the sample flow rate versus the total flow rate shall be determined. For each test interval, it shall be demonstrated that *SEE* was less than or equal to 3,5 % of the mean sample flow rate.

- 8.2.1.1.2. Constant flows

For any pair of flow meters, the recorded sample and total flow rates or their 1 Hz means shall be used to demonstrate that each flow rate was constant within $\pm 2,5$ % of its respective mean or target flow rate. The following options may be used instead of recording the respective flow rate of each type of meter:

- (a) Critical-flow venturi option. For critical-flow venturis, the recorded venturi-inlet conditions or their 1 Hz means shall be used. It shall be demonstrated that the flow density at the venturi inlet was constant within $\pm 2,5$ % of the mean or

▼B

target density over each test interval. For a CVS critical-flow venturi, this may be demonstrated by showing that the absolute temperature at the venturi inlet was constant within $\pm 4\%$ of the mean or target absolute temperature over each test interval;

- (b) Positive-displacement pump option. The recorded pump-inlet conditions or their 1 Hz means shall be used. It shall be demonstrated that the flow density at the pump inlet was constant within $\pm 2,5\%$ of the mean or target density over each test interval. For a CVS pump, this may be demonstrated by showing that the absolute temperature at the pump inlet was constant within $\pm 2\%$ of the mean or target absolute temperature over each test interval.

8.2.1.1.3. Demonstration of proportional sampling

For any proportional batch sample such as a bag or PM filter, it shall be demonstrated that proportional sampling was maintained using one of the following, noting that up to 5% of the total number of data points may be omitted as outliers.

Using good engineering judgment, it shall be demonstrated with an engineering analysis that the proportional-flow control system inherently ensures proportional sampling under all circumstances expected during testing. For example, CFVs may be used for both sample flow and total flow if it is demonstrated that they always have the same inlet pressures and temperatures and that they always operate under critical-flow conditions.

Measured or calculated flows and/or tracer gas concentrations (e.g. CO₂) shall be used to determine the minimum dilution ratio for PM batch sampling over the test interval.

8.2.1.2. Partial flow dilution system validation

For the control of a partial flow dilution system to extract a proportional raw exhaust gas sample, a fast system response is required; this is identified by the promptness of the partial flow dilution system. The transformation time for the system shall be determined in accordance with the procedure set out in point 8.1.8.6.3.2. The actual control of the partial flow dilution system shall be based on the current measured conditions. If the combined transformation time of the exhaust gas flow measurement and the partial flow system is $\leq 0,3$ s, online control shall be used. If the transformation time exceeds 0,3 s, look-ahead control based on a pre-recorded test run shall be used. In this case, the combined rise time shall be ≤ 1 s and the combined delay time ≤ 10 s. The total system response shall be designed as to ensure a representative sample of the particulates, $q_{mp,i}$ (sample flow of exhaust gas into partial flow dilution system), proportional to the exhaust gas mass flow. To determine the proportionality, a regression analysis of $q_{mp,i}$ versus $q_{mew,i}$ (exhaust gas mass flow rate on wet basis) shall be conducted on a minimum 5 Hz data acquisition rate, and the following criteria shall be met:

- (a) The correlation coefficient r^2 of the linear regression between $q_{mp,i}$ and $q_{mew,i}$ shall not be less than 0,95;
- (b) The standard error of estimate of $q_{mp,i}$ on $q_{mew,i}$ shall not exceed 5% of q_{mp} maximum;
- (c) q_{mp} intercept of the regression line shall not exceed $\pm 2\%$ of q_{mp} maximum.

▼ B

Look-ahead control is required if the combined transformation times of the particulate system, $t_{50,P}$ and of the exhaust gas mass flow signal, $t_{50,F}$ are $> 0,3$ s. In this case, a pre-test shall be run and the exhaust gas mass flow signal of the pre-test be used for controlling the sample flow into the particulate system. A correct control of the partial dilution system is obtained, if the time trace of $q_{mew,pre}$ of the pre-test, which controls q_{mp} , is shifted by a 'look-ahead' time of $t_{50,P} + t_{50,F}$.

For establishing the correlation between $q_{mp,i}$ and $q_{mew,i}$ the data taken during the actual test shall be used, with $q_{mew,i}$ time aligned by $t_{50,F}$ relative to $q_{mp,i}$ (no contribution from $t_{50,P}$ to the time alignment). The time shift between q_{mew} and q_{mp} is the difference between their transformation times that were determined in point 8.1.8.6.3.2.

8.2.2. Gas analyzer range validation, drift validation and drift correction

8.2.2.1. Range validation

If an analyzer operated above 100 % of its range at any time during the test, the following steps shall be performed:

8.2.2.1.1. Batch sampling

For batch sampling, the sample shall be re-analyzed using the lowest analyzer range that results in a maximum instrument response below 100 %. The result shall be reported from the lowest range from which the analyzer operates below 100 % of its range for the entire test.

8.2.2.1.2. Continuous sampling

For continuous sampling, the entire test shall be repeated using the next higher analyzer range. If the analyzer again operates above 100 % of its range, the test shall be repeated using the next higher range. The test shall be continued to be repeated until the analyzer always operates at less than 100 % of its range for the entire test.

8.2.2.2. Drift validation and drift correction

If the drift is within ± 1 %, the data can be either accepted without any correction or accepted after correction. If the drift is greater than ± 1 %, two sets of brake specific emission results shall be calculated for each pollutant with a brake-specific limit value and for CO_2 , or the test shall be voided. One set shall be calculated using data before drift correction and another set of data calculated after correcting all the data for drift in accordance with point 2.6 of Annex VII and Appendix 1 of Annex VII. The comparison shall be made as a percentage of the uncorrected results. The difference between the uncorrected and the corrected brake-specific emission values shall be within ± 4 % of either the uncorrected brake-specific emission values or the emission limit value, whichever is greater. If not, the entire test is void.

8.2.3. PM sampling media (e.g. filters) preconditioning and tare weighing

Before an emission test, the following steps shall be taken to prepare PM sample filter media and equipment for PM measurements:

▼ B

- 8.2.3.1. Periodic verifications
- It shall be made sure that the balance and PM-stabilization environments meet the periodic verifications in point 8.1.12. The reference filter shall be weighed just before weighing test filters to establish an appropriate reference point (see section details of the procedure in point 8.1.12.1). The verification of the stability of the reference filters shall occur after the post-test stabilisation period, immediately before the post-test weighing.
- 8.2.3.2. Visual Inspection
- The unused sample filter media shall be visually inspected for defects, defective filters shall be discarded.
- 8.2.3.3. Grounding
- Electrically grounded tweezers or a grounding strap shall be used to handle PM filters as described in point 9.3.4.
- 8.2.3.4. Unused sample media
- Unused sample media shall be placed in one or more containers that are open to the PM-stabilization environment. If filters are used, they may be placed in the bottom half of a filter cassette.
- 8.2.3.5. Stabilization
- Sample media shall be stabilized in the PM-stabilization environment. An unused sample medium can be considered stabilized as long as it has been in the PM-stabilization environment for a minimum of 30 min, during which the PM-stabilization environment has been within the specifications of point 9.3.4. ► **M2** However, if a PM mass of 400 µg or more is expected, then the sample media shall be stabilised for at least 60 min. ◀
- 8.2.3.6. Weighing
- The sample media shall be weighed automatically or manually, as follows:
- (a) For automatic weighing, the automation system manufacturer's instructions shall be followed to prepare samples for weighing; this may include placing the samples in a special container;
 - (b) For manual weighing, good engineering judgment shall be used;
 - (c) Optionally, substitution weighing is permitted (see point 8.2.3.10);
 - (d) Once a filter is weighed it shall be returned to the Petri dish and covered.
- 8.2.3.7. Buoyancy correction
- The measured weight shall be corrected for buoyancy as described in point 8.1.13.2.
- 8.2.3.8. Repetition
- The filter mass measurements may be repeated to determine the average mass of the filter using good engineering judgement and to exclude outliers from the calculation of the average.

▼B

8.2.3.9. Tare-weighing

Unused filters that have been tare-weighed shall be loaded into clean filter cassettes and the loaded cassettes shall be placed in a covered or sealed container before they are taken to the test cell for sampling.

8.2.3.10. Substitution weighing

Substitution weighing is an option and, if used, involves measurement of a reference weight before and after each weighing of a PM sampling medium (e.g. filter). While substitution weighing requires more measurements, it corrects for a balance's zero-drift and it relies on balance linearity only over a small range. This is most appropriate when quantifying total PM masses that are less than 0,1 % of the sample medium's mass. However, it may not be appropriate when total PM masses exceed 1 % of the sample medium's mass. If substitution weighing is used, it shall be used for both pre-test and post-test weighing. The same substitution weight shall be used for both pre-test and post-test weighing. The mass of the substitution weight shall be corrected for buoyancy if the density of the substitution weight is less than 2,0 g/cm³. The following steps are an example of substitution weighing:

- (a) Electrically grounded tweezers or a grounding strap shall be used, as described in point 9.3.4.6;
- (b) A static neutralizer shall be used as described in point 9.3.4.6 to minimize static electric charge on any object before it is placed on the balance pan;
- (c) A substitution weight shall be selected that meets the specifications for calibration weights in point 9.5.2. The substitution weight shall also have the same density as the weight that is used to span the microbalance, and shall be similar in mass to an unused sample medium (e.g. filter). If filters are used, the weight's mass should be about (80 to 100) mg for typical 47 mm diameter filters;
- (d) The stable balance reading shall be recorded and then the calibration weight shall be removed;
- (e) An unused sampling medium (e.g. a new filter) shall be weighed, the stable balance reading recorded and the balance environment's dew point, ambient temperature, and atmospheric pressure recorded;
- (f) The calibration weight shall be reweighed and the stable balance reading recorded;
- (g) The arithmetic mean of the two calibration-weight readings that were recorded immediately before and after weighing the unused sample shall be calculated. That mean value shall be subtracted from the unused sample reading, then the true mass of the calibration weight as stated on the calibration-weight certificate shall be added. This result shall be recorded. This is the unused sample's tare weight without correcting for buoyancy;
- (h) These substitution-weighing steps shall be repeated for the remainder of the unused sample media;
- (i) The instructions given in points 8.2.3.7 to 8.2.3.9 shall be followed once weighing is completed.

▼B

8.2.4. Post-test PM sample conditioning and weighing

Used PM sample filters shall be placed into covered or sealed containers or the filter holders shall be closed, in order to protect the sample filters against ambient contamination. Thus protected, the loaded filters have to be returned to the PM-filter conditioning chamber or room. Then the PM sample filters shall be conditioned and weighed accordingly.

8.2.4.1. Periodic verification

It shall be assured that the weighing and PM-stabilization environments have met the periodic verifications in point 8.1.13.1. After testing is complete, the filters shall be returned to the weighing and PM-stabilisation environment. The weighing and PM-stabilisation environment shall meet the ambient conditions requirements in point 9.3.4.4, otherwise the test filters shall be left covered until proper conditions have been met.

8.2.4.2. Removal from sealed containers

In the PM-stabilization environment, the PM samples shall be removed from the sealed containers. Filters may be removed from their cassettes before or after stabilization. When a filter is removed from a cassette, the top half of the cassette shall be separated from the bottom half using a cassette separator designed for this purpose.

8.2.4.3. Electrical grounding

To handle PM samples, electrically grounded tweezers or a grounding strap shall be used, as described in point 9.3.4.5.

8.2.4.4. Visual inspection

The collected PM samples and the associated filter media shall be inspected visually. If the conditions of either the filter or the collected PM sample appear to have been compromised, or if the particulate matter contacts any surface other than the filter, the sample may not be used to determine particulate emissions. In the case of contact with another surface; the affected surface shall be cleaned before proceeding.

8.2.4.5. Stabilisation of PM samples

To stabilise PM samples, they shall be placed in one or more containers that are open to the PM-stabilization environment, which is described in point 9.3.4.3. A PM sample is stabilized as long as it has been in the PM-stabilization environment for one of the following durations, during which the stabilization environment has been within the specifications of point 9.3.4.3:

- (a) If it is expected that a filter's total surface concentration of PM will be greater than $0,353 \mu\text{g}/\text{mm}^2$, assuming a $400 \mu\text{g}$ loading on a 38 mm diameter filter stain area, the filter shall be exposed to the stabilization environment for at least 60 minutes before weighing;
- (b) If it is expected that a filter's total surface concentration of PM will be less than $0,353 \mu\text{g}/\text{mm}^2$, the filter shall be exposed to the stabilization environment for at least 30 minutes before weighing;
- (c) If a filter's total surface concentration of PM to be expected during the test is unknown, the filter shall be exposed to the stabilization environment for at least 60 minutes before weighing.

▼B

- 8.2.4.6. Determination of post-test filter mass
- The procedures in point 8.2.3 shall be repeated (points 8.2.3.6 through 8.2.3.9) to determine the post-test filter mass.
- 8.2.4.7. Total mass
- Each buoyancy-corrected filter tare mass shall be subtracted from its respective buoyancy-corrected post-test filter mass. The result is the total mass, m_{total} , which shall be used in emission calculations in Annex VII.
9. **Measurement equipment**
- 9.1. Engine dynamometer specification
- 9.1.1. Shaft work
- An engine dynamometer shall be used that has adequate characteristics to perform the applicable duty cycle including the ability to meet appropriate cycle validation criteria. The following dynamometers may be used:
- (a) Eddy-current or water-brake dynamometers;
 - (b) Alternating-current or direct-current motoring dynamometers;
 - (c) One or more dynamometers.
- 9.1.2. Transient (NRTC and LSI-NRTC) test cycles
- Load cell or in-line torque meter may be used for torque measurements.
- When using a load cell, the torque signal shall be transferred to the engine axis and the inertia of the dynamometer shall be considered. The actual engine torque is the torque read on the load cell plus the moment of inertia of the brake multiplied by the angular acceleration. The control system has to perform such a calculation in real time.
- 9.1.3. Engine accessories
- The work of engine accessories required to fuel, lubricate, or heat the engine, circulate liquid coolant to the engine, or to operate exhaust after-treatment systems shall be accounted for and they shall be installed in accordance with point 6.3.
- 9.1.4. Engine fixture and power transmission shaft system (category NRSh)
- Where necessary for the proper testing of an engine of category NRSh, the engine fixture for the test bench and power transmission shaft system for connection to the dynamometer rotating system specified by the manufacturer shall be used.
- 9.2. Dilution procedure (if applicable)
- 9.2.1. Diluent conditions and background concentrations
- Gaseous constituents may be measured raw or dilute whereas PM measurement generally requires dilution. Dilution may be accomplished by a full flow or partial flow dilution system. When dilution is applied then the exhaust gas may be diluted with ambient air, synthetic air, or nitrogen. For gaseous emissions measurement the diluent shall be at least 288 K (15 °C). For PM sampling the temperature of the diluent is specified in points 9.2.2 for CVS and 9.2.3 for PFD with varying dilution ratio. The flow capacity

▼ B

of the dilution system shall be large enough to completely eliminate water condensation in the dilution and sampling systems. De-humidifying the dilution air before entering the dilution system is permitted, if the air humidity is high. The dilution tunnel walls may be heated or insulated as well as the bulk stream tubing downstream of the tunnel to prevent the precipitation of water-containing constituents from a gas phase to a liquid phase ('aqueous condensation').

Before a diluent is mixed with exhaust gas, it may be preconditioned by increasing or decreasing its temperature or humidity. Constituents may be removed from the diluent to reduce their background concentrations. The following provisions apply to removing constituents or accounting for background concentrations:

- (a) Constituent concentrations in the diluent may be measured and compensated for background effects on test results. See Annex VII for calculations that compensate for background concentrations;
- (b) The following changes to the requirements of sections 7.2, 9.3 and 9.4 are permitted for measuring background gaseous or particulate pollutants:
 - (i) It shall not be required to use proportional sampling;
 - (ii) Unheated sampling systems may be used;
 - (iii) Continuous sampling may be used irrespective of the use of batch sampling for diluted emissions;
 - (iv) Batch sampling may be used irrespective of the use of continuous sampling for diluted emissions.
- (c) To account for background PM the following options are available:

▼ M2

- (i) For removing background PM, the diluent shall be filtered with high-efficiency particulate air (HEPA) filters that have an initial minimum collection efficiency specification of 99,97 % (see Article 1(19) for procedures related to HEPA-filtration efficiencies);

▼ B

- (ii) For correcting for background PM without HEPA filtration, the background PM shall not contribute more than 50 % of the net PM collected on the sample filter;
- (iii) Background correction of net PM with HEPA filtration is permitted without pressure restriction.

9.2.2. Full flow system

Full-flow dilution; constant-volume sampling (CVS). The full flow of raw exhaust gas is diluted in a dilution tunnel. Constant flow may be maintained by maintaining the temperature and pressure at the flow meter within the limits. For non-constant flow the flow shall be measured directly to allow for proportional sampling. The system shall be designed as follows (see Figure 6.6):

- (a) A tunnel with inside surfaces of stainless steel shall be used. The entire dilution tunnel shall be electrically grounded. Alternatively non-conductive materials may be used for engine categories neither subject to PM nor PN limits;

▼ B

- (b) The exhaust gas back-pressure shall not be artificially lowered by the dilution air inlet system. The static pressure at the location where raw exhaust gas is introduced into the tunnel shall be maintained within $\pm 1,2$ kPa of atmospheric pressure;
- (c) To support mixing the raw exhaust gas shall be introduced into the tunnel by directing it downstream along the centreline of the tunnel. A fraction of dilution air may be introduced radially from the tunnel's inner surface to minimize exhaust gas interaction with the tunnel walls;
- (d) Diluent. For PM sampling the temperature of the diluents (ambient air, synthetic air, or nitrogen as quoted in point 9.2.1) shall be maintained between 293 and 325 K (20 to 52 °C) in close proximity to the entrance into the dilution tunnel;
- (e) The Reynolds number, Re , shall be at least 4 000 for the diluted exhaust gas flow, where Re is based on the inside diameter of the dilution tunnel. Re is defined in Annex VII. Verification of adequate mixing shall be performed while traversing a sampling probe across the tunnel's diameter, vertically and horizontally. If the analyzer response indicates any deviation exceeding ± 2 % of the mean measured concentration, the CVS shall be operated at a higher flow rate or a mixing plate or orifice shall be installed to improve mixing;
- (f) Flow measurement preconditioning. The diluted exhaust gas may be conditioned before measuring its flow rate, as long as this conditioning takes place downstream of heated HC or PM sample probes, as follows:
 - (i) Flow straighteners, pulsation dampeners, or both of these may be used;
 - (ii) A filter may be used;
 - (iii) A heat exchanger may be used to control the temperature upstream of any flow meter but steps shall be taken to prevent aqueous condensation;
- (g) Aqueous condensation. Aqueous condensation is a function of humidity, pressure, temperature, and concentrations of other constituents such as sulphuric acid. These parameters vary as a function of engine intake-air humidity, dilution-air humidity, engine air-to-fuel ratio, and fuel composition — including the amount of hydrogen and sulphur in the fuel.

To ensure that a flow is measured that corresponds to a measured concentration, either aqueous condensation shall be prevented between the sample probe location and the flow meter inlet in the dilution tunnel or aqueous condensation shall be allowed to occur and humidity at the flow meter inlet measured. The dilution tunnel walls or bulk stream tubing downstream of the tunnel may be heated or insulated to prevent aqueous condensation. Aqueous condensation shall be prevented throughout the dilution tunnel. Certain exhaust gas components can be diluted or eliminated by the presence of moisture;

▼ M2

For PM sampling, the already proportional flow coming from CVS goes through secondary dilution (one or more) to achieve the requested overall dilution ratio as shown in Figure 6.7 and set out in point 9.2.3.2;

▼B

- (h) The minimum overall dilution ratio shall be within the range of 5:1 to 7:1 and at least 2:1 for the primary dilution stage based on the maximum engine exhaust gas flow rate during the test cycle or test interval;
- (i) The overall residence time in the system shall be between 0,5 and 5 seconds, as measured from the point of diluent introduction to the filter holder(s);
- (j) The residence time in the secondary dilution system, if present, shall be at least 0,5 seconds, as measured from the point of secondary diluent introduction to the filter holder(s).

To determine the mass of the particulates, a particulate sampling system, a particulate sampling filter, a gravimetric balance, and a temperature and humidity controlled weighing chamber, are required.

Figure 6.6

Examples of full-flow dilution sampling configurations

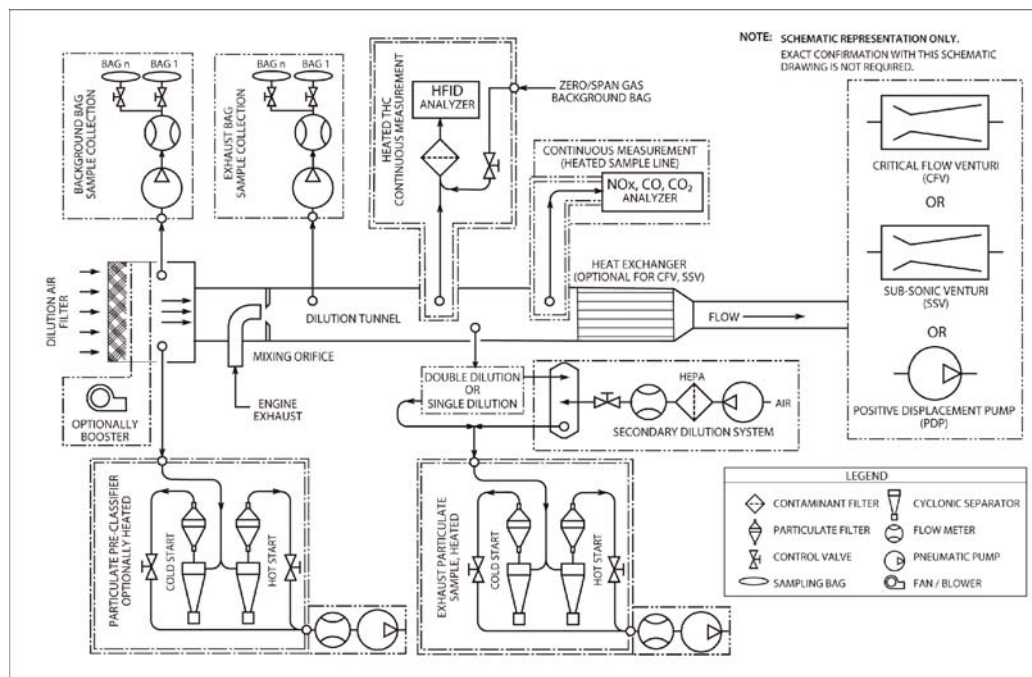

9.2.3. Partial flow dilution (PFD) system

9.2.3.1. Description of partial flow system

A schematic of a PFD system is shown in Figure 6.7. It is a general schematic showing principles of sample extraction, dilution and PM sampling. It is not meant to indicate that all the components described in the Figure are necessary for other possible sampling systems that satisfy the intent of sample collection. Other configurations which do not match these schematics are allowed under the condition that they serve the same purpose of sample collection, dilution, and PM sampling. ►M2 These need to satisfy other criteria such as in points 8.1.8.6 (periodic calibration) and 8.2.1.2 (validation) for varying dilution PFD, and point 8.1.4.5 as well as Table 6.5 (linearity verification) and point 8.1.8.5.7 (verification) for constant dilution PFD. ◀

▼ B

As shown in Figure 6.7, the raw exhaust gas or the primary diluted flow is transferred from the exhaust pipe EP or from CVS respectively to the dilution tunnel DT through the sampling probe SP and the transfer line TL. The total flow through the tunnel is adjusted with a flow controller and the sampling pump P of the particulate sampling system (PSS). For proportional raw exhaust gas sampling, the dilution air flow is controlled by the flow controller FC1, which may use q_{mew} (exhaust gas mass flow rate on wet basis) or q_{maw} (intake air mass flow rate on wet basis) and q_{mf} (fuel mass flow rate) as command signals, for the desired exhaust gas split. The sample flow into the dilution tunnel DT is the difference of the total flow and the dilution air flow. The dilution air flow rate is measured with the flow measurement device FM1, the total flow rate with the flow measurement device of the particulate sampling system. The dilution ratio is calculated from these two flow rates. For sampling with a constant dilution ratio of raw or diluted exhaust gas flow (e.g.: secondary dilution for PM sampling), the dilution air flow rate is usually constant and controlled by the flow controller FC1 or dilution air pump.

The dilution air (ambient air, synthetic air, or nitrogen) shall be filtered with a high-efficiency PM air (HEPA) filter.

Figure 6.7

Schematic of partial flow dilution system (total sampling type).

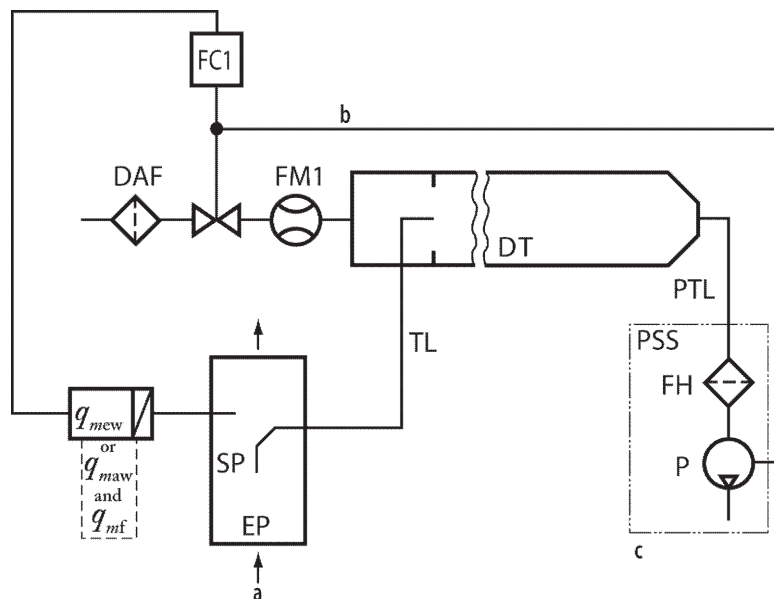

a = engine exhaust gas or primary diluted flow

b = optional

c = PM sampling

Components of Figure 6.7:

DAF: Dilution air filter

DT: Dilution tunnel or secondary dilution system

EP: Exhaust pipe or primary dilution system

▼ B

FC1:	Flow controller
FH:	Filter holder
FM1:	Flow measurement device measuring the dilution air flow rate
P:	Sampling pump
PSS:	PM sampling system
PTL:	PM transfer line
SP:	Raw or diluted exhaust gas sampling probe
TL:	Transfer line

Mass flow rates applicable only for proportional raw exhaust gas sampling PFD:

q_{mew} is the exhaust gas mass flow rate on wet basis

q_{maw} is the intake air mass flow rate on wet basis

q_{mf} is the fuel mass flow rate

9.2.3.2. Dilution

The temperature of the diluents (ambient air, synthetic air, or nitrogen as quoted in point 9.2.1) shall be maintained between 293 and 325 K (20 to 52 °C) in close proximity to the entrance into the dilution tunnel.

De-humidifying the dilution air before entering the dilution system is permitted. The partial flow dilution system has to be designed to extract a proportional raw exhaust gas sample from the engine exhaust gas stream, thus responding to excursions in the exhaust gas stream flow rate, and introduce dilution air to this sample to achieve a temperature at the test filter as prescribed by point 9.3.3.4.3. For this it is essential that the dilution ratio be determined such that the accuracy requirements of point 8.1.8.6.1 are fulfilled.

To ensure that a flow is measured that corresponds to a measured concentration, either aqueous condensation shall be prevented between the sample probe location and the flow meter inlet in the dilution tunnel or aqueous condensation shall be allowed to occur and humidity at the flow meter inlet measured. The PFD system may be heated or insulated to prevent aqueous condensation. Aqueous condensation shall be prevented throughout the dilution tunnel.

The minimum dilution ratio shall be within the range of 5:1 to 7:1 based on the maximum engine exhaust gas flow rate during the test cycle or test interval.

The residence time in the system shall be between 0,5 and 5 s, as measured from the point of diluent introduction to the filter holder(s).

To determine the mass of the particulates, a particulate sampling system, a particulate sampling filter, a gravimetric balance, and a temperature and humidity controlled weighing chamber, are required.

▼ B

9.2.3.3. Applicability

PFD may be used to extract a proportional raw exhaust gas sample for any batch or continuous PM and gaseous emission sampling over any transient (NRTC and LSI-NRTC) duty cycle, any discrete-mode NRSC or any RMC duty cycle.

▼ M2

The system may be used also for a previously diluted exhaust gas where, via a constant dilution-ratio, an already proportional flow is diluted (see Figure 6.7). This is the way of performing secondary dilution from a CVS tunnel to achieve the necessary overall dilution ratio for PM sampling.

▼ B

9.2.3.4. Calibration

The calibration of the PFD to extract a proportional raw exhaust gas sample is considered in point 8.1.8.6.

9.3. Sampling procedures

9.3.1. General sampling requirements

9.3.1.1. Probe design and construction

A probe is the first fitting in a sampling system. It protrudes into a raw or diluted exhaust gas stream to extract a sample, such that it's inside and outside surfaces are in contact with the exhaust gas. A sample is transported out of a probe into a transfer line.

Sample probes shall be made with inside surfaces of stainless steel or, for raw exhaust gas sampling, with any non-reactive material capable of withstanding raw exhaust gas temperatures. Sample probes shall be located where constituents are mixed to their mean sample concentration and where interference with other probes is minimised. It is recommended that all probes remain free from influences of boundary layers, wakes, and eddies — especially near the outlet of a raw-exhaust meter tailpipe where unintended dilution might occur. Purging or back-flushing of a probe shall not influence another probe during testing. A single probe to extract a sample of more than one constituent may be used as long as the probe meets all the specifications for each constituent.

9.3.1.1.1. Mixing chamber (category NRSh)

Where permitted by the manufacturer, a mixing chamber may be used when testing engines of category NRSh. The mixing chamber is an optional component of a raw gas sampling system and is located in the exhaust system between the silencer and the sample probe. The shape and dimensions of the mixing chamber and tubing before and after shall be such that it provides a well-mixed, homogeneous sample at the sample probe location and so that strong pulsations or resonances of the chamber influencing the emissions results are avoided.

9.3.1.2. Transfer lines

Transfer lines that transport an extracted sample from a probe to an analyzer, storage medium, or dilution system shall be minimized in length by locating analyzers, storage media, and dilution systems as close to the probes as practical. The number of bends in transfer lines shall be minimized and that the radius of any unavoidable bend shall be maximized.

▼ B

9.3.1.3. Sampling methods

For continuous and batch sampling, introduced in point 7.2, the following conditions apply:

- (a) When extracting from a constant flow rate, the sample shall also be carried out at a constant flow rate;
- (b) When extracting from a varying flow rate, the sample flow rate shall be varied in proportion to the varying flow rate;
- (c) Proportional sampling shall be validated as described in point 8.2.1.

9.3.2. Gas sampling

9.3.2.1. Sampling probes

Either single-port or multi-port probes are used for sampling gaseous emissions. The probes may be oriented in any direction relative to the raw or diluted exhaust gas flow. For some probes, the sample temperatures shall be controlled, as follows:

- (a) For probes that extract NO_x from diluted exhaust gas, the probe's wall temperature shall be controlled to prevent aqueous condensation;
- (b) For probes that extract hydrocarbons from the diluted exhaust gas, a probe wall temperature is recommended to be controlled approximately 191 °C to minimise contamination.

9.3.2.1.1. Mixing chamber (Category NRSh)

► **M2** When used in accordance with point 9.3.1.1.1, the internal volume of the mixing chamber shall not be less than ten times the individual cylinder swept volume of the engine under test. ◀ The mixing chamber shall be coupled as closely as possible to the engine silencer and shall have a minimum inner surface temperature of 452 K (179 °C). The manufacturer may specify the design of the mixing chamber.

9.3.2.2. Transfer lines

Transfer lines with inside surfaces of stainless steel, PTFE, Viton™, or any other material that has better properties for emission sampling shall be used. A non-reactive material capable of withstanding exhaust gas temperatures shall be used. In-line filters may be used if the filter and its housing meet the same temperature requirements as the transfer lines, as follows:

- (a) For NO_x transfer lines upstream of either an NO₂-to-NO converter that meets the specifications set out in point 8.1.11.5 or a chiller that meets the specifications set out in point 8.1.11.4 a sample temperature that prevents aqueous condensation shall be maintained;

▼ M2

- (b) For THC transfer lines a wall temperature tolerance throughout the entire line of (464 ± 11) K [(191 ± 11) °C] shall be maintained. If sampled from raw exhaust gas, an unheated, insulated transfer line may be connected directly to a probe. The length and insulation of the transfer line shall be designed to cool the

▼ M2

highest expected raw exhaust gas temperature to no lower than 191 °C, as measured at the transfer line outlet. For dilute sampling a transition zone between the probe and transfer line of up to 0,92 m in length is allowed to transition the wall temperature to (464 ± 11) K [(191 ± 11) °C].

▼ B

9.3.2.3. Sample-conditioning components

9.3.2.3.1. Sample dryers

9.3.2.3.1.1. Requirements

Sample dryers may be used for removing moisture from the sample in order to decrease the effect of water on gaseous emissions measurement. Sample dryers shall meet the requirements set out in point 9.3.2.3.1.1 and in point 9.3.2.3.1.2. The moisture content 0,8 volume % is used in equation (7-13).

▼ M2

For the highest expected water vapour concentration H_m , the water removal technique shall maintain humidity at ≤ 5 g water/kg dry air (or about 0,8 volume % H₂O), which is 100 % relative humidity at 277,1 K (3,9 °C) and 101,3 kPa. This humidity specification is equivalent to about 25 % relative humidity at 298 K (25 °C) and 101,3 kPa. This may be demonstrated by either:

- (a) measuring the temperature at the outlet of the sample dryer; or
- (b) measuring humidity at a point just upstream of the CLD; or
- (c) performing the verification procedure in point 8.1.12.

▼ B

9.3.2.3.1.2. Type of sample dryers allowed and procedure to estimate moisture content after the dryer

Either type of sample dryer described in this point may be used.

- (a) If an osmotic-membrane dryer upstream of any gaseous analyzer or storage medium is used, it shall meet the temperature specifications set out in point 9.3.2.2. The dew point, T_{dew} , and absolute pressure, p_{total} , downstream of an osmotic-membrane dryer shall be monitored. The amount of water shall be calculated as specified in Annex VII by using continuously recorded values of T_{dew} and p_{total} or their peak values observed during a test or their alarm set points. Lacking a direct measurement, the nominal p_{total} is given by the dryer's lowest absolute pressure expected during testing.
- (b) A thermal chiller upstream of a THC measurement system for compression-ignition engines may not be used. If a thermal chiller upstream of an NO₂-to-NO converter or in a sampling system without an NO₂-to-NO converter is used, the chiller shall meet the NO₂ loss-performance check specified in point 8.1.11.4. The dew point, T_{dew} , and absolute pressure, p_{total} , downstream of a thermal chiller shall be monitored. The amount of water shall be calculated as specified in Annex VII by using continuously recorded values of T_{dew} and p_{total} or their peak values observed during a test or their alarm set points. Lacking a direct measurement, the nominal p_{total} is given by the thermal chiller's lowest absolute pressure expected during testing. If it is valid to assume the degree of saturation in the

▼ B

thermal chiller, T_{dew} based on the known chiller efficiency and continuous monitoring of chiller temperature, T_{chiller} may be calculated. If values of T_{chiller} are not continuously recorded, its peak value observed during a test, or its alarm set point, may be used as a constant value to determine a constant amount of water in accordance with Annex VII. If it is valid to assume that T_{chiller} is equal to T_{dew} , T_{chiller} may be used in lieu of T_{dew} in accordance with Annex VII. If it is valid to assume a constant temperature offset between T_{chiller} and T_{dew} , due to a known and fixed amount of sample reheat between the chiller outlet and the temperature measurement location, this assumed temperature offset value may be factored in into emission calculations. The validity of any assumptions allowed by this point shall be shown by engineering analysis or by data.

9.3.2.3.2. Sample pumps

Sample pumps upstream of an analyzer or storage medium for any gas shall be used. Sample pumps with inside surfaces of stainless steel, PTFE, or any other material having better properties for emission sampling shall be used. For some sample pumps, temperatures shall be controlled, as follows:

- (a) If a NO_x sample pump upstream of either an NO_2 -to- NO converter that meets the requirements set out in point 8.1.11.5 or a chiller that meets the requirements set out in point 8.1.11.4 is used, it shall be heated to prevent aqueous condensation;
- (b) If a THC sample pump upstream of a THC analyzer or storage medium is used, its inner surfaces shall be heated to a tolerance of $464 \pm 11 \text{ K}$ (191 ± 11) °C.

9.3.2.3.3. Ammonia scrubbers

Ammonia scrubbers may be used for any or all gaseous sampling systems to prevent NH_3 interference, poisoning of NO_2 -to- NO converter, and deposits in the sampling system or analysers. Installation of the ammonia scrubber shall follow the manufacturer's recommendations.

9.3.2.4. Sample storage media

In the case of bag sampling, gas volumes shall be stored in sufficiently clean containers that minimally off-gas or allow permeation of gases. Good engineering judgment shall be used to determine acceptable thresholds of storage media cleanliness and permeation. To clean a container, it may be repeatedly purged and evacuated and may be heated. A flexible container (such as a bag) within a temperature-controlled environment, or a temperature controlled rigid container that is initially evacuated or has a volume that can be displaced, such as a piston and cylinder arrangement, shall be used. Containers meeting the specifications in the following Table 6.6 shall be used.

▼B

Table 6.6

Gaseous Batch Sampling Container Materials

CO, CO ₂ , O ₂ , CH ₄ , C ₂ H ₆ , C ₃ H ₈ , NO, NO ₂ ⁽¹⁾	polyvinyl fluoride (PVF) ⁽²⁾ for example Tedlar™, polyvinylidene fluoride ⁽²⁾ for example Kynar™, polytetrafluoroethylene ⁽³⁾ for example Teflon™, or stainless steel ⁽²⁾
HC	polytetrafluoroethylene ⁽⁴⁾ or stainless steel ⁽⁴⁾

⁽¹⁾ As long as aqueous condensation in storage container is prevented.

⁽²⁾ Up to 313 K (40 °C).

⁽³⁾ Up to 475 K (202 °C).

⁽⁴⁾ At 464 ± 11 K (191 ± 11 °C).

9.3.3. PM sampling

9.3.3.1. Sampling probes

PM probes with a single opening at the end shall be used. PM probes shall be oriented to face directly upstream.

The PM probe may be shielded with a hat that conforms with the requirements in Figure 6.8. In this case the pre-classifier described in point 9.3.3.3 shall not be used.

Figure 6.8

Scheme of a sampling probe with a hat-shaped pre-classifier

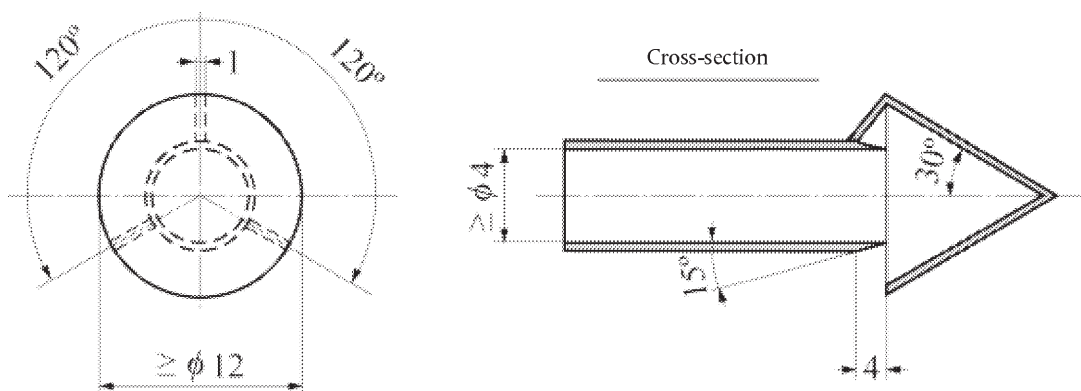

9.3.3.2. Transfer lines

Insulated or heated transfer lines or a heated enclosure are recommended to minimize temperature differences between transfer lines and exhaust gas constituents. Transfer lines that are inert with respect to PM and are electrically conductive on the inside surfaces shall be used. It is recommended using PM transfer lines made of stainless steel; any material other than stainless steel will be required to meet the same sampling performance as stainless steel. The inside surface of PM transfer lines shall be electrically grounded.

9.3.3.3. Pre-classifier

The use of a PM pre-classifier to remove large-diameter particles is permitted that is installed in the dilution system directly before the filter holder. Only one pre-classifier is permitted. If a hat shaped probe is used (see Figure 6.8), the use of a pre-classifier is prohibited.

▼ B

The PM pre-classifier may be either an inertial impactor or a cyclonic separator. It shall be constructed of stainless steel. The pre-classifier shall be rated to remove at least 50 % of PM at an aerodynamic diameter of 10 µm and no more than 1 % of PM at an aerodynamic diameter of 1 µm over the range of flow rates for which it is used. The pre-classifier outlet shall be configured with a means of bypassing any PM sample filter so that the pre-classifier flow can be stabilized before starting a test. PM sample filter shall be located within 75 cm downstream of the pre-classifier's exit.

9.3.3.4. Sample filter

The diluted exhaust gas shall be sampled by a filter that meets the requirements set out in points 9.3.3.4.1 to 9.3.3.4.4 during the test sequence.

9.3.3.4.1. Filter specification

All filter types shall have a collection efficiency of at least 99,7 %. The sample filter manufacturer's measurements reflected in their product ratings may be used to show this requirement. The filter material shall be either:

(a) Fluorocarbon (PTFE) coated glass fibre; or

(b) Fluorocarbon (PTFE) membrane.

If the expected net PM mass on the filter exceeds 400 µg, a filter with a minimum initial collection efficiency of 98 % may be used.

9.3.3.4.2. Filter size

The nominal filter size shall be 46,50 mm ± 0,6 mm diameter (at least 37 mm stain diameter). Larger diameter filters may be used with prior agreement of the approval authority. Proportionality between filter and stain area is recommended.

9.3.3.4.3. Dilution and temperature control of PM samples

PM samples shall be diluted at least once upstream of transfer lines in case of a CVS system and downstream in case of PFD system (see point 9.3.3.2 relating to transfer lines). ► **M2** Sample temperature shall be controlled to a 320 ± 5 K (47 ± 5 °C) tolerance, as measured anywhere within 200 mm upstream or 200 mm downstream of the PM filter media. ◀ The PM sample is intended to be heated or cooled primarily by dilution conditions as specified in point 9.2.1(a).

9.3.3.4.4. Filter face velocity

A filter face velocity shall be between 0,90 and 1,00 m/s with less than 5 % of the recorded flow values exceeding this range. If the total PM mass exceeds 400 µg, the filter face velocity may be reduced. The face velocity shall be measured as the volumetric flow rate of the sample at the pressure upstream of the filter and temperature of the filter face, divided by the filter's exposed area. The exhaust system stack or CVS tunnel pressure shall be used for the upstream pressure if the pressure drop through the PM sampler up to the filter is less than 2 kPa.

▼B

9.3.3.4.5. Filter holder

To minimize turbulent deposition and to deposit PM evenly on a filter, a 12,5° (from centre) divergent cone angle to transition from the transfer-line inside diameter to the exposed diameter of the filter face shall be used. Stainless steel for this transition shall be used.

9.3.4. PM-stabilization and weighing environments for gravimetric analysis

9.3.4.1. Environment for gravimetric analysis

This section describes the two environments required to stabilize and weigh PM for gravimetric analysis: the PM stabilization environment, where filters are stored before weighing; and the weighing environment, where the balance is located. The two environments may share a common space.

Both the stabilization and the weighing environments shall be kept free of ambient contaminants, such as dust, aerosols, or semi-volatile material that could contaminate PM samples.

9.3.4.2. Cleanliness

The cleanliness of the PM-stabilization environment using reference filters shall be verified, as described in point 8.1.12.1.4.

9.3.4.3. Temperature of the chamber

The temperature of the chamber (or room) in which the particulate filters are conditioned and weighed shall be maintained to within 295 ± 1 K ($22 \text{ °C} \pm 1 \text{ °C}$) during all filter conditioning and weighing. The humidity shall be maintained to a dew point of $282,5 \pm 1$ K ($9,5 \text{ °C} \pm 1 \text{ °C}$) and a relative humidity of $45 \% \pm 8 \%$. If the stabilization and weighing environments are separate, the stabilization environment shall be maintained at a tolerance of 295 ± 3 K ($22 \text{ °C} \pm 3 \text{ °C}$).

9.3.4.4. Verification of ambient conditions

When using measurement instruments that meet the specifications in point 9.4 the following ambient conditions shall be verified:

- (a) Dew point and ambient temperature shall be recorded. These values shall be used to determine if the stabilization and weighing environments have remained within the tolerances specified in point 9.3.4.3 for at least 60 min before weighing filters;
- (b) Atmospheric pressure shall be continuously recorded within the weighing environment. An acceptable alternative is to use a barometer that measures atmospheric pressure outside the weighing environment, as long as it can be ensured that the atmospheric pressure at the balance is always at the balance within ± 100 Pa of the shared atmospheric pressure. A means to record the most recent atmospheric pressure shall be provided when each PM sample is weighed. ► **M2** This value shall be used to calculate the PM sample filter buoyancy correction in point 8.1.13.2. ◀

9.3.4.5. Installation of balance

The balance shall be installed as follows:

- (a) Installed on a vibration-isolation platform to isolate it from external noise and vibration;

▼B

- (b) Shielded from convective airflow with a static-dissipating draft shield that is electrically grounded.

9.3.4.6. Static electric charge

Static electric charge shall be minimized in the balance environment, as follows:

- (a) The balance is electrically grounded;
- (b) Stainless steel tweezers shall be used if PM samples shall be handled manually;
- (c) Tweezers shall be grounded with a grounding strap, or a grounding strap shall be provided for the operator such that the grounding strap shares a common ground with the balance;
- (d) A static-electricity neutralizer shall be provided that is electrically grounded in common with the balance to remove static charge from PM samples.

9.4. Measurement instruments

9.4.1. Introduction

9.4.1.1. Scope

This point specifies measurement instruments and associated system requirements related to emission testing. This includes laboratory instruments for measuring engine parameters, ambient conditions, flow-related parameters, and emission concentrations (raw or diluted).

9.4.1.2. Instrument types

Any instrument mentioned in this Regulation shall be used as described in the Regulation itself (see Table 6.5 for measurement quantities provided by these instruments). Whenever an instrument mentioned in this Regulation is used in a way that is not specified, or another instrument is used in its place, the requirements for equivalency provisions shall apply as specified in point 5.1.1. ►**M2** Where more than one instrument for a particular measurement is specified, one of them will be identified by the approval authority upon application as the reference for showing that an alternative procedure is equivalent to the specified procedure. ◀

9.4.1.3. Redundant systems

►**M2** Data from multiple instruments to calculate test results for a single test may be used for all measurement instruments described in this point, with prior approval of the approval authority. ◀ Results from all measurements shall be recorded and the raw data shall be retained. This requirement applies whether or not the measurements are actually used in the calculations.

9.4.2. Data recording and control

The test system shall be able to update data, record data and control systems related to operator demand, the dynamometer, sampling equipment, and measurement instruments. Data acquisition and control systems shall be used that can record at the specified minimum frequencies, as shown in Table 6.7 (this Table does not apply to discrete-mode NRSC testing).



Table 6.7

Data recording and control minimum frequencies

Applicable Test Protocol Section	Measured Values	Minimum Command and Control Frequency	Minimum Recording Frequency
7.6	Speed and torque during an engine step-map	1 Hz	1 mean value per step
7.6	Speed and torque during an engine sweep-map	5 Hz	1 Hz means
7.8.3	Transient (NRTC and LSI-NRTC) duty cycle reference and feedback speeds and torques	5 Hz	1 Hz means
7.8.2	Discrete-mode NRSC and RMC duty cycle reference and feedback speeds and torques	1 Hz	1 Hz
7.3	Continuous concentrations of raw analyzers	N/A	1 Hz
7.3	Continuous concentrations of dilute analyzers	N/A	1 Hz
7.3	Batch concentrations of raw or dilute analyzers	N/A	1 mean value per test interval
7.6 8.2.1	Diluted exhaust gas flow rate from a CVS with a heat exchanger upstream of the flow measurement	N/A	1 Hz
7.6 8.2.1	Diluted exhaust gas flow rate from a CVS without a heat exchanger upstream of the flow measurement	5 Hz	1 Hz means
7.6 8.2.1	Intake-air or exhaust gas flow rate (for raw transient measurement)	N/A	1 Hz means
7.6 8.2.1	Dilution air if actively controlled	5 Hz	1 Hz means
7.6 8.2.1	Sample flow from a CVS with a heat exchanger	1 Hz	1 Hz
7.6 8.2.1	Sample flow from a CVS without a heat exchanger	5 Hz	1 Hz mean

9.4.3. Performance specifications for measurement instruments

9.4.3.1. Overview

The test system as a whole shall meet all the applicable calibrations, verifications, and test-validation criteria specified in point 8.1, including the requirements of the linearity check of points 8.1.4 and 8.2. Instruments shall meet the specifications in Table 6.7 for all ranges to be used for testing. Furthermore, any documentation received from instrument manufacturers showing that instruments meet the specifications in Table 6.7 shall be kept.

▼B

9.4.3.2. Component requirements

Table 6.8 shows the specifications of transducers of torque, speed, and pressure, sensors of temperature and dew point, and other instruments. The overall system for measuring the given physical and/or chemical quantity shall meet the linearity verification in point 8.1.4. For gaseous emissions measurements, analyzers may be used, that have compensation algorithms that are functions of other measured gaseous components, and of the fuel properties for the specific engine test. Any compensation algorithm shall only provide offset compensation without affecting any gain (that is no bias).

Table 6.8

Recommended performance specifications for measurement instruments

Measurement Instrument	Measured quantity symbol	Complete System Rise time	Recording update frequency	Accuracy (°)	Repeatability (°)
Engine speed transducer	n	1 s	1 Hz means	2,0 % of pt. or 0,5 % of max	1,0 % of pt. or 0,25 % of max
Engine torque transducer	T	1 s	1 Hz means	2,0 % of pt. or 1,0 % of max	1,0 % of pt. or 0,5 % of max
Fuel flow meter (Fuel totalizer)		5 s (N/A)	1 Hz (N/A)	2,0 % of pt. or 1,5 % of max	1,0 % of pt. or 0,75 % of max
Total diluted exhaust gas meter (CVS) (With heat exchanger before meter)		1 s (5 s)	1 Hz means (1 Hz)	2,0 % of pt. or 1,5 % of max	1,0 % of pt. or 0,75 % of max
Dilution air, inlet air, exhaust gas, and sample flow meters		1 s	1 Hz means of 5 Hz samples	2,5 % of pt. or 1,5 % of max	1,25 % of pt. or 0,75 % of max
Continuous gas analyzer raw	x	5 s	2 Hz	2,0 % of pt. or 2,0 % of meas.	1,0 % of pt. or 1,0 % of meas.
Continuous gas analyzer dilute	x	5 s	1 Hz	2,0 % of pt. or 2,0 % of meas.	1,0 % of pt. or 1,0 % of meas.
Continuous gas analyzer	x	5 s	1 Hz	2,0 % of pt. or 2,0 % of meas.	1,0 % of pt. or 1,0 % of meas.
Batch gas analyzer	x	N/A	N/A	2,0 % of pt. or 2,0 % of meas.	1,0 % of pt. or 1,0 % of meas.

▼ B

Measurement Instrument	Measured quantity symbol	Complete System Rise time	Recording update frequency	Accuracy ^(a)	Repeatability ^(a)
Gravimetric PM balance	m_{PM}	N/A	N/A	See 9.4.11	0,5 µg
Inertial PM balance	m_{PM}	5 s	1 Hz	2,0 % of pt. or 2,0 % of meas.	1,0 % of pt. or 1,0 % of meas.

^(a) Accuracy and repeatability are all determined with the same collected data, as described in point 9.4.3, and based on absolute values. 'pt.' refers to the overall mean value expected at the emission limit; 'max.' refers to the peak value expected at the emission limit over the duty cycle, not the maximum of the instrument's range; 'meas.' refers to the actual mean measured over the duty cycle.

9.4.4. Measurement of engine parameters & ambient conditions

9.4.4.1. Speed and torque sensors

9.4.4.1.1. Application

Measurement instruments for work inputs and outputs during engine operation shall meet the specifications in this point. Sensors, transducers, and meters meeting the specifications in Table 6.8 are recommended. Overall systems for measuring work inputs and outputs shall meet the linearity verifications in point 8.1.4.

9.4.4.1.2. Shaft work

Work and power shall be calculated from outputs of speed and torque transducers according to point 9.4.4.1. Overall systems for measuring speed and torque shall meet the calibration and verifications in points 8.1.7 and 8.1.4.

Torque induced by the inertia of accelerating and decelerating components connected to the flywheel, such as the drive shaft and dynamometer rotor, shall be compensated for as needed, based on good engineering judgment.

9.4.4.2. Pressure transducers, temperature sensors, and dew point sensors

Overall systems for measuring pressure, temperature, and dew point shall meet the calibration in point 8.1.7.

Pressure transducers shall be located in a temperature-controlled environment, or they shall compensate for temperature changes over their expected operating range. Transducer materials shall be compatible with the fluid being measured.

9.4.5. Flow-related measurements

For any type of flow meter (of fuel, intake-air, raw exhaust gas, diluted exhaust gas, sample), the flow shall be conditioned as needed to prevent wakes, eddies, circulating flows, or flow pulsations from affecting the accuracy or repeatability of the meter. For some meters, this may be accomplished by using a sufficient length of straight tubing (such as a length equal to at least 10 pipe diameters) or by using specially designed tubing bends, straightening fins, orifice plates (or pneumatic pulsation dampeners for the fuel flow meter) to establish a steady and predictable velocity profile upstream of the meter.

▼ B

9.4.5.1. Fuel flow meter

Overall system for measuring fuel flow shall meet the calibration in point 8.1.8.1. In any fuel flow measurement it shall be accounted for any fuel that bypasses the engine or returns from the engine to the fuel storage tank.

9.4.5.2. Intake-air flow meter

Overall system for measuring intake-air flow shall meet the calibration in point 8.1.8.2.

9.4.5.3. Raw exhaust flow meter

9.4.5.3.1. Component requirements

The overall system for measuring raw exhaust gas flow shall meet the linearity requirements in point 8.1.4. Any raw-exhaust meter shall be designed to appropriately compensate for changes in the raw exhaust gas' thermodynamic, fluid, and compositional states.

9.4.5.3.2. Flow meter response time

► **M2** For the purpose of controlling of a partial flow dilution system to extract a proportional raw exhaust gas sample, a flow meter response time faster than indicated in Table 6.8 is required. ◀ For partial flow dilution systems with online control, the flow meter response time shall meet the specifications of point 8.2.1.2.

9.4.5.3.3. Exhaust gas cooling

This point does not apply to cooling of the exhaust gas due to the design of the engine, including, but not limited to, water-cooled exhaust manifolds or turbochargers.

Exhaust gas cooling upstream of the flow meter is permitted with the following restrictions:

- (a) PM shall not be sampled downstream of the cooling;
- (b) If cooling causes exhaust gas temperatures above 475 K (202 °C) to decrease to below 453 K (180 °C), HC shall not be sampled downstream of the cooling;
- (c) If cooling causes aqueous condensation, NO_x shall not be sampled downstream of the cooling unless the cooler meets the performance verification in point 8.1.11.4;
- (d) If cooling causes aqueous condensation before the flow reaches a flow meter, dew point T_{dew} and pressure p_{total} shall be measured at the flow meter inlet. These values shall be used in emission calculations in accordance with Annex VII.

9.4.5.4. Dilution air and diluted exhaust flow meters

9.4.5.4.1. Application

Instantaneous diluted exhaust gas flow rates or total diluted exhaust gas flow over a test interval shall be determined by using a diluted exhaust flow meter. Raw exhaust gas flow rates or total raw exhaust gas flow over a test interval may be calculated from the difference between a diluted exhaust flow meter and a dilution air meter.

▼B

9.4.5.4.2. Component requirements

The overall system for measuring diluted exhaust gas flow shall meet the calibration and verifications in points 8.1.8.4 and 8.1.8.5. The following meters may be used:

- (a) For constant-volume sampling (CVS) of the total flow of diluted exhaust gas, a critical-flow venturi (CFV) or multiple critical-flow venturis arranged in parallel, a positive-displacement pump (PDP), a subsonic venturi (SSV), or an ultrasonic flow meter (UFM) may be used. Combined with an upstream heat exchanger, either a CFV or a PDP will also function as a passive flow controller by keeping the diluted exhaust gas temperature constant in a CVS system;
- (b) For the Partial Flow Dilution (PFD) system the combination of any flow meter with any active flow control system to maintain proportional sampling of exhaust gas constituents may be used. The total flow of diluted exhaust gas, or one or more sample flows, or a combination of these flow controls may be controlled to maintain proportional sampling.

For any other dilution system, a laminar flow element, an ultrasonic flow meter, a subsonic venturi, a critical-flow venturi or multiple critical-flow venturis arranged in parallel, a positive-displacement meter, a thermal-mass meter, an averaging Pitot tube, or a hot-wire anemometer may be used.

9.4.5.4.3. Exhaust gas cooling

Diluted exhaust gas upstream of a dilute flow meter may be cooled, as long as all the following provisions are observed:

- (a) PM shall not be sampled downstream of the cooling;
- (b) If cooling causes exhaust gas temperatures above 475 K (202 °C) to decrease to below 453 K (180 °C), HC shall not be sampled downstream of the cooling;
- (c) If cooling causes aqueous condensation, NO_x shall not be sampled downstream of the cooling unless the cooler meets the performance verification in point 8.1.11.4;
- (d) If cooling causes aqueous condensation before the flow reaches a flow meter, dew point, T_{dew} and pressure p_{total} shall be measured at the flow meter inlet. These values shall be used in emission calculations in accordance with Annex VII.

9.4.5.5. Sample flow meter for batch sampling

A sample flow meter shall be used to determine sample flow rates or total flow sampled into a batch sampling system over a test interval. The difference between two flow meters may be used to calculate sample flow into a dilution tunnel e.g. for partial flow dilution PM measurement and secondary dilution flow PM measurement. Specifications for differential flow measurement to extract a proportional raw exhaust gas sample is set out in point 8.1.8.6.1 and the calibration of differential flow measurement is given in point 8.1.8.6.2.

Overall system for the sample flow meter shall meet the calibration requirements set out in point 8.1.8.

▼ B

9.4.5.6. Gas divider

A gas divider may be used to blend calibration gases.

A gas divider shall be used that blends gases to the specifications of point 9.5.1 and to the concentrations expected during testing. Critical-flow gas dividers, capillary-tube gas dividers, or thermal-mass-meter gas dividers may be used. Viscosity corrections shall be applied as necessary (if not done by gas divider internal software) to appropriately ensure correct gas division. The gas-divider system shall meet the linearity verification set out in point 8.1.4.5. Optionally, the blending device may be checked with an instrument which by nature is linear, e.g. using NO gas with a CLD. The span value of the instrument shall be adjusted with the span gas directly connected to the instrument. The gas divider shall be checked at the settings used and the nominal value shall be compared to the measured concentration of the instrument.

9.4.6. CO and CO₂ measurements

A Non-dispersive infrared (NDIR) analyzer shall be used to measure CO and CO₂ concentrations in raw or diluted exhaust gas for either batch or continuous sampling.

▼ M2

The NDIR-based system shall meet the calibration and verifications set out in point 8.1.9.1 or 8.1.9.2, as applicable.

▼ B

9.4.7. Hydrocarbon measurements

9.4.7.1. Flame-ionization detector

9.4.7.1.1. Application

A heated flame-ionization detector (HFID) analyzer shall be used to measure hydrocarbon concentrations in raw or diluted exhaust gas for either batch or continuous sampling. Hydrocarbon concentrations shall be determined on a carbon number basis of one, C₁. Heated FID analyzers shall maintain all surfaces that are exposed to emissions at a temperature of 464 ± 11 K (191 ± 11 °C). Optionally, for NG and LPG fuelled and SI engines, the hydrocarbon analyzer may be of the non-heated flame ionization detector (FID) type.

9.4.7.1.2. Component requirements

The FID-based system for measuring THC shall meet all of the verifications for hydrocarbon measurement in point 8.1.10.

9.4.7.1.3. FID fuel and burner air

FID fuel and burner air shall meet the specifications of point 9.5.1. The FID fuel and burner air shall not mix before entering the FID analyzer to ensure that the FID analyzer operates with a diffusion flame and not a premixed flame.

9.4.7.1.4. Reserved

9.4.7.1.5. Reserved

9.4.7.2. Reserved

9.4.8. NO_x measurements

▼B

Two measurement instruments are specified for NO_x measurement and either instrument may be used provided it meets the criteria specified in point 9.4.8.1 or 9.4.8.2, respectively. The chemiluminescent detector shall be used as the reference procedure for comparison with any proposed alternate measurement procedure under point 5.1.1.

9.4.8.1. Chemiluminescent detector

9.4.8.1.1. Application

A chemiluminescent detector (CLD) coupled with an NO₂-to-NO converter is used to measure NO_x concentration in raw or diluted exhaust gas for batch or continuous sampling.

9.4.8.1.2. Component requirements

The CLD-based system shall meet the quench verification set out in point 8.1.11.1. A heated or unheated CLD may be used, and a CLD that operates at atmospheric pressure or under a vacuum may be used.

9.4.8.1.3. NO₂-to-NO converter

An internal or external NO₂-to-NO converter that meets the verification in point 8.1.11.5 shall be placed upstream of the CLD, while the converter shall be configured with a bypass to facilitate this verification.

9.4.8.1.4. Humidity effects

All CLD temperatures shall be maintained to prevent aqueous condensation. To remove humidity from a sample upstream of a CLD, one of the following configurations shall be used:

(a) A CLD connected downstream of any dryer or chiller that is downstream of an NO₂-to-NO converter that meets the verification set out in point 8.1.11.5;

(b) A CLD connected downstream of any dryer or thermal chiller that meets the verification set out in point 8.1.11.4.

9.4.8.1.5. Response time

A heated CLD may be used to improve CLD response time.

9.4.8.2. Non-dispersive ultraviolet analyzer

9.4.8.2.1. Application

A non-dispersive ultraviolet (NDUV) analyzer is used to measure NO_x concentration in raw or diluted exhaust gas for batch or continuous sampling.

9.4.8.2.2. Component requirements

The NDUV-based system shall meet the verifications set out in point 8.1.11.3.

9.4.8.2.3. NO₂-to-NO converter

If the NDUV analyzer measures only NO, an internal or external NO₂-to-NO converter that meets the verification set out in point 8.1.11.5 shall be placed upstream of the NDUV analyzer. The converter shall be configured with a bypass to facilitate this verification.

▼B

9.4.8.2.4. Humidity effects

The NDUV temperature shall be maintained to prevent aqueous condensation, unless one of the following configurations is used:

(a) An NDUV shall be connected downstream of any dryer or chiller that is downstream of an NO₂-to-NO converter that meets the verification in point 8.1.11.5;

(b) An NDUV shall be connected downstream of any dryer or thermal chiller that meets the verification in point 8.1.11.4.

9.4.9. O₂ measurements

A paramagnetic detection (PMD) or magneto pneumatic detection (MPD) analyzer shall be used to measure O₂ concentration in raw or diluted exhaust gas for batch or continuous sampling.

9.4.10. Air-to-fuel ratio measurements

A Zirconia (ZrO₂) analyser may be used to measure air-to-fuel ratio in raw exhaust gas for continuous sampling. O₂ measurements with intake air or fuel flow measurements may be used to calculate exhaust gas flow rate in accordance with Annex VII.

9.4.11. PM measurements with gravimetric balance

A balance shall be used to weigh net PM collected on sample filter media.

The minimum requirement on the balance resolution shall be equal or lower than the repeatability of 0,5 microgram recommended in Table 6.8. If the balance uses internal calibration weights for routine spanning and linearity verifications, the calibration weights shall meet the specifications in point 9.5.2.

The balance shall be configured for optimum settling time and stability at its location.

9.4.12. Ammonia (NH₃) measurements**▼M2**

A FTIR (Fourier transform infrared) analyser, NDUV or laser infrared analyser may be used in accordance with Appendix 4.

▼B

9.5. Analytical gases and mass standards

9.5.1. Analytical gases

Analytical gases shall meet the accuracy and purity specifications of this section.

9.5.1.1. Gas specifications

The following gas specifications shall be considered:

(a) Purified gases shall be used to blend with calibration gases and to adjust measurement instruments so as to obtain a zero response to a zero calibration standard. Gases with contamination no higher than the highest of the following values in the gas cylinder or at the outlet of a zero-gas generator shall be used:

▼ M2

- (i) 2 % contamination, measured relative to the mean concentration expected at the emission limit value. For example, if a CO concentration of 100,0 $\mu\text{mol/mol}$ is expected, then it would be allowed to use a zero gas with CO contamination less than or equal to 2 000 $\mu\text{mol/mol}$;

▼ B

- (ii) Contamination as specified in Table 6.9, applicable for raw or dilute measurements;
- (iii) Contamination as specified in Table 6.10, applicable for raw measurements.

Table 6.9

Contamination limits, applicable for raw or dilute measurements [$\mu\text{mol/mol}$ = ppm]

Constituent	Purified Synthetic Air ^(a)	Purified N ₂ ^(a)
THC (C ₁ equivalent)	$\leq 0,05 \mu\text{mol/mol}$	$\leq 0,05 \mu\text{mol/mol}$
CO	$\leq 1 \mu\text{mol/mol}$	$\leq 1 \mu\text{mol/mol}$
CO ₂	$\leq 10 \mu\text{mol/mol}$	$\leq 10 \mu\text{mol/mol}$
O ₂	0,205 to 0,215 mol/mol	$\leq 2 \mu\text{mol/mol}$
NO _x	$\leq 0,02 \mu\text{mol/mol}$	$\leq 0,02 \mu\text{mol/mol}$

^(a) It is not required that these levels of purity are internationally and/or nationally recognized standards traceable.

Table 6.10

Contamination limits applicable for raw measurements [$\mu\text{mol/mol}$ = ppm]

Constituent	Purified Synthetic Air ^(a)	Purified N ₂ ^(a)
THC (C ₁ equivalent)	$\leq 1 \mu\text{mol/mol}$	$\leq 1 \mu\text{mol/mol}$
CO	$\leq 1 \mu\text{mol/mol}$	$\leq 1 \mu\text{mol/mol}$
CO ₂	$\leq 400 \mu\text{mol/mol}$	$\leq 400 \mu\text{mol/mol}$
O ₂	0,18 to 0,21 mol/mol	—
NO _x	$\leq 0,1 \mu\text{mol/mol}$	$\leq 0,1 \mu\text{mol/mol}$

^(a) It is not required that these levels of purity are internationally and/or nationally recognized standards traceable.

- (b) The following gases shall be used with a FID analyzer:

- (i) FID fuel shall be used with an H₂ concentration of (0,39 to 0,41) mol/mol, balance He or N₂. The mixture shall not contain more than 0,05 $\mu\text{mol/mol}$ THC;

▼ M2▼ B

▼B

- (ii) FID burner air shall be used that meets the specifications of purified air in paragraph (a) of this point;
 - (iii) FID zero gas. Flame-ionization detectors shall be zeroed with purified gas that meets the specifications in paragraph (a) of this point, except that the purified gas O₂ concentration may be any value;
 - (iv) FID propane span gas. The THC FID shall be spanned and calibrated with span concentrations of propane, C₃H₈. It shall be calibrated on a carbon number basis of one (C₁);
 - (v) Reserved;
- (c) The following gas mixtures shall be used, with gases traceable within ±1,0 % of the international and/or national recognized standards true value or of other gas standards that are approved:

▼M2

- (i) CH₄, balance purified synthetic air and/or N₂ (as applicable);

▼B

- (ii) Reserved;
 - (iii) C₃H₈, balance purified synthetic air and/or N₂ (as applicable);
 - (iv) CO, balance purified N₂;
 - (v) CO₂, balance purified N₂;
 - (vi) NO, balance purified N₂;
 - (vii) NO₂, balance purified synthetic air;
 - (viii) O₂, balance purified N₂;
 - (ix) C₃H₈, CO, CO₂, NO, balance purified N₂;
 - (x) C₃H₈, CH₄, CO, CO₂, NO, balance purified N₂.
- (d) Gases for species other than those listed in paragraph (c) of this point may be used (such as methanol in air, which may be used to determine response factors), as long as they are traceable to within ± 3,0 % of the international and/or national recognized standards true value, and meet the stability requirements of point 9.5.1.2;
- (e) Own calibration gases may be generated using a precision blending device, such as a gas divider, to dilute gases with purified N₂ or purified synthetic air. If the gas dividers meet the specifications in point 9.4.5.6, and the gases being blended meet the requirements of paragraphs (a) and (c) of this point, the resulting blends are considered to meet the requirements of this point 9.5.1.1.

9.5.1.2. Concentration and expiration date

The concentration of any calibration gas standard and its expiration date specified by the gas supplier shall be recorded.

- (a) No calibration gas standard may be used after its expiration date, except as allowed by paragraph (b) of this point.

▼ M2

(b) Calibration gases may be relabelled and used after their expiration date if it is approved in advance by approval authority.

▼ B

9.5.1.3. Gas transfer

Gases shall be transferred from their source to analyzers using components that are dedicated to controlling and transferring only those gases.

▼ M2

▼ B

9.5.2. Mass standards

PM balance calibration weights that are certified as international and/or national recognized standards-traceable within 0,1 % uncertainty shall be used. Calibration weights may be certified by any calibration lab that maintains international and/or national recognized standards-traceability. It shall be made sure that the lowest calibration weight has no greater than ten times the mass of an unused PM-sample medium. The calibration report shall also state the density of the weights.



Appendix 1

Particle number emissions measurement equipment

1. Measurement test procedure

1.1. Sampling

Particle number emissions shall be measured by continuous sampling from either a partial flow dilution system, as described in point 9.2.3 of this Annex or a full flow dilution system as described in point 9.2.2 of this Annex.

1.1.1. Diluent filtration

Diluent used for both the primary and, where applicable, secondary dilution of the exhaust gas in the dilution system shall be passed through filters meeting the High-Efficiency Particulate Air (HEPA) filter requirements defined in Article 1(19). The diluent may optionally be charcoal scrubbed before being passed to the HEPA filter to reduce and stabilize the hydrocarbon concentrations in the diluent. It is recommended that an additional coarse particle filter is situated before the HEPA filter and after the charcoal scrubber, if used.

1.2. Compensating for particle number sample flow — full flow dilution systems

To compensate for the mass flow extracted from the dilution system for particle number sampling the extracted mass flow (filtered) shall be returned to the dilution system. Alternatively, the total mass flow in the dilution system may be mathematically corrected for the particle number sample flow extracted. Where the total mass flow extracted from the dilution system for the sum of particle number sampling and particulate mass sampling is less than 0,5 % of the total diluted exhaust gas flow in the dilution tunnel (med) this correction, or flow return, may be neglected.

1.3. Compensating for particle number sample flow — partial flow dilution systems

1.3.1. For partial flow dilution systems the mass flow extracted from the dilution system for particle number sampling shall be accounted for in controlling the proportionality of sampling. This shall be achieved either by feeding the particle number sample flow back into the dilution system upstream of the flow measuring device or by mathematical correction as outlined in point 1.3.2. In the case of total sampling type partial flow dilution systems, the mass flow extracted for particle number sampling shall also be corrected for in the particulate mass calculation as outlined in point 1.3.3.

1.3.2. The instantaneous exhaust gas flow rate into the dilution system (q_{mp}), used for controlling the proportionality of sampling, shall be corrected according to one of the following methods:

(a) In the case where the extracted particle number sample flow is discarded, equation (6-20) in point 8.1.8.6.1 of this Annex shall be replaced by equation (6-29):

$$q_{mp} = q_{mdew} - q_{mdw} + q_{ex} \quad (6-29)$$

▼B

Where:

q_{mdew} is the diluted exhaust gas mass flow rate, kg/s,

q_{mdw} is the dilution air mass flow rate, kg/s,

q_{ex} is the particle number sample mass flow rate, kg/s.

The q_{ex} signal sent to the partial flow system controller shall be accurate to within $\pm 0,1$ % of q_{mdew} at all times and should be sent with frequency of at least 1 Hz.

- (b) In the case where the extracted particle number sample flow is fully or partially discarded, but an equivalent flow is fed back to the dilution system upstream of the flow measurement device, equation (6-20) in point 8.1.8.6.1 of this Annex shall be replaced by equation (6-30):

$$q_{mp} = q_{mdew} - q_{mdw} + q_{ex} - q_{sw} \quad (6-30)$$

Where:

q_{mdew} is the diluted exhaust gas mass flow rate, kg/s,

q_{mdw} is the dilution air mass flow rate, kg/s,

q_{ex} is the particle number sample mass flow rate, kg/s,

q_{sw} is the mass flow rate fed back into dilution tunnel to compensate for particle number sample extraction, kg/s.

The difference between q_{ex} and q_{sw} sent to the partial flow system controller shall be accurate to within $\pm 0,1$ % of q_{mdew} at all times. The signal (or signals) should be sent with frequency of at least 1 Hz.

1.3.3. Correction of PM measurement

When a particle number sample flow is extracted from a total sampling partial flow dilution system, the mass of particulates (m_{PM}) calculated in point 2.3.1.1 of Annex VII shall be corrected as follows to account for the flow extracted. This correction is required even where filtered extracted flow is fed back into the partial flow dilution systems, as set out in equation (6-31):

$$m_{PM,corr} = m_{PM} \times \frac{m_{sed}}{(m_{sed} - m_{ex})} \quad (6-31)$$

Where:

m_{PM} is the mass of particulates determined in accordance with point 2.3.1.1 of Annex VII, g/test,

m_{sed} is the total mass of diluted exhaust gas passing through the dilution tunnel, kg,

m_{ex} is the total mass of diluted exhaust gas extracted from the dilution tunnel for particle number sampling, kg.

1.3.4. Proportionality of partial flow dilution sampling

► **M2** For particle number measurement, exhaust gas mass flow rate, determined according to any of the methods described in points 2.1.6.1 to 2.1.6.4 of Annex VII, is used for controlling the partial flow dilution system to take a sample proportional to the exhaust gas mass flow rate. ◀ The quality of proportionality shall be checked by applying a regression analysis between sample and exhaust gas flow in accordance with point 8.2.1.2 of this Annex.

1.3.5. Particle number calculation

Determination and calculation of PN are laid down in Appendix 5 of Annex VII.

▼ B

2. **Measurement equipment**
- 2.1. Specification
- 2.1.1. System overview
- 2.1.1.1. The particle sampling system shall consist of a probe or sampling point extracting a sample from a homogeneously mixed flow in a dilution system as described in point 9.2.2 or 9.2.3 of this Annex, a volatile particle remover (VPR) upstream of a particle number counter (PNC) and suitable transfer tubing.
- 2.1.1.2. It is recommended that a particle size pre-classifier (e.g. cyclone, impactor, etc.) be located prior to the inlet of the VPR. However, a sample probe acting as an appropriate size-classification device, such as shown in Figure 6.8, is an acceptable alternative to the use of a particle size pre-classifier. In the case of partial flow dilution systems it is acceptable to use the same pre-classifier for particulate mass and particle number sampling, extracting the particle number sample from the dilution system downstream of the pre-classifier. Alternatively separate pre-classifiers may be used, extracting the particle number sample from the dilution system upstream of the particulate mass pre-classifier.
- 2.1.2. General requirements
- 2.1.2.1. The particle sampling point shall be located within a dilution system.

The sampling probe tip or particle sampling point and particle transfer tube (PTT) together comprise the particle transfer system (PTS). The PTS conducts the sample from the dilution tunnel to the entrance of the VPR. The PTS shall meet the following conditions:

In the case of full flow dilution systems and partial flow dilution systems of the fractional sampling type (as described in point 9.2.3 of this Annex) the sampling probe shall be installed near the tunnel centre line, 10 to 20 tunnel diameters downstream of the gas inlet, facing upstream into the tunnel gas flow with its axis at the tip parallel to that of the dilution tunnel. The sampling probe shall be positioned within the dilution tract so that the sample is taken from a homogeneous diluent/exhaust gas mixture.

In the case of partial flow dilution systems of the total sampling type (as described in point 9.2.3 of this Annex) the particle sampling point or sampling probe shall be located in the particulate transfer tube, upstream of the particulate filter holder, flow measurement device and any sample/bypass bifurcation point. The sampling point or sampling probe shall be positioned so that the sample is taken from a homogeneous diluent/exhaust gas mixture. The dimensions of the particle sampling probe should be sized not to interfere with the operation of the partial flow dilution system.

Sample gas drawn through the PTS shall meet the following conditions:

- (a) In the case of full flow dilution systems, it shall have a flow Reynolds number (Re) of $< 1\,700$;
- (b) In the case of partial flow dilution systems, it shall have a flow Reynolds number (Re) of $< 1\,700$ in the PTT i.e. downstream of the sampling probe or point;

▼B

- (c) It shall have a residence time in the PTS of ≤ 3 seconds.
 - (d) Any other sampling configuration for the PTS for which equivalent particle penetration at 30 nm can be demonstrated will be considered acceptable.
 - (e) The outlet tube (OT) conducting the diluted sample from the VPR to the inlet of the PNC shall have the following properties:
 - (f) It shall have an internal diameter of ≥ 4 mm;
 - (g) Sample Gas flow through the OT shall have a residence time of $\leq 0,8$ second.
 - (h) Any other sampling configuration for the OT for which equivalent particle penetration at 30 nm can be demonstrated will be considered acceptable.
- 2.1.2.2. The VPR shall include devices for sample dilution and for volatile particle removal.
- 2.1.2.3. All parts of the dilution system and the sampling system from the exhaust pipe up to the PNC, which are in contact with raw and diluted exhaust gas, shall be designed to minimize deposition of the particles. All parts shall be made of electrically conductive materials that do not react with exhaust gas components, and shall be electrically grounded to prevent electrostatic effects.
- 2.1.2.4. The particle sampling system shall incorporate good aerosol sampling practice that includes the avoidance of sharp bends and abrupt changes in cross-section, the use of smooth internal surfaces and the minimisation of the length of the sampling line. Gradual changes in the cross-section are permissible.
- 2.1.3. Specific requirements
- 2.1.3.1. The particle sample shall not pass through a pump before passing through the PNC.
- 2.1.3.2. A sample pre-classifier is recommended.
- 2.1.3.3. The sample preconditioning unit shall:
 - 2.1.3.3.1. Be capable of diluting the sample in one or more stages to achieve a particle number concentration below the upper threshold of the single particle count mode of the PNC and a gas temperature below 308 K (35 °C) at the inlet to the PNC;
 - 2.1.3.3.2. Include an initial heated dilution stage which outputs a sample at a temperature of ≥ 423 K (150 °C) and ≤ 673 K (400 °C), and dilutes by a factor of at least 10;
 - 2.1.3.3.3. ►**M2** Control heated stages to constant nominal operating temperatures, within the range specified in point 2.1.3.3.2, to a tolerance of ± 10 K (± 10 °C). ◀ Provide an indication of whether or not heated stages are at their correct operating temperatures;
 - 2.1.3.3.4. Achieve a particle concentration reduction factor ($f_r(d_i)$), as defined in point 2.2.2.2, for particles of 30 nm and 50 nm electrical mobility diameters, that is no more than 30 % and 20 % respectively higher, and no more than 5 % lower than that for particles of 100 nm electrical mobility diameter for the VPR as a whole;

▼B

- 2.1.3.3.5. Also achieve > 99,0 % vaporisation of 30 nm tetracontane ($\text{CH}_3(\text{CH}_2)_{38}\text{CH}_3$) particles, with an inlet concentration of $\geq 10\,000\text{ cm}^{-3}$, by means of heating and reduction of partial pressures of the tetracontane.
- 2.1.3.4. The PNC shall:
- 2.1.3.4.1. Operate under full flow operating conditions;
- 2.1.3.4.2. Have a counting accuracy of $\pm 10\%$ across the range 1 cm^{-3} to the upper threshold of the single particle count mode of the PNC against a traceable standard. At concentrations below 100 cm^{-3} measurements averaged over extended sampling periods may be required to demonstrate the accuracy of the PNC with a high degree of statistical confidence;
- 2.1.3.4.3. Have a readability of at least $0,1\text{ particle cm}^{-3}$ at concentrations below 100 cm^{-3} ;
- 2.1.3.4.4. Have a linear response to particle concentrations over the full measurement range in single particle count mode;
- 2.1.3.4.5. Have a data reporting frequency equal to or greater than $0,5\text{ Hz}$;
- 2.1.3.4.6. Have a response time over the measured concentration range of less than 5 s ;
- 2.1.3.4.7. Incorporate a coincidence correction function up to a maximum 10% correction, and may make use of an internal calibration factor as determined in point 2.2.1.3, but shall not make use of any other algorithm to correct for or define the counting efficiency;
- 2.1.3.4.8. Have counting efficiencies at particle sizes of 23 nm ($\pm 1\text{ nm}$) and 41 nm ($\pm 1\text{ nm}$) electrical mobility diameter of 50% ($\pm 12\%$) and $> 90\%$ respectively. These counting efficiencies may be achieved by internal (for example; control of instrument design) or external (for example; size pre-classification) means;
- 2.1.3.4.9. If the PNC makes use of a working liquid, it shall be replaced at the frequency specified by the instrument manufacturer.
- 2.1.3.5. Where they are not held at a known constant level at the point at which PNC flow rate is controlled, the pressure and/or temperature at inlet to the PNC shall be measured and reported for the purposes of correcting particle concentration measurements to standard conditions.
- 2.1.3.6. The sum of the residence time of the PTS, VPR and OT plus the response time of the PNC shall be no greater than 20 s .
- 2.1.3.7. The transformation time of the entire particle number sampling system (PTS, VPR, OT and PNC) shall be determined by aerosol switching directly at the inlet of the PTS. The aerosol switching shall be done in less than $0,1\text{ s}$. The aerosol used for the test shall cause a concentration change of at least 60% full scale (FS).

The concentration trace shall be recorded. For time alignment of the particle number concentration and exhaust gas flow signals, the transformation time is defined as the time from the change (t_0) until the response is 50% of the final reading (t_{50}).

▼ B

2.1.4. Recommended system description

This point contains the recommended practice for measurement of particle number. However, any system meeting the performance specifications in points 2.1.2 and 2.1.3 is acceptable.

Figures 6.9 and 6.10 are schematic drawings of the recommended particle sampling system configures for partial and full flow dilution systems respectively.

Figure 6.9

Schematic of recommended particle sampling system — Partial flow sampling

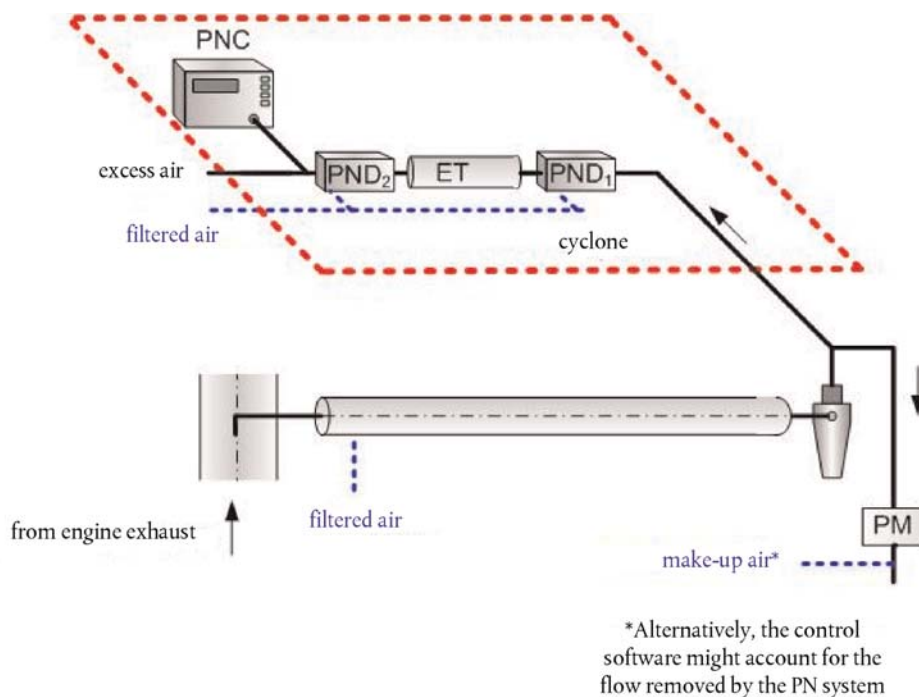

▼ M2

Figure 6.10

Schematic of recommended particle sampling system – Full flow sampling

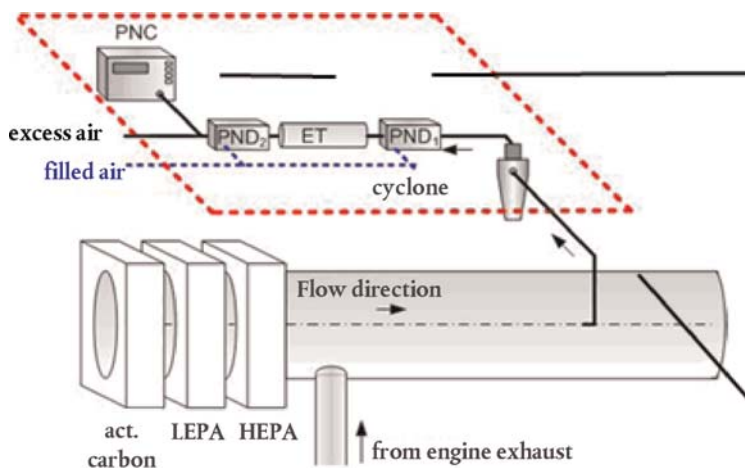

▼B

2.1.4.1. Sampling system description

The particle sampling system shall consist of a sampling probe tip or particle sampling point in the dilution system, a particle transfer tube (PTT), a particle pre-classifier (PCF) and a volatile particle remover (VPR) upstream of the particle number concentration measurement (PNC) unit. The VPR shall include devices for sample dilution (particle number diluters: PND₁ and PND₂) and particle evaporation (Evaporation tube, ET). The sampling probe or sampling point for the test gas flow shall be so arranged within the dilution tract that a representative sample gas flow is taken from a homogeneous diluent/exhaust gas mixture. The sum of the residence time of the system plus the response time of the PNC shall be no greater than 20 s.

2.1.4.2. Particle transfer system

The sampling probe tip or particle sampling point and Particle Transfer Tube (PTT) together comprise the Particle Transfer System (PTS). The PTS conducts the sample from the dilution tunnel to the entrance to the first particle number diluter. The PTS shall meet the following conditions:

In the case of full flow dilution systems and partial flow dilution systems of the fractional sampling type (as described in point 9.2.3 of this Annex) the sampling probe shall be installed near the tunnel centre line, 10 to 20 tunnel diameters downstream of the gas inlet, facing upstream into the tunnel gas flow with its axis at the tip parallel to that of the dilution tunnel. The sampling probe shall be positioned within the dilution tract so that the sample is taken from a homogeneous diluent/exhaust gas mixture.

In the case of partial flow dilution systems of the total sampling type (as described in point 9.2.3 of this Annex) the particle sampling point shall be located in the particulate transfer tube, upstream of the particulate filter holder, flow measurement device and any sample/bypass bifurcation point. The sampling point or sampling probe shall be positioned so that the sample is taken from a homogeneous diluent/exhaust gas mixture.

Sample gas drawn through the PTS shall meet the following conditions:

It shall have a flow Reynolds number (Re) of $< 1\,700$;

It shall have a residence time in the PTS of ≤ 3 seconds.

Any other sampling configuration for the PTS for which equivalent particle penetration for particles of 30 nm electrical mobility diameter can be demonstrated will be considered acceptable.

The outlet tube (OT) conducting the diluted sample from the VPR to the inlet of the PNC shall have the following properties:

It shall have an internal diameter of ≥ 4 mm;

Sample gas flow through the POT shall have a residence time of $\leq 0,8$ second.

▼B

Any other sampling configuration for the OT for which equivalent particle penetration for particles of 30 nm electrical mobility diameter can be demonstrated will be considered acceptable.

2.1.4.3. Particle pre-classifier

The recommended particle pre-classifier shall be located upstream of the VPR. The pre-classifier 50 % cut point particle diameter shall be between 2,5 µm and 10 µm at the volumetric flow rate selected for sampling particle number emissions. The pre-classifier shall allow at least 99 % of the mass concentration of 1 µm particles entering the pre-classifier to pass through the exit of the pre-classifier at the volumetric flow rate selected for sampling particle number emissions. In the case of partial flow dilution systems, it is acceptable to use the same pre-classifier for particulate mass and particle number sampling, extracting the particle number sample from the dilution system downstream of the pre-classifier. Alternatively separate pre-classifiers may be used, extracting the particle number sample from the dilution system upstream of the particulate mass pre-classifier.

2.1.4.4. Volatile particle remover (VPR)

The VPR shall comprise one particle number diluter (PND₁), an evaporation tube and a second diluter (PND₂) in series. This dilution function is to reduce the number concentration of the sample entering the particle concentration measurement unit to less than the upper threshold of the single particle count mode of the PNC and to suppress nucleation within the sample. The VPR shall provide an indication of whether or not PND₁ and the evaporation tube are at their correct operating temperatures.

The VPR shall achieve > 99,0 % vaporisation of 30 nm tetracontane (CH₃(CH₂)₃₈CH₃) particles, with an inlet concentration of $\geq 10\,000\text{ cm}^{-3}$, by means of heating and reduction of partial pressures of the tetracontane. It shall also achieve a particle concentration reduction factor (f_r) for particles of 30 nm and 50 nm electrical mobility diameters, that is no more than 30 % and 20 % respectively higher, and no more than 5 % lower than that for particles of 100 nm electrical mobility diameter for the VPR as a whole.

2.1.4.4.1. First particle number dilution device (PND₁)

The first particle number dilution device shall be specifically designed to dilute particle number concentration and operate at a (wall) temperature of 423 K to 673 K (150 °C to 400 °C). The wall temperature set point should be held at a constant nominal operating temperature, within this range, to a tolerance of $\pm 10\text{ °C}$ and not exceed the wall temperature of the ET (point 2.1.4.4.2). The diluter should be supplied with HEPA filtered dilution air and be capable of a dilution factor of 10 to 200 times.

2.1.4.4.2. Evaporation Tube (ET)

The entire length of the ET shall be controlled to a wall temperature greater than or equal to that of the first particle number dilution device and the wall temperature held at a fixed nominal operating temperature between 300 °C and 400 °C, to a tolerance of $\pm 10\text{ °C}$.

▼ B2.1.4.4.3. Second particle number dilution device (PND₂)

PND₂ shall be specifically designed to dilute particle number concentration. The diluter shall be supplied with HEPA filtered dilution air and be capable of maintaining a single dilution factor within a range of 10 to 30 times. The dilution factor of PND₂ shall be selected in the range between 10 and 15 such that particle number concentration downstream of the second diluter is less than the upper threshold of the single particle count mode of the PNC and the gas temperature prior to entry to the PNC is < 35 °C.

2.1.4.5. Particle number counter (PNC)

The PNC shall meet the requirements of point 2.1.3.4.

2.2. Calibration/Validation of the particle sampling system ⁽¹⁾

2.2.1. Calibration of the particle number counter

2.2.1.1 The Technical Service shall ensure the existence of a calibration certificate for the PNC demonstrating compliance with a traceable standard within a 12-month period prior to the emissions test.

2.2.1.2. The PNC shall also be recalibrated and a new calibration certificate issued following any major maintenance.

2.2.1.3. Calibration shall be traceable to a standard calibration method:

- (a) By comparison of the response of the PNC under calibration with that of a calibrated aerosol electrometer when simultaneously sampling electrostatically classified calibration particles; or
- (b) By comparison of the response of the PNC under calibration with that of a second PNC which has been directly calibrated by the above method.

In the electrometer case, calibration shall be undertaken using at least six standard concentrations spaced as uniformly as possible across the PNC's measurement range. These points will include a nominal zero concentration point produced by attaching HEPA filters of at least class H13 of EN 1822:2008, or equivalent performance, to the inlet of each instrument. With no calibration factor applied to the PNC under calibration, measured concentrations shall be within $\pm 10\%$ of the standard concentration for each concentration used, with the exception of the zero point, otherwise the PNC under calibration shall be rejected. The gradient from a linear regression of the two data sets shall be calculated and recorded. A calibration factor equal to the reciprocal of the gradient shall be applied to the PNC under calibration. Linearity of response is calculated as the square of the Pearson product moment correlation coefficient (R^2) of the two data sets and shall be equal to or greater than 0,97. In calculating both the gradient and R^2 the linear regression shall be forced through the origin (zero concentration on both instruments).

⁽¹⁾ Example calibration/validation methods are available at: www.unece.org/es/trans/main/wp29/wp29wgs/wp29grpe/pmpfcp

▼ B

In the reference PNC case, calibration shall be undertaken using at least six standard concentrations across the PNC's measurement range. At least 3 points shall be at concentrations below $1\,000\text{ cm}^{-3}$, the remaining concentrations shall be linearly spaced between $1\,000\text{ cm}^{-3}$ and the maximum of the PNC's range in single particle count mode. These points will include a nominal zero concentration point produced by attaching HEPA filters of at least class H13 of EN 1822:2008, or equivalent performance, to the inlet of each instrument. With no calibration factor applied to the PNC under calibration, measured concentrations shall be within $\pm 10\%$ of the standard concentration for each concentration, with the exception of the zero point, otherwise the PNC under calibration shall be rejected. The gradient from a linear regression of the two data sets shall be calculated and recorded. A calibration factor equal to the reciprocal of the gradient shall be applied to the PNC under calibration. Linearity of response is calculated as the square of the Pearson product moment correlation coefficient (R^2) of the two data sets and shall be equal to or greater than 0,97. In calculating both the gradient and R^2 the linear regression shall be forced through the origin (zero concentration on both instruments).

- 2.2.1.4. Calibration shall also include a check, against the requirements in point 2.1.3.4.8, on the PNC's detection efficiency with particles of 23 nm electrical mobility diameter. A check of the counting efficiency with 41 nm particles is not required.

2.2.2. Calibration/Validation of the volatile particle remover

- 2.2.2.1. Calibration of the VPR's particle concentration reduction factors across its full range of dilution settings, at the instrument's fixed nominal operating temperatures, shall be required when the unit is new and following any major maintenance. The periodic validation requirement for the VPR's particle concentration reduction factor is limited to a check at a single setting, typical of that used for measurement on diesel particulate filter equipped non-road mobile machinery. The Technical Service shall ensure the existence of a calibration or validation certificate for the volatile particle remover within a 6-month period prior to the emissions test. If the volatile particle remover incorporates temperature monitoring alarms a 12 month validation interval shall be permissible.

The VPR shall be characterised for particle concentration reduction factor with solid particles of 30 nm, 50 nm and 100 nm electrical mobility diameter. Particle concentration reduction factors ($f_r(d)$) for particles of 30 nm and 50 nm electrical mobility diameters shall be no more than 30 % and 20 % higher respectively, and no more than 5 % lower than that for particles of 100 nm electrical mobility diameter. For the purposes of validation, the mean particle concentration reduction factor shall be within $\pm 10\%$ of the mean particle concentration reduction factor (\bar{f}_r) determined during the primary calibration of the VPR.

- 2.2.2.2. The test aerosol for these measurements shall be solid particles of 30, 50 and 100 nm electrical mobility diameter and a minimum concentration of $5\,000\text{ particles cm}^{-3}$ at the VPR inlet. Particle concentrations shall be measured upstream and downstream of the components.

▼ B

The particle concentration reduction factor at each particle size ($f_r(d_i)$) shall be calculated by means of equation (6-32):

$$f_r(d_i) = \frac{N_{in}(d_i)}{N_{out}(d_i)} \quad (6-32)$$

Where:

$N_{in}(d_i)$ is the upstream particle number concentration for particles of diameter d_i

$N_{out}(d_i)$ is the downstream particle number concentration for particles of diameter d_i

d_i is the particle electrical mobility diameter (30, 50 or 100 nm)

$N_{in}(d_i)$ and $N_{out}(d_i)$ shall be corrected to the same conditions.

The mean particle concentration reduction (\bar{f}_r) at a given dilution setting shall be calculated by means of equation (6-33):

$$\bar{f}_r = \frac{f_r(30nm) + f_r(50nm) + f_r(100nm)}{3} \quad (6-33)$$

It is recommended that the VPR is calibrated and validated as a complete unit.

- 2.2.2.3. The Technical Service shall ensure the existence of a validation certificate for the VPR demonstrating effective volatile particle removal efficiency within a 6 month period prior to the emissions test. If the volatile particle remover incorporates temperature monitoring alarms a 12 month validation interval shall be permissible. The VPR shall demonstrate greater than 99,0 % removal of tetracontane ($\text{CH}_3(\text{CH}_2)_{38}\text{CH}_3$) particles of at least 30 nm electrical mobility diameter with an inlet concentration of $\geq 10\,000\text{ cm}^{-3}$ when operated at its minimum dilution setting and manufacturers recommended operating temperature.
- 2.2.3. Particle number system check procedures
- 2.2.3.1. Prior to each test, the particle counter shall report a measured concentration of less than $0,5\text{ particles cm}^{-3}$ when a HEPA filter of at least class H13 of EN 1822:2008, or equivalent performance, is attached to the inlet of the entire particle sampling system (VPR and PNC).
- 2.2.3.2. On a monthly basis, the flow into the particle counter shall report a measured value within 5 % of the particle counter nominal flow rate when checked with a calibrated flow meter.
- 2.2.3.3. Each day, following the application of a HEPA filter of at least class H13 of EN 1822:2008, or equivalent performance, to the inlet of the particle counter, the particle counter shall report a concentration of $\leq 0,2\text{ cm}^{-3}$. Upon removal of this filter, the particle counter shall show an increase in measured concentration to at least $100\text{ particles cm}^{-3}$ when challenged with ambient air and a return to $\leq 0,2\text{ cm}^{-3}$ on replacement of the HEPA filter.
- 2.2.3.4. Prior to the start of each test it shall be confirmed that the measurement system indicates that the evaporation tube, where featured in the system, has reached its correct operating temperature.
- 2.2.3.5. Prior to the start of each test it shall be confirmed that the measurement system indicates that the diluter PND₁ has reached its correct operating temperature.



Appendix 2

Installation requirements for equipment and auxiliaries

Number	Equipment and auxiliaries	Fitted for emission test
1	Inlet system	
	Inlet manifold	Yes
	Crankcase emission control system	Yes
	Air flow meter	Yes
	Air filter	Yes ^(a)
	Inlet silencer	Yes ^(a)
2	Exhaust system	
	Exhaust after-treatment system	Yes
	Exhaust manifold	Yes
	Connecting pipes	Yes ^(b)
	Silencer	Yes ^(b)
	Tail pipe	Yes ^(b)
	Exhaust brake	No ^(c)
	Pressure charging device	Yes
3	Fuel supply pump	Yes ^(d)
4	Fuel injection equipment	
	Prefilter	Yes
	Filter	Yes
	Pump	Yes
5	High-pressure pipe	Yes
	Injector	Yes
	Electronic control unit, sensors, etc.	Yes
	Governor/control system	Yes
	Automatic full-load stop for the control rack depending on atmospheric conditions	Yes
6	Liquid-cooling equipment	
	Radiator	No
	Fan	No
	Fan cowl	No
	Water pump	Yes ^(e)
	Thermostat	Yes ^(f)
7	Air cooling	
	Cowl	No ^(g)
	Fan or Blower	No ^(g)
	Temperature-regulating device	No

▼B

Number	Equipment and auxiliaries	Fitted for emission test
8	Pressure charging equipment Compressor driven either directly by the engine and/or by the exhaust system Charge air cooler Coolant pump or fan (engine-driven) Coolant flow control device	Yes Yes ^(g) ^(h) No ^(g) Yes
9	Auxiliary test-bed fan	Yes, if necessary
10	Anti-pollution device	Yes
11	Starting equipment	Yes or test bed equipment ⁽ⁱ⁾
12	Lubricating oil pump	Yes
13	Certain auxiliaries whose definition is linked with the operation of the non-road mobile machinery and which may be mounted on the engine shall be removed for the test. The following non-exhaustive list is given as an example: (i) air compressor for brakes (ii) power steering compressor (iii) suspension compressor (iv) air-conditioning system.	No

^(a) The complete inlet system shall be fitted as provided for the intended application:

- (i) where there is a risk of an appreciable effect on the engine power;
- (ii) when the manufacturer requests that this should be done.

In other cases, an equivalent system may be used and a check should be made to ascertain that the intake pressure does not differ by more than 100 Pa from the upper limit specified by the manufacturer for a clean air filter.

^(b) The complete exhaust system shall be fitted as provided for the intended application:

- (i) where there is a risk of an appreciable effect on the engine power;
- (ii) when the manufacturer requests that this should be done.

In other cases, an equivalent system may be installed provided the pressure measured does not differ by more than 1 000 Pa from the upper limit specified by the manufacturer.

^(c) If an exhaust system brake is incorporated in the engine, the throttle valve shall be fixed in the fully open position.

^(d) The fuel feed pressure may be adjusted, if necessary, to reproduce the pressure existing in the particular engine application (particularly when a 'fuel return' system is used).

^(e) The cooling-liquid circulation shall be operated by the engine water pump only. Cooling of the liquid may be produced by an external circuit, such that the pressure loss of this circuit and the pressure at the pump inlet remain substantially the same as those of the engine cooling system.

^(f) The thermostat may be fixed in the fully open position.

^(g) When the cooling fan or blower is fitted for the test, the power absorbed shall be added to the results, except for cooling fans of air cooled engines directly fitted on the crankshaft. The fan or blower power shall be determined at the speeds used for the test either by calculation from standard characteristics or by practical tests.

^(h) Charge air-cooled engines shall be tested with charge air cooling, whether liquid — or air-cooled, but if the manufacturer prefers, a test bench system may replace the air cooler. In either case, the measurement of power at each speed shall be made with the maximum pressure drop and the minimum temperature drop of the engine air across the charge air cooler on the test bench system as those specified by the manufacturer.

⁽ⁱ⁾ The power for electrical or other starting systems shall be provided from the test bed.

▼B*Appendix 3***Verification of torque signal broadcast by electronic control unit****1. Introduction**

The purpose of this Appendix is to set out the requirements for verification in the case that the manufacturer intends to use the torque signal broadcast by the electronic control unit (ECU), of engines so equipped, during the conduct of in-service monitoring tests according to Delegated Regulation (EU) 2017/655.

The basis for the net torque shall be uncorrected net torque delivered by the engine inclusive of the equipment and auxiliaries to be included for an emissions test according to Appendix 2.

2. ECU torque signal

With the engine installed on the test bench for conducting the mapping procedure, means shall be provided to read the torque signal broadcast by the ECU according to the requirements of Appendix 6 of Annex 1 to Delegated Regulation (EU) 2017/655.

3. Verification procedure

When conducting the mapping procedure according to section 7.6.2 of this Annex readings of the torque measured by the dynamometer and torque broadcast by the ECU shall be taken simultaneously at a minimum of three points on the torque curve. At least one of the readings shall be taken at a point on the curve where the torque is no less than 98 % of the maximum value.

► **M2** The torque broadcast by the ECU shall be accepted without correction if, at each point where measurements were taken, the factor calculated from dividing the torque value from the dynamometer by the torque value from the ECU is not less than 0,93 (i.e. a maximum difference of 7 %). ◀ In this case it shall be recorded in the type approval certificate that the torque broadcast by the ECU has been verified without correction. Where the factor at one or more test points is less than 0,93 the average correction factor shall be determined from all the points where readings were taken and recorded in the type approval certificate. Where a factor is recorded in the type approval certificate it shall be applied to the torque broadcast by the ECU when conducting in-service monitoring tests according to Delegated Regulation (EU) 2017/655.

*Appendix 4***Procedure for the measurement of ammonia**

1. This appendix describes the procedure for measurement of ammonia (NH₃). For non-linear analysers, the use of linearising circuits shall be permitted.
2. Three measurement principles are specified for NH₃ measurement and either principle may be used provided it meets the criteria specified in points 2.1, 2.2 or 2.3, respectively. Gas dryers shall not be permitted for NH₃ measurement.

- 2.1. Fourier Transform Infrared (hereinafter 'FTIR') analyser

- 2.1.1. Measurement principle

The FTIR employs the broad waveband infrared spectroscopy principle. It allows simultaneous measurement of exhaust gas components whose standardized spectra are available in the instrument. The absorption spectrum (intensity/wavelength) is calculated from the measured interferogram (intensity/time) by means of the Fourier transform method.

- 2.1.2. Installation and sampling

The FTIR shall be installed in accordance with the instrument manufacturer's instructions. The NH₃ wavelength shall be selected for evaluation. The sample path (sampling line, pre-filter(s) and valves) shall be made of stainless steel or PTFE and shall be heated to set points between 383 K (110 °C) and 464 K (191 °C) in order to minimize NH₃ losses and sampling artefacts. In addition, the sampling line shall be as short as practically possible.

- 2.1.3. Cross interference

The spectral resolution of the NH₃ wavelength shall be within 0,5 cm⁻¹ in order to minimize cross interference from other gases present in the exhaust gas.

- 2.2. Non Dispersive Ultra Violet Resonance Absorption analyser (hereinafter 'NDUV')

- 2.2.1. Measurement Principle

The NDUV is based on a purely physical principle, no auxiliary gases or equipment is necessary. The main element of the photometer is an electrode-less discharge lamp. It produces a sharply structured radiation in the ultraviolet range, enabling the measurement of several components such as NH₃.

The photometric system has a dual beam in time design set up to produce a measuring and a reference beam by filter correlation technique.

In order to achieve a high stability of the measuring signal the dual beam in time design is combined with a dual beam in space design. The detector signals processing fosters an almost negligible amount of zero point drift rate.

In the calibration mode of the analyser a sealed-off quartz cell is tilted into the beam path to obtain an exact calibration value, since any reflection and absorption losses of the cell windows are compensated. Since the gas filling of the cell is very stable, this calibration method leads to a very high long term stability of the photometer.

▼ B

2.2.2. Installation

The analyser shall be installed within an analyser cabinet using extractive sampling in accordance with the instrument manufacturer's instructions. The analyzer location shall be capable of supporting the weight specified by the manufacturer.

The sample path (sampling line, pre-filter(s) and valves) shall be made of stainless steel or PTFE and shall be heated to set points between 383 K (110 °C) and 464 K (191 °C).

In addition, the sampling line shall be as short as possible. Influence from exhaust gas temperature and pressure, installation environment and vibrations on the measurement shall be minimized.

The gas analyzer shall be protected from cold, heat, temperature variations, and strong air currents, accumulation of dust, corrosive atmosphere and vibrations. Adequate air circulation shall be provided to avoid heat build-up. The complete surface shall be used to dissipate the heat losses.

2.2.3. Cross Sensitivity

An appropriate spectral range shall be chosen in order to minimize cross interferences of accompanying gases. Typical components causing cross sensitivities on the NH₃ measurement are SO₂, NO₂ and NO.

Additionally, further methods can be applied to reduce the cross sensitivities.

(a) Usage of interference filters;

(b) Cross sensitivity compensation by measuring cross sensitivity components and using the measurement signal for compensation.

2.3. Laser Infrared analyser

2.3.1. Measurement principle

An infrared laser such as a tunable diode laser (TDL) or a quantum cascade laser (QCL) can emit coherent light in the near-infrared region or in mid-infrared region respectively where nitrogen compounds including NH₃ have strong absorption. This laser optics can give a pulsed-mode high resolution narrow band near-infrared or mid-infrared spectrum. Therefore, laser infrared analyzers can reduce interference caused by the spectral overlap of co-existing components in engine exhaust gas.

2.3.2. Installation

The analyser shall be installed either directly in the exhaust pipe (in-situ) or within an analyser cabinet using extractive sampling in accordance with the instrument manufacturer's instructions. If installed in an analyser cabinet, the sample path (sampling line, pre-filter(s) and valves) shall be made of stainless steel or PTFE and shall be heated to set points between 383 K (110 °C) and 464 K (191 °C) in order to minimize NH₃ losses and sampling artefacts. In addition, the sampling line shall be as short as practically possible.

Influence from exhaust gas temperature and pressure, installation environment and vibrations on the measurement shall be minimized, or compensation techniques be used.

▼ B

If applicable, sheath air used in conjunction with in-situ measurement for protection of the instrument, shall not affect the concentration of any exhaust gas component measured downstream of the device, or sampling of other exhaust gas components shall be made upstream of the device.

2.3.3. Interference verification for NH₃ laser infrared analyzers (cross interference)

2.3.3.1. Scope and frequency

If NH₃ is measured using laser infrared analyser, the amount of interference shall be verified after initial analyser installation and after major maintenance.

2.3.3.2. Measurement principles for interference verification

Interference gasses can positively interfere with certain laser infrared analyzer by causing a response similar to NH₃. If the analyzer uses compensation algorithms that utilize measurements of other gases to meet this interference verification, these other measurements shall be simultaneously conducted to test the compensation algorithms during the analyzer interference verification.

Good engineering judgment shall be used to determine interference gases for laser infrared analyzer. Note that interference species, with the exception of H₂O, are dependent on the NH₃ infrared absorption band chosen by the instrument manufacturer. For each analyzer the NH₃ infrared absorption band shall be determined. For each NH₃ infrared absorption band, good engineering judgment shall be used to determine interference gases to use in the verification.

3. Emissions test procedure

3.1. Checking the analysers

Prior to the emissions test, the analyser range shall be selected. Emission analysers with automatic or manual range switching shall be permitted. During the test cycle, the range of the analysers shall not be switched.

Zero and span response shall be determined, if the provisions set out in point 3.4.2 do not apply for the instrument. For the span response, a NH₃ gas that meets the specifications set out in point 4.2.7, shall be used. The use of reference cells that contain NH₃ span gas is permitted.

3.2. Collection of emission relevant data

At the start of the test sequence, the NH₃ data collection shall be started, simultaneously. The NH₃ concentration shall be measured continuously and stored with at least 1 Hz on a computer system.

3.3. Operations after test

At the completion of the test, sampling shall continue until system response times have elapsed. Determination of analyser's drift in accordance with point 3.4.1 shall only be required if the information required in point 3.4.2 is not available.

3.4. Analyser drift

3.4.1. As soon as practical but no later than 30 minutes after the test cycle is complete or during the soak period, the zero and span responses of the analyser shall be determined. ► **M2** The difference between the pre-test and post-test results shall be less than 2 % of full scale. ◀

▼B

3.4.2. Determination of analyser drift is not required in the following situations:

- (a) If the zero and span drift specified by the instrument manufacturer in points 4.2.3 and 4.2.4 meets the requirements of point 3.4.1;
- (b) The time interval for zero and span drift specified by the instrument manufacturer in points 4.2.3 and 4.2.4 exceeds the duration of the test.

4. Analyser specification and verification

4.1. Linearity requirements

The analyser shall comply with the linearity requirements specified in Table 6.5 of this Annex. The linearity verification in accordance with point 8.1.4 of this Annex shall be performed at least at the minimum frequency set out in Table 6.4 of this Annex. With the prior approval of the approval authority, less than 10 reference points are permitted, if an equivalent accuracy can be demonstrated.

For the linearity verification, a NH_3 gas that meets the specifications set out in point 4.2.7 shall be used. The use of reference cells that contain NH_3 span gas shall be permitted.

Instruments, whose signals are used for compensation algorithms, shall meet the linearity requirements specified in Table 6.5 of this Annex. Linearity verification shall be done as required by internal audit procedures, by the instrument manufacturer or in accordance with ISO 9000 requirements.

4.2. Analyser specifications

The analyser shall have a measuring range and response time appropriate for the accuracy required to measure the concentration of NH_3 under transient and steady state conditions.

4.2.1. Minimum detection limit

The analyser shall have a minimum detection limit of < 2 ppm under all conditions of testing.

4.2.2. Accuracy

The accuracy, defined as the deviation of the analyser reading from the reference value, shall not exceed $\pm 3\%$ of the reading or ± 2 ppm, whichever is larger.

4.2.3. Zero drift

The drift of the zero response and the related time interval shall be specified by the instrument manufacturer.

4.2.4. Span drift

The drift of the span response and the related time interval shall be specified by the instrument manufacturer.

4.2.5. System response time

The system response time shall be ≤ 20 s.

4.2.6. Rise time

The rise time of the analyser shall be ≤ 5 s.

4.2.7. NH_3 calibration gas

A gas mixture with the following chemical composition shall be available.

NH_3 and purified nitrogen.

▼ B

The true concentration of the calibration gas shall be within $\pm 3\%$ of the nominal value. The concentration of NH_3 shall be given on a volume basis (volume per cent or volume ppm).

▼ M2

The expiration date of the calibration gases shall be recorded.

▼ B

4.2.8. Interference verification procedure

The interference verification shall be performed as follows:

- (a) The NH_3 analyzer shall be started, operated, zeroed, and spanned as it would be before an emission test;
- (b) A humidified interference test gas shall be created by bubbling a multi component span gas through distilled H_2O in a sealed vessel. If the sample is not passed through a sample dryer, the vessel temperature shall be controlled to generate an H_2O level at least as high as the maximum expected during emission testing. Interference span gas concentrations shall be used at least as high as the maximum expected during testing;
- (c) The humidified interference test gas shall be introduced into the sample system.
- (d) The water mole fraction, $x_{\text{H}_2\text{O}}$, of the humidified interference test gas shall be measured, as close as possible to the inlet of the analyzer. For example, dew point, T_{dew} , and absolute pressure, p_{total} , shall be measured to calculate $x_{\text{H}_2\text{O}}$;
- (e) Good engineering judgment shall be used to prevent condensation in the transfer lines, fittings, or valves from the point where $x_{\text{H}_2\text{O}}$ is measured to the analyzer;
- (f) Time shall be allowed for the analyser response to stabilize;
- (g) While the analyser measures the sample's concentration, its output shall be recorded for 30 s. The arithmetic mean of this data shall be calculated;
- (h) The analyzer meets the interference verification if the result of paragraph (g) of this point meets the tolerance in this section.
- (i) Interference procedures for individual interference gases may also run separately. If the interference gas levels used are higher than the maximum levels expected during testing, each observed interference value may be scaled down by multiplying the observed interference by the ratio of the maximum expected concentration value to the actual value used during this procedure. Separate interference concentrations of H_2O (down to 0,025 mol/mol H_2O content) that are lower than the maximum levels expected during testing may be run, but the observed H_2O interference shall be scaled up by multiplying the observed interference by the ratio of the maximum expected H_2O concentration value to the actual value used during this procedure. The sum of the scaled interference values must meet the tolerance for combined interference as specified in paragraph (j) of this point.

▼ **M2**

- (j) Analyser shall have combined interference within ± 2 % of the applicable mean value of ammonia (NH₃) specified in point 3.4 of Annex IV.

▼ **B**

5. Alternative systems

Other systems or analysers may be approved by the approval authority, if it is found that they yield equivalent results in accordance with point 5.1.1 of this Annex. In this case, 'Results' in that point shall refer to mean NH₃ concentration calculated for the applicable cycle.

▼ B

Appendix 5

Description of system responses

1. This appendix describes the times used to express the response of analytical systems and other measurement systems to an input signal.
2. The following times apply, as shown in figure 6-11:
 - 2.1. Delay time is the difference in time between the change of the component to be measured at the reference point and a system response of 10 % of the final reading (t_{10}) with the sampling probe being defined as the reference point.
 - 2.2. Response time is the difference in time between the change of the component to be measured at the reference point and a system response of 90 % of the final reading (t_{90}) with the sampling probe being defined as the reference point.
 - 2.3. Rise time is the difference in time the 10 % and 90 % response of the final reading ($t_{90} - t_{10}$)
 - 2.4. Transformation time is the difference in time between the change of the component to be measured at the reference point and a system response of 50 % of the final reading (t_{50}) with the sampling probe being defined as the reference point

▼ M2

- 2.5. Step input time is the time at which there is a change in the parameter being measured.

Figure 6-11

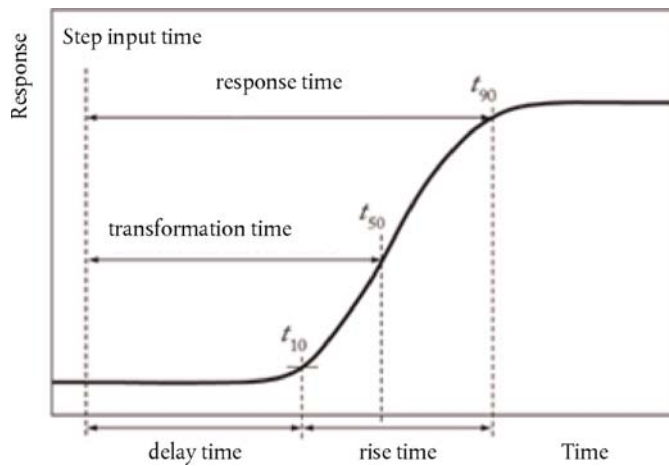
Illustration of system responses



ANNEX VII

Method for data evaluation and calculation

1. General requirements

Calculation of emissions shall be performed according to either section 2 (mass based calculations) or section 3 (molar based calculations). Mixture between the two methods is not permitted. It shall not be required to perform the calculations according to both section 2 and section 3.

The specific requirements for particle number (PN) measurement, where applicable, are laid down in Appendix 5.

1.1. General symbols

Section 2	Section 3	Unit	Quantity
	A	m^2	Area
	A_t	m^2	Venturi throat cross-sectional area
b, D_0	a_0	t.b.d. ⁽³⁾	y intercept of the regression line
A/F_{st}		—	Stoichiometric air to fuel ratio
	C	—	Coefficient
C_d	C_d	—	Discharge coefficient
	C_f	—	Flow coefficient
c	x	ppm, % vol	Concentration/mole fraction ($\mu\text{mol/mol} = \text{ppm}$)
c_d	⁽¹⁾	ppm, % vol	Concentration on dry basis
c_w	⁽¹⁾	ppm, % vol	Concentration on wet basis
c_b	⁽¹⁾	ppm, % vol	Background concentration
D	x_{dil}	—	Dilution factor ⁽²⁾
D_0		m^3/rev	PDP calibration intercept
d	d	m	Diameter
d_V		m	Throat diameter of venturi
e	e	g/kWh	Brake specific basis
e_{gas}	e_{gas}	g/kWh	Specific emission of gaseous components
e_{PM}	e_{PM}	g/kWh	Specific emission of particulates
E	$1 - PF$	%	Conversion efficiency ($PF = \text{Penetration fraction}$)
F_s		—	Stoichiometric factor
	f	Hz	Frequency
f_c		—	Carbon factor
	γ	—	Ratio of specific heats
H		g/kg	Absolute humidity
	K	—	Correction factor

▼ B

Section 2	Section 3	Unit	Quantity
K_V		$[(\sqrt{K} \cdot \text{m}^4 \cdot \text{s})/\text{kg}]$	CFV calibration function
k_f		$\text{m}^3/\text{kg fuel}$	Fuel specific factor
k_h		—	Humidity correction factor for NO_x , diesel engines
k_{Dr}	k_{Dr}	—	Downward adjustment factor
k_r	k_r	—	Multiplicative regeneration factor
k_{Ur}	k_{Ur}	—	Upward adjustment factor
$k_{w,a}$		—	Dry to wet correction factor for the intake air
$k_{w,d}$		—	Dry to wet correction factor for the dilution air
$k_{w,e}$		—	Dry to wet correction factor for the diluted exhaust gas
$k_{w,r}$		—	Dry to wet correction factor for the raw exhaust gas
μ	μ	$\text{kg}/(\text{m}\cdot\text{s})$	Dynamic viscosity
M	M	g/mol	Molar mass ⁽¹⁾
M_a	⁽¹⁾	g/mol	Molar mass of the intake air
M_e	v	g/mol	Molar mass of the exhaust gas
M_{gas}	M_{gas}	g/mol	Molar mass of gaseous components
m	m	kg	Mass
m	a_1	t.b.d. ⁽¹⁾	Slope of the regression line
	v	m^2/s	Kinematic viscosity
m_d	v	kg	Mass of the dilution air sample passed through the particulate sampling filters
m_{ed}	⁽¹⁾	kg	Total diluted exhaust gas mass over the cycle
m_{edf}	⁽¹⁾	kg	Mass of equivalent diluted exhaust gas over the test cycle
m_{ew}	⁽¹⁾	kg	Total exhaust gas mass over the cycle
m_f	⁽¹⁾	mg	Particulate sample mass collected
$m_{f,d}$	⁽¹⁾	mg	Particulate sample mass of the dilution air collected
m_{gas}	m_{gas}	g	Mass of gaseous emissions over the test cycle
m_{PM}	m_{PM}	g	Mass of particulate emissions over the test cycle
m_{se}	⁽¹⁾	kg	Exhaust gas sample mass over the test cycle
m_{sed}	⁽¹⁾	kg	Mass of diluted exhaust gas passing the dilution tunnel

▼B

Section 2	Section 3	Unit	Quantity
m_{sep}	(¹)	kg	Mass of diluted exhaust gas passing the particulate collection filters
m_{ssd}		kg	Mass of secondary dilution air
	N	—	Total number of a series
	n	mol	Amount of substance
	\dot{n}	mol/s	Amount of substance rate
n	f_n	min^{-1}	Engine rotational speed
n_p		r/s	PDP pump speed
P	P	kW	Power
p	p	kPa	Pressure
p_a		kPa	Dry atmospheric pressure
p_b		kPa	Total atmospheric pressure
p_d		kPa	Saturation vapour pressure of the dilution air
p_p	p_{abs}	kPa	Absolute pressure
p_r	$p_{\text{H}_2\text{O}}$	kPa	Water vapour pressure
p_s		kPa	Dry atmospheric pressure
$1 - E$	PF	%	Penetration fraction
qm	\dot{m}	kg/s	Mass rate
q_{mad}	$\dot{m}^{(1)}$	kg/s	Intake air mass flow rate on dry basis
q_{maw}	(¹)	kg/s	Intake air mass flow rate on wet basis
q_{mCe}	(¹)	kg/s	Carbon mass flow rate in the raw exhaust gas
q_{mCf}	(¹)	kg/s	Carbon mass flow rate into the engine
q_{mCp}	(¹)	kg/s	Carbon mass flow rate in the partial flow dilution system
q_{mdew}	(¹)	kg/s	Diluted exhaust gas mass flow rate on wet basis
q_{mdw}	(¹)	kg/s	Dilution air mass flow rate on wet basis
q_{medf}	(¹)	kg/s	Equivalent diluted exhaust gas mass flow rate on wet basis
q_{mew}	(¹)	kg/s	Exhaust gas mass flow rate on wet basis
q_{mex}	(¹)	kg/s	Sample mass flow rate extracted from dilution tunnel
q_{mf}	(¹)	kg/s	Fuel mass flow rate
q_{mp}	(¹)	kg/s	Sample flow of exhaust gas into partial flow dilution system
q_V	\dot{V}	m^3/s	Volume flow rate
$q_{V\text{CVS}}$	(¹)	m^3/s	CVS volume rate

▼ B

Section 2	Section 3	Unit	Quantity
q_{Vs}	(¹)	dm ³ /min	System flow rate of exhaust gas analyzer system
q_{Vt}	(¹)	cm ³ /min	Tracer gas flow rate
ρ	ρ	kg/m ³	Mass density
ρ_e		kg/m ³	Exhaust gas density
	r	—	Ratio of pressures
r_d	DR	—	Dilution ratio (¹)
	Ra	µm	Average surface roughness
RH		%	Relative humidity
r_D	β	m/m	Ratio of diameters (CVS systems)
r_p		—	Pressure ratio of SSV
Re	$Re^{\#}$	—	Reynolds number
	S	K	Sutherland constant
σ	σ	—	Standard deviation
T	T	°C	Temperature
	T	Nm	Engine torque
T_a		K	Absolute temperature
t	t	s	Time
Δt	Δt	s	Time interval
u		—	Ratio between densities of gas component and exhaust gas
V	V	m ³	Volume
q_V	\dot{V}	m ³ /s	Volume rate
V_0		m ³ /r	PDP gas volume pumped per revolution
W	W	kWh	Work
W_{act}	W_{act}	kWh	Actual cycle work of the test cycle
WF	WF	—	Weighting factor
w	w	g/g	Mass fraction
	\bar{x}	mol/mol	Flow-weighted mean concentration
X_0	K_s	s/rev	PDP calibration function
	y	—	Generic variable
\bar{y}	\bar{y}		Arithmetic mean
	Z	—	Compressibility factor

(¹) See subscripts; e.g.: \dot{m}_{air} for mass rate of dry air, \dot{m}_{fuel} for fuel mass rate, etc.

(²) Dilution ratio r_d in section 2 and DR in section 3: different symbols but same meaning and same equations. Dilution factor D in section 2 and x_{dil} in section 3: different symbols but same physical meaning; equation (7-124) shows the relationship between x_{dil} and DR .

(³) t.b.d.= to be defined.

▼ B

1.2. Subscripts

Section 2 (1)	Section 3	Quantity
act	act	Actual quantity
<i>i</i>		Instantaneous measurement (e.g.: 1 Hz)
	<i>i</i>	An individual of a series

(1) In section 2 the meaning of subscript is determined by the associated quantity; for example, the subscript 'd' can indicate a dry basis as in ' c_d = concentration on dry basis', dilution air as in ' p_d = saturation vapour pressure of the dilution air' or ' $k_{w,d}$ = dry to wet correction factor for the dilution air', dilution ratio as in ' r_d '.

1.3. Symbols and abbreviations for the chemical components (used also as a subscript)

Section 2	Section 3	Quantity
Ar	Ar	Argon
C1	C1	Carbon 1 equivalent hydrocarbon
CH ₄	CH ₄	Methane
C ₂ H ₆	C ₂ H ₆	Ethane
C ₃ H ₈	C ₃ H ₈	Propane
CO	CO	Carbon monoxide
CO ₂	CO ₂	Carbon dioxide
	H	Atomic hydrogen
	H ₂	Molecular hydrogen
HC	HC	Hydrocarbon
H ₂ O	H ₂ O	Water
	He	Helium
	N	Atomic nitrogen
	N ₂	Molecular nitrogen
NO _x	NO _x	Oxides of nitrogen
NO	NO	Nitric oxide
NO ₂	NO ₂	Nitrogen dioxide
	O	Atomic oxygen
PM	PM	Particulate matter
S	S	Sulphur

▼ B

1.4. Symbols and abbreviations for the fuel composition

Section 2 ⁽¹⁾	Section 3 ⁽²⁾	Quantity
w_C ⁽⁴⁾	w_C ⁽⁴⁾	Carbon content of fuel, mass fraction [g/g] or [% mass]
w_H	w_H	Hydrogen content of fuel, mass fraction [g/g] or [% mass]
w_N	w_N	Nitrogen content of fuel, mass fraction [g/g] or [% mass]
w_O	w_O	Oxygen content of fuel, mass fraction [g/g] or [% mass]
w_S	w_S	Sulphur content of fuel, mass fraction [g/g] or [% mass]
α	α	Atomic hydrogen-to-carbon ratio (H/C)
ε	β	Atomic oxygen-to-carbon ratio (O/C) ⁽³⁾
γ	γ	Atomic sulphur-to-carbon ratio (S/C)
δ	δ	Atomic nitrogen-to-carbon ratio (N/C)

⁽¹⁾ Referred to a fuel with chemical formula $CH_aO_eN_\delta S_\gamma$.

⁽²⁾ Referred to a fuel with chemical formula $CH_aO_\beta S_\gamma N_\delta$.

⁽³⁾ Attention should be paid to the different meaning of symbol β in the two emissions calculation sections: in section 2 it refers to a fuel having the chemical formula $CH_aS_\gamma N_\delta O_e$ (i.e. the formula $C_\beta H_a S_\gamma N_\delta O_e$ where $\beta = 1$, assuming one carbon atom per molecule), while in section 3 it refers to the oxygen-to-carbon ratio with $CH_aO_\beta S_\gamma N_\delta$. Then β of section 3 corresponds to ε of section 2.

⁽⁴⁾ Mass fraction w accompanied by the symbol of the chemical component as a subscript.

2. **Mass based emissions calculations****▼ M2**

2.1. Measurement of gaseous emissions in raw exhaust gas

▼ B

2.1.1. Discrete-mode NRSC tests

The emission rate of a gaseous emission $q_{m\text{gas},i}$ [g/h] for each mode i of the steady state test shall be calculated by multiplying the concentration of the gaseous emission with its respective flow, as follows:

▼ M2

$$q_{m\text{gas},i} = k_h \cdot k \cdot u_{\text{gas}} \cdot q_{m\text{ew},i} \cdot c_{\text{gas},i} \cdot 3\,600 \quad (7-1)$$

▼ B

where:

k = 1 for $c_{\text{gasr},w,i}$ in [ppm] and $k = 10\,000$ for $c_{\text{gasr},w,i}$ in [% vol]

k_h = NO_x correction factor [-], for NO_x emission calculation (see point 2.1.4)

u_{gas} = component specific factor or ratio between densities of gas component and exhaust gas [-]

$q_{m\text{ew},i}$ = exhaust gas mass flow rate in mode i on a wet basis [kg/s]

$c_{\text{gas},i}$ = emission concentration in the raw exhaust gas in mode i , on a wet basis [ppm] or [% vol]

▼ B

2.1.2. Transient (NRTC and LSI-NRTC) test cycles and RMC tests

The total mass per test of a gaseous emission m_{gas} [g/test] shall be calculated by multiplication of the time aligned instantaneous concentrations and exhaust gas flows and integration over the test cycle by means of equation (7-2):

$$m_{\text{gas}} = \frac{1}{f} \cdot k_{\text{h}} \cdot k \cdot u_{\text{gas}} \cdot \sum_{i=1}^N (q_{\text{mew},i} \cdot c_{\text{gas},i}) \quad (7-2)$$

where:

f = data sampling rate [Hz]

k_{h} = NO_x correction factor [-], only to be applied for the NO_x emission calculation

k = 1 for $c_{\text{gasr},w,i}$ in [ppm] and $k = 10\,000$ for $c_{\text{gasr},w,i}$ in [% vol]

u_{gas} = component specific factor [-] (see point 2.1.5)

N = number of measurements [-]

$q_{\text{mew},i}$ = instantaneous exhaust gas mass flow rate on a wet basis [kg/s]

$c_{\text{gas},i}$ = instantaneous emission concentration in the raw exhaust gas, on a wet basis [ppm] or [% vol]

2.1.3. Dry-to-wet concentration conversion

If the emissions are measured on a dry basis, the measured concentration c_{d} on dry basis shall be converted to the concentration c_{w} on a wet basis by means of equation (7-3):

$$c_{\text{w}} = k_{\text{w}} \cdot c_{\text{d}} \quad (7-3)$$

where:

k_{w} = dry-to-wet conversion factor [-]

c_{d} = emission concentration on a dry basis [ppm] or [% vol]

For complete combustion, the dry-to-wet conversion factor for raw exhaust gas is written as $k_{\text{w},a}$ [-] and shall be calculated by means of equation (7-4):

▼ M2

$$k_{\text{w},a} = \frac{\left(1 - \frac{1,2442 \cdot H_{\text{a}} + 111,19 \cdot w_{\text{H}} \cdot \frac{q_{\text{mf},i}}{q_{\text{mad},i}}}{773,4 + 1,2442 \cdot H_{\text{a}} + \frac{q_{\text{mf},i}}{q_{\text{mad},i}} \cdot k_{\text{f}} \cdot 1\,000}\right)}{\left(1 - \frac{p_{\text{r}}}{p_{\text{b}}}\right)} \quad (7-4)$$

▼ B

where:

H_{a} = intake air humidity [g H₂O/kg dry air]

$q_{\text{mf},i}$ = instantaneous fuel flow rate [kg/s]

$q_{\text{mad},i}$ = instantaneous dry intake air flow rate [kg/s]

p_{r} = water pressure after cooler [kPa]

p_{b} = total barometric pressure [kPa]

w_{H} = hydrogen content of the fuel [% mass]

k_{f} = combustion additional volume [m³/kg fuel]

▼B

with:

$$k_f = 0,055594 \cdot w_H + 0,0080021 \cdot w_N + 0,0070046 \cdot w_O \quad (7-5)$$

where:

w_H = hydrogen content of fuel [% mass]

w_N = nitrogen content of fuel [% mass]

w_O = oxygen content of fuel [% mass]

In equation (7-4), the ratio p_r/p_b may be assumed:

$$\frac{1}{\left(1 - \frac{p_r}{p_b}\right)} = 1,008 \quad (7-6)$$

For incomplete combustion (rich fuel air mixtures) and also for emission tests without direct air flow measurements, a second method of $k_{w,a}$ calculation is preferred:

$$k_{w,a} = \frac{\frac{1}{1+\alpha \cdot 0,005 \cdot (c_{CO_2} + c_{CO})} - K_{w1}}{1 - \frac{p_r}{p_b}} \quad (7-7)$$

where:

c_{CO_2} = concentration of CO₂ in the raw exhaust gas, on a dry basis [per cent vol]

c_{CO} = concentration of CO in the raw exhaust gas, on a dry basis [ppm]

p_r = water pressure after cooler [kPa]

p_b = total barometric pressure [kPa]

α = molar to carbon hydrogen ratio [-]

k_{w1} = intake air moisture [-]

$$k_{w1} = \frac{1,608 \cdot H_a}{1\,000 + 1,608 \cdot H_a} \quad (7-8)$$

2.1.4. NO_x correction for humidity and temperature

As the NO_x emission depends on ambient air conditions, the NO_x concentration shall be corrected for ambient air temperature and humidity with the factors $k_{h,D}$ or $k_{h,G}$ [-] given in equations (7-9) and (7-10). These factors are valid for a humidity range between 0 and 25 g H₂O/kg dry air.

(a) for compression-ignition engines

$$k_{h,D} = \frac{15,698 \times H_a}{1\,000} + 0,832 \quad (7-9)$$

(b) for spark ignition engines

$$k_{h,G} = 0,6272 + 44,030 \times 10^{-3} \times H_a - 0,862 \times 10^{-3} \times H_a^2 \quad (7-10)$$

where:

H_a = humidity of the intake air [g H₂O/kg dry air]

▼B2.1.5. Component specific factor u

Two calculation procedures are described in points 2.1.5.1 and 2.1.5.2. The procedure set out in point 2.1.5.1 is more straightforward, since it uses tabulated u values for the ratio between component and exhaust gas density. The procedure set out in point 2.1.5.2 is more accurate for fuel qualities that deviate from the specifications in Annex VIII, but requires elementary analysis of the fuel composition.

2.1.5.1. Tabulated values

Applying some simplifications (assumption on the λ value and on intake air conditions as shown in Table 7.1) to the equations set out in point 2.1.5.2, the resulting values for u_{gas} are given in Table 7.1.

Table 7.1

Raw exhaust gas u and component densities (for emission concentration expressed in ppm)

Fuel	ρ_e	Gas					
		NO _x	CO	HC	CO ₂	O ₂	CH ₄
				ρ_{gas} [kg/m ³]			
		2,053	1,250	(^a)	1,9636	1,4277	0,716
				u_{gas} (^b)			
Diesel (non-road gas-oil)	1,2943	0,001586	0,000966	0,000482	0,001517	0,001103	0,000553
Ethanol for dedicated compression ignition engines (ED95)	1,2768	0,001609	0,000980	0,000780	0,001539	0,001119	0,000561
Natural gas / bio-methane (^c)	1,2661	0,001621	0,000987	0,000528 (^d)	0,001551	0,001128	0,000565
Propane	1,2805	0,001603	0,000976	0,000512	0,001533	0,001115	0,000559
Butane	1,2832	0,001600	0,000974	0,000505	0,001530	0,001113	0,000558
LPG (^e)	1,2811	0,001602	0,000976	0,000510	0,001533	0,001115	0,000559
Petrol (E10)	1,2931	0,001587	0,000966	0,000499	0,001518	0,001104	0,000553
Ethanol (E85)	1,2797	0,001604	0,000977	0,000730	0,001534	0,001116	0,000559

(^a) Depending on fuel

(^b) At $\lambda = 2$, dry air, 273 K, 101,3 kPa

(^c) u accurate within 0,2 % for mass composition of: C = 66 – 76 %; H = 22 – 25 %; N = 0 – 12 %.

(^d) NMHC on the basis of CH_{2,93} (for total HC the u_{gas} coefficient of CH₄ shall be used).

(^e) u accurate within 0,2 % for mass composition of: C3 = 70 – 90 %; C4 = 10 – 30 %.

2.1.5.2. Calculated values

The component specific factor, $u_{\text{gas},i}$, may be calculated by the density ratio of the component and the exhaust gas or alternatively by the corresponding ratio of molar masses [equations (7-11) or (7-12)]:

$$u_{\text{gas},i} = M_{\text{gas}} / (M_{e,i} \cdot 1\,000) \quad (7-11)$$

or

▼ B

$$u_{\text{gas},i} = \rho_{\text{gas}} / (\rho_{e,i} \cdot 1\,000) \quad (7-12)$$

where:

M_{gas} = molar mass of the gas component [g/mol]

$M_{e,i}$ = instantaneous molar mass of the wet raw exhaust gas [g/mol]

ρ_{gas} = density of the gas component [kg/m³]

$\rho_{e,i}$ = instantaneous density of the wet raw exhaust gas [kg/m³]

The molar mass of the exhaust gas, $M_{e,i}$ shall be derived for a general fuel composition $\text{CH}_\alpha\text{O}_\varepsilon\text{N}_\delta\text{S}_\gamma$ under the assumption of complete combustion, and shall be calculated by means of equation (7-13):

▼ M2

$$M_{e,i} = \frac{1 + \frac{q_{mf,i}}{q_{maw,i}}}{\frac{q_{mf,i}}{q_{maw,i}} \cdot \frac{\frac{\alpha}{4} + \frac{\varepsilon}{2} + \frac{\delta}{2}}{12,011 + 1,00794 \cdot \alpha + 15,9994 \cdot \varepsilon + 14,0067 \cdot \delta + 32,065 \cdot \gamma} + \frac{H_a \cdot 10^{-3}}{2 \times 1,00794 + 15,9994 + M_a}}{1 + H_a \cdot 10^{-3}} \quad (7-13)$$

▼ B

Where:

$q_{mf,i}$ = instantaneous fuel mass flow rate on wet basis [kg/s]

$q_{maw,i}$ = instantaneous intake air mass flow rate on wet basis [kg/s]

α = molar hydrogen-to-carbon ratio [-]

δ = molar nitrogen-to-carbon ratio [-]

ε = molar oxygen-to-carbon ratio [-]

γ = atomic sulphur-to-carbon ratio [-]

H_a = intake air humidity [g H₂O/kg dry air]

M_a = dry intake air molecular mass = 28,965 g/mol

The instantaneous raw exhaust gas density $\rho_{e,i}$ [kg/m³] shall be calculated by means of equation (7-14):

$$\rho_{e,i} = \frac{1\,000 + H_a + 1\,000 \cdot (q_{mf,i}/q_{mad,i})}{773,4 + 1,2434 \cdot H_a + k_f \cdot 1\,000 \cdot (q_{mf,i}/q_{mad,i})} \quad (7-14)$$

where:

$q_{mf,i}$ = instantaneous fuel mass flow rate [kg/s]

$q_{mad,i}$ = instantaneous dry intake air mass flow rate [kg/s]

H_a = intake air humidity [g H₂O/kg dry air]

k_f = combustion additional volume [m³/kg fuel] [see equation (7-5)]

▼ B

2.1.6.1. Air and fuel measurement method

The method involves measurement of the air flow and the fuel flow with suitable flowmeters. The instantaneous exhaust gas flow $q_{mew,i}$ [kg/s] shall be calculated by means of equation (7-15):

$$q_{mew,i} = q_{maw,i} + q_{mf,i} \quad (7-15)$$

where:

$q_{maw,i}$ = instantaneous intake air mass flow rate [kg/s]

$q_{mf,i}$ = instantaneous fuel mass flow rate [kg/s]

2.1.6.2. Tracer measurement method

This involves measurement of the concentration of a tracer gas in the exhaust gas. The instantaneous exhaust gas flow $q_{mew,i}$ [kg/s] shall be calculated by means of equation (7-16):

$$q_{mew,i} = \frac{q_{Vt} \cdot \rho_e}{10^{-6} \cdot (c_{mix,i} - c_b)} \quad (7-16)$$

where:

q_{Vt} = tracer gas flow rate [m³/s]

$c_{mix,i}$ = instantaneous concentration of the tracer gas after mixing [ppm]

ρ_e = density of the raw exhaust gas [kg/m³]

c_b = background concentration of the tracer gas in the intake air [ppm]

The background concentration of the tracer gas c_b may be determined by averaging the background concentration measured immediately before the test run and after the test run. When the background concentration is less than 1 % of the concentration of the tracer gas after mixing $c_{mix,i}$ at maximum exhaust gas flow, the background concentration may be neglected.

2.1.6.3. Air flow and air to fuel ratio measurement method

This involves exhaust gas mass calculation from the air flow and the air to fuel ratio. The instantaneous exhaust gas mass flow $q_{mew,i}$ [kg/s] shall be calculated by means of equation (7-17):

$$q_{mew,i} = q_{maw,i} \cdot \left(1 + \frac{1}{A/F_{st} \cdot \lambda_i} \right) \quad (7-17)$$

with:

$$A/F_{st} = \frac{138,0 \cdot \left(1 + \frac{\alpha}{4} - \frac{\varepsilon}{2} + \gamma \right)}{12,011 + 1,00794 \cdot \alpha + 15,9994 \cdot \varepsilon + 14,0067 \cdot \delta + 32,065 \cdot \gamma} \quad (7-18)$$

$$\lambda_i = \frac{\left(100 - \frac{c_{COd} \cdot 10^{-4}}{2} - c_{HCw} \cdot 10^{-4} \right) + \left(\frac{\alpha}{4} \cdot \frac{1 - \frac{2 \cdot c_{COd} \cdot 10^{-4}}{3,5 \cdot c_{CO2d}} - \frac{\varepsilon}{2} - \frac{\delta}{2}}{1 + \frac{c_{COd} \cdot 10^{-4}}{3,5 \cdot c_{CO2d}}} \right) \cdot (c_{CO2d} + c_{COd} \cdot 10^{-4})}{4,764 \cdot \left(1 + \frac{\alpha}{4} - \frac{\varepsilon}{2} + \gamma \right) \cdot (c_{CO2d} + c_{COd} \cdot 10^{-4} + c_{HCw} \cdot 10^{-4})} \quad (7-19)$$

where:

$q_{maw,i}$ = wet intake air mass flow rate [kg/s]

A/F_{st} = stoichiometric air-to-fuel ratio [-]

▼ B

- λ_i = instantaneous excess air ratio [-]
- c_{COd} = concentration of CO in the raw exhaust gas on a dry basis [ppm]
- c_{CO2d} = concentration of CO₂ in the raw exhaust gas on a dry basis [per cent]
- c_{HCw} = concentration of HC in the raw exhaust gas on a wet basis [ppm C1]
- α = molar hydrogen-to-carbon ratio [-]
- δ = molar nitrogen-to-carbon ratio [-]
- ε = molar oxygen-to-carbon ratio [-]
- γ = atomic sulphur-to-carbon ratio [-]

2.1.6.4. Carbon balance method, 1-step procedure

The following 1-step formula set out in equation (7-20) can be used for the calculation of the wet exhaust gas mass flow rate $q_{\text{mew},i}$ [kg/s]:

$$q_{\text{mew},i} = q_{\text{mf},i} \cdot \left[\frac{1,4 \cdot w_{\text{C}}}{(1,0828 \cdot w_{\text{C}} + k_{\text{fd}} \cdot f_{\text{c}}) f_{\text{c}}} \left(1 + \frac{H_{\text{a}}}{1\,000} \right) + 1 \right] \quad (7-20)$$

with the carbon factor f_{c} [-] given by:

$$f_{\text{c}} = 0,5441 \cdot (c_{\text{CO2d}} - c_{\text{CO2d,a}}) + \frac{c_{\text{COd}}}{18\,522} + \frac{c_{\text{HCw}}}{17\,355} \quad (7-21)$$

Where:

- $q_{\text{mf},i}$ = instantaneous fuel mass flow rate [kg/s]

▼ M2

- w_{C} = carbon content of fuel [% mass] (see equation (7-82) of point 3.3.3.1 or table 7.3)

▼ B

- H_{a} = intake air humidity [g H₂O/kg dry air]
- k_{fd} = combustion additional volume on a dry basis [m³/kg fuel]
- c_{CO2d} = dry CO₂ concentration in the raw exhaust gas [%]
- $c_{\text{CO2d,a}}$ = dry CO₂ concentration in the ambient air [%]
- c_{COd} = dry CO concentration in the raw exhaust gas [ppm]
- c_{HCw} = wet HC concentration in the raw exhaust gas [ppm]

and factor k_{fd} [m³/kg fuel] that is calculated by means of equation (7-22) on a dry basis by subtracting the water formed by combustion from k_{f} :

$$k_{\text{fd}} = k_{\text{f}} - 0,11118 \cdot w_{\text{H}} \quad (7-22)$$

where:

- k_{f} = fuel specific factor of equation (7-5) [m³/kg fuel]

- w_{H} = hydrogen content of fuel [% mass]

▼ B

2.2. Diluted gaseous emissions

2.2.1. Mass of the gaseous emissions

The exhaust gas mass flow rate shall be measured with a constant volume sampling (CVS) system, which may use a positive displacement pump (PDP), a critical flow venturi (CFV) or a subsonic venturi (SSV).

For systems with constant mass flow (i.e. with heat exchanger), the mass of the pollutants m_{gas} [g/test] shall be determined by means of equation (7-23):

$$m_{\text{gas}} = k_{\text{h}} \cdot k \cdot u_{\text{gas}} \cdot c_{\text{gas}} \cdot m_{\text{ed}} \quad (7-23)$$

where:

u_{gas} is the ratio between density of exhaust gas component and density of air, as given in Table 7.2 or calculated by means of equation (7-34) [-]

c_{gas} = mean background corrected concentration of the component on a wet basis [ppm] or [% vol] respectively

k_{h} = NO_x correction factor [-], only to be applied for the NO_x emission calculation

$k = 1$ for $c_{\text{gasr,w},i}$ in [ppm], $k = 10\,000$ for $c_{\text{gasr,w},i}$ in [% vol]

m_{ed} = total diluted exhaust gas mass over the cycle [kg/test]

For systems with flow compensation (without heat exchanger), the mass of the pollutants m_{gas} [g/test] shall be determined by calculation of the instantaneous mass emissions, by integration and by background correction by means of equation (7-24):

$$m_{\text{gas}} = k_{\text{h}} \cdot k \cdot \left(\sum_{i=1}^N [(m_{\text{ed},i} \cdot c_{\text{e}} \cdot u_{\text{gas}})] - \left[(m_{\text{ed}} \cdot c_{\text{d}} \cdot \left(1 - \frac{1}{D}\right) \cdot u_{\text{gas}}) \right] \right) \quad (7-24)$$

Where:

c_{e} = emission concentration in the diluted exhaust gas, on a wet basis [ppm] or [% vol]

c_{d} = emission concentration in the dilution air, on a wet basis [ppm] or [% vol]

$m_{\text{ed},i}$ = mass of the diluted exhaust gas during time interval i [kg]

m_{ed} = total mass of diluted exhaust gas over the cycle [kg]

u_{gas} = tabulated value from Table 7.2 [-]

D = dilution factor [see equation (7-28) of point 2.2.2.2] [-]

k_{h} = NO_x correction factor [-], only to be applied for the NO_x emission calculation

$k = 1$ for c in [ppm], $k = 10\,000$ for c in [% vol]

The concentrations c_{gas} , c_{e} and c_{d} can be either values measured in a batch sample (bag, but not allowed for NO_x and HC) or be averaged by integration from continuous measurements. Also $m_{\text{ed},i}$ has to be averaged by integration over the test cycle.

The following equations show how the needed quantities (c_{e} , u_{gas} and m_{ed}) shall be calculated.

▼B

2.2.2. Dry-to-wet concentration conversion

All concentrations set out in point 2.2.1 measured dry shall be converted to a wet basis by means of equation (7-3).

2.2.2.1. Diluted exhaust gas

Dry concentrations shall be converted to wet concentrations by means of one of the following two equations [(7-25) or (7-26)] applied to equation:

$$k_{w,e} = \left[\left(1 - \frac{\alpha \cdot c_{CO_2w}}{200} \right) - k_{w2} \right] \cdot 1,008 \quad (7-25)$$

or

$$k_{w,e} = \left(\frac{(1 - k_{w2})}{1 + \frac{\alpha \cdot c_{CO_2d}}{200}} \right) \cdot 1,008 \quad (7-26)$$

where:

α = molar hydrogen to carbon ratio of the fuel [-]

c_{CO_2w} = concentration of CO₂ in the diluted exhaust gas on a wet basis [per cent vol]

c_{CO_2d} = concentration of CO₂ in the diluted exhaust gas on a dry basis [per cent vol]

The dry to wet correction factor k_{w2} takes into consideration the water content of both intake air and dilution air and shall be calculated by means of equation (7-27):

$$k_{w2} = \frac{1,608 \cdot \left[H_d \cdot \left(1 - \frac{1}{D} \right) + H_a \cdot \left(\frac{1}{D} \right) \right]}{1\,000 + \left\{ 1,608 \cdot \left[H_d \cdot \left(1 - \frac{1}{D} \right) + H_a \cdot \left(\frac{1}{D} \right) \right] \right\}} \quad (7-27)$$

where:

H_a = intake air humidity [g H₂O/kg dry air]

H_d = dilution air humidity [g H₂O/kg dry air]

D = dilution factor [see equation (7-28) of point 2.2.2.2] [-]

2.2.2.2. Dilution factor

The dilution factor D [-] (which is necessary for the background correction and the k_{w2} calculation) shall be calculated by means of equation (7-28):

$$D = \frac{F_s}{c_{CO_2,e} + (c_{HC,e} + c_{CO,e}) \cdot 10^{-4}} \quad (7-28)$$

where:

F_S = stoichiometric factor [-]

$c_{CO_2,e}$ = concentration of CO₂ in the diluted exhaust gas on a wet basis [per cent vol]

$c_{HC,e}$ = concentration of HC in the diluted exhaust gas on a wet basis [ppm C1]

$c_{CO,e}$ = concentration of CO in the diluted exhaust gas on a wet basis [ppm]

▼ B

The stoichiometric factor shall be calculated by means of equation (7-29):

$$F_s = 100 \cdot \frac{1}{1 + \frac{\alpha}{2} + 3,76 \cdot \left(1 + \frac{\alpha}{4}\right)} \quad (7-29)$$

Where:

α = molar hydrogen to carbon ratio in the fuel [-]

Alternatively, if the fuel composition is not known, the following stoichiometric factors may be used:

F_S (diesel) = 13,4

F_S (LPG) = 11,6

F_S (NG) = 9,5

F_S (E10) = 13,3

F_S (E85) = 11,5

If a direct measurement is made of the exhaust gas flow, the dilution factor D [-] may be calculated by means of equation (7-30):

$$D = \frac{q_{VCVS}}{q_{Vew}} \quad (7-30)$$

Where:

q_{VCVS} is the volumetric flow rate of diluted exhaust gas [m^3/s]

q_{Vew} = volumetric flow rate of raw exhaust gas [m^3/s]

2.2.2.3. Dilution air

$$k_{w,d} = (1 - k_{w3}) \cdot 1,008 \quad (7-31)$$

with

$$k_{w3} = \frac{1,608 \cdot H_d}{1\,000 + 1,608 \cdot H_d} \quad (7-32)$$

where:

H_d = dilution air humidity [g $\text{H}_2\text{O}/\text{kg}$ dry air]

2.2.2.4. Determination of the background corrected concentration

The average background concentration of the gaseous pollutants in the dilution air shall be subtracted from measured concentrations to get the net concentrations of the pollutants. The average values of the background concentrations can be determined by the sample bag method or by continuous measurement with integration. Equation (7-33) shall be used:

$$c_{\text{gas}} = c_{\text{gas,e}} - c_d \cdot \left(1 - \frac{1}{D}\right) \quad (7-33)$$

Where:

c_{gas} = net concentration of the gaseous pollutant [ppm] or [% vol]

$c_{\text{gas,e}}$ = emission concentration in the diluted exhaust gas, on a wet basis [ppm] or [% vol]

c_d = emission concentration in the dilution air, on a wet basis [ppm] or [% vol]

D = dilution factor [see equation (7-28) of point 2.2.2.2] [-]

▼B2.2.3. Component specific factor u

The component specific factor u_{gas} of diluted gas can either be calculated by means of equation (7-34) or be taken from Table 7.2; in Table 7.2 the density of the diluted exhaust gas has been assumed equal to air density.

$$u = \frac{M_{\text{gas}}}{M_{\text{d,w}} \cdot 1\,000} = \frac{M_{\text{gas}}}{\left[M_{\text{da,w}} \cdot \left(1 - \frac{1}{D} \right) + M_{\text{r,w}} \cdot \left(\frac{1}{D} \right) \right] \cdot 1\,000} \quad (7-34)$$

Where:

M_{gas} = molar mass of the gas component [g/mol]

$M_{\text{d,w}}$ = molar mass of diluted exhaust gas [g/mol]

▼M2

$M_{\text{da,w}}$ = molar mass of dilution air [g/mol] (see equation (7-144) of point 3.9.3)

$M_{\text{r,w}}$ = molar mass of raw exhaust gas [g/mol] (see Appendix 2 point (5))

▼B

D = dilution factor [see equation (7-28) of point 2.2.2.2] [-]

Table 7.2

Diluted exhaust gas u values (for emission concentration expressed in ppm) and component densities

Fuel	ρ_e	Gas					
		NO _x	CO	HC	CO ₂	O ₂	CH ₄
				ρ_{gas} [kg/m ³]			
		2,053	1,250	(¹)	1,9636	1,4277	0,716
				u_{gas} (²)			
Diesel (non-road gas-oil)	1,2943	0,001586	0,000966	0,000482	0,001517	0,001103	0,000553
Ethanol for dedicated compression ignition engines (ED95)	1,2768	0,001609	0,000980	0,000780	0,001539	0,001119	0,000561
Natural gas / bio-methane (³)	1,2661	0,001621	0,000987	0,000528 (⁴)	0,001551	0,001128	0,000565
Propane	1,2805	0,001603	0,000976	0,000512	0,001533	0,001115	0,000559
Butane	1,2832	0,001600	0,000974	0,000505	0,001530	0,001113	0,000558
LPG (⁵)	1,2811	0,001602	0,000976	0,000510	0,001533	0,001115	0,000559
Petrol (E10)	1,2931	0,001587	0,000966	0,000499	0,001518	0,001104	0,000553
Ethanol (E85)	1,2797	0,001604	0,000977	0,000730	0,001534	0,001116	0,000559

(¹) Depending on fuel.

(²) At $\lambda = 2$, dry air, 273 K, 101,3 kPa.

(³) u accurate within 0,2 % for mass composition of: C = 66 – 76 %; H = 22 – 25 %; N = 0 – 12 %.

(⁴) NMHC on the basis of CH_{2,93} (for total HC the u_{gas} coefficient of CH₄ shall be used).

(⁵) u accurate within 0,2 % for mass composition of: C3 = 70 – 90 %; C4 = 10 – 30 %.

2.2.4. Exhaust gas mass flow calculation

2.2.4.1. PDP-CVS system

The mass of the diluted exhaust gas [kg/test] over the cycle shall be calculated by means of equation (7-35), if the temperature of the diluted exhaust gas m_{ed} is kept within ± 6 K over the cycle by using a heat exchanger:

▼ B

$$m_{ed} = 1,293 \cdot V_0 \cdot n_p \cdot \frac{P_p}{101,325} \cdot \frac{273,15}{T} \quad (7-35)$$

where:

V_0 = volume of gas pumped per revolution under test conditions [m³/rev]

n_p = total revolutions of pump per test [rev/test]

p_p = absolute pressure at pump inlet [kPa]

\bar{T} = average temperature of the diluted exhaust gas at pump inlet [K]

1,293 kg/m³ = air density at 273,15 K and 101,325 kPa

If a system with flow compensation is used (i.e. without heat exchanger), the mass of the diluted exhaust gas $m_{ed,i}$ [kg] during the time interval shall be calculated by means of equation (7-36):

$$m_{ed,i} = 1,293 \cdot V_0 \cdot n_{p,i} \cdot \frac{P_p}{101,325} \cdot \frac{273,15}{T} \quad (7-36)$$

where:

V_0 = volume of gas pumped per revolution under test conditions [m³/rev]

p_p = absolute pressure at pump inlet [kPa]

$n_{p,i}$ = total revolutions of pump per time interval i [rev/Δt]

\bar{T} = average temperature of the diluted exhaust gas at pump inlet [K]

1,293 kg/m³ = air density at 273,15 K and 101,325 kPa

2.2.4.2. CFV-CVS system

The mass flow over the cycle m_{ed} [g/test] shall be calculated by means of equation (7-37), if the temperature of the diluted exhaust gas is kept within ± 11 K over the cycle by using a heat exchanger:

$$m_{ed} = \frac{1,293 \cdot t \cdot K_V \cdot p_p}{T^{0,5}} \quad (7-37)$$

Where:

t = cycle time [s]

K_V = calibration coefficient of the critical flow venturi for standard conditions [(√K · m⁴ · s)/kg]

p_p = absolute pressure at venturi inlet [kPa]

T = absolute temperature at venturi inlet [K]

1,293 kg/m³ = air density at 273,15 K and 101,325 kPa

If a system with flow compensation is used (i.e. without heat exchanger), the mass of the diluted exhaust gas $m_{ed,i}$ [kg] during the time interval shall be calculated by means of equation (7-38):

$$m_{ed,i} = \frac{1,293 \cdot \Delta t_i \cdot K_V \cdot p_p}{T^{0,5}} \quad (7-38)$$

▼ B

where:

- Δt_i = time interval of the test [s]
- K_V = calibration coefficient of the critical flow venturi for standard conditions $[(\sqrt{K} \cdot \text{m}^4 \cdot \text{s})/\text{kg}]$
- p_p = absolute pressure at venturi inlet [kPa]
- T = absolute temperature at venturi inlet [K]
- $1,293 \text{ kg/m}^3$ = air density at 273,15 K and 101,325 kPa

2.2.4.3. SSV-CVS system

The diluted exhaust gas mass over the cycle m_{ed} [kg/test] shall be calculated by means of equation (7-39), if the temperature of the diluted exhaust gas is kept within ± 11 K over the cycle by using a heat exchanger:

$$m_{ed} = 1,293 \cdot q_{VSSV} \cdot \Delta t \quad (7-39)$$

Where:

- $1,293 \text{ kg/m}^3$ = air density at 273,15 K and 101,325 kPa
- Δt = cycle time [s]
- q_{VSSV} = air flow rate at standard conditions (101,325 kPa, 273,15 K) [m^3/s]

with

$$q_{VSSV} = \frac{A_0}{60} d_V^2 C_d P_p \sqrt{\left[\frac{1}{T} (r_p^{1,4286} - r_p^{1,7143}) \cdot \left(\frac{1}{1 - r_D^4 r_p^{1,4286}} \right) \right]} \quad (7-40)$$

Where:

- A_0 = collection of constants and units conversions = 0,0056940 $\left[\frac{\text{m}^3}{\text{min}} \cdot \frac{\text{K}^{\frac{1}{2}}}{\text{kPa}} \cdot \frac{1}{\text{mm}^2} \right]$
- d_V = diameter of the SSV throat [mm]
- C_d = discharge coefficient of the SSV [-]
- p_p = absolute pressure at venturi inlet [kPa]
- T_{in} = temperature at the venturi inlet [K]
- r_p = ratio of the SSV throat to inlet absolute static pressure, $\left(1 - \frac{\Delta P}{P_a} \right)$ [-]
- r_D = ratio of the SSV throat diameter to the inlet pipe inner diameter $\frac{d}{D}$ [-]

If a system with flow compensation is used (i.e. without heat exchanger), the mass of the diluted exhaust gas $m_{ed,i}$ [kg] during the time interval shall be calculated by means of equation (7-41):

$$m_{ed,i} = 1,293 \cdot q_{VSSV} \cdot \Delta t_i \quad (7-41)$$

Where:

- $1,293 \text{ kg/m}^3$ = air density at 273,15 K and 101,325 kPa
- Δt_i = time interval [s]
- q_{VSSV} = volumetric flow rate of the SSV [m^3/s]

▼ B

2.3. Calculation of particulate emission

▼ M2

2.3.1. Transient (NRTC and LSI-NRTC) test cycles and RMC

The particulate mass shall be calculated after buoyancy correction of the particulate sample mass in accordance with point 8.1.13.2.5 of Annex VI.

▼ B

2.3.1.1. Partial flow dilution system

2.3.1.1.1. Calculation based on sample ratio

The particulate emission over the cycle m_{PM} [g] shall be calculated by means of equation (7-42):

$$m_{PM} = \frac{m_f}{r_s \cdot 1\,000} \quad (7-42)$$

where:

m_f = particulate mass sampled over the cycle [mg]

r_s = average sample ratio over the test cycle [-]

with:

$$r_s = \frac{m_{se}}{m_{ew}} \cdot \frac{m_{sep}}{m_{sed}} \quad (7-43)$$

Where:

m_{se} = sample mass of raw exhaust gas over the cycle [kg]

m_{ew} = total mass of raw exhaust gas over the cycle [kg]

m_{sep} = mass of diluted exhaust gas passing the particulate collection filters [kg]

m_{sed} = mass of diluted exhaust gas passing the dilution tunnel [kg]

In case of the total sampling type system, m_{sep} and m_{sed} are identical.

2.3.1.1.2. Calculation based on dilution ratio

The particulate emission over the cycle m_{PM} [g] shall be calculated by means of equation (7-44):

$$m_{PM} = \frac{m_f}{m_{sep}} \cdot \frac{m_{edf}}{1\,000} \quad (7-44)$$

Where:

m_f = particulate mass sampled over the cycle [mg]

m_{sep} = mass of diluted exhaust gas passing the particulate collection filters [kg]

m_{edf} = mass of equivalent diluted exhaust gas over the cycle [kg]

The total mass of equivalent diluted exhaust gas mass over the cycle m_{edf} [kg] shall be determined by means of equation (7-45):

$$m_{edf} = \frac{1}{f} \cdot \sum_{i=1}^N q_{medf,i} \quad (7-45)$$

With:

▼ M2

$$q_{medf,i} = q_{mew,i} \cdot r_{d,i} \quad (7-46)$$

▼ B

$$r_{d,i} = \frac{q_{mdew,i}}{q_{mdew,i} - q_{mdw,i}} \quad (7-47)$$

▼ B

Where:

$q_{medf,i}$ = instantaneous equivalent diluted exhaust gas mass flow rate [kg/s]

$q_{mew,i}$ = instantaneous exhaust gas mass flow rate on a wet basis [kg/s]

$r_{d,i}$ = instantaneous dilution ratio [-]

$q_{mdew,i}$ = instantaneous diluted exhaust gas mass flow rate on a wet basis [kg/s]

$q_{mdw,i}$ = instantaneous dilution air mass flow rate [kg/s]

f = data sampling rate [Hz]

N = number of measurements [-]

2.3.1.2. Full flow dilution system

The mass emission shall be calculated by means of equation (7-48):

$$m_{PM} = \frac{m_f}{m_{sep}} \cdot \frac{m_{ed}}{1\,000} \quad (7-48)$$

where:

m_f = is the particulate mass sampled over the cycle [mg]

m_{sep} = is the mass of diluted exhaust gas passing the particulate collection filters [kg]

m_{ed} = is the mass of diluted exhaust gas over the cycle [kg]

with

$$m_{sep} = m_{set} - m_{ssd} \quad (7-49)$$

Where:

m_{set} = mass of double diluted exhaust gas through particulate filter [kg]

m_{ssd} = mass of secondary dilution air [kg]

2.3.1.2.1. Background correction

The particulate mass $m_{PM,c}$ [g] may be background corrected by means of equation (7-50):

$$m_{PM,c} = \left\{ \frac{m_f}{m_{sep}} - \left[\frac{m_b}{m_{sd}} \cdot \left(1 - \frac{1}{D} \right) \right] \right\} \cdot \frac{m_{ed}}{1\,000} \quad (7-50)$$

Where:

m_f = particulate mass sampled over the cycle [mg]

m_{sep} = mass of diluted exhaust gas passing the particulate collection filters [kg]

m_{sd} = mass of dilution air sampled by background particulate sampler [kg]

m_b = mass of collected background particulates of dilution air [mg]

m_{ed} = mass of diluted exhaust gas over the cycle [kg]

D = dilution factor [see equation (7-28) of point 2.2.2.2] [-]

▼B

2.3.2. Calculation for discrete-mode NRSC

2.3.2.1. Dilution system

All calculations shall be based upon the average values of the individual modes i during the sampling period.

- (a) For partial-flow dilution, the equivalent mass flow of diluted exhaust gas shall be determined by means of equation (7-51) and the system with flow measurement shown in Figure 9.2:

$$q_{medf} = q_{mew} \cdot r_d \quad (7-51)$$

$$r_d = \frac{q_{mdew}}{q_{mdew} - q_{mdw}} \quad (7-52)$$

Where:

q_{medf} = equivalent diluted exhaust gas mass flow rate [kg/s]

q_{mew} = exhaust gas mass flow rate on a wet basis [kg/s]

r_d = dilution ratio [-]

q_{mdew} = diluted exhaust gas mass flow rate on a wet basis [kg/s]

q_{mdw} = dilution air mass flow rate [kg/s]

- (b) For full-flow dilution systems q_{mdew} is used as q_{medf} .

2.3.2.2. Calculation of the particulate mass flow rate

The particulate emission flow rate over the cycle q_{mPM} [g/h] shall be calculated by means of equations (7-53), (7-56), (7-57) or (7-58):

- (a) For the single-filter method

$$q_{mPM} = \frac{m_f}{m_{sep}} \cdot \overline{q_{medf}} \cdot \frac{3\,600}{1\,000} \quad (7-53)$$

$$\overline{q_{medf}} = \sum_{i=1}^N q_{medfi} \cdot WF_i \quad (7-54)$$

$$m_{sep} = \sum_{i=1}^N m_{sepi} \quad (7-55)$$

Where:

q_{mPM} = particulate mass flow rate [g/h]

m_f = particulate mass sampled over the cycle [mg]

$\overline{q_{medf}}$ = average equivalent diluted exhaust gas mass flow rate on wet basis [kg/s]

q_{medfi} = equivalent diluted exhaust gas mass flow rate on wet basis at mode i [kg/s]

WF_i = weighting factor for the mode i [-]

m_{sep} = mass of diluted exhaust gas passing the particulate collection filters [kg]

m_{sepi} = mass of diluted exhaust gas sample passed through the particulate sampling filter at mode i [kg]

N = number of measurements [-]

▼ B

(b) For the multiple-filter method

$$q_{mPMi} = \frac{m_{fi}}{m_{sepi}} \cdot q_{medfi} \cdot \frac{3\,600}{1\,000} \quad (7-56)$$

Where:

q_{mPMi} = particulate mass flow rate for the mode i [g/h]

m_{fi} = particulate sample mass collected at mode i [mg]

q_{medfi} = equivalent diluted exhaust gas mass flow rate on wet basis at mode i [kg/s]

m_{sepi} = mass of diluted exhaust gas sample passed through the particulate sampling filter at mode i [kg]

The PM mass is determined over the test cycle by summation of the average values of the individual modes i during the sampling period.

The particulate mass flow rate q_{mPM} [g/h] or q_{mPMi} [g/h] may be background corrected as follows:

(c) For the single-filter method

$$q_{mPM} = \left\{ \frac{m_f}{m_{sep}} - \left[\frac{m_{f,d}}{m_d} \cdot \sum_{i=1}^N \left(1 - \frac{1}{D_i} \right) \cdot WF_i \right] \right\} \cdot \overline{q_{medf}} \cdot \frac{3\,600}{1\,000} \quad (7-57)$$

Where:

q_{mPM} = particulate mass flow rate [g/h]

m_f = particulate sample mass collected [mg]

m_{sep} = mass of diluted exhaust gas sample passed through the particulate sampling filter [kg]

$m_{f,d}$ = particulate sample mass of the dilution air collected [mg]

m_d = mass of the dilution air sample passed through the particulate sampling filters [kg]

D_i = dilution factor at mode i [see equation (7-28) of point 2.2.2.2] [-]

WF_i = weighting factor for the mode i [-]

$\overline{q_{medf}}$ = average equivalent diluted exhaust gas mass flow rate on wet basis [kg/s]

(d) For the multiple-filter method

$$q_{mPMi} = \left\{ \frac{m_{fi}}{m_{sepi}} - \left[\frac{m_{f,d}}{m_d} \cdot \left(1 - \frac{1}{D_i} \right) \right] \right\} \cdot \overline{q_{medfi}} \cdot \frac{3\,600}{1\,000} \quad (7-58)$$

Where:

q_{mPMi} = particulate mass flow rate at mode i [g/h]

m_{fi} = particulate sample mass collected at mode i [mg]

m_{sepi} = mass of diluted exhaust gas sample passed through the particulate sampling filter at mode i [kg]

$m_{f,d}$ = particulate sample mass of the dilution air collected [mg]

m_d = mass of the dilution air sample passed through the particulate sampling filters [kg]

▼ B

D = dilution factor [see equation (7-28) of point 2.2.2.2] [-]

q_{medfi} = equivalent diluted exhaust gas mass flow rate on wet basis at mode i [kg/s]

If more than one measurement is made, $m_{f,d}/m_d$ shall be replaced with $m_{f,d}/m_d$.

2.4. Cycle work and specific emissions

2.4.1. Gaseous emissions

2.4.1.1. Transient (NRTC and LSI-NRTC) test cycles and RMC

Reference is made to points 2.1 and 2.2 for raw and diluted exhaust gas respectively. The resulting values for power P [kW] shall be integrated over a test interval. The total work W_{act} [kWh] is calculated by means of equation (7-59):

▼ M2

$$W_{act} = \sum_{i=1}^N P_i \cdot \Delta t_i = \frac{1}{f} \cdot \frac{1}{3\,600} \cdot \frac{1}{10^3} \cdot \frac{2 \cdot \pi}{60} \cdot \sum_{i=1}^N (n_i \cdot T_i) \quad (7-59)$$

▼ B

Where:

P_i = instantaneous engine power [kW]

n_i = instantaneous engine speed [rpm]

T_i = instantaneous engine torque [Nm]

W_{act} = actual cycle work [kWh]

f = data sampling rate [Hz]

N = number of measurements [-]

▼ M2

Δt_i = the measurement interval [s]

▼ B

Where auxiliaries were fitted in accordance with Appendix 2 of Annex VI there shall be no adjustment to the instantaneous engine torque in equation (7-59). Where, according to points 6.3.2 or 6.3.3 of Annex VI to this regulation necessary auxiliaries that should have been fitted for the test are not installed, or auxiliaries that should have been removed for the test are installed, the value of T_i used in equation (7-59) shall be adjusted by means of equation (7-60):

$$T_i = T_{i,meas} + T_{i,AUX} \quad (7-60)$$

Where:

$T_{i,meas}$ = measured value of instantaneous engine torque

▼ M2

$T_{i,AUX}$ = corresponding value of torque required to drive auxiliaries determined in accordance with equation (6-18) of Annex VI.

▼ B

The specific emissions e_{gas} [g/kWh] shall be calculated in the following ways depending on the type of test cycle.

$$e_{gas} = \frac{m_{gas}}{W_{act}} \quad (7-61)$$

Where:

m_{gas} = total mass of emission [g/test]

W_{act} = cycle work [kWh]

▼ B

In case of the NRTC, for gaseous emissions other than CO₂ the final test result e_{gas} [g/kWh] shall be a weighted average from cold-start run and hot-start run by means of equation (7-62):

$$e_{\text{gas}} = \frac{(0,1 \cdot m_{\text{cold}}) + (0,9 \cdot m_{\text{hot}})}{(0,1 \cdot W_{\text{act,cold}}) + (0,9 \cdot W_{\text{act,hot}})} \quad (7-62)$$

Where:

m_{cold} is the gas mass emissions of the cold-start NRTC [g]

$W_{\text{act,cold}}$ is the actual cycle work of the cold-start NRTC [kWh]

m_{hot} is the gas mass emissions of the hot-start NRTC [g]

$W_{\text{act,hot}}$ is the actual cycle work of the hot-start NRTC [kWh]

In case of the NRTC, for CO₂ the final test result e_{CO_2} [g/kWh] shall be calculated from the hot-start NRTC by means of equation (7-63):

$$e_{\text{CO}_2,\text{hot}} = \frac{m_{\text{CO}_2,\text{hot}}}{W_{\text{act,hot}}} \quad (7-63)$$

Where:

$m_{\text{CO}_2,\text{hot}}$ is the CO₂ mass emissions of the hot-start NRTC [g]

$W_{\text{act,hot}}$ is the actual cycle work of the hot-start NRTC [kWh]

2.4.1.2. Discrete-mode NRSC

The specific emissions e_{gas} [g/kWh] are calculated by means of equation (7-64):

$$e_{\text{gas}} = \frac{\sum_{i=1}^{N_{\text{mode}}} (q_{m_{\text{gas},i}} \cdot WF_i)}{\sum_{i=1}^{N_{\text{mode}}} (P_i \cdot WF_i)} \quad (7-64)$$

where:

$q_{m_{\text{gas},i}}$ = mean emission mass flow rate for the mode i [g/h]

▼ M2

P_i = engine power for the mode i [kW] calculated by adding to the measured power P_{meas} [kW] the power required to drive auxiliaries P_{AUX} [kW] determined in accordance with equation (6-8) of Annex VI ($P_i = P_{\text{meas}} + P_{\text{AUX}}$)

▼ B

WF_i = weighting factor for the mode i [-]

▼ M2

N_{mode} = number of modes in applicable discrete-mode NRSC

▼ B

2.4.2. Particulate emissions

2.4.2.1. Transient (NRTC and LSI-NRTC) test cycles and RMC

The particulate specific emissions shall be calculated with equation (7-61) where e_{gas} [g/kWh] and m_{gas} [g/test] are substituted by e_{PM} [g/kWh] and m_{PM} [g/test] respectively:

$$e_{\text{PM}} = \frac{m_{\text{PM}}}{W_{\text{act}}} \quad (7-65)$$

where:

m_{PM} = total mass of particulates emission, calculated in accordance with point 2.3.1.1 or 2.3.1.2 [g/test]

W_{act} = cycle work [kWh]

▼ B

The emissions on the transient composite cycle (i.e. cold-start NRTC and hot-start NRTC) shall be calculated as shown in point 2.4.1.1.

2.4.2.2. Discrete-mode NRSC

The particulate specific emission e_{PM} [g/kWh] shall be calculated by means of equations (7-66) or (7-67):

(a) For the single-filter method

▼ M2

$$e_{PM} = \frac{q_{mPM}}{\sum_{i=1}^{N_{mode}} (P_i \cdot WF_i)} \quad (7-66)$$

▼ B

where:

▼ M2

P_i = engine power for the mode i [kW] calculated by adding to the measured power P_{meas} [kW] the power required to drive auxiliaries P_{AUX} [kW] determined in accordance with equation (6-8) of Annex VI ($P_i = P_{meas} + P_{AUX}$)

▼ B

WF_i = weighting factor for the mode i [-]

q_{mPM} = particulate mass flow rate [g/h]

▼ M2

N_{mode} = number of modes in applicable discrete-mode NRSC

▼ B

(b) For the multiple-filter method

▼ M2

$$e_{PM} = \frac{\sum_{i=1}^{N_{mode}} (q_{mPMi} \cdot WF_i)}{\sum_{i=1}^{N_{mode}} (P_i \cdot WF_i)} \quad (7-67)$$

▼ B

Where:

▼ M2

P_i = engine power for the mode i [kW] calculated by adding to the measured power P_{meas} [kW] the power required to drive auxiliaries P_{AUX} [kW] determined in accordance with equation (6-8) of Annex VI ($P_i = P_{meas} + P_{AUX}$)

▼ B

WF_i = weighting factor for the mode i [-]

q_{mPMi} = particulate mass flow rate at mode i [g/h]

▼ M2

N_{mode} = number of modes in applicable discrete-mode NRSC

▼ B

For the single-filter method, the effective weighting factor, WF_{ei} , for each mode shall be calculated by means of equation (7-68):

$$WF_{ei} = \frac{m_{sep_i} \cdot \overline{q_{medf}}}{m_{sep} \cdot \overline{q_{medf_i}}} \quad (7-68)$$

Where:

m_{sep_i} = mass of the diluted exhaust gas sample passed through the particulate sampling filters at mode i [kg]

$\overline{q_{medf}}$ = average equivalent diluted exhaust gas mass flow rate [kg/s]

q_{medf_i} = equivalent diluted exhaust gas mass flow rate at mode i [kg/s]

m_{sep} = mass of the diluted exhaust gas sample passed through the particulate sampling filters [kg]

▼ B

The value of the effective weighting factors shall be within 0,005 (absolute value) of the weighting factors listed in Appendix 1 of Annex XVII.

2.4.3. Adjustment for emission controls that are regenerated on an infrequent (periodic) basis

In case of engines, other than those of category RLL, equipped with exhaust after-treatment systems that are regenerated on an infrequent (periodic) basis (see point 6.6.2 of Annex VI), the specific emissions of gaseous and particulate pollutants calculated according to points 2.4.1 and 2.4.2 shall be corrected with either the applicable multiplicative adjustment factor or with the applicable additive adjustment factor. In the case that infrequent regeneration did not take place during the test the upward factor shall be applied ($k_{ru,m}$ or $k_{ru,a}$). In the case that infrequent regeneration took place during the test the downward factor shall be applied ($k_{rd,m}$ or $k_{rd,a}$). In the case of the discrete-mode NRSC, where the adjustment factors have been determined for each mode they shall be applied to each mode during the calculation of the weighted emission result.

2.4.4. Adjustment for deterioration factor

The specific emissions of gaseous and particulate pollutants calculated according to points 2.4.1 and 2.4.2, where applicable inclusive of the infrequent regeneration adjustment factor according to point 2.4.3, shall also be adjusted by the applicable multiplicative or additive deterioration factor established according to the requirements of Annex III.

2.5. Diluted Exhaust Flow (CVS) Calibration and Related Calculations

The CVS system shall be calibrated by using an accurate flowmeter and a restricting device. The flow through the system shall be measured at different restriction settings, and the control parameters of the system shall be measured and related to the flow.

Various types of flowmeters may be used, e.g. calibrated venturi, calibrated laminar flowmeter, calibrated turbine meter.

2.5.1. Positive displacement pump (PDP)

All the parameters related to the pump shall be simultaneously measured along with the parameters related to a calibration venturi which is connected in series with the pump. The calculated flow rate (in m^3/s at pump inlet, absolute pressure and temperature) shall be plotted versus a correlation function which is the value of a specific combination of pump parameters. The linear equation which relates the pump flow and the correlation function shall be determined. If a CVS has a multiple speed drive, the calibration shall be performed for each range used.

Temperature stability shall be maintained during calibration.

Leaks in all the connections and ducting between the calibration venturi and the CVS pump shall be maintained lower than 0,3 % of the lowest flow point (highest restriction and lowest PDP speed point).

The airflow rate ($q_{V_{CVS}}$) at each restriction setting (minimum 6 settings) shall be calculated in standard m^3/s from the flowmeter data using the manufacturer's prescribed method. The airflow rate shall then be converted to pump flow (V_0) in m^3/rev at absolute pump inlet temperature and pressure by means of equation (7-69):

▼ B

$$V_0 = \frac{q_{VCVS}}{n} \cdot \frac{T}{273,15} \cdot \frac{101,325}{p_p} \quad (7-69)$$

where:

q_{VCVS} = airflow rate at standard conditions (101,325 kPa, 273,15 K)
[m³/s]

T = temperature at pump inlet [K]

p_p = absolute pressure at pump inlet [kPa]

n = pump speed [rev/s]

To account for the interaction of pressure variations at the pump and the pump slip rate, the correlation function (X_0) [s/rev] between pump speed, pressure differential from pump inlet to pump outlet and absolute pump outlet pressure shall be calculated by means of equation (7-70):

$$X_0 = \frac{1}{n} \cdot \sqrt{\frac{\Delta p_p}{p_p}} \quad (7-70)$$

Where:

Δp_p = pressure differential from pump inlet to pump outlet [kPa]

p_p = absolute outlet pressure at pump outlet [kPa]

n = pump speed [rev/s]

A linear least-square fit shall be performed to generate the calibration by means of equation (7-71):

$$V_0 = D_0 - m \cdot X_0 \quad (7-71)$$

with D_0 [m³/rev] and m [m³/s], intercept and slope respectively, describing the regression line.

For a CVS system with multiple speeds, the calibration curves generated for the different pump flow ranges shall be approximately parallel, and the intercept values (D_0) shall increase as the pump flow range decreases.

The calculated values from the equation shall be within $\pm 0,5$ % of the measured value of V_0 . Values of m will vary from one pump to another. Particulate influx over time will cause the pump slip to decrease, as reflected by lower values for m . Therefore, calibration shall be performed at pump start-up, after major maintenance, and if the total system verification indicates a change of the slip rate.

2.5.2. Critical flow venturi (CFV)

Calibration of the CFV is based upon the flow equation for a critical venturi. Gas flow is a function of venturi inlet pressure and temperature.

To determine the range of critical flow, K_V shall be plotted as a function of venturi inlet pressure. For critical (choked) flow, K_V will have a relatively constant value. As pressure decreases (vacuum increases), the venturi becomes unchoked and K_V decreases, which indicates that the CFV is operated outside the permissible range.

▼ B

The airflow rate ($q_{V_{CVS}}$) at each restriction setting (minimum 8 settings) shall be calculated in standard m^3/s from the flowmeter data using the manufacturer's prescribed method. The calibration coefficient K_V [$(\sqrt{\text{K}} \cdot \text{m}^4 \cdot \text{s})/\text{kg}$] shall be calculated from the calibration data for each setting by means of equation (7-72):

$$K_V = \frac{q_{V_{CVS}} \cdot \sqrt{T}}{p_p} \quad (7-72)$$

Where:

$q_{V_{SSV}}$ = air flow rate at standard conditions (101,325 kPa, 273,15 K) [m^3/s]

T = temperature at the venturi inlet [K]

p_p = absolute pressure at venturi inlet [kPa]

The average K_V and the standard deviation shall be calculated. The standard deviation shall not exceed $\pm 0,3\%$ of the average K_V .

2.5.3. Subsonic venturi (SSV)

Calibration of the SSV is based upon the flow equation for a subsonic venturi. Gas flow is a function of inlet pressure and temperature, pressure drop between the SSV inlet and throat, as shown in equation (7-40).

The airflow rate ($q_{V_{SSV}}$) at each restriction setting (minimum 16 settings) shall be calculated in standard m^3/s from the flowmeter data using the manufacturer's prescribed method. The discharge coefficient shall be calculated from the calibration data for each setting by means of equation (7-73):

$$C_d = \frac{q_{V_{SSV}}}{\frac{A_0}{60} d_V^2 \sqrt{p_p} \sqrt{\left[\frac{1}{T_{in,V}} (r_p^{1,4286} - r_p^{1,7143}) \left(\frac{1}{1 - r_D^4 r_p^{1,4286}} \right) \right]}} \quad (7-73)$$

Where:

A_0 = collection of constants and units conversions
 $= 0,0056940 \left[\frac{\text{m}^3}{\text{min}} \cdot \frac{\text{K}^{\frac{1}{2}}}{\text{kPa}} \cdot \frac{1}{\text{mm}^2} \right]$

$q_{V_{SSV}}$ = air flow rate at standard conditions (101,325 kPa, 273,15 K) [m^3/s]

$T_{in,V}$ = temperature at the venturi inlet [K]

d_V = diameter of the SSV throat [mm]

r_p = ratio of the SSV throat to inlet absolute static pressure = $1 - \Delta p/p_p$ [-]

r_D = ratio of the SSV throat diameter, d_V , to the inlet pipe inner diameter D [-]

To determine the range of subsonic flow, C_d shall be plotted as a function of Reynolds number Re , at the SSV throat. The Re at the SSV throat shall be calculated by means of equation (7-74):

$$Re = A_1 \cdot 60 \cdot \frac{q_{V_{SSV}}}{d_V \cdot \mu} \quad (7-74)$$

with

$$\mu = \frac{b \times T^{1,5}}{S + T} \quad (7-75)$$

▼ B

Where:

$$A_1 = \text{collection of constants and units conversions} = 27,43831 \left[\frac{\text{Kg}}{\text{m}^3} \cdot \frac{\text{min}}{\text{s}} \cdot \frac{\text{mm}}{\text{m}} \right]$$

$$q_{VSSV} = \text{air flow rate at standard conditions (101,325 kPa, 273,15 K)} \quad [\text{m}^3/\text{s}]$$

$$d_v = \text{diameter of the SSV throat [mm]}$$

$$\mu = \text{absolute or dynamic viscosity of the gas [kg/(m} \cdot \text{s)]}$$

$$b = 1,458 \times 10^6 \text{ (empirical constant) [kg/(m} \cdot \text{s} \cdot \text{K}^{0,5})]$$

$$S = 110,4 \text{ (empirical constant) [K]}$$

Because q_{VSSV} is an input to the Re equation, the calculations shall be started with an initial guess for q_{VSSV} or C_d of the calibration venturi, and repeated until q_{VSSV} converges. The convergence method shall be accurate to 0,1 % of point or better.

For a minimum of sixteen points in the region of subsonic flow, the calculated values of C_d from the resulting calibration curve fit equation shall be within $\pm 0,5$ % of the measured C_d for each calibration point.

2.6. Drift Correction

2.6.1. General procedure

The calculations in this section shall be performed to determine if gas analyzer drift invalidates the results of a test interval. If drift does not invalidate the results of a test interval, the test interval's gas analyzer responses shall be corrected for drift in accordance with point 2.6.2. The drift-corrected gas analyzer responses shall be used in all subsequent emission calculations. The acceptable threshold for gas analyzer drift over a test interval is specified in point 8.2.2.2 of Annex VI.

The general test procedure shall follow the provisions specified in Appendix 1 with concentrations x_i or \bar{x} being replaced by concentrations c_i or \bar{c} .

2.6.2. Calculation procedure

The drift correction shall be calculated by means of equation (7-76):

$$c_{\text{idriftcor}} = c_{\text{refzero}} + (c_{\text{refspan}} - c_{\text{refzero}}) \frac{2c_i - (c_{\text{prezero}} + c_{\text{postzero}})}{(c_{\text{prespan}} + c_{\text{postspan}}) - (c_{\text{prezero}} + c_{\text{postzero}})} \quad (7-76)$$

Where:

$$c_{\text{idriftcor}} = \text{concentration corrected for drift [ppm]}$$

$$c_{\text{refzero}} = \text{reference concentration of the zero gas, which is usually zero unless known to be otherwise [ppm]}$$

$$c_{\text{refspan}} = \text{reference concentration of the span gas [ppm]}$$

$$c_{\text{prespan}} = \text{pre-test interval gas analyzer response to the span gas concentration [ppm]}$$

$$c_{\text{postspan}} = \text{post-test interval gas analyzer response to the span gas concentration [ppm]}$$

▼B

c_i or \bar{c} = concentration recorded, i.e. measured, during test, before drift correction [ppm]

c_{prezero} = pre-test interval gas analyzer response to the zero gas concentration [ppm]

c_{postzero} = post-test interval gas analyzer response to the zero gas concentration [ppm]

3. Molar based emissions calculation

3.1. Subscripts

	Quantity
abs	Absolute quantity
act	Actual quantity
air	Air, dry
atmos	Atmospheric
bkgnd	Background
C	Carbon
cal	Calibration quantity
CFV	Critical flow venturi
cor	Corrected quantity
dil	Dilution air
dexh	Diluted exhaust gas
dry	Dry quantity
exh	Raw exhaust gas
exp	Expected quantity
eq	Equivalent quantity
fuel	Fuel
	Instantaneous measurement (e.g.: 1 Hz)
<i>i</i>	An individual of a series
idle	Condition at idle
in	Quantity in
init	Initial quantity, typically before an emission test
max	Maximum (i.e. peak) value
meas	Measured quantity
min	Minimum value
mix	Molar mass of air
out	Quantity out

▼B

	Quantity
part	Partial quantity
PDP	Positive displacement pump
raw	Raw exhaust
ref	Reference quantity
rev	Revolution
sat	Saturated condition
slip	PDP slip
smpl	Sampling
span	Span quantity
SSV	Subsonic venturi
std	Standard quantity
test	Test quantity
total	Total quantity
uncor	Uncorrected quantity
vac	Vacuum quantity
weight	Calibration weight
wet	Wet quantity
zero	Zero quantity

3.2. Symbols for chemical balance

$x_{\text{dil/exh}}$ = Amount of dilution gas or excess air per mole of exhaust gas

$x_{\text{H}_2\text{Oexh}}$ = Amount of water in exhaust per mole of exhaust gas

x_{Ccombdry} = Amount of carbon from fuel in the exhaust per mole of dry exhaust gas

$x_{\text{H}_2\text{Oexhdry}}$ = Amount of water in exhaust per dry mole of dry exhaust gas

$x_{\text{prod/intdry}}$ = Amount of dry stoichiometric products per dry mole of intake air

$x_{\text{dil/exhdry}}$ = Amount of dilution gas and/or excess air per mole of dry exhaust gas

$x_{\text{int/exhdry}}$ = Amount of intake air required to produce actual combustion products per mole of dry (raw or diluted) exhaust gas

$x_{\text{raw/exhdry}}$ = Amount of undiluted exhaust gas, without excess air, per mole of dry (raw or diluted) exhaust gas

$x_{\text{O}_2\text{intdry}}$ = Amount of intake air O_2 per mole of dry intake air

$x_{\text{CO}_2\text{intdry}}$ = Amount of intake air CO_2 per mole of dry intake air

▼ B

$x_{\text{H}_2\text{Ointdry}}$ = Amount of intake air H_2O per mole of dry intake air

$x_{\text{CO}_2\text{int}}$ = Amount of intake air CO_2 per mole of intake air

$x_{\text{CO}_2\text{dil}}$ = Amount of dilution gas CO_2 per mole of dilution gas

$x_{\text{CO}_2\text{dildry}}$ = Amount of dilution gas CO_2 per mole of dry dilution gas

$x_{\text{H}_2\text{Odildry}}$ = Amount of dilution gas H_2O per mole of dry dilution gas

$x_{\text{H}_2\text{Odil}}$ = Amount of dilution gas H_2O per mole of dilution gas

$x_{[\text{emission}]_{\text{meas}}}$ = Amount of measured emission in the sample at the respective gas analyzer

$x_{[\text{emission}]_{\text{dry}}}$ = Amount of emission per dry mole of dry sample

$x_{\text{H}_2\text{O}[\text{emission}]_{\text{meas}}}$ = Amount of water in sample at emission-detection location

$x_{\text{H}_2\text{Oint}}$ = Amount of water in the intake air, based on a humidity measurement of intake air

3.3. Basic parameters and relationships

3.3.1. Dry air and chemical species

This section uses the following values for dry air composition:

$x_{\text{O}_2\text{airdry}} = 0,209445 \text{ mol/mol}$

$x_{\text{Arairdry}} = 0,00934 \text{ mol/mol}$

$x_{\text{N}_2\text{airdry}} = 0,78084 \text{ mol/mol}$

$x_{\text{CO}_2\text{airdry}} = 375 \text{ } \mu\text{mol/mol}$

This section uses the following molar masses or effective molar masses of chemical species:

$M_{\text{air}} = 28,96559 \text{ g/mol}$ (dry air)

$M_{\text{Ar}} = 39,948 \text{ g/mol}$ (argon)

$M_{\text{C}} = 12,0107 \text{ g/mol}$ (carbon)

$M_{\text{CO}} = 28,0101 \text{ g/mol}$ (carbon monoxide)

$M_{\text{CO}_2} = 44,0095 \text{ g/mol}$ (carbon dioxide)

$M_{\text{H}} = 1,00794 \text{ g/mol}$ (atomic hydrogen)

$M_{\text{H}_2} = 2,01588 \text{ g/mol}$ (molecular hydrogen)

$M_{\text{H}_2\text{O}} = 18,01528 \text{ g/mol}$ (water)

$M_{\text{He}} = 4,002602 \text{ g/mol}$ (helium)

$M_{\text{N}} = 14,0067 \text{ g/mol}$ (atomic nitrogen)

$M_{\text{N}_2} = 28,0134 \text{ g/mol}$ (molecular nitrogen)

$M_{\text{NO}_x} = 46,0055 \text{ g/mol}$ (oxides of nitrogen (*))

$M_{\text{O}} = 15,9994 \text{ g/mol}$ (atomic oxygen)

$M_{\text{O}_2} = 31,9988 \text{ g/mol}$ (molecular oxygen)

▼ B

$M_{C_3H_8} = 44,09562 \text{ g/mol}$ (propane)

$M_S = 32,065 \text{ g/mol}$ (sulphur)

$M_{HC} = 13,875389 \text{ g/mol}$ (total hydrocarbon (**))

(**) The effective molar mass of HC is defined by an atomic hydrogen-to-carbon ratio, α , of 1,85;

(*) The effective molar mass of NO_x is defined by the molar mass of nitrogen dioxide, NO₂.

This section uses the following molar gas constant R for ideal gases:

$R = 8,314472 \text{ J (mol} \cdot \text{K)}$

This section uses the following ratios of specific heats γ [J/(kg · K)]/[J/(kg · K)] for dilution air and diluted exhaust:

$\gamma_{\text{air}} = 1,399$ (ratio of specific heats for intake air or dilution air)

$\gamma_{\text{dil}} = 1,399$ (ratio of specific heats for diluted exhaust gas)

$\gamma_{\text{exh}} = 1,385$ (ratio of specific heats for raw exhaust gas)

3.3.2. Wet air

This section describes how to determine the amount of water in an ideal gas:

3.3.2.1. Vapour pressure of water

The vapour pressure of water p_{H_2O} [kPa] for a given saturation temperature condition, T_{sat} [K], shall be calculated by means of equations (7-77) or (7-78):

(a) For humidity measurements made at ambient temperatures from 0 to 100 °C or for humidity measurements made over super-cooled water at ambient temperatures from – 50 to 0 °C:

$$\log_{10}(p_{H_2O}) = 10,79574 \cdot \left(1 - \frac{273,16}{T_{\text{sat}}}\right) - 5,02800 \cdot \log_{10}\left(\frac{T_{\text{sat}}}{273,16}\right) + 1,50475 \cdot 10^{-4} \cdot \left(1 - 10^{-8,2969 \cdot \left(\frac{T_{\text{sat}}}{273,16} - 1\right)}\right) + 0,42873 \cdot 10^{-3} \cdot \left(10^{4,76955 \cdot \left(1 - \frac{273,16}{T_{\text{sat}}}\right)} - 1\right) - 0,2138602 \quad (7-77)$$

Where:

p_{H_2O} = vapour pressure of water at saturation temperature condition [kPa]

T_{sat} = saturation temperature of water at measured condition [K]

(b) For humidity measurements made over ice at ambient temperatures from (– 100 to 0) °C:

$$\log_{10}(p_{H_2O}) = -9,096853 \cdot \left(\frac{273,16}{T_{\text{sat}}} - 1\right) - 3,566506 \cdot \log_{10}\left(\frac{273,16}{T_{\text{sat}}}\right) + 0,876812 \cdot \left(1 - \frac{T_{\text{sat}}}{273,16}\right) - 0,2138602 \quad (7-78)$$

Where:

T_{sat} = saturation temperature of water at measured condition [K]

▼ B

3.3.2.2. Dew point

If humidity is measured as a dew point, the amount of water in an ideal gas $x_{\text{H}_2\text{O}}$ [mol/mol] shall be obtained by means of equation (7-79):

$$x_{\text{H}_2\text{O}} = \frac{p_{\text{H}_2\text{O}}}{p_{\text{abs}}} \quad (7-79)$$

Where:

$x_{\text{H}_2\text{O}}$ = amount of water in an ideal gas [mol/mol]

$p_{\text{H}_2\text{O}}$ = vapour pressure of water at the measured dew point, $T_{\text{sat}}=T_{\text{dew}}$ [kPa]

p_{abs} = wet static absolute pressure at the location of dew point measurement [kPa]

3.3.2.3. Relative humidity

If humidity is measured as a relative humidity $RH\%$, the amount of water of an ideal gas $x_{\text{H}_2\text{O}}$ [mol/mol] is calculated by means of equation (7-80):

$$x_{\text{H}_2\text{O}} = \frac{RH\%}{100} \cdot \frac{RH\%}{100} \cdot \frac{p_{\text{H}_2\text{O}}}{p_{\text{abs}}} \quad (7-80)$$

Where:

$RH\%$ = relative humidity [%]

$p_{\text{H}_2\text{O}}$ = water vapour pressure at 100 % relative humidity at the location of relative humidity measurement, $T_{\text{sat}}=T_{\text{amb}}$ [kPa]

p_{abs} = wet static absolute pressure at the location of relative humidity measurement [kPa]

3.3.2.4. Dew point determination from relative humidity and dry bulb temperature

If humidity is measured as a relative humidity, $RH\%$, the dew point, T_{dew} , shall be determined from $RH\%$ and dry bulb temperature by means of equation (7-81):

$$T_{\text{dew}} = \frac{2,0798233 \cdot 10^2 - 2,0156028 \cdot 10^1 \cdot \ln(p_{\text{H}_2\text{O}}) + 4,6778925 \cdot 10^{-1} \cdot \ln(p_{\text{H}_2\text{O}})^2 - 9,2288067 \cdot 10^{-6} \cdot \ln(p_{\text{H}_2\text{O}})^3}{1 - 1,3319669 \cdot 10^{-1} \cdot \ln(p_{\text{H}_2\text{O}}) + 5,6577518 \cdot 10^{-3} \cdot \ln(p_{\text{H}_2\text{O}})^2 - 7,517286510 \cdot 10^{-5} \ln(p_{\text{H}_2\text{O}})^3} \quad (7-81)$$

Where

$p_{\text{H}_2\text{O}}$ = water vapor pressure scaled to the relative humidity at the location of relative humidity measurement, $T_{\text{sat}} = T_{\text{amb}}$

T_{dew} = dew point as determined from relative humidity and dry bulb temperature measurements

3.3.3. Fuel properties

The general chemical formula of fuel is $\text{CH}_\alpha\text{O}_\beta\text{S}_\gamma\text{N}_\delta$ with α atomic hydrogen-to-carbon ratio (H/C), β atomic oxygen-to-carbon ratio (O/C), γ atomic sulphur-to-carbon ratio (S/C) and δ atomic nitrogen-to-carbon ratio (N/C). Based on this formula the carbon mass fraction of fuel w_C can be calculated. In case of diesel fuel the simple formula $\text{CH}_\alpha\text{O}_\beta$ may be used. Default values for fuel composition may be derived from Table 7.3:

▼B

Table 7.3

Default values of atomic hydrogen-to-carbon ratio, α , atomic oxygen-to-carbon ratio, β , atomic sulphur-to-carbon ratio, γ , atomic nitrogen-to-carbon ratio, δ , and carbon mass fraction of fuel, w_C for reference fuels

Fuel	Atomic hydrogen, oxygen, sulphur and nitrogen-to-carbon ratios $CH_\alpha O_\beta S_\gamma N_\delta$	Carbon mass concentration, w_C [g/g]
Diesel (non-road gas-oil)	$CH_{1,80}O_0S_0N_0$	0,869
Ethanol for dedicated compression ignition engines (ED95)	$CH_{2,92}O_{0,46}S_0N_0$	0,538
Petrol (E10)	$CH_{1,92}O_{0,03}S_0N_0$	0,833
Petrol (E0)	$CH_{1,85}O_0S_0N_0$	0,866
Ethanol (E85)	$CH_{2,73}O_{0,36}S_0N_0$	0,576
LPG	$CH_{2,64}O_0S_0N_0$	0,819
Natural Gas/Biomethane	$CH_{3,78}O_{0,016}S_0N_0$	0,747

3.3.3.1. Calculation of carbon mass concentration w_C

As an alternative to the default values in Table 7.3, or where default values are not given for the reference fuel being used, the carbon mass concentration w_C may be calculated from measured fuel properties by means of equation (7-82). Values for α and β shall be determined for the fuel and inserted into the equation in all cases, but γ and δ may optionally be set to zero if they are zero in the corresponding line of Table 7.3:

$$w_C = \frac{1 \cdot M_C}{M_C + \alpha \cdot M_H + \beta M_O + \gamma \cdot M_S + \delta M_N} \quad (7-82)$$

where:

M_C = molar mass of carbon.

α = atomic hydrogen-to-carbon ratio of the mixture of fuel(s) being combusted, weighted by molar consumption.

M_H = molar mass of hydrogen.

β = atomic oxygen-to-carbon ratio of the mixture of fuel(s) being combusted, weighted by molar consumption.

M_O = molar mass of oxygen.

γ = atomic sulphur-to-carbon ratio of the mixture of fuel(s) being combusted, weighted by molar consumption.

M_S = molar mass of sulphur.

δ = atomic nitrogen-to-carbon ratio of the mixture of fuel(s) being combusted, weighted by molar consumption.

M_N = molar mass of nitrogen.

▼ B

3.3.4. Total HC (THC) concentration initial contamination correction

▼ M2

For HC measurement, $x_{\text{THC}[\text{THC-FID}]}$ shall be calculated by using the initial THC contamination concentration $x_{\text{THC}[\text{THC-FID}]_{\text{init}}}$ from point 7.3.1.3 of Annex VI by means of equation (7-83):

▼ B

$$x_{\text{THC}[\text{THC-FID}]_{\text{cor}}} = x_{\text{THC}[\text{THC-FID}]_{\text{uncorr}}} - x_{\text{THC}[\text{THC-FID}]_{\text{init}}} \quad (7-83)$$

Where:

$x_{\text{THC}[\text{THC-FID}]_{\text{cor}}}$ = THC concentration corrected for contamination [mol/mol]

$x_{\text{THC}[\text{THC-FID}]_{\text{uncorr}}}$ = THC uncorrected concentration [mol/mol]

$x_{\text{THC}[\text{THC-FID}]_{\text{init}}}$ = initial THC contamination concentration [mol/mol]

3.3.5. Flow-weighted mean concentration

In some points of this section, it may be necessary to calculate a flow-weighted mean concentration to determine the applicability of certain provisions. A flow-weighted mean is the mean of a quantity after it is weighted proportional to a corresponding flow rate. For example, if a gas concentration is measured continuously from the raw exhaust gas of an engine, its flow-weighted mean concentration is the sum of the products of each recorded concentration times its respective exhaust gas molar flow rate, divided by the sum of the recorded flow rate values. As another example, the bag concentration from a CVS system is the same as the flow-weighted mean concentration because the CVS system itself flow-weights the bag concentration.

► **M2** A certain flow-weighted mean concentration of an emission at the emission limit value might be already expected based on previous testing with similar engines or testing with similar equipment and instruments. ◀

3.4. Chemical balances of fuel, intake air, and exhaust gas

3.4.1. General

Chemical balances of fuel, intake air and exhaust gas may be used to calculate flows, the amount of water in their flows, and the wet concentration of constituents in their flows. With one flow rate of either fuel, intake air or exhaust gas, chemical balances may be used to determine the flows of the other two. For example, chemical balances along with either intake air or fuel flow to determine raw exhaust gas flow may be used.

3.4.2. Procedures that require chemical balances

Chemical balances are required to determine the following:

- (a) The amount of water in a raw or diluted exhaust gas flow, $x_{\text{H}_2\text{O}_{\text{exh}}}$, when the amount of water to correct for the amount of water removed by a sampling system is not measured;
- (b) The flow-weighted mean fraction of dilution air in diluted exhaust gas, $x_{\text{dil/exh}}$, when dilution air flow is not measured to correct for background emissions. It has to be noted that if chemical balances are used for this purpose, the exhaust gas is assumed to be stoichiometric, even if it is not.

▼B

3.4.3. Chemical balance procedure

The calculations for a chemical balance involve a system of equations that require iteration. The initial values of up to three quantities shall be guessed: the amount of water in the measured flow, $x_{\text{H}_2\text{O}_{\text{exh}}}$, fraction of dilution air in diluted exhaust gas (or excess air in the raw exhaust gas), $x_{\text{dil/exh}}$, and the amount of products on a C1 basis per dry mole of dry measured flow, $x_{\text{C}_{\text{combdry}}}$. Time-weighted mean values of combustion air humidity and dilution air humidity in the chemical balance may be used; as long as combustion air and dilution air humidity remain within tolerances of $\pm 0,0025$ mol/mol of their respective mean values over the test interval. For each emission concentration, x , and amount of water $x_{\text{H}_2\text{O}_{\text{exh}}}$, their completely dry concentrations, x_{dry} and $x_{\text{H}_2\text{O}_{\text{exhdry}}}$ shall be determined. The fuel atomic hydrogen-to-carbon ratio, α , oxygen-to-carbon ratio, β and carbon mass fraction of fuel, w_{C} shall also be used. For the test fuel, α and β or the default values in Table 7.3 may be used.

Use the following steps to complete a chemical balance:

- (a) Measured concentrations such as, $x_{\text{CO}_2\text{meas}}$, $x_{\text{NO}_{\text{meas}}}$, and $x_{\text{H}_2\text{O}_{\text{int}}}$, shall be converted to dry concentrations by dividing them by one minus the amount of water present during their respective measurements; for example: $x_{\text{H}_2\text{O}_x\text{CO}_2\text{meas}}$, $x_{\text{H}_2\text{O}_x\text{NO}_{\text{meas}}}$, and $x_{\text{H}_2\text{O}_{\text{int}}}$. If the amount of water present during a 'wet' measurement is the same as the unknown amount of water in the exhaust gas flow, $x_{\text{H}_2\text{O}_{\text{exh}}}$, it has to be iteratively solved for that value in the system of equations. If only total NO_x are measured and not NO and NO_2 separately, good engineering judgement shall be used to estimate a split in the total NO_x concentration between NO and NO_2 for the chemical balances. The molar concentration of NO_x , x_{NO_x} , may be assumed to be 75 % NO and 25 % NO_2 . For NO_2 storage after-treatment systems, x_{NO_x} may be assumed to be 25 % NO and 75 % NO_2 . For calculating the mass of NO_x emissions, the molar mass of NO_2 for the effective molar mass of all NO_x species, regardless of the actual NO_2 fraction of NO_x , shall be used;
- (b) Equations (7-82) to (7-99) in paragraph (d) of this point have to be entered into a computer program to iteratively solve for $x_{\text{H}_2\text{O}_{\text{exh}}}$, $x_{\text{C}_{\text{combdry}}}$ and $x_{\text{dil/exh}}$. Good engineering judgment shall be used to guess initial values for $x_{\text{H}_2\text{O}_{\text{exh}}}$, $x_{\text{C}_{\text{combdry}}}$, and $x_{\text{dil/exh}}$. Guessing an initial amount of water that is about twice the amount of water in the intake or dilution air is recommended. Guessing an initial value of $x_{\text{C}_{\text{combdry}}}$ as the sum of the measured CO_2 , CO , and THC values is recommended. Guessing an initial x_{dil} between 0,75 and 0,95, such as 0,8 is also recommended. Values in the system of equations shall be iterated until the most recently updated guesses are all within $\pm 1\%$ of their respective most recently calculated values;
- (c) The following symbols and subscripts are used in the equation system of paragraph (d) of this point where x unit is mol/mol:

Symbol	Description
$x_{\text{dil/exh}}$	Amount of dilution gas or excess air per mole of exhaust gas
$x_{\text{H}_2\text{O}_{\text{exh}}}$	Amount of H_2O in exhaust per mole of exhaust gas

▼B

Symbol	Description
x_{Ccombdry}	Amount of carbon from fuel in the exhaust per mole of dry exhaust gas
$x_{\text{H}_2\text{Oexhdry}}$	Amount of water in exhaust per dry mole of dry exhaust gas
$x_{\text{prod/intdry}}$	Amount of dry stoichiometric products per dry mole of intake air
$x_{\text{dil/exhdry}}$	Amount of dilution gas and/or excess air per mole of dry exhaust gas
$x_{\text{int/exhdry}}$	Amount of intake air required to produce actual combustion products per mole of dry (raw or diluted) exhaust gas
$x_{\text{raw/exhdry}}$	Amount of undiluted exhaust, without excess air, per mole of dry (raw or diluted) exhaust gas
$x_{\text{O}_2\text{intdry}}$	Amount of intake air O_2 per mole of dry intake air; $x_{\text{O}_2\text{intdry}} = 0,209445$ mol/mol may be assumed
$x_{\text{CO}_2\text{intdry}}$	Amount of intake air CO_2 per mole of dry intake air. $x_{\text{CO}_2\text{intdry}} = 375$ $\mu\text{mol/mol}$ may be used, but measuring the actual concentration in the intake air is recommended
$x_{\text{H}_2\text{Ointdry}}$	Amount of the intake air H_2O per mole of dry intake air
$x_{\text{CO}_2\text{int}}$	Amount of intake air CO_2 per mole of intake air
$x_{\text{CO}_2\text{dil}}$	Amount of dilution gas CO_2 per mole of dilution gas
$x_{\text{CO}_2\text{dildry}}$	Amount of dilution gas CO_2 per mole of dry dilution gas. If air is used as diluent, $x_{\text{CO}_2\text{dildry}} = 375$ $\mu\text{mol/mol}$ may be used, but measuring the actual concentration in the intake air is recommended
$x_{\text{H}_2\text{Odildry}}$	Amount of dilution gas H_2O per mole of dry dilution gas
$x_{\text{H}_2\text{Odil}}$	Amount of dilution gas H_2O per mole of dilution gas
$x_{[\text{emission}]\text{meas}}$	Amount of measured emission in the sample at the respective gas analyzer
$x_{[\text{emission}]\text{dry}}$	Amount of emission per dry mole of dry sample
$x_{\text{H}_2\text{O}[\text{emission}]\text{meas}}$	Amount of water in sample at emission-detection location. These values shall be measured or estimated according to point 9.3.2.3.1.

▼ B

Symbol	Description
$x_{\text{H}_2\text{Oint}}$	Amount of water in the intake air, based on a humidity measurement of intake air
$K_{\text{H}_2\text{Ogas}}$	Water-gas reaction equilibrium coefficient. 3,5 or a different value might be calculated using good engineering judgement.
α	Atomic hydrogen-to-carbon ratio of the mixture of fuel(s) ($\text{CH}_\alpha\text{O}_\beta$) being combusted, weighted by molar consumption
β	Atomic oxygen-to-carbon ratio of the mixture of fuel(s) ($\text{CH}_\alpha\text{O}_\beta$) being combusted, weighted by molar consumption

(d) The following equations [(7-84) to (7-101)] shall be used to iteratively solve for $x_{\text{dil/exh}}$, $x_{\text{H}_2\text{Oexh}}$ and x_{Ccombdry} :

$$x_{\text{dil/exh}} = 1 - \frac{x_{\text{raw/exhdry}}}{1 + x_{\text{H}_2\text{Oexhdry}}} \quad (7-84)$$

$$x_{\text{H}_2\text{Oexh}} = \frac{x_{\text{H}_2\text{Oexhdry}}}{1 + x_{\text{H}_2\text{Oexhdry}}} \quad (7-85)$$

$$x_{\text{Ccombdry}} = x_{\text{CO}_2\text{dry}} + x_{\text{COdry}} + x_{\text{THCdry}} - x_{\text{CO}_2\text{dil}} \cdot x_{\text{dil/exhdry}} - x_{\text{CO}_2\text{int}} \cdot x_{\text{int/exhdry}} \quad (7-86)$$

$$x_{\text{H}_2\text{dry}} = \frac{x_{\text{COdry}} \cdot (x_{\text{H}_2\text{Oexhdry}} - x_{\text{H}_2\text{Odil}} \cdot x_{\text{dil/exhdry}})}{K_{\text{H}_2\text{Ogas}} \cdot (x_{\text{CO}_2\text{dry}} - x_{\text{CO}_2\text{dil}} \cdot x_{\text{dil/exhdry}})} \quad (7-87)$$

$$x_{\text{H}_2\text{Oexhdry}} = \frac{\alpha}{2} (x_{\text{Ccombdry}} - x_{\text{THCdry}}) + x_{\text{H}_2\text{Odil}} \cdot x_{\text{dil/exhdry}} + x_{\text{H}_2\text{Oint}} \cdot x_{\text{int/exhdry}} - x_{\text{H}_2\text{dry}} \quad (7-88)$$

$$x_{\text{dil/exhdry}} = \frac{x_{\text{dil/exh}}}{1 - x_{\text{H}_2\text{Oexh}}} \quad (7-89)$$

$$x_{\text{int/exhdry}} = \frac{1}{2 \cdot x_{\text{O}_2\text{int}}} \left[\left(\frac{\alpha}{2} - \beta + 2 + 2\gamma \right) (x_{\text{Ccombdry}} - x_{\text{THCdry}}) - (x_{\text{COdry}} - x_{\text{NOdry}} - 2x_{\text{NO}_2\text{dry}} + x_{\text{H}_2\text{dry}}) \right] \quad (7-90)$$

$$x_{\text{raw/exhdry}} = \frac{1}{2} \left[\left(\frac{\alpha}{2} + \beta + \delta \right) (x_{\text{Ccombdry}} - x_{\text{THCdry}}) + (2x_{\text{THCdry}} + x_{\text{COdry}} - x_{\text{NO}_2\text{dry}} + x_{\text{H}_2\text{dry}}) \right] + x_{\text{int/exhdry}} \quad (7-91)$$

$$x_{\text{O}_2\text{int}} = \frac{0,209820 - x_{\text{CO}_2\text{intdry}}}{1 + x_{\text{H}_2\text{Ointdry}}} \quad (7-92)$$

$$x_{\text{CO}_2\text{int}} = \frac{x_{\text{CO}_2\text{intdry}}}{1 + x_{\text{H}_2\text{Ointdry}}} \quad (7-93)$$

$$x_{\text{H}_2\text{Ointdry}} = \frac{x_{\text{H}_2\text{Oint}}}{1 - x_{\text{H}_2\text{Oint}}} \quad (7-94)$$

$$x_{\text{CO}_2\text{dil}} = \frac{x_{\text{CO}_2\text{dildry}}}{1 + x_{\text{H}_2\text{Odildry}}} \quad (7-95)$$

$$x_{\text{H}_2\text{Odildry}} = \frac{x_{\text{H}_2\text{Odil}}}{1 - x_{\text{H}_2\text{Odil}}} \quad (7-96)$$

$$x_{\text{COdry}} = \frac{x_{\text{COmeas}}}{1 - x_{\text{H}_2\text{OCOmeas}}} \quad (7-97)$$

▼ B

$$x_{\text{CO2dry}} = \frac{x_{\text{CO2meas}}}{1 - x_{\text{H2OCO2meas}}} \quad (7-98)$$

$$x_{\text{NOdry}} = \frac{x_{\text{NOmeas}}}{1 - x_{\text{H2ONomeas}}} \quad (7-99)$$

$$x_{\text{NO2dry}} = \frac{x_{\text{NO2meas}}}{1 - x_{\text{H2ONO2meas}}} \quad (7-100)$$

$$x_{\text{THCdry}} = \frac{x_{\text{THCmeas}}}{1 - x_{\text{H2OTHCmeas}}} \quad (7-101)$$

At the end of the chemical balance, the molar flow rate is calculated as specified in points 3.5.3 and 3.6.3.

3.4.4. NO_x correction for humidity

All the NO_x concentrations, including dilution air background concentrations, shall be corrected for intake-air humidity using equation (7-102) or (7-103):

(a) For compression-ignition engines

$$x_{\text{NOxcor}} = x_{\text{NOxuncor}} \cdot (9,953 \cdot x_{\text{H2O}} + 0,832) \quad (7-102)$$

(b) For spark-ignition engines

$$x_{\text{NOxcor}} = x_{\text{NOxuncor}} \cdot (18,840 \cdot x_{\text{H2O}} + 0,68094) \quad (7-103)$$

Where:

x_{NOxuncor} = uncorrected NO_x molar concentration in the exhaust gas [$\mu\text{mol/mol}$]

x_{H2O} = amount of water in the intake air [mol/mol]

▼ M2

3.5. Measurement of gaseous emissions in raw exhaust gas

▼ B

3.5.1. Mass of gaseous emissions

To calculate the total mass per test of gaseous emission m_{gas} [g/test], its molar concentration shall be multiplied by its respective molar flow and by exhaust gas molar mass; then integration over test cycle shall be performed [equation (7-104)]:

$$m_{\text{gas}} = M_{\text{gas}} \cdot \int \dot{n}_{\text{exh}} \cdot x_{\text{gas}} \cdot dt \quad (7-104)$$

Where:

M_{gas} = molar mass of the generic gaseous emission [g/mol]

\dot{n}_{exh} = instantaneous exhaust gas molar flow rate on a wet basis [mol/s]

x_{gas} = instantaneous generic gas molar concentration on a wet basis [mol/mol]

t = time [s]

Since equation (7-104) has to be solved by numerical integration, it is transformed in equation (7-105):

$$m_{\text{gas}} = M_{\text{gas}} \cdot \int \dot{n}_{\text{exh}} \cdot x_{\text{gas}} \cdot dt \Rightarrow \quad (7-105)$$

$$m_{\text{gas}} = \frac{1}{f} \cdot M_{\text{gas}} \cdot \sum_{i=1}^N \dot{n}_{\text{exhi}} \cdot x_{\text{gasi}}$$

▼ B

Where:

M_{gas} = generic emission molar mass [g/mol]

\dot{n}_{exhi} = instantaneous exhaust gas molar flow rate on a wet basis [mol/s]

x_{gasi} = instantaneous generic gas molar concentration on a wet basis [mol/mol]

f = data sampling rate [Hz]

N = number of measurements [-]

General equation may be modified according to which measurement system is used, batch or continuous sampling, and if a varying rather than a constant flow rate is sampled.

- (a) For continuous sampling, in the general case of varying flow rate, the mass of the gaseous emission m_{gas} [g/test] shall be calculated by means of equation (7-106):

$$m_{\text{gas}} = \frac{1}{f} \cdot M_{\text{gas}} \cdot \sum_{i=1}^N \dot{n}_{\text{exhi}} \cdot x_{\text{gasi}} \quad (7-106)$$

Where:

M_{gas} = generic emission molar mass [g/mol]

\dot{n}_{exhi} = instantaneous exhaust gas molar flow rate on a wet basis [mol/s]

x_{gasi} = instantaneous gaseous emission molar fraction on a wet basis [mol/mol]

f = data sampling rate [Hz]

N = number of measurements [-]

- (b) Still for continuous sampling but in the particular case of constant flow rate the mass of the gaseous emission m_{gas} [g/test] shall be calculated by means of equation (7-107):

$$m_{\text{gas}} = M_{\text{gas}} \cdot \dot{n}_{\text{exh}} \cdot \bar{x}_{\text{gas}} \cdot \Delta t \quad (7-107)$$

Where:

M_{gas} = generic emission molar mass [g/mol]

\dot{n}_{exh} = exhaust gas molar flow rate on a wet basis [mol/s]

\bar{x}_{gas} = mean gaseous emission molar fraction on a wet basis [mol/mol]

Δt = time duration of test interval

- (c) For the batch sampling, regardless the flow rate is varying or constant, equation (7-104) can be simplified by means of equation (7-108):

$$m_{\text{gas}} = \frac{1}{f} \cdot M_{\text{gas}} \cdot \bar{x}_{\text{gas}} \cdot \sum_{i=1}^N \dot{n}_{\text{exhi}} \quad (7-108)$$

Where:

M_{gas} = generic emission molar mass [g/mol]

\dot{n}_{exhi} = instantaneous exhaust gas molar flow rate on a wet basis [mol/s]

\bar{x}_{gas} = mean gaseous emission molar fraction on a wet basis [mol/mol]

f = data sampling rate [Hz]

N = number of measurements [-]

▼ B

3.5.2. Dry-to-wet concentration conversion

Parameters of this point are obtained from the results of the chemical balance calculated in point 3.4.3. The following relation exists between gas molar concentrations in the measured flow x_{gasdry} and x_{gas} [mol/mol] expressed on a dry and wet basis respectively [equations (7-109) and (7-110)]:

$$x_{\text{gasdry}} = \frac{x_{\text{gas}}}{1 - x_{\text{H}_2\text{O}}} \quad (7-109)$$

$$x_{\text{gas}} = \frac{x_{\text{gasdry}}}{1 + x_{\text{H}_2\text{Odry}}} \quad (7-110)$$

where:

$x_{\text{H}_2\text{O}}$ = molar fraction of water in the measured flow on a wet basis [mol/mol]

$x_{\text{H}_2\text{Odry}}$ = molar fraction of water in the measured flow on a dry basis [mol/mol]

For gaseous emissions a removed water correction shall be performed for the generic concentration x [mol/mol] by means of equation (7-111):

$$x = x_{\text{[emission]meas}} \left[\frac{(1 - x_{\text{H}_2\text{Oexh}})}{1 - x_{\text{H}_2\text{O[emission]meas}}} \right] \quad (7-111)$$

Where:

$x_{\text{[emission]meas}}$ = molar fraction of emission in the measured flow at measurement location [mol/mol]

$x_{\text{H}_2\text{O[emission]meas}}$ = amount of water in the measured flow at the concentration measurement [mol/mol]

$x_{\text{H}_2\text{Oexh}}$ = amount of water at the flowmeter [mol/mol]

3.5.3. Exhaust gas molar flow rate

The flow rate of the raw exhaust gas can be directly measured or can be calculated based on the chemical balance of point 3.4.3. Calculation of raw exhaust gas molar flow rate is performed from measured intake air molar flow rate or fuel mass flow rate. The raw exhaust gas molar flow rate can be calculated from the sampled emissions, \dot{n}_{exh} , based on the measured intake air molar flow rate, \dot{n}_{int} , or the measured fuel mass flow rate, \dot{m}_{fuel} , and the values calculated using the chemical balance in point 3.4.3. It shall be solved for the chemical balance in point 3.4.3 at the same frequency that \dot{n}_{int} or \dot{m}_{fuel} is updated and recorded.

(a) Crankcase flow rate. The raw exhaust gas flow can be calculated based on \dot{n}_{int} or \dot{m}_{fuel} only if at least one of the following is true about crankcase emission flow rate:

(i) The test engine has a production emission-control system with a closed crankcase that routes crankcase flow back to the intake air, downstream of intake air flow meter;

(ii) During emission testing open crankcase flow shall be routed to the exhaust gas according to point 6.10 of Annex VI;

▼ B

(iii) Open crankcase emissions and flow are measured and added brake-specific emission calculations;

(iv) Using emission data or an engineering analysis, it can be demonstrated that neglecting the flow rate of open crankcase emissions does not adversely affect compliance with the applicable standards;

(b) Molar flow rate calculation based on intake air.

Based on \dot{n}_{int} , exhaust gas molar flow rate \dot{n}_{exh} [mol/s] shall be calculated by means of equation (7-112):

$$\dot{n}_{exh} = \frac{\dot{n}_{int}}{1 + \frac{(x_{int/exhdry} - x_{raw/exhdry})}{(1 + x_{H_2Oexhdry})}} \quad (7-112)$$

Where:

\dot{n}_{exh} = raw exhaust gas molar flow rate from which emissions are measured [mol/s]

\dot{n}_{ind} = intake air molar flow rate including humidity in intake air [mol/s]

$x_{int/exhdry}$ = amount of intake air required to produce actual combustion products per mole of dry (raw or diluted) exhaust gas [mol/mol]

$x_{raw/exhdry}$ = amount of undiluted exhaust gas, without excess air, per mole of dry (raw or diluted) exhaust gas [mol/mol]

$x_{H_2Oexhdry}$ = amount of water in exhaust gas per mole of dry exhaust gas [mol/mol]

(c) Molar flow rate calculation based on fuel mass flow rate

Based on \dot{m}_{fuel} , \dot{n}_{exh} [mol/s] shall be calculated as follows:

When conducting laboratory testing this calculation may only be used for discrete-mode NRSC and RMC [equation (7-113)]:

▼ M2

$$\dot{n}_{exh} = \frac{\dot{m}_{fuel} \cdot W_C \cdot (1 + x_{H_2Oexhdry})}{M_C \cdot X_{Ccombdry}} \quad (7-113)$$

▼ B

Where:

\dot{n}_{exh} = raw exhaust gas molar flow rate from which emissions are measured

\dot{m}_{fuel} = fuel flow rate including humidity in intake air [g/s]

w_C = carbon mass fraction for the given fuel [g/g]

$x_{H_2Oexhdry}$ = amount of H₂O per dry mole of measured flow [mol/mol]

M_C = molecular mass of carbon 12,0107 g/mol

$x_{Ccombdry}$ = amount of carbon from fuel in the exhaust gas per mole of dry exhaust gas [mol/mol]

▼ B

- (d) Exhaust gas molar flow rate calculation based on measured intake air molar flow rate, diluted exhaust gas molar flow rate, and dilute chemical balance

Exhaust gas molar flow rate \dot{n}_{exh} [mol/s] may be calculated based on the measured intake air molar flow rate, \dot{n}_{int} , the measured diluted exhaust gas molar flow rate, \dot{n}_{dexh} , and the values calculated using the chemical balance in point 3.4.3. Note that the chemical balance must be based on diluted exhaust gas concentrations. For continuous-flow calculations, solve for the chemical balance in point 3.4.3 at the same frequency that \dot{n}_{int} and \dot{n}_{dexh} are updated and recorded. This calculated \dot{n}_{dexh} may be used for the PM dilution ratio verification, the calculation of dilution air molar flow rate in the background correction in point 3.6.1 and the calculation of mass of emissions in point 3.5.1 for species that are measured in the raw exhaust gas.

Based on diluted exhaust gas and intake air molar flow rate, exhaust gas molar flow rate, \dot{n}_{exh} [mol/s] shall be calculated as follows:

$$\dot{n}_{\text{exh}} = (x_{\text{raw/exhdry}} - x_{\text{int/exhdry}}) \cdot (1 - x_{\text{H}_2\text{Oexh}}) \cdot \dot{n}_{\text{dexh}} + \dot{n}_{\text{int}} \quad (7-114)$$

where

\dot{n}_{exh} = raw exhaust gas molar flow rate from which emissions are measured [mol/s];

$x_{\text{int/exhdry}}$ = amount of intake air required to produce actual combustion products per mole of dry (raw or diluted) exhaust gas [mol/mol];

$x_{\text{raw/exhdry}}$ = amount of undiluted exhaust gas, without excess air, per mole of dry (raw or diluted) exhaust gas [mol/mol];

$x_{\text{H}_2\text{Oexh}}$ = amount of water in exhaust gas per mole of exhaust gas [mol/mol];

\dot{n}_{dexh} = diluted exhaust gas molar flow rate from which emissions are measured [mol/s];

\dot{n}_{int} = intake air molar flow rate including humidity in intake air [mol/s].

3.6. Diluted gaseous emissions

▼ M2

3.6.1. Emission mass calculation and background correction

The calculation of gaseous emissions mass m_{gas} [g/test] as a function of molar emissions flow rates shall be calculated as follows:

- (a) Continuous sampling, varying flow rate, shall be calculated by means of equation (7-106):

$$m_{\text{gas}} = \frac{1}{f} \cdot M_{\text{gas}} \cdot \sum_{i=1}^N \dot{n}_{\text{exhi}} \cdot X_{\text{gasi}} \quad [\text{see equation (7-106)}]$$

Where:

M_{gas} = generic emission molar mass [g/mol]

\dot{n}_{exhi} = instantaneous exhaust gas molar flow rate on a wet basis [mol/s]

x_{gasi} = instantaneous generic gas molar concentration on a wet basis [mol/mol]

f = data sampling rate [Hz]

N = number of measurements [-]

▼ **M2**

- (b) Continuous sampling, constant flow rate, shall be calculated by means of equation (7-107):

$$m_{gas} = M_{gas} \cdot \dot{n}_{exh} \cdot \bar{x}_{gas} \cdot \Delta t \quad [\text{see equation (7-107)}]$$

Where:

M_{gas} = generic emission molar mass [g/mol]

\dot{n}_{exh} = exhaust gas molar flow rate on a wet basis [mol/s]

\bar{x}_{gas} = mean gaseous emission molar fraction on a wet basis [mol/mol]

Δt = time duration of test interval

- (c) Batch sampling, regardless the flow rate is varying or constant, shall be calculated by means of equation (7-108):

$$m_{gas} = \frac{1}{f} \cdot M_{gas} \cdot \bar{x}_{gas} \sum_{i=1}^N \dot{n}_{exhi} \quad [\text{see equation (7-108)}]$$

Where:

M_{gas} = generic emission molar mass [g/mol]

\dot{n}_{exhi} = instantaneous exhaust gas molar flow rate on a wet basis [mol/s]

\bar{x}_{gas} = mean gaseous emission molar fraction on a wet basis [mol/mol]

f = data sampling rate [Hz]

N = number of measurements [-]

- (d) In case of diluted exhaust gas calculated values for mass of the pollutants shall be corrected by subtracting the mass of background emissions, due to dilution air:

(i) Firstly, the molar flow rate of dilution air n_{airdil} [mol/s] shall be determined over the test interval. This may be a measured quantity or a quantity calculated from the diluted exhaust gas flow and the flow-weighted mean fraction of dilution air in diluted exhaust gas, $\bar{x}_{dil/exh}$;

(ii) The total flow of dilution air n_{airdil} [mol] shall be multiplied by the mean concentration of background emission. This may be a time-weighted mean or a flow-weighted mean (e.g., a proportionally sampled background). The product of n_{airdil} and the mean concentration of a background emission is the total amount of a background emission;

(iii) If the result is a molar quantity, it shall be converted to a mass of the background emission $m_{bk\text{gnd}}$ [g] by multiplying it by emission molar mass, M_{gas} [g/mol];

(iv) Total background mass shall be subtracted from total mass to correct for background emissions;

(v) The total flow of dilution air may be determined by a direct flow measurement. In this case, the total mass of background shall be calculated, using the dilution air flow, n_{airdil} . The background mass shall be subtracted from the total mass. The result shall be used in brake-specific emission calculations;

▼ M2

- (vi) The total flow of dilution air may be determined from the total flow of diluted exhaust gas and a chemical balance of the fuel, intake air, and exhaust gas as described in point 3.4. In this case, the total mass of background shall be calculated, using the total flow of diluted exhaust gas, n_{dexh} . Then this result shall be multiplied by the flow-weighted mean fraction of dilution air in diluted exhaust gas, $\bar{x}_{\text{dil/exh}}$.

Considering the two cases (v) and (vi), equations (7-115) and (7-116) shall be used:

$$m_{\text{bkngnd}} = M_{\text{gas}} \cdot x_{\text{gasdil}} \cdot n_{\text{airdil}} \quad \dot{\eta} \quad m_{\text{bkngnd}} = M_{\text{gas}} \cdot \bar{x}_{\text{dil/exh}} \cdot \bar{x}_{\text{bkngnd}} \cdot n_{\text{dexh}} \quad (7-115)$$

$$m_{\text{gascor}} = m_{\text{gas}} - m_{\text{bkngnd}} \quad (7-116)$$

where:

m_{gas} = total mass of the gaseous emission [g]

m_{bkngnd} = total background masses [g]

m_{gascor} = mass of gas corrected for background emissions [g]

M_{gas} = molecular mass of generic gaseous emission [g/mol]

x_{gasdil} = gaseous emission concentration in dilution air [mol/mol]

n_{airdil} = dilution air molar flow [mol]

$\bar{x}_{\text{dil/exh}}$ = flow-weighted mean fraction of dilution air in diluted exhaust gas [mol/mol]

\bar{x}_{bkngnd} = gas fraction of background [mol/mol]

n_{dexh} = total flow of diluted exhaust gas [mol]

▼ B

3.6.2. Dry-to wet concentration conversion

The same relations for raw gases (point 3.5.2) shall be used for dry-to-wet conversion on diluted samples. For dilution air a humidity measurement shall be performed with the aim to calculate its water vapour fraction $x_{\text{H2Odil}}^{\text{dry}}$ [mol/mol] by means of equation (7-96):

$$x_{\text{H2Odil}}^{\text{dry}} = \frac{x_{\text{H2Odil}}}{1 - x_{\text{H2Odil}}} \quad \text{[(see equation (7-96))]}$$

Where:

x_{H2Odil} = water molar fraction in the dilution air flow [mol/mol]

3.6.3. Exhaust gas molar flow rate

(a) Calculation via chemical balance;

The molar flow rate \dot{n}_{exh} [mol/s] can be calculated based on fuel mass flow rate \dot{m}_{fuel} by means of equation (7-113):

$$\dot{n}_{\text{exh}} = \frac{\dot{m}_{\text{fuel}} \cdot w_{\text{C}} \cdot (1 + x_{\text{H2Oexhdry}})}{M_{\text{C}} \cdot x_{\text{Ccombdry}}} \quad \text{(see equation 7-113)}$$

▼ B

Where:

\dot{n}_{exh} = raw exhaust gas molar flow rate from which emissions are measured

\dot{m}_{fuel} = fuel flow rate including humidity in intake air [g/s]

w_{C} = carbon mass fraction for the given fuel [g/g]

$x_{\text{H}_2\text{Oexhdry}}$ = amount of H₂O per dry mole of measured flow [mol/mol]

M_{C} = molecular mass of carbon 12,0107 g/mol

x_{Ccombdry} = amount of carbon from fuel in the exhaust gas per mole of dry exhaust gas [mol/mol]

(b) Measurement

The exhaust gas molar flow rate may be measured by means of three systems:

- (i) ► **M2** PDP molar flow rate. Based upon the speed at which the Positive Displacement Pump (PDP) operates for a test interval, the corresponding slope a_1 , and intercept, a_0 [-], as calculated with the calibration procedure set out in point 3.9.2, shall be used to calculate molar flow rate \dot{n} [mol/s] by means of equation (7-117): ◀

$$\dot{n} = f_{\text{n,PDP}} \cdot \frac{p_{\text{in}} \cdot V_{\text{rev}}}{R \cdot T_{\text{in}}} \quad (7-117)$$

with:

$$V_{\text{rev}} = \frac{a_1}{f_{\text{n,PDP}} \cdot \sqrt{\frac{p_{\text{out}} - p_{\text{in}}}{p_{\text{in}}} + a_0}} \quad (7-118)$$

where:

a_1 = calibration coefficient [m³/s]

a_0 = calibration coefficient [m³/rev]

$p_{\text{in}}, p_{\text{out}}$ = inlet/outlet pressure [Pa]

R = molar gas constant [J/(mol · K)]

T_{in} = inlet temperature [K]

V_{rev} = PDP pumped volume [m³/rev]

$f_{\text{n,PDP}}$ = PDP speed [rev/s]

- (ii) ► **M2** SSV molar flow rate. Based on the C_d versus $R_e^{\#}$ equation determined in accordance with point 3.9.4, the Sub-Sonic Venturi (SSV) molar flow rate during an emission test \dot{n} [mol/s] shall be calculated by means of equation (7-119): ◀

$$\dot{n} = C_d \cdot C_f \cdot \frac{A_t \cdot p_{\text{in}}}{\sqrt{Z \cdot M_{\text{mix}} \cdot R \cdot T_{\text{in}}}} \quad (7-119)$$

Where:

p_{in} = inlet pressure [Pa]

A_t = Venturi throat cross-sectional area [m²]

R = molar gas constant [J/(mol · K)]

T_{in} = inlet temperature [K]

Z = compressibility factor

▼B

M_{mix} = molar mass of diluted exhaust gas [kg/mol]

C_d = discharge coefficient of the SSV [-]

C_f = flow coefficient of the SSV [-]

- (iii) ► **M2** CFV molar flow rate. To calculate the molar flow rate through one venturi or one combination of venturis, its respective mean C_d and other constants, determined in accordance with point 3.9.5, shall be used. The calculation of its molar flow rate \dot{n} [mol/s] during an emission test shall be calculated by means of equation (7-120): ◀

$$\dot{n} = C_d \cdot C_f \cdot \frac{A_t \cdot p_{\text{in}}}{\sqrt{Z \cdot M_{\text{mix}} \cdot R \cdot T_{\text{in}}}} \quad (7-120)$$

Where:

p_{in} = inlet pressure [Pa]

A_t = Venturi throat cross-sectional area [m²]

R = molar gas constant [J/(mol · K)]

T_{in} = inlet temperature [K]

Z = compressibility factor

M_{mix} = molar mass of diluted exhaust gas [kg/mol]

C_d = discharge coefficient of the CFV [-]

C_f = flow coefficient of the CFV [-]

3.7. Determination of particulates

3.7.1. Sampling

- (a) Sampling from a varying flow rate:

If a batch sample from a changing exhaust gas flow rate is collected, a sample proportional to the changing exhaust gas flow rate shall be extracted. The flow rate shall be integrated over a test interval to determine the total flow. The mean PM concentration \overline{M}_{PM} (which is already in units of mass per mole of sample) shall be multiplied by the total flow to obtain the total mass of PM m_{PM} [g] by means of equation (7-121):

$$m_{\text{PM}} = \overline{M}_{\text{PM}} \cdot \sum_{i=1}^N (\dot{n}_i \cdot \Delta t_i) \quad (7-121)$$

Where:

\dot{n}_i = instantaneous exhaust gas molar flow rate [mol/s]

\overline{M}_{PM} = mean PM concentration [g/mol]

Δt_i = sampling interval [s]

- (b) Sampling from a constant flow rate

If a batch sample from a constant exhaust gas flow rate is collected, the mean molar flow rate from which the sample is extracted shall be determined. The mean PM concentration shall be multiplied by the total flow to obtain the total mass of PM m_{PM} [g] by means of equation (7-122):

$$m_{\text{PM}} = \overline{M}_{\text{PM}} \cdot \dot{n} \cdot \Delta t \quad (7-122)$$

▼ B

where:

\dot{n} = exhaust gas molar flow rate [mol/s]

\overline{M}_{PM} = mean PM concentration [g/mol]

Δt = time duration of test interval [s]

For sampling with a constant dilution ratio (DR), m_{PM} [g] shall be calculated by means of equation (7-123):

$$m_{\text{PM}} = m_{\text{PMdil}} \cdot DR \quad (7-123)$$

where:

m_{PMdil} = PM mass in dilution air [g]

DR = dilution ratio [-] defined as the ratio between the mass of the emission m and the mass of diluted exhaust gas $m_{\text{dil/exh}}$ ($DR = m/m_{\text{dil/exh}}$).

The dilution ratio DR can be expressed as a function of $x_{\text{dil/exh}}$ [equation (7-124)]:

$$DR = \frac{1}{1 - x_{\text{dil/exh}}} \quad (7-124)$$

3.7.2. Background correction

The same approach as that of point 3.6.1 shall be applied to correct the mass of PM for the background. Multiplying $\overline{M}_{\text{PMbkgnd}}$ by the total flow of dilution air, the total background mass of PM (m_{PMbkgnd} [g]) is obtained. Subtraction of total background mass from total mass gives background corrected mass of particulates m_{PMcor} [g] [equation (7-125)]:

$$m_{\text{PMcor}} = m_{\text{PMuncor}} - \overline{M}_{\text{PMbkgnd}} \cdot n_{\text{airdil}} \quad (7-125)$$

where:

m_{PMuncor} = uncorrected PM mass [g]

$\overline{M}_{\text{PMbkgnd}}$ = mean PM concentration in dilution air [g/mol]

n_{airdil} = dilution air molar flow [mol]

3.8. Cycle work and specific emissions

3.8.1. Gaseous emissions

3.8.1.1. Transient (NRTC and LSI-NRTC) test cycles and RMC

Reference is made to points 3.5.1 and 3.6.1 for raw and diluted exhaust gas respectively. The resulting values for power P_i [kW] shall be integrated over a test interval. The total work W_{act} [kWh] shall be calculated by means of equation (7-126):

▼ M2

$$W_{\text{act}} = \sum_{i=1}^N P_i \cdot \Delta t_i = \frac{1}{f} \cdot \frac{1}{3600} \cdot \frac{1}{10^3} \cdot \frac{2 \cdot \pi}{60} \cdot \sum_{i=1}^N (n_i \cdot T_i) \quad (7-126)$$

▼ B

Where:

P_i = instantaneous engine power [kW]

n_i = instantaneous engine speed [rpm]

T_i = instantaneous engine torque [N·m]

▼ B

W_{act} = actual cycle work [kWh]

f = data sampling rate [Hz]

N = number of measurements [-]

▼ M2

Δt_i = the measurement interval [s]

▼ B

Where auxiliaries were fitted in accordance with Appendix 2 of Annex VI there shall be no adjustment to the instantaneous engine torque in equation (7-126). Where, according to points 6.3.2 or 6.3.3 of Annex VI to this regulation necessary auxiliaries that should have been fitted for the test are not installed, or auxiliaries that should have been removed for the test are installed, the value of T_i used in equation (7-126) shall be adjusted by means of equation (7-127):

$$T_i = T_{i,\text{meas}} + T_{i,\text{AUX}} \quad (7-127)$$

▼ M2

Where:

$T_{i,\text{meas}}$ is the measured value of instantaneous engine torque

$T_{i,\text{AUX}}$ is the corresponding value of torque required to drive auxiliaries determined in accordance with point 7.7.2.3(b) of Annex VI.

▼ B

The specific emissions e_{gas} [g/kWh] shall be calculated in the following ways depending on the type of test cycle.

$$e_{\text{gas}} = \frac{m_{\text{gas}}}{W_{\text{act}}} \quad (7-128)$$

where:

m_{gas} = total mass of emission [g/test]

W_{act} = cycle work [kWh]

In case of the NRTC, for gaseous emissions other than CO₂ the final test result e_{gas} [g/kWh] shall be a weighted average from cold-start run and hot-start run calculated by means of equation (7-129):

$$e_{\text{gas}} = \frac{(0,1 \cdot m_{\text{cold}}) + (0,9 \cdot m_{\text{hot}})}{(0,1 \cdot W_{\text{act,cold}}) + (0,9 \cdot W_{\text{act,hot}})} \quad (7-129)$$

Where:

m_{cold} is the gas mass emissions of the cold-start NRTC [g]

$W_{\text{act, cold}}$ is the actual cycle work of the cold-start NRTC [kWh]

m_{hot} is the gas mass emissions of the hot-start NRTC [g]

$W_{\text{act, hot}}$ is the actual cycle work of the hot-start NRTC [kWh]

In case of the NRTC, for CO₂ the final test result e_{CO_2} [g/kWh] shall be calculated from the hot-start NRTC calculated by means of equation (7-130):

$$e_{\text{CO}_2,\text{hot}} = \frac{m_{\text{CO}_2,\text{hot}}}{W_{\text{act,hot}}} \quad (7-130)$$

Where:

$m_{\text{CO}_2, \text{hot}}$ is the CO₂ mass emissions of the hot-start NRTC [g]

$W_{\text{act, hot}}$ is the actual cycle work of the hot-start NRTC [kWh]

▼ B

3.8.1.2. Discrete-mode NRSC

The specific emissions e_{gas} [g/kWh] shall be calculated by means of equation (7-131):

$$e_{\text{gas}} = \frac{\sum_{i=1}^{N_{\text{mode}}} (\dot{m}_{\text{gas},i} \cdot WF_i)}{\sum_{i=1}^{N_{\text{mode}}} (P_i \cdot WF_i)} \quad (7-131)$$

where:

$\dot{m}_{\text{gas},i}$ = mean emission mass flow rate for the mode i [g/h]

▼ M2

P_i = engine power for the mode i [kW] calculated by adding to the measured power P_{meas} [kW] the power required to drive auxiliaries P_{AUX} [kW] determined in accordance with equation (6-8) of Annex VI ($P_i = P_{\text{meas}} + P_{\text{AUX}}$)

▼ B

WF_i = weighting factor for the mode i [-]

▼ M2

N_{mode} = number of modes in applicable discrete-mode NRSC

▼ B

3.8.2. Particulate emissions

3.8.2.1. Transient (NRTC and LSI-NRTC) test cycles and RMC

The particulate specific emissions shall be calculated by transforming equation (7-128) into equation (7-132) where e_{gas} [g/kWh] and m_{gas} [g/test] are substituted by e_{PM} [g/kWh] and m_{PM} [g/test] respectively:

$$e_{\text{PM}} = \frac{m_{\text{PM}}}{W_{\text{act}}} \quad (7-132)$$

Where:

m_{PM} = total mass of particulates emission, calculated according to point 3.7.1 [g/test]

W_{act} = cycle work [kWh]

The emissions on the transient composite cycle (i.e. cold-start NRTC and hot-start NRTC) shall be calculated as shown in point 3.8.1.1.

3.8.2.2. Discrete-mode NRSC

The particulate specific emission e_{PM} [g/kWh] shall be calculated in the following way:

3.8.2.2.1. For the single-filter method by means of equation (7-133):

▼ M2

$$e_{\text{PM}} = \frac{\dot{m}_{\text{PM}}}{\sum_{i=1}^{N_{\text{mode}}} (P_i \cdot WF_i)} \quad (7-133)$$

▼ B

Where:

▼ M2

P_i = engine power for the mode i [kW] calculated by adding to the measured power P_{meas} [kW] the power required to drive auxiliaries P_{AUX} [kW] determined in accordance with equation (6-8) of Annex VI ($P_i = P_{\text{meas}} + P_{\text{AUX}}$).

▼ B

WF_i = weighting factor for the mode i [-]

\dot{m}_{PM} = particulate mass flow rate [g/h]

▼ M2

N_{mode} = number of modes in applicable discrete-mode NRSC

▼ B

3.8.2.2.2. For the multiple-filter method by means of equation (7-134):

▼ M2

$$e_{PM} = \frac{\sum_{i=1}^{N_{mode}} (\dot{m}_{PMi} \cdot WF_i)}{\sum_{i=1}^{N_{mode}} (P_i \cdot WF_i)} \quad (7-134)$$

▼ B

Where:

▼ M2

P_i = engine power for the mode i [kW] calculated by adding to the measured power P_{meas} [kW] the power required to drive auxiliaries P_{AUX} [kW] determined in accordance with equation (6-8) of Annex VI ($P_i = P_{meas} + P_{AUX}$).

▼ B

WF_i = weighting factor for the mode i [-]

\dot{m}_{PMi} = particulate mass flow rate at mode i [g/h]

▼ M2

N_{mode} = number of modes in applicable discrete-mode NRSC

▼ B

For the single-filter method, the effective weighting factor, WF_{effi} , for each mode shall be calculated by means of equation (7-135):

$$WF_{effi} = \frac{m_{smpldexhi} \cdot \overline{\dot{m}}_{eqdexhwet}}{m_{smpldex} \cdot \dot{m}_{eqdexhweti}} \quad (7-135)$$

Where:

$m_{smpldexhi}$ = mass of the diluted exhaust gas sample passed through the particulate sampling filters at mode i [kg]

$m_{smpldex}$ = mass of the diluted exhaust gas sample passed through the particulate sampling filters [kg]

$\dot{m}_{eqdexhweti}$ = equivalent diluted exhaust gas mass flow rate at mode i [kg/s]

$\overline{\dot{m}}_{eqdexhwet}$ = average equivalent diluted exhaust gas mass flow rate [kg/s]

The value of the effective weighting factors shall be within 0,005 (absolute value) of the weighting factors listed in Appendix 1 of Annex XVII.

3.8.3. Adjustment for emission controls that are regenerated on an infrequent (periodic) basis

In case of engines, other than those of category RLL, equipped with exhaust after-treatment systems that are regenerated on an infrequent (periodic) basis (see point 6.6.2 of Annex VI), the specific emissions of gaseous and particulate pollutants calculated according to points 3.8.1 and 3.8.2 shall be corrected with either the applicable multiplicative adjustment factor or with the applicable additive adjustment factor. In the case that infrequent regeneration did not take place during the test the upward factor shall be applied ($k_{ru,m}$ or $k_{ru,a}$). In the case that infrequent regeneration took place during the test the downward factor shall be applied ($k_{rd,m}$ or $k_{rd,a}$). In the case of the discrete-mode NRSC, where the adjustment factors have been determined for each mode they shall be applied to each mode during the calculation of the weighted emission result.

3.8.4. Adjustment for deterioration factor

The specific emissions of gaseous and particulate pollutants calculated according to points 3.8.1 and 3.8.2, where applicable inclusive of the infrequent regeneration adjustment factor according to point 3.8.3, shall also be adjusted by the applicable multiplicative or additive deterioration factor established according to the requirements of Annex III.

3.9. Diluted Exhaust Flow (CVS) Calibration and Related Calculations

This section describes the calculations for calibrating various flow meters. Point 3.9.1 first describes how to convert reference flow meter outputs for use in the calibration equations, which are presented on a

▼ B

molar basis. The remaining points describe the calibration calculations that are specific to certain types of flow meters.

3.9.1. Reference meter conversions

The calibration equations in this section use molar flow rate, \dot{n}_{ref} , as a reference quantity. If the adopted reference meter outputs a flow rate in a different quantity, such as standard volume rate, \dot{V}_{stdref} actual volume rate, \dot{V}_{actdref} , or mass rate, \dot{m}_{ref} , the reference meter output shall be converted to a molar flow rate by means of equations (7-136), (7-137) and (7-138), noting that while values for volume rate, mass rate, pressure, temperature, and molar mass may change during an emission test, they should be kept as constant as practical for each individual set point during a flow meter calibration:

$$\dot{n}_{\text{ref}} = \frac{\dot{V}_{\text{stdref}} \cdot p_{\text{std}}}{T_{\text{std}} \cdot R} = \frac{\dot{V}_{\text{actdref}} \cdot p_{\text{act}}}{T_{\text{act}} \cdot R} = \frac{\dot{m}_{\text{ref}}}{M_{\text{mix}}} \quad (7-136)$$

where:

\dot{n}_{ref} = reference molar flow rate [mol/s]

\dot{V}_{stdref} = reference volume flow rate, corrected to a standard pressure and a standard temperature [m³/s]

\dot{V}_{actdref} = reference volume flow rate, at the actual pressure and temperature [m³/s]

\dot{m}_{ref} = reference mass flow [g/s]

p_{std} = standard pressure [Pa]

p_{act} = actual pressure of the gas [Pa]

T_{std} = standard temperature [K]

T_{act} = actual temperature of the gas [K]

R = molar gas constant [J/(mol · K)]

M_{mix} = molar mass of the gas [g/mol]

3.9.2. PDP calibration calculations

For each restrictor position, the following values shall be calculated from the mean values determined in point 8.1.8.4 of Annex VI, as follows:

(a) PDP volume pumped per revolution, V_{rev} (m³/rev):

$$V_{\text{rev}} = \frac{\bar{\dot{n}}_{\text{ref}} \cdot R \cdot \bar{T}_{\text{in}}}{\bar{p}_{\text{in}} \cdot \bar{f}_{n\text{PDP}}} \quad (7-137)$$

where:

$\bar{\dot{n}}_{\text{ref}}$ = mean value of reference molar flow rate [mol/s]

R = molar gas constant [J/(mol · K)]

\bar{T}_{in} = mean inlet temperature [K]

\bar{p}_{in} = mean inlet pressure [Pa]

$\bar{f}_{n\text{PDP}}$ = mean rotational speed [rev/s]

(b) PDP slip correction factor, K_s [s/rev]:

$$K_s = \frac{1}{\bar{f}_{n\text{PDP}} \cdot \sqrt{\frac{\bar{p}_{\text{out}} - \bar{p}_{\text{in}}}{\bar{p}_{\text{out}}}}} \quad (7-138)$$

Where:

$\bar{\dot{n}}_{\text{ref}}$ = mean reference molar flow rate [mol/s]

▼ B

\bar{T}_{in} = mean inlet temperature [K]

\bar{P}_{in} = mean inlet pressure [Pa]

\bar{P}_{out} = mean outlet pressure [Pa]

\bar{f}_{nPDP} = mean PDP revolution speed [rev/s]

R = molar gas constant [J/(mol · K)]

- (c) A least-squares regression of PDP volume pumped per revolution, V_{rev} , versus PDP slip correction factor, K_s , shall be performed by calculating slope, a_1 , and intercept, a_0 , as described in Appendix 4;
- (d) The procedure in subparagraphs (a) to (c) of this point shall be repeated for every speed that PDP is operated;
- (e) Table 7.4 illustrates these calculations for different values of \bar{f}_{nPDP} :

Table 7.4

Example of PDP calibration data

\bar{f}_{nPDP} [rev/min]	\bar{f}_{nPDP} [rev/s]	a_1 [m ³ /min]	a_1 [m ³ /s]	a_0 [m ³ /rev]
755,0	12,58	50,43	0,8405	0,056
987,6	16,46	49,86	0,831	- 0,013
1 254,5	20,9	48,54	0,809	0,028
1 401,3	23,355	47,30	0,7883	- 0,061

- (f) For each speed at which the PDP is operated, the corresponding slope, a_1 , and intercept, a_0 , shall be used to calculate flow rate during emission testing as described in point 3.6.3(b).

3.9.3. Venturi governing equations and permissible assumptions

This section describes the governing equations and permissible assumptions for calibrating a venturi and calculating flow using a venturi. Because a subsonic venturi (SSV) and a critical-flow venturi (CFV) both operate similarly, their governing equations are nearly the same, except for the equation describing their pressure ratio, r (i.e., r_{SSV} versus r_{CFV}). These governing equations assume one-dimensional isentropic inviscid compressible flow of an ideal gas. In point 3.9.3(d), other assumptions that may be made are described. If the assumption of an ideal gas for the measured flow is not allowed, the governing equations include a first-order correction for the behaviour of a real gas; namely, the compressibility factor, Z . If good engineering judgment dictates using a value other than $Z = 1$, an appropriate equation of state to determine values of Z as a function of measured pressures and temperatures may be used, or specific calibration equations may be developed based on good engineering judgment. It shall be noted that the equation for the flow coefficient, C_F , is based on the ideal gas assumption that the isentropic exponent, γ , is equal to the ratio of specific heats, c_p/c_v . If good engineering judgment dictates using a real gas isentropic exponent, an appropriate equation of state to determine values of γ as a function of measured pressures and temperatures may be used, or specific calibration equations may be developed. Molar flow rate, \dot{n} [mol/s], shall be calculated by means of equation (7-139):

▼ B

$$\dot{n} = C_d \cdot C_f \cdot \frac{A_t \cdot p_{in}}{\sqrt{Z \cdot M_{mix} \cdot R \cdot T_{in}}} \quad (7-139)$$

Where:

C_d = Discharge coefficient, as determined in point 3.9.3(a) [-]

C_f = Flow coefficient, as determined in point 3.9.3(b) [-]

A_t = Venturi throat cross-sectional area [m²]

p_{in} = Venturi inlet absolute static pressure [Pa]

Z = Compressibility factor [-]

M_{mix} = Molar mass of gas mixture [kg/mol]

R = Molar gas constant [J/(mol · K)]

T_{in} = Venturi inlet absolute temperature [K]

- (a) Using the data collected in point 8.1.8.4 of Annex VI, C_d is calculated by means of equation (7-140):

▼ M2

$$C_d = \dot{n}_{ref} \cdot \frac{\sqrt{Z \cdot M_{mix} \cdot R \cdot T_{in}}}{C_f \cdot A_t \cdot p_{in}} \quad (7-140)$$

▼ B

Where:

\dot{n}_{ref} = reference molar flow rate [mol/s]

Other symbols as per equation (7-139).

- (b) C_f shall be determined using one of the following methods:

- (i) For CFV flow meters only, C_{fCFV} is derived from Table 7.5 based on values for β (ratio of venturi throat to inlet diameters) and γ (ratio of specific heats of the gas mixture), using linear interpolation to find intermediate values:

Table 7.5

C_{fCFV} versus β and γ for CFV flow meters

C_{fCFV}		
β	$\gamma_{exh} = 1,385$	$\gamma_{dexh} = \gamma_{air} = 1,399$
0,000	0,6822	0,6846
0,400	0,6857	0,6881
0,500	0,6910	0,6934
0,550	0,6953	0,6977
0,600	0,7011	0,7036
0,625	0,7047	0,7072
0,650	0,7089	0,7114
0,675	0,7137	0,7163
0,700	0,7193	0,7219
0,720	0,7245	0,7271

▼B

C_{fCFV}		
β	$\gamma_{exh} = 1,385$	$\gamma_{dexh} = \gamma_{air} = 1,399$
0,740	0,7303	0,7329
0,760	0,7368	0,7395
0,770	0,7404	0,7431
0,780	0,7442	0,7470
0,790	0,7483	0,7511
0,800	0,7527	0,7555
0,810	0,7573	0,7602
0,820	0,7624	0,7652
0,830	0,7677	0,7707
0,840	0,7735	0,7765
0,850	0,7798	0,7828

- (ii) For any CFV or SSV flow meter, equation (7-141) may be used to calculate C_f :

$$C_f = \left[\frac{2 \cdot \gamma \cdot (r^{\frac{\gamma-1}{\gamma}} - 1)}{(\gamma - 1) \cdot (\beta^4 - r^{\frac{2}{\gamma}})} \right]^{\frac{1}{2}} \quad (7-141)$$

Where:

γ = isentropic exponent [-]. For an ideal gas, this is the ratio of specific heats of the gas mixture, c_p/c_v

r = pressure ratio, as determined in paragraph (c)(3) of this point

β = ratio of venturi throat to inlet diameters

- (c) The pressure ratio r shall be calculated as follows:

- (i) For SSV systems only, r_{SSV} shall be calculated by means of equation (7-142):

$$r_{SSV} = 1 - \frac{\Delta p_{SSV}}{p_{in}} \quad (7-142)$$

Where:

Δp_{SSV} = differential static pressure; venturi inlet minus venturi throat [Pa]

- (ii) For CFV systems only, r_{CFV} shall be calculated iteratively by means of equation (7-143):

$$r_{CFV}^{\frac{1-\gamma}{\gamma}} + \left(\frac{\gamma-1}{2} \right) \cdot \beta^4 \cdot r_{CFV}^{\frac{2}{\gamma}} = \frac{\gamma+1}{2} \quad (7-143)$$

- (d) Any of the following simplifying assumptions of the governing equations may be made, or good engineering judgment may be used to develop more appropriate values for testing:

- (i) For emission testing over the full ranges of raw exhaust gas, diluted exhaust gas and dilution air, the gas mixture may be assumed to behave as an ideal gas: $Z = 1$;

▼B

- (ii) For the full range of raw exhaust gas a constant ratio of specific heats of $\gamma = 1,385$ may be assumed;
- (iii) For the full range of diluted exhaust gas and air (e.g., calibration air or dilution air), a constant ratio of specific heats of $\gamma = 1,399$ may be assumed;
- (iv) For the full range of diluted exhaust gas and air, the molar mass of the mixture, M_{mix} [g/mol], may be considered as a function only of the amount of water in the dilution air or calibration air, $x_{\text{H}_2\text{O}}$, determined as described in point 3.3.2 and shall be calculated by means of equation (7-144):

$$M_{\text{mix}} = M_{\text{air}} \cdot (1 - x_{\text{H}_2\text{O}}) + M_{\text{H}_2\text{O}} \cdot (x_{\text{H}_2\text{O}}) \quad (7-144)$$

Where:

$$M_{\text{air}} = 28,96559 \text{ g/mol}$$

$$M_{\text{H}_2\text{O}} = 18,01528 \text{ g/mol}$$

$$x_{\text{H}_2\text{O}} = \text{amount of water in the dilution or calibration air} \\ \text{[mol/mol]}$$

- (v) For the full range of diluted exhaust gas and air, a constant molar mass of the mixture, M_{mix} , may be assumed for all calibration and all testing as long as assumed molar mass differs no more than $\pm 1\%$ from the estimated minimum and maximum molar mass during calibration and testing. This assumption may be made if sufficient control of the amount of water in calibration air and in dilution air is ensured, or if sufficient water is removed from both calibration air and dilution air. Table 7.6 provides for examples of permissible ranges of dilution air dew point versus calibration air dew point:

Table 7.6

Examples of dilution air and calibration air dew points at which a constant M_{mix} may be assumed

If calibration T_{dew} (°C) is ...	the following constant M_{mix} (g/mol) is assumed	for the following ranges of T_{dew} (°C) during emission tests ^(a)
dry	28,96559	dry to 18
0	28,89263	dry to 21
5	28,86148	dry to 22
10	28,81911	dry to 24
15	28,76224	dry to 26
20	28,68685	- 8 to 28
25	28,58806	12 to 31
30	28,46005	23 to 34

^(a) Range valid for all calibration and emission testing over the atmospheric pressure range (80,000 to 103,325) kPa.

▼ B

3.9.4. SSV calibration

(a) Molar based approach. To calibrate an SSV flow meter the following steps shall be performed:

- (i) The Reynolds number, $Re^\#$, for each reference molar flow rate, shall be calculated using the throat diameter of the venturi, d_t [equation (7-145)]. Because the dynamic viscosity, μ , is needed to compute $Re^\#$, a specific viscosity model may be used to determine μ for calibration gas (usually air), using good engineering judgment [equation (7-146)]. Alternatively, the Sutherland three-coefficient viscosity model may be used to approximate μ (see Table 7.7):

$$Re^\# = \frac{4 \cdot M_{\text{mix}} \cdot \dot{n}_{\text{ref}}}{\pi \cdot d_t \cdot \mu} \quad (7-145)$$

Where:

d_t = diameter of the SSV throat [m]

M_{mix} = mixture molar mass [kg/mol]

\dot{n}_{ref} = reference molar flow rate [mol/s]

and, using the Sutherland three-coefficient viscosity model:

$$\mu = \mu_0 \left(\frac{T_{\text{in}}}{T_0} \right)^{\frac{3}{2}} \cdot \left(\frac{T_0 + S}{T_{\text{in}} + S} \right) \quad (7-146)$$

Where:

μ = Dynamic viscosity of calibration gas [kg/(m · s)]

μ_0 = Sutherland reference viscosity [kg/(m · s)]

S = Sutherland constant [K]

T_0 = Sutherland reference temperature [K]

T_{in} = Absolute temperature at the venturi inlet [K]

Table 7.7

Sutherland three-coefficient viscosity model parameters

Gas ^(a)	μ_0	T_0	S	Temp range within $\pm 2\%$ error	Pressure limit
	kg/(m · s)	K	K	K	kPa
Air	$1,716 \times 10^{-5}$	273	111	170 to 1 900	$\leq 1\,800$
CO ₂	$1,370 \times 10^{-5}$	273	222	190 to 1 700	$\leq 3\,600$
H ₂ O	$1,12 \times 10^{-5}$	350	1,064	360 to 1 500	$\leq 10\,000$
O ₂	$1,919 \times 10^{-5}$	273	139	190 to 2 000	$\leq 2\,500$
N ₂	$1,663 \times 10^{-5}$	273	107	100 to 1 500	$\leq 1\,600$

^(a) Tabulated parameters only for the pure gases, as listed, shall be used. Parameters to calculate viscosities of gas mixtures shall not be combined.

▼ B

- (ii) An equation for C_d versus $Re^\#$ shall be created, using paired values of ($Re^\#, C_d$). C_d is calculated according to equation (7-140), with C_f obtained from equation (7-141), or any mathematical expression may be used, including a polynomial or a power series. Equation (7-147) is an example of a commonly used mathematical expression for relating C_d and $Re^\#$,

$$C_d = a_0 - a_1 \cdot \sqrt{\frac{10^6}{Re}} \quad (7-147)$$

- (iii) A least-squares regression analysis shall be performed to determine the best-fit coefficients to the equation and calculate the equation's regression statistics, the standard estimate error SEE and the coefficient of determination r^2 , in accordance with Appendix 3;
- (iv) If the equation meets the criteria of $SEE < 0,5 \% n_{ref\ max}$ (or $\dot{m}_{ref\ max}$) and $r^2 \geq 0,995$, the equation may be used to determine C_d for emission tests, as described in point 3.6.3(b);
- (v) If the SEE and r^2 criteria are not met, good engineering judgment may be used to omit calibration data points to meet the regression statistics. At least seven calibration data points shall be used to meet the criteria;
- (vi) If omitting points does not resolve outliers, corrective action shall be taken. For example, another mathematical expression for the C_d versus $Re^\#$ equation shall be selected, leaks are to be checked, or the calibration process has to be repeated. If the process shall be repeated, tighter tolerances shall be applied to measurements and more time for flows to stabilize shall be allowed;
- (vii) Once the equation meets the regression criteria, the equation may be used only to determine flow rates that are within the range of the reference flow rates used to meet the C_d versus $Re^\#$ equation's regression criteria.

▼ M2

3.9.5. CFV calibration

Some CFV flow meters consist of a single venturi and some consist of multiple venturis, where different combinations of venturis are used to meter different flow rates. For CFV flow meters that consist of multiple venturis, either calibration of each venturi independently to determine a separate discharge coefficient, C_d , for each venturi, or calibration of each combination of venturis as one venturi may be performed. In the case where a combination of venturis is calibrated, the sum of the active venturi throat areas is used as A_t , the square root of the sum of the squares of the active venturi throat diameters as d_t , and the ratio of the venturi throat to inlet diameters is the ratio of the square root of the sum of the active venturi throat diameters (d_t) to the diameter of the common entrance to all of the venturis (D). To determine the C_d for a single venturi or a single combination of venturis, the following steps shall be performed:

▼ M2

- (a) With the data collected at each calibration set point an individual C_d for each point shall be calculated using equation (7-140);
- (b) The mean and standard deviation of all the C_d values shall be calculated in accordance with equations (7-155) and (7-156);
- (c) If the standard deviation of all the C_d values is less than or equal to 0,3 % of the mean C_d , then the mean C_d shall be used in equation (7-120), and the CFV shall be used only down to the lowest r measured during calibration;

$$r = 1 - (\Delta p/p_{in}) \quad (7-148)$$

- (d) If the standard deviation of all the C_d values exceeds 0,3 % of the mean C_d , the C_d values corresponding to the data point collected at the lowest r measured during calibration shall be omitted;
- (e) If the number of remaining data points is less than seven, corrective action shall be taken by checking calibration data or repeating the calibration process. If the calibration process is repeated, checking for leaks, applying tighter tolerances to measurements and allowing more time for flows to stabilize, is recommended;
- (f) If the number of remaining C_d values is seven or greater, the mean and standard deviation of the remaining C_d values shall be recalculated;
- (g) If the standard deviation of the remaining C_d values is less than or equal to 0,3 % of the mean of the remaining C_d , that mean C_d shall be used in equation (7-120) and the CFV values only down to the lowest r associated with the remaining C_d shall be used;
- (h) If the standard deviation of the remaining C_d still exceeds 0,3 % of the mean of the remaining C_d values, the steps set out in points (d) to (g) shall be repeated.



Appendix 1

Drift Correction

1. Scope and frequency

The calculations in this Appendix shall be performed to determine if gas analyzer drift invalidates the results of a test interval. If drift does not invalidate the results of a test interval, the test interval's gas analyzer responses shall be corrected for drift according to this Appendix. The drift-corrected gas analyzer responses shall be used in all subsequent emission calculations. The acceptable threshold for gas analyzer drift over a test interval is specified in point 8.2.2.2 of Annex VI.

2. Correction principles

The calculations in this Appendix utilize a gas analyzer's responses to reference zero and span concentrations of analytical gases, as determined sometime before and after a test interval. The calculations correct the gas analyzer's responses that were recorded during a test interval. The correction is based on an analyzer's mean responses to reference zero and span gases, and it is based on the reference concentrations of the zero and span gases themselves. Validation and correction for drift shall be performed as follows:

3. Drift validation

After applying all the other corrections—except drift correction—to all the gas analyzer signals, brake-specific emissions shall be calculated in accordance with point 3.8. Then all gas analyzer signals shall be corrected for drift according to this Appendix. Brake-specific emissions shall be recalculated using all of the drift-corrected gas analyzer signals. The brake-specific emission results shall be validated and reported before and after drift correction according to point 8.2.2.2 of Annex VI.

4. Drift correction

All gas analyzer signals shall be corrected as follows:

- (a) Each recorded concentration, x_i , shall be corrected for continuous sampling or for batch sampling, \bar{x} ;
- (b) Correction for drift shall be calculated by means of equation (7-149):

$$x_{\text{driftcor}} = x_{\text{refzero}} + (x_{\text{refspan}} - x_{\text{refzero}}) \frac{2x_i - (x_{\text{prezero}} + x_{\text{postzero}})}{(x_{\text{prespan}} + x_{\text{postspan}}) - (x_{\text{prezero}} + x_{\text{postzero}})} \quad (7-149)$$

Where:

x_{driftcor} = concentration corrected for drift [$\mu\text{mol/mol}$]

x_{refzero} = reference concentration of the zero gas, which is usually zero unless known to be otherwise [$\mu\text{mol/mol}$]

x_{refspan} = reference concentration of the span gas [$\mu\text{mol/mol}$]

x_{prespan} = pre-test interval gas analyzer response to the span gas concentration [$\mu\text{mol/mol}$]

x_{postspan} = post-test interval gas analyzer response to the span gas concentration [$\mu\text{mol/mol}$]

x_i or \bar{x} = concentration recorded, i.e. measured, during test, before drift correction [$\mu\text{mol/mol}$]

▼ B

x_{prezero} = pre-test interval gas analyzer response to the zero gas concentration [$\mu\text{mol/mol}$]

x_{postzero} = post-test interval gas analyzer response to the zero gas concentration [$\mu\text{mol/mol}$]

- (c) For any pre-test interval concentrations, concentrations determined most recently before the test interval shall be used. For some test intervals, the most recent pre-zero or pre-span might have occurred before one or more previous test intervals;
- (d) For any post-test interval concentrations, concentrations determined most recently after the test interval shall be used. For some test intervals, the most recent post-zero or post-span might have occurred after one or more subsequent test intervals;
- (e) If any pre-test interval analyzer response to the span gas concentration, x_{prespan} , is not recorded, x_{prespan} shall be set equal to the reference concentration of the span gas: $x_{\text{prespan}} = x_{\text{refspan}}$;
- (f) If any pre-test interval analyzer response to the zero gas concentration, x_{prezero} , is not recorded, x_{prezero} shall be set equal to the reference concentration of the zero gas: $x_{\text{prezero}} = x_{\text{refzero}}$;
- (g) Usually the reference concentration of the zero gas, x_{refzero} , is zero: $x_{\text{refzero}} = 0 \mu\text{mol/mol}$. However, in some cases it might be known that x_{refzero} has a non-zero concentration. For example, if a CO_2 analyzer is zeroed using ambient air, the default ambient air concentration of CO_2 , which is $375 \mu\text{mol/mol}$, may be used. In this case, $x_{\text{refzero}} = 375 \mu\text{mol/mol}$. When an analyzer is zeroed using a non-zero x_{refzero} , the analyzer shall be set to output the actual x_{refzero} concentration. For example, if $x_{\text{refzero}} = 375 \mu\text{mol/mol}$, the analyzer shall be set to output a value of $375 \mu\text{mol/mol}$ when the zero gas is flowing to the analyzer.

▼B*Appendix 2***Carbon Flow Check****1. Introduction**

All but a tiny part of the carbon in the exhaust gas comes from the fuel, and all but a minimal part of this is manifest in the exhaust gas as CO₂. This is the basis for a system verification check based on CO₂ measurements. In the case of SI engines without control of excess air ratio λ or SI engines operating outside the range $0,97 \leq \lambda \leq 1,03$, the procedure shall additionally include measurement of HC and CO.

The flow of carbon into the exhaust gas measurement systems is determined from the fuel flow rate. The flow of carbon at various sampling points in the emissions and particulate sampling systems is determined from the CO₂ (or CO₂, HC and CO) concentrations and gas flow rates at those points.

In this sense, the engine provides a known source of carbon flow, and observing the same carbon flow in the exhaust pipe and at the outlet of the partial flow PM sampling system verifies leak integrity and flow measurement accuracy. This check has the advantage that the components are operating under actual engine test conditions of temperature and flow.

Figure 7.1 shows the sampling points at which the carbon flows shall be checked. The specific equations for the carbon flows at each of the sample points are given in the following points.

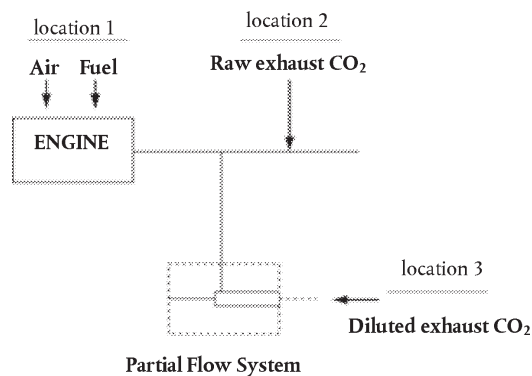
*Figure 7.1***Measuring points for carbon flow check****2. Carbon flow rate into the engine (location 1)**

The carbon mass flow rate into the engine q_{mCF} [kg/s] for a fuel CH _{α} O _{ϵ} shall be calculated by means of equation (7-150):

$$q_{mCF} = \frac{12,011}{12,011 + \alpha + 15,9994 \cdot \epsilon} \cdot g_{mf} \quad (7-150)$$

Where:

g_{mf} = fuel mass flow rate [kg/s]

▼ B**3. Carbon flow rate in the raw exhaust gas (location 2)****3.1. Based on CO₂**

The carbon mass flow rate in the exhaust pipe of the engine q_{mCe} [kg/s] shall be determined from the raw CO₂ concentration and the exhaust gas mass flow rate by means of equation (7-151):

$$q_{mCe} = \left(\frac{c_{CO_2,r} - c_{CO_2,a}}{100} \right) \cdot q_{mew} \cdot \frac{12,011}{M_e} \quad (7-151)$$

where:

$c_{CO_2,r}$ = wet CO₂ concentration in the raw exhaust gas [%]

$c_{CO_2,a}$ = wet CO₂ concentration in the ambient air [%]

q_{mew} = exhaust gas mass flow rate on wet basis [kg/s]

M_e = molar mass of exhaust gas [g/mol]

If CO₂ is measured on a dry basis it shall be converted to a wet basis in accordance with point 2.1.3 or point 3.5.2.

3.2. Based on CO₂, HC and CO

As an alternative to performing the calculation solely based upon CO₂ in point 3.1, the carbon mass flow rate in the exhaust pipe of the engine q_{mCe} [kg/s] shall be determined from the raw CO₂, HC and CO concentration and the exhaust gas mass flow rate by means of equation (7-152):

$$q_{mCe} = \left(\frac{c_{CO_2,r} - c_{CO_2,a}}{100} + \frac{c_{THC(C1),r} - c_{THC(C1),a}}{100} + \frac{c_{CO,r} - c_{CO,a}}{100} \right) \cdot q_{mew} \cdot \frac{12,011}{M_e} \quad (7-152)$$

Where:

$c_{CO_2,r}$ = wet CO₂ concentration in the raw exhaust gas [%]

$c_{CO_2,a}$ = wet CO₂ concentration in the ambient air [%]

$c_{THC(C1),r}$ = THC(C1) concentration in the raw exhaust gas [%]

$c_{THC(C1),a}$ = THC(C1) concentration in the ambient air [%]

$c_{CO,r}$ = wet CO concentration in the raw exhaust gas [%]

$c_{CO,a}$ = wet CO concentration in the ambient air [%]

q_{mew} = exhaust gas mass flow rate on wet basis [kg/s]

M_e = molar mass of exhaust gas [g/mol]

If CO₂ or CO are measured on a dry basis they shall be converted to a wet basis in accordance with point 2.1.3 or point 3.5.2.

▼ B**4. Carbon flow rate in the dilution system (location 3)****4.1. Based on CO₂**

For the partial flow dilution system, the splitting ratio also needs to be taken into account. The carbon flow rate in an equivalent dilution system q_{mCp} [kg/s] (with equivalent meaning equivalent to a full flow system where the total flow is diluted) shall be determined from the dilute CO₂ concentration, the exhaust gas mass flow rate and the sample flow rate; the new equation (7-153) is identical to equation (7-151), being only supplemented by the dilution factor q_{mdew}/q_{mp} .

$$q_{mCp} = \left(\frac{c_{CO_2,d} - c_{CO_2,a}}{100} \right) \cdot q_{mew} \cdot \frac{12,011}{M_e} \cdot \frac{q_{mdew}}{q_{mp}} \quad (7-153)$$

Where:

$c_{CO_2,d}$ = wet CO₂ concentration in the diluted exhaust gas at the outlet of the dilution tunnel [%]

$c_{CO_2,a}$ = wet CO₂ concentration in the ambient air [%]

q_{mdew} = diluted sample flow in the partial flow dilution system [kg/s]

q_{mew} = exhaust gas mass flow rate on wet basis [kg/s]

q_{mp} = sample flow of exhaust gas into partial flow dilution system [kg/s]

M_e = molar mass of exhaust gas [g/mol]

If CO₂ is measured on a dry basis it shall be converted to a wet basis in accordance with point 2.1.3 or point 3.5.2.

4.2. Based on CO₂, HC and CO

For the partial flow dilution system, the splitting ratio also needs to be taken into account. As an alternative to performing the calculation solely based upon CO₂ in point 4.1, the carbon flow rate in an equivalent dilution system q_{mCe} [kg/s] (with equivalent meaning equivalent to a full flow system where the total flow is diluted) shall be determined from the dilute CO₂, HC and CO concentrations, the exhaust gas mass flow rate and the sample flow rate; the new equation (7-154) is identical to equation (7-152), being only supplemented by the dilution factor q_{mdew}/q_{mp} .

$$q_{mCe} = \left(\frac{c_{CO_2,d} - c_{CO_2,a}}{100} + \frac{c_{THC(C1),d} - c_{THC(C1),a}}{100} + \frac{c_{CO,d} - c_{CO,a}}{100} \right) \cdot q_{mew} \cdot \frac{12,011}{M_e} \cdot \frac{q_{mdew}}{q_{mp}} \quad (7-154)$$

Where:

$c_{CO_2,d}$ = wet CO₂ concentration in the diluted exhaust gas at the outlet of the dilution tunnel [%]

$c_{CO_2,a}$ = wet CO₂ concentration in the ambient air [%]

$c_{THC(C1),d}$ = THC(C1) concentration in the diluted exhaust gas at the outlet of the dilution tunnel [%]

$c_{THC(C1),a}$ = THC(C1) concentration in the ambient air [%]

$c_{CO,d}$ = wet CO concentration in the diluted exhaust gas at the outlet of the dilution tunnel [%]

$c_{CO,a}$ = wet CO concentration in the ambient air [%]

▼ B

q_{mdew} = diluted sample flow in the partial flow dilution system [kg/s]

q_{mew} = exhaust gas mass flow rate on wet basis [kg/s]

q_{mp} = sample flow of exhaust gas into partial flow dilution system [kg/s]

M_e = molar mass of exhaust gas [g/mol]

If CO₂ or CO are measured on a dry basis they shall be converted to a wet basis in accordance with point 2.1.3 or point 3.5.2 of this Annex.

5. **Calculation of the molar mass of the exhaust gas**

The molar mass of the exhaust gas shall be calculated by means of equation (7-13) (see point 2.1.5.2. of this Annex).

Alternatively, the following exhaust gas molar masses may be used:

M_e (diesel) = 28,9 g/mol

M_e (LPG) = 28,6 g/mol

M_e (Natural gas/biomethane) = 28,3 g/mol

M_e (Petrol) = 29,0 g/mol

▼ **B**

Appendix 3

Statistics

1. Arithmetic mean

The arithmetic mean, \bar{y} , shall be calculated by means of equation (7-155):

$$\bar{y} = \frac{\sum_{i=1}^N y_i}{N} \quad (7-155)$$

2. Standard deviation

The standard deviation for a non-biased (e.g., $N-1$) sample, σ , shall be calculated by means of equation (7-156):

$$\sigma_y = \sqrt{\frac{\sum_{i=1}^N (y_i - \bar{y})^2}{(N - 1)}} \quad (7-156)$$

3. Root mean square

The root mean square, rms_y , shall be calculated by means of equation (7-157):

$$rms_y = \sqrt{\frac{1}{N} \sum_{i=1}^N y_i^2} \quad (7-157)$$

4. t-test

It shall be determined if the data passes a t-test by means of the following equations and Table 7.8:

- (a) For an unpaired t-test, the t statistic and its number of degrees of freedom, ν , shall be calculated by means of equations (7-158) and (7-159):

$$t = \frac{|\bar{y}_{\text{ref}} - \bar{y}|}{\sqrt{\frac{\sigma_{\text{ref}}^2}{N_{\text{ref}}} + \frac{\sigma_y^2}{N}}} \quad (7-158)$$

$$\nu = \frac{\left(\frac{\sigma_{\text{ref}}^2}{N_{\text{ref}}} + \frac{\sigma_y^2}{N}\right)^2}{\frac{(\sigma_{\text{ref}}^2/N_{\text{ref}})^2}{N_{\text{ref}}-1} + \frac{(\sigma_y^2/N)^2}{N-1}} \quad (7-159)$$

- (b) For a paired t-test, the t statistic and its number of degrees of freedom, ν , shall be calculated by means of equation (7-160), noting that the ε_i are the errors (e.g., differences) between each pair of $y_{\text{ref}i}$ and y_i :

$$t = \frac{|\bar{\varepsilon}| \cdot \sqrt{N}}{\sigma_{\varepsilon}} \quad \nu = N - 1 \quad (7-160)$$

- (c) Table 7.8 shall be used to compare t to the t_{crit} values tabulated versus the number of degrees of freedom. If t is less than t_{crit} , then t passes the t-test.

Table 7.8

Critical t values versus number of degrees of freedom, ν

ν	Confidence	
	90 %	95 %
1	6,314	12,706
2	2,920	4,303
3	2,353	3,182

▼B

v	Confidence	
	4	2,132
5	2,015	2,571
6	1,943	2,447
7	1,895	2,365
8	1,860	2,306
9	1,833	2,262
10	1,812	2,228
11	1,796	2,201
12	1,782	2,179
13	1,771	2,160
14	1,761	2,145
15	1,753	2,131
16	1,746	2,120
18	1,734	2,101
20	1,725	2,086
22	1,717	2,074
24	1,711	2,064
26	1,706	2,056
28	1,701	2,048
30	1,697	2,042
35	1,690	2,030
40	1,684	2,021
50	1,676	2,009
70	1,667	1,994
100	1,660	1,984
1 000+	1,645	1,960

Linear interpolation shall be used to establish values not shown here.

5. F-test

The F statistic shall be calculated by means of equation (7-161):

$$F_y = \frac{\sigma_y^2}{\sigma_{\text{ref}}^2} \quad (7-161)$$

- (a) For a 90 % confidence F -test, Table 7.9 is used to compare F to the $F_{\text{crit}90}$ values tabulated versus $(N-1)$ and $(N_{\text{ref}}-1)$. If F is less than $F_{\text{crit}90}$, then F passes the F -test at 90 % confidence;
- (b) For a 95 % confidence F -test, Table 7.10 is used to compare F to the $F_{\text{crit}95}$ values tabulated versus $(N-1)$ and $(N_{\text{ref}}-1)$. If F is less than $F_{\text{crit}95}$, then F passes the F -test at 95 % confidence.

Table 7-9

Critical F values, F_{crit90} , versus $N - 1$ and $N_{ref} - 1$ at 90 per cent confidence

$N - 1$	1	2	3	4	5	6	7	8	9	10	12	15	20	24	30	40	60	120	1000+
$N_{ref} - 1$																			
1	39,86	49,50	53,59	55,83	57,24	58,20	58,90	59,43	59,85	60,19	60,70	61,22	61,74	62,00	62,26	62,52	62,79	63,06	63,32
2	8,526	9,000	9,162	9,243	9,293	9,326	9,349	9,367	9,381	9,392	9,408	9,425	9,441	9,450	9,458	9,466	9,475	9,483	9,491
3	5,538	5,462	5,391	5,343	5,309	5,285	5,266	5,252	5,240	5,230	5,216	5,200	5,184	5,176	5,168	5,160	5,151	5,143	5,134
4	4,545	4,325	4,191	4,107	4,051	4,010	3,979	3,955	3,936	3,920	3,896	3,870	3,844	3,831	3,817	3,804	3,790	3,775	3,761
5	4,060	3,780	3,619	3,520	3,453	3,405	3,368	3,339	3,316	3,297	3,268	3,238	3,207	3,191	3,174	3,157	3,140	3,123	3,105
6	3,776	3,463	3,289	3,181	3,108	3,055	3,014	2,983	2,958	2,937	2,905	2,871	2,836	2,818	2,800	2,781	2,762	2,742	2,722
7	3,589	3,257	3,074	2,961	2,883	2,827	2,785	2,752	2,725	2,703	2,668	2,632	2,595	2,575	2,555	2,535	2,514	2,493	2,471
8	3,458	3,113	2,924	2,806	2,726	2,668	2,624	2,589	2,561	2,538	2,502	2,464	2,425	2,404	2,383	2,361	2,339	2,316	2,293
9	3,360	3,006	2,813	2,693	2,611	2,551	2,505	2,469	2,440	2,416	2,379	2,340	2,298	2,277	2,255	2,232	2,208	2,184	2,159
10	3,285	2,924	2,728	2,605	2,522	2,461	2,414	2,377	2,347	2,323	2,284	2,244	2,201	2,178	2,155	2,132	2,107	2,082	2,055
11	3,225	2,860	2,660	2,536	2,451	2,389	2,342	2,304	2,274	2,248	2,209	2,167	2,123	2,100	2,076	2,052	2,026	2,000	1,972
12	3,177	2,807	2,606	2,480	2,394	2,331	2,283	2,245	2,214	2,188	2,147	2,105	2,060	2,036	2,011	1,986	1,960	1,932	1,904
13	3,136	2,763	2,560	2,434	2,347	2,283	2,234	2,195	2,164	2,138	2,097	2,053	2,007	1,983	1,958	1,931	1,904	1,876	1,846
14	3,102	2,726	2,522	2,395	2,307	2,243	2,193	2,154	2,122	2,095	2,054	2,010	1,962	1,938	1,912	1,885	1,857	1,828	1,797
15	3,073	2,695	2,490	2,361	2,273	2,208	2,158	2,119	2,086	2,059	2,017	1,972	1,924	1,899	1,873	1,845	1,817	1,787	1,755
16	3,048	2,668	2,462	2,333	2,244	2,178	2,128	2,088	2,055	2,028	1,985	1,940	1,891	1,866	1,839	1,811	1,782	1,751	1,718
17	3,026	2,645	2,437	2,308	2,218	2,152	2,102	2,061	2,028	2,001	1,958	1,912	1,862	1,836	1,809	1,781	1,751	1,719	1,686
18	3,007	2,624	2,416	2,286	2,196	2,130	2,079	2,038	2,005	1,977	1,933	1,887	1,837	1,810	1,783	1,754	1,723	1,691	1,657
19	2,990	2,606	2,397	2,266	2,176	2,109	2,058	2,017	1,984	1,956	1,912	1,865	1,814	1,787	1,759	1,730	1,699	1,666	1,631
20	2,975	2,589	2,380	2,249	2,158	2,091	2,040	1,999	1,965	1,937	1,892	1,845	1,794	1,767	1,738	1,708	1,677	1,643	1,607
21	2,961	2,575	2,365	2,233	2,142	2,075	2,023	1,982	1,948	1,920	1,875	1,827	1,776	1,748	1,719	1,689	1,657	1,623	1,586

▼ M2

$N - 1$	1	2	3	4	5	6	7	8	9	10	12	15	20	24	30	40	60	120	1000+
20	2,949	2,561	2,351	2,219	2,128	2,061	2,008	1,967	1,933	1,904	1,859	1,811	1,759	1,731	1,702	1,671	1,639	1,604	1,567
23	2,937	2,549	2,339	2,207	2,115	2,047	1,995	1,953	1,919	1,890	1,845	1,796	1,744	1,716	1,686	1,655	1,622	1,587	1,549
24	2,927	2,538	2,327	2,195	2,103	2,035	1,983	1,941	1,906	1,877	1,832	1,783	1,730	1,702	1,672	1,641	1,607	1,571	1,533
25	2,918	2,528	2,317	2,184	2,092	2,024	1,971	1,929	1,895	1,866	1,820	1,771	1,718	1,689	1,659	1,627	1,593	1,557	1,518
26	2,909	2,519	2,307	2,174	2,082	2,014	1,961	1,919	1,884	1,855	1,809	1,760	1,706	1,677	1,647	1,615	1,581	1,544	1,504
27	2,901	2,511	2,299	2,165	2,073	2,005	1,952	1,909	1,874	1,845	1,799	1,749	1,695	1,666	1,636	1,603	1,569	1,531	1,491
28	2,894	2,503	2,291	2,157	2,064	1,996	1,943	1,900	1,865	1,836	1,790	1,740	1,685	1,656	1,625	1,593	1,558	1,520	1,478
29	2,887	2,495	2,283	2,149	2,057	1,988	1,935	1,892	1,857	1,827	1,781	1,731	1,676	1,647	1,616	1,583	1,547	1,509	1,467
30	2,881	2,489	2,276	2,142	2,049	1,980	1,927	1,884	1,849	1,819	1,773	1,722	1,667	1,638	1,606	1,573	1,538	1,499	1,456
40	2,835	2,440	2,226	2,091	1,997	1,927	1,873	1,829	1,793	1,763	1,715	1,662	1,605	1,574	1,541	1,506	1,467	1,425	1,377
60	2,791	2,393	2,177	2,041	1,946	1,875	1,819	1,775	1,738	1,707	1,657	1,603	1,543	1,511	1,476	1,437	1,395	1,348	1,291
120	2,748	2,347	2,130	1,992	1,896	1,824	1,767	1,722	1,684	1,652	1,601	1,545	1,482	1,447	1,409	1,368	1,320	1,265	1,193
1000+	2,706	2,303	2,084	1,945	1,847	1,774	1,717	1,670	1,632	1,599	1,546	1,487	1,421	1,383	1,342	1,295	1,240	1,169	1,000

Table 7-10

Critical F values, F_{crit95} , versus $N - 1$ and $N_{ref} - 1$ at 95 per cent confidence

$N - 1$	1	2	3	4	5	6	7	8	9	10	12	15	20	24	30	40	60	120	1000+
$N_{ref} - 1$																			
1	161,4	199,5	215,7	224,5	230,1	233,9	236,7	238,8	240,5	241,8	243,9	245,9	248,0	249,0	250,1	251,1	252,2	253,2	254,3
2	18,51	19,00	19,16	19,24	19,29	19,33	19,35	19,37	19,38	19,39	19,41	19,42	19,44	19,45	19,46	19,47	19,47	19,48	19,49
3	10,12	9,552	9,277	9,117	9,014	8,941	8,887	8,845	8,812	8,786	8,745	8,703	8,660	8,639	8,617	8,594	8,572	8,549	8,526
4	7,709	6,944	6,591	6,388	6,256	6,163	6,094	6,041	5,999	5,964	5,912	5,858	5,803	5,774	5,746	5,717	5,688	5,658	5,628
5	6,608	5,786	5,410	5,192	5,050	4,950	4,876	4,818	4,773	4,735	4,678	4,619	4,558	4,527	4,496	4,464	4,431	4,399	4,365
6	5,987	5,143	4,757	4,534	4,387	4,284	4,207	4,147	4,099	4,060	4,000	3,938	3,874	3,842	3,808	3,774	3,740	3,705	3,669

▼ M2

$N - 1$	1	2	3	4	5	6	7	8	9	10	12	15	20	24	30	40	60	120	1000+
7	5,591	4,737	4,347	4,120	3,972	3,866	3,787	3,726	3,677	3,637	3,575	3,511	3,445	3,411	3,376	3,340	3,304	3,267	3,230
8	5,318	4,459	4,066	3,838	3,688	3,581	3,501	3,438	3,388	3,347	3,284	3,218	3,150	3,115	3,079	3,043	3,005	2,967	2,928
9	5,117	4,257	3,863	3,633	3,482	3,374	3,293	3,230	3,179	3,137	3,073	3,006	2,937	2,901	2,864	2,826	2,787	2,748	2,707
10	4,965	4,103	3,708	3,478	3,326	3,217	3,136	3,072	3,020	2,978	2,913	2,845	2,774	2,737	2,700	2,661	2,621	2,580	2,538
11	4,844	3,982	3,587	3,357	3,204	3,095	3,012	2,948	2,896	2,854	2,788	2,719	2,646	2,609	2,571	2,531	2,490	2,448	2,405
12	4,747	3,885	3,490	3,259	3,106	2,996	2,913	2,849	2,796	2,753	2,687	2,617	2,544	2,506	2,466	2,426	2,384	2,341	2,296
13	4,667	3,806	3,411	3,179	3,025	2,915	2,832	2,767	2,714	2,671	2,604	2,533	2,459	2,420	2,380	2,339	2,297	2,252	2,206
14	4,600	3,739	3,344	3,112	2,958	2,848	2,764	2,699	2,646	2,602	2,534	2,463	2,388	2,349	2,308	2,266	2,223	2,178	2,131
15	4,543	3,682	3,287	3,056	2,901	2,791	2,707	2,641	2,588	2,544	2,475	2,403	2,328	2,288	2,247	2,204	2,160	2,114	2,066
16	4,494	3,634	3,239	3,007	2,852	2,741	2,657	2,591	2,538	2,494	2,425	2,352	2,276	2,235	2,194	2,151	2,106	2,059	2,010
17	4,451	3,592	3,197	2,965	2,810	2,699	2,614	2,548	2,494	2,450	2,381	2,308	2,230	2,190	2,148	2,104	2,058	2,011	1,960
18	4,414	3,555	3,160	2,928	2,773	2,661	2,577	2,510	2,456	2,412	2,342	2,269	2,191	2,150	2,107	2,063	2,017	1,968	1,917
19	4,381	3,522	3,127	2,895	2,740	2,628	2,544	2,477	2,423	2,378	2,308	2,234	2,156	2,114	2,071	2,026	1,980	1,930	1,878
20	4,351	3,493	3,098	2,866	2,711	2,599	2,514	2,447	2,393	2,348	2,278	2,203	2,124	2,083	2,039	1,994	1,946	1,896	1,843
21	4,325	3,467	3,073	2,840	2,685	2,573	2,488	2,421	2,366	2,321	2,250	2,176	2,096	2,054	2,010	1,965	1,917	1,866	1,812
22	4,301	3,443	3,049	2,817	2,661	2,549	2,464	2,397	2,342	2,297	2,226	2,151	2,071	2,028	1,984	1,938	1,889	1,838	1,783
23	4,279	3,422	3,028	2,796	2,640	2,528	2,442	2,375	2,320	2,275	2,204	2,128	2,048	2,005	1,961	1,914	1,865	1,813	1,757
24	4,260	3,403	3,009	2,776	2,621	2,508	2,423	2,355	2,300	2,255	2,183	2,108	2,027	1,984	1,939	1,892	1,842	1,790	1,733
25	4,242	3,385	2,991	2,759	2,603	2,490	2,405	2,337	2,282	2,237	2,165	2,089	2,008	1,964	1,919	1,872	1,822	1,768	1,711
26	4,225	3,369	2,975	2,743	2,587	2,474	2,388	2,321	2,266	2,220	2,148	2,072	1,990	1,946	1,901	1,853	1,803	1,749	1,691
27	4,210	3,354	2,960	2,728	2,572	2,459	2,373	2,305	2,250	2,204	2,132	2,056	1,974	1,930	1,884	1,836	1,785	1,731	1,672
28	4,196	3,340	2,947	2,714	2,558	2,445	2,359	2,291	2,236	2,190	2,118	2,041	1,959	1,915	1,869	1,820	1,769	1,714	1,654
29	4,183	3,328	2,934	2,701	2,545	2,432	2,346	2,278	2,223	2,177	2,105	2,028	1,945	1,901	1,854	1,806	1,754	1,698	1,638

▼ M2

$N - 1$	1	2	3	4	5	6	7	8	9	10	12	15	20	24	30	40	60	120	1000+
30	4,171	3,316	2,922	2,690	2,534	2,421	2,334	2,266	2,211	2,165	2,092	2,015	1,932	1,887	1,841	1,792	1,740	1,684	1,622
40	4,085	3,232	2,839	2,606	2,450	2,336	2,249	2,180	2,124	2,077	2,004	1,925	1,839	1,793	1,744	1,693	1,637	1,577	1,509
60	4,001	3,150	2,758	2,525	2,368	2,254	2,167	2,097	2,040	1,993	1,917	1,836	1,748	1,700	1,649	1,594	1,534	1,467	1,389
120	3,920	3,072	2,680	2,447	2,290	2,175	2,087	2,016	1,959	1,911	1,834	1,751	1,659	1,608	1,554	1,495	1,429	1,352	1,254
1000+	3,842	2,996	2,605	2,372	2,214	2,099	2,010	1,938	1,880	1,831	1,752	1,666	1,571	1,517	1,459	1,394	1,318	1,221	1,000

▼ B**6. Slope**

The least-squares regression slope, a_{1y} , shall be calculated by means of equation (7-162):

$$a_{1y} = \frac{\sum_{i=1}^N (y_i - \bar{y}) \cdot (y_{\text{ref}i} - \bar{y}_{\text{ref}})}{\sum_{i=1}^N (y_{\text{ref}i} - \bar{y}_{\text{ref}})^2} \quad (7-162)$$

7. Intercept

The least-squares regression intercept, a_{0y} , shall be calculated by means of equation (7-163):

$$a_{0y} = \bar{y} - (a_{1y} \cdot \bar{y}_{\text{ref}}) \quad (7-163)$$

8. Standard estimate of error

The standard estimate of error, SEE , shall be calculated by means of equation (7-164):

$$SEE_y = \sqrt{\frac{\sum_{i=1}^N [y_i - a_{0y} - (a_{1y} \cdot y_{\text{ref}i})]^2}{N - 2}} \quad (7-164)$$

9. Coefficient of determination

The coefficient of determination, r^2 , shall be calculated by means of equation (7-165):

$$r_y^2 = 1 - \frac{\sum_{i=1}^N [y_i - a_{0y} - (a_{1y} \cdot y_{\text{ref}i})]^2}{\sum_{i=1}^N [y_i - \bar{y}]^2} \quad (7-165)$$

▼ B*Appendix 4***1980 INTERNATIONAL GRAVITY FORMULA**

The acceleration of Earth's gravity, a_g , varies depending on the location and a_g shall be calculated for a respective latitude, by means of equation (7-166):

$$a_g = 9,7803267715 [1 + 5,2790414 \times 10^{-3} \sin^2 \theta + 2,32718 \times 10^{-5} \sin^4 \theta + 1,262 \times 10^{-7} \sin^6 \theta + 7 \times 10^{-10} \sin^8 \theta] \quad (7-166)$$

Where:

θ = Degrees north or south latitude

▼ B*Appendix 5***Particle number calculation****1. Determination of particle numbers****1.1. Time alignment**

For partial flow dilution systems residence time in the particle number sampling and measurement system shall be accounted for by time aligning the particle number signal with the test cycle and the exhaust gas mass flow rate according to the procedure in point 8.2.1.2 of Annex VI. The transformation time of the particle number sampling and measurement system shall be determined in accordance with point 2.1.3.7 of Appendix 1 of Annex VI.

1.2. Determination of particle numbers for transient (NRTC and LSI-NRTC) test cycles and RMC with a partial flow dilution system

Where particle numbers are sampled using a partial flow dilution system according to the specifications set out in point 9.2.3 of Annex VI, the number of particles emitted over the test cycle shall be calculated by means of equation (7-167):

$$N = \frac{m_{edf}}{1,293} \cdot k \cdot \bar{c}_s \cdot \bar{f}_r \cdot 10^6 \quad (7-167)$$

Where:

N is the number of particles emitted over the test cycle, [#/test],

m_{edf} is the mass of equivalent diluted exhaust gas over the cycle, determined by means of equation (7-45) (point 2.3.1.1.2), [kg/test],

k is the calibration factor to correct the particle number counter measurements to the level of the reference instrument where this is not applied internally within the particle number counter. Where the calibration factor is applied internally within the particle number counter, a value of 1 shall be used for k in equation (7-167),

\bar{c}_s is the average concentration of particles from the diluted exhaust gas corrected to standard conditions (273,2 K and 101,33 kPa), particles per cubic centimetre,

\bar{f}_r is the mean particle concentration reduction factor of the volatile particle remover specific to the dilution settings used for the test.

with

$$\bar{c}_s = \frac{\sum_{i=1}^{i=n} c_{s,i}}{n} \quad (7-168)$$

Where:

$c_{s,i}$ is a discrete measurement of particle concentration in the diluted exhaust gas from the particle counter, corrected for coincidence and to standard conditions (273,2 K and 101,33 kPa), particles per cubic centimetre,

n is the number of particle concentration measurements taken over the duration of the test.

▼ B

1.3. Determination of particle numbers for transient (NRTC and LSI-NRTC) test cycles and RMC with a full flow dilution system

Where particle numbers are sampled using a full flow dilution system according to the specifications set out in point 9.2.2 of Annex VI, the number of particles emitted over the test cycle shall be calculated by means of equation (7-169):

$$N = \frac{m_{edf}}{1,293} \cdot k \cdot \bar{c}_s \cdot \bar{f}_r \cdot 10^6 \quad (7-169)$$

Where:

N is the number of particles emitted over the test cycle, [#/test],

m_{ed} is the total diluted exhaust gas flow over the cycle calculated according to any one of the methods described in points 2.2.4.1 to 2.2.4.3, of Annex VII, kg/test,

k is the calibration factor to correct the particle number counter measurements to the level of the reference instrument where this is not applied internally within the particle number counter. Where the calibration factor is applied internally within the particle number counter, a value of 1 shall be used for k in equation (7-169),

\bar{c}_s is the average corrected concentration of particles from the diluted exhaust gas corrected to standard conditions (273,2 K and 101,33 kPa), particles per cubic centimetre,

\bar{f}_r is the mean particle concentration reduction factor of the volatile particle remover specific to the dilution settings used for the test.

with

$$\bar{c} = \frac{\sum_{i=1}^{i=n} c_{s,i}}{n} \quad (7-170)$$

Where:

$c_{s,i}$ is a discrete measurement of particle concentration in the diluted gas exhaust from the particle counter, corrected for coincidence and to standard conditions (273,2 K and 101,33 kPa), particles per cubic centimetre,

n is the number of particle concentration measurements taken over the duration of the test

1.4. Determination of particle numbers for discrete-mode NRSC with a partial flow dilution system

Where particle numbers are sampled using a partial flow dilution system according to the specifications set out in point 9.2.3 of Annex VI, the rate of emission of particles during each individual discrete-mode shall be calculated by means of equation (7-171) using the average values for the mode:

$$\dot{N} = \frac{q_{medf}}{1,293} \times k \times \bar{c}_s \times \bar{f}_r \times 10^6 \times 3\,600 \quad (7-171)$$

Where:

\dot{N} is the rate of emission of particles during the individual discrete-mode, [#h],

q_{medf} is the equivalent diluted exhaust mass flow rate on a wet basis during the individual discrete-mode, determined in accordance with equation (7-51) (point 2.3.2.1), [kg/s],

▼ B

k is the calibration factor to correct the particle number counter measurements to the level of the reference instrument where this is not applied internally within the particle number counter. Where the calibration factor is applied internally within the particle number counter, a value of 1 shall be used for k in the equation (1-171),

\bar{c}_s is the average concentration of particles from the diluted exhaust gas during the individual discrete-mode corrected to standard conditions (273,2 K and 101,33 kPa), particles per cubic centimetre,

\bar{f}_r is the mean particle concentration reduction factor of the volatile particle remover specific to the dilution settings used for the test.

with

$$\bar{c}_s = \frac{\sum_{i=1}^{i=n} c_{s,i}}{n} \quad (7-172)$$

Where:

$c_{s,i}$ is a discrete measurement of particle concentration in the diluted gas exhaust from the particle counter, corrected for coincidence and to standard conditions (273,2 K and 101,33 kPa), particles per cubic centimetre,

n is the number of particle concentration measurements taken during the individual discrete-mode sampling period

1.5. Determination of particle numbers for discrete-mode cycles with a full flow dilution system

Where particle numbers are sampled using a full flow dilution system according to the specifications set out in point 9.2.2 of Annex VI, the rate of emission of particles during each individual discrete-mode shall be calculated by means of equation (7-173) using the average values for the mode:

$$\dot{N} = \frac{q_{mdew}}{1,293} \times k \times \bar{c}_s \times \bar{f}_r \times 10^6 \times 3\,600 \quad (7-173)$$

Where:

\dot{N} is the rate of emission of particles during the individual discrete-mode, [#h],

q_{mdew} is the total diluted exhaust mass flow rate on a wet basis during the individual discrete-mode, [kg/s],

k is the calibration factor to correct the particle number counter measurements to the level of the reference instrument where this is not applied internally within the particle number counter. Where the calibration factor is applied internally within the particle number counter, a value of 1 shall be used for k in equation (7-173),

\bar{c}_s is the average concentration of particles from the diluted exhaust gas during the individual discrete-mode corrected to standard conditions (273,2 K and 101,33 kPa), particles per cubic centimetre,

\bar{f}_r is the mean particle concentration reduction factor of the volatile particle remover specific to the dilution settings used for the test.

▼ B

with

$$\bar{c}_s = \frac{\sum_{i=1}^{i=n} c_{s,i}}{n} \quad (7-174)$$

Where:

$c_{s,i}$ is a discrete measurement of particle concentration in the diluted gas exhaust from the particle counter, corrected for coincidence and to standard conditions (273,2 K and 101,33 kPa), particles per cubic centimetre,

n is the number of particle concentration measurements taken during the individual discrete-mode sampling period.

2. Test result

2.1. Calculation of the specific emissions for transient (NRTC and LSI-NRTC) test cycles and RMC

For each applicable individual RMC, hot-start NRTC and cold-start NRTC the specific emissions in number of particles/kWh shall be calculated by means of equation (7-175):

$$e = \frac{N}{W_{act}} \quad (7-175)$$

Where:

N is the number of particles emitted over the applicable RMC, hot-start run of the NRTC or cold-start NRTC,

W_{act} is the actual cycle work in accordance with point 7.8.3.4 of Annex VI, [kWh].

For an RMC, in case of an engine with infrequent (periodic) exhaust after-treatment system regeneration (see point 6.6.2 of Annex VI), the specific emissions shall be corrected with either the applicable multiplicative adjustment factor or with the applicable adjustment additive factor. In the case that infrequent regeneration did not take place during the test the upward factor shall be applied ($k_{ru,m}$ or $k_{ru,a}$). In the case that infrequent regeneration took place during the test the downward factor shall be applied ($k_{rd,m}$ or $k_{rd,a}$).

For an RMC the final result shall also be adjusted with the applicable multiplicative or additive deterioration factor established according to the requirements of Annex III.

2.1.1. Weighted average NRTC test result

For the NRTC, the final test result shall be a weighted average from cold-start run and hot-start run (including infrequent regeneration where relevant) shall be calculated by means of equation (7-176) or (7-177):

(a) In the case of multiplicative regeneration adjustment, or engines without infrequently regenerating exhaust after-treatment system

$$e = k_r \left(\frac{(0,1 \times N_{cold}) + (0,9 \times N_{hot})}{(0,1 \times W_{act,cold}) + (0,9 \times W_{act,hot})} \right) \quad (7-176)$$

In the case of additive regeneration adjustment

$$e = k_r + \left(\frac{(0,1 \times N_{cold}) + (0,9 \times N_{hot})}{(0,1 \times W_{act,cold}) + (0,9 \times W_{act,hot})} \right) \quad (7-177)$$

▼ B

Where:

N_{cold} is the total number of particles emitted over the NRTC cold-start run of the NRTC,

N_{hot} is the total number of particles emitted over the NRTC hot-start run of the NRTC,

$W_{act,cold}$ is the actual cycle work over the cold-start NRTC in accordance with point 7.8.3.4 of Annex VI, [kWh],

$W_{act, hot}$ is the actual cycle work over the hot-start NRTC in accordance with point 7.8.3.4 of Annex VI, [kWh],

k_r is the regeneration adjustment, according to point 6.6.2 of Annex VI, or in the case of engines without infrequently regenerating exhaust after-treatment system $k_r = 1$

In the case that infrequent regeneration did not take place during the test the upward factor shall be applied ($k_{ru,m}$ or $k_{ru,a}$). In the case that infrequent regeneration took place during the test the downward factor shall be applied ($k_{rd,m}$ or $k_{rd,a}$).

The result, where applicable inclusive of infrequent regeneration adjustment factor, shall also be adjusted by the applicable multiplicative or additive deterioration factor established according to the requirements of Annex III.

2.2. Calculation of the specific emissions for discrete-mode NRSC tests

The specific emissions e [#kWh] shall be calculated by means of equation (7-178):

$$e = \frac{\sum_{i=1}^{N_{mode}} (\dot{N}_i \cdot WF_i)}{\sum_{i=1}^{N_{mode}} (P_i \cdot WF_i)} \quad (7-178)$$

Where:

▼ M2

P_i engine power for the mode i [kW] calculated by adding to the measured power P_{meas} [kW] the power required to drive auxiliaries P_{AUX} [kW] determined in accordance with equation (6-8) of Annex VI ($P_i = P_{meas} + P_{AUX}$).

▼ B

WF_i is the weighting factor for the mode i [-]

\dot{N}_i is the mean emission number flow rate for the mode i [#h] from equation (7-171) or (7-173) depending upon the dilution method

In case of an engine with infrequent (periodic) exhaust after-treatment system regeneration (see point 6.6.2 of Annex VI), the specific emissions shall be corrected with either the applicable multiplicative adjustment factor or with the applicable adjustment additive factor. In the case that infrequent regeneration did not take place during the test the upward factor shall be applied ($k_{ru,m}$ or $k_{ru,a}$). In the case that infrequent regeneration took place during the test the downward factor shall be applied ($k_{rd,m}$ or $k_{rd,a}$). Where the adjustment factors have been determined for each mode they shall be applied to each mode during the calculation of the weighted emission result at equation (7-178).

The result, where applicable inclusive of infrequent regeneration adjustment factor, shall also be adjusted by the applicable multiplicative or additive deterioration factor established according to the requirements of Annex III.

▼ B

2.3. Rounding of final results

► **M2** The final NRSC and weighted average NRTC test results shall be rounded in one step to three significant figures in accordance with ASTM E 29–06B. ◀ No rounding of intermediate values leading to the final brake specific emission result is permissible.

2.4. Determination of particle number background

2.4.1. At the engine manufacturer's request, dilution tunnel background particle number concentrations may be sampled, prior to or after the test, from a point downstream of the particle and hydrocarbon filters into the particle number measurement system, to determine the tunnel background particle concentrations.

2.4.2. Subtraction of particle number tunnel background concentrations shall not be allowed for type-approval, but may be used at the manufacturer's request, with the prior approval of the approval authority, for conformity of production testing, if it can be demonstrated that tunnel background contribution is significant, which can then be subtracted from the values measured in the diluted exhaust gas.

▼ B*Appendix 6***Ammonia emission calculation****1. Calculation of the mean concentration for transient (NRTC and LSI-NRTC) test cycles and RMC**

The mean NH₃ concentration in the exhaust gas over the test cycle c_{NH_3} [ppm] shall be determined by integrating the instantaneous values over the cycle. Equation (7-179) shall be applied:

$$c_{\text{NH}_3} = \frac{1}{n} \sum_{i=1}^{i=n} c_{\text{NH}_3,i} \quad (7-179)$$

Where:

$c_{\text{NH}_3,i}$ is the instantaneous NH₃ concentration in the exhaust gas [ppm]

n is the number of measurements

For the NRTC, the final test result shall be calculated by means of equation (7-180):

▼ M2

$$c_{\text{NH}_3} = (0,1 \times c_{\text{NH}_3,\text{cold}}) + (0,9 \times c_{\text{NH}_3,\text{hot}}) \quad (7-180)$$

▼ B

Where:

$c_{\text{NH}_3,\text{cold}}$ is the mean NH₃ concentration of the cold-start NRTC [ppm]

$c_{\text{NH}_3,\text{hot}}$ is the mean NH₃ concentration of the hot-start NRTC [ppm]

2. Calculation of the mean concentration for discrete-mode NRSC

The mean NH₃ concentration in the exhaust gas over the test cycle c_{NH_3} [ppm] shall be determined by measuring the mean concentration for each mode and weighting the result in accordance with the weighting factors applicable to the test cycle. Equation (7-181) shall be applied:

$$c_{\text{NH}_3} = \sum_{i=1}^{N_{\text{mode}}} \bar{c}_{\text{NH}_3,i} \cdot WF_i \quad (7-181)$$

Where:

$\bar{c}_{\text{NH}_3,i}$ is the mean NH₃ concentration in the exhaust gas for mode i [ppm]

N_{mode} is the number of modes in the test cycle

WF_i is the weighting factor for the mode i [-]



ANNEX VIII

Performance requirements and test procedures for dual-fuel engines

1. Scope

This Annex shall apply for dual-fuel engines as defined in Article 3(18) of Regulation (EU) 2016/1628 when they are being operated simultaneously on both a liquid and a gaseous fuel (dual-fuel mode).

This Annex shall not apply for testing engines, including dual-fuel engines, when they are being operated solely on liquid or solely on gaseous fuels (i.e. when the GER is either 1 or 0 according to the type of fuel). In this case the requirements are the same as for any single-fuel engine.

Type approval of engines operated simultaneously on a combination of more than one liquid fuel and a gaseous fuel or a liquid fuel and more than one gaseous fuel shall follow the procedure for new technologies or new concepts given in Article 33 of Regulation (EU) 2016/1628.

2. Definitions and abbreviations

For the purposes of this Annex the following definitions shall apply:

- 2.1. ‘GER (Gas Energy Ratio)’ has the meaning defined in Article 3(20) of Regulation (EU) 2016/1628 based on the lower heating value;
- 2.2. ‘GER_{cycle}’ means the average GER when operating the engine on the applicable engine test cycle;
- 2.3. ‘Dual-fuel Type 1A engine’ means either:
 - (a) a dual-fuel engine of a sub-category of NRE $19 \leq \text{kW} \leq 560$, that operates over the hot-start NRTC test-cycle with an average gas energy ratio that is not lower than 90 % ($\text{GER}_{\text{NRTC, hot}} \geq 0,9$) and that does not idle using exclusively liquid fuel, and that has no liquid-fuel mode, or;
 - (b) a dual-fuel engine of any (sub-) category other than a sub-category of NRE $19 \leq \text{kW} \leq 560$, that operates over the NRSC with an average gas energy ratio that is not lower than 90 % ($\text{GER}_{\text{NRSC}} \geq 0,9$) and that does not idle using exclusively liquid fuel, and that has no liquid-fuel mode;
- 2.4. ‘Dual-Fuel Type 1B engine’ means either:
 - (a) a dual-fuel engine of a sub-category of NRE $19 \leq \text{kW} \leq 560$, that operates over the hot-start NRTC test-cycle with an average gas energy ratio that is not lower than 90 % ($\text{GER}_{\text{NRTC, hot}} \geq 0,9$) and that does not idle using exclusively liquid fuel in dual-fuel mode, and that has a liquid-fuel mode, or;
 - (b) a dual-fuel engine of any (sub-) category other than a sub-category of NRE $19 \leq \text{kW} \leq 560$, that operates over the NRSC with an average gas energy ratio that is not lower than 90 % ($\text{GER}_{\text{NRSC}} \geq 0,9$) and that does not idle using exclusively liquid fuel in dual-fuel mode, and that has a liquid-fuel mode;

▼B

- 2.5. 'Dual-Fuel Type 2A engine' means either:
- (a) a dual-fuel engine of a sub-category of NRE $19 \leq kW \leq 560$, that operates over the hot-start NRTC test-cycle with an average gas energy ratio between 10 % and 90 % ($0,1 < GER_{NRTC, hot} < 0,9$) and that has no liquid-fuel mode or that operates over the hot-start NRTC test-cycle with an average gas energy ratio that is not lower than 90 % ($GER_{NRTC, hot} \geq 0,9$), but that idles using exclusively liquid fuel, and that has no liquid-fuel mode, or;
 - (b) a dual-fuel engine of any (sub-) category other than a sub-category of NRE $19 \leq kW \leq 560$, that operates over the NRSC with an average gas energy ratio between 10 % and 90 % ($0,1 < GER_{NRSC} < 0,9$), and that has no liquid-fuel mode or that operates over the NRSC with an average gas energy ratio that is not lower than 90 % ($GER_{NRSC} \geq 0,9$), but that idles using exclusively liquid fuel, and that has no liquid-fuel mode;
- 2.6. 'Dual-Fuel Type 2B engine' means either:
- (a) a dual-fuel engine of a sub-category of NRE $19 \leq kW \leq 560$, that operates over the hot-start NRTC test-cycle with an average gas energy ratio between 10 % and 90 % ($0,1 < GER_{NRTC, hot} < 0,9$) and that has a liquid-fuel mode or that operates over the hot-start NRTC test-cycle with an average gas energy ratio that is not lower than 90 % ($GER_{NRTC, hot} \geq 0,9$), and that has a liquid-fuel mode but that can idle using exclusively liquid fuel in dual-fuel mode, or;
 - (b) a dual-fuel engine of any (sub-) category other than a sub-category of NRE $19 \leq kW \leq 560$, that operates over the NRSC with an average gas energy ratio between 10 % and 90 % ($0,1 < GER_{NRSC} < 0,9$), and that has no liquid-fuel mode or that operates over the NRSC with an average gas energy ratio that is not lower than 90 % ($GER_{NRSC} \geq 0,9$), and that has a liquid-fuel mode but that can idle using exclusively liquid fuel in dual-fuel mode;
- 2.7. 'Dual-Fuel Type 3B engine' means either:
- (a) a dual-fuel engine of a sub-category of NRE $19 \leq kW \leq 560$, that operates over the hot-start NRTC test-cycle with an average gas energy ratio that does not exceed 10 % ($GER_{NRTC, hot} \leq 0,1$) and that has a liquid-fuel mode, or;
 - (b) a dual-fuel engine of any (sub-) category other than a sub-category of NRE $19 \leq kW \leq 560$, that operates over the NRSC with an average gas energy ratio that does not exceed 10 % ($GER_{NRSC} \leq 0,1$) and that has a liquid-fuel mode;

3. Dual-fuel specific additional approval requirements

3.1. Engines with operator-adjustable control of GER_{cycle} .

In the case for a given engine type the value of GER_{cycle} can be reduced from the maximum by an operator-adjustable control, the minimum GER_{cycle} shall not be limited but the engine shall be capable of meeting the emission limit values at any value of GER_{cycle} permitted by the manufacturer.

▼B**4. General requirements****4.1. Operating modes of dual-fuel engines****4.1.1. Conditions for a dual-fuel engine to operate in liquid mode**

A dual-fuel engine may only operate in liquid-fuel mode if, when operating in liquid-fuel mode, it has been certified according to all the requirements of this Regulation concerning operation solely on the specified liquid fuel.

When a dual-fuel engine is developed from an already certified liquid-fuel engine, then a new EU type approval certificate is required in the liquid-fuel mode.

4.1.2. Conditions for a dual-fuel engine to idle using liquid fuel exclusively

4.1.2.1. Dual-fuel Type 1A engines shall not idle using liquid fuel exclusively except under the conditions defined in point 4.1.3 for warm-up and start.

4.1.2.2. Dual-fuel Type 1B engines shall not idle using liquid fuel exclusively in dual-fuel mode.

4.1.2.3. Dual-fuel Types 2A, 2B and 3B engines may idle using liquid fuel exclusively.

4.1.3. Conditions for a dual-fuel engine to warm-up or start using liquid fuel solely

4.1.3.1. A Type 1B, Type 2B, or Type 3B dual-fuel engine may warm-up or start using liquid fuel solely. In the case that the emission control strategy during warm-up or start-up in dual-fuel mode is the same as the corresponding emission control strategy in liquid-fuel mode the engine may operate in dual-fuel mode during warm-up or start-up. If this condition is not met the engine shall only warm-up or start-up using liquid fuel solely when in liquid-fuel mode.

4.1.3.2. A Type 1A or Type 2A dual-fuel engine may warm-up or start-up using liquid fuel solely. However, in that case, the strategy shall be declared as an AECS and the following additional requirements shall be met:

4.1.3.2.1. The strategy shall cease to be active when the coolant temperature has reached a temperature of 343 K (70 °C), or within 15 minutes after it has been activated, whichever occurs first; and

4.1.3.2.2. The service mode shall be activated while the strategy is active.

4.2. Service mode**4.2.1. Conditions for dual-fuel engines to operate in service mode**

When an engine is operating in service mode it is subject to an operability restriction and is temporarily exempted from complying with the requirements related to exhaust emissions and NO_x control described in this Regulation.

▼B

4.2.2. Operability restriction in service mode

4.2.2.1. Requirement for engine categories other than IWP, IWA, RLL and RLR

The operability restriction applicable to non-road mobile machinery fitted with a dual-fuel engine of engine categories other than IWP, IWA, RLL and RLR operated in service mode is the one activated by the 'severe inducement system' specified in point 5.4 of Appendix 1 of Annex IV.

In order to account for safety concerns and to allow for self-healing diagnostics, use of an inducement override function for releasing full engine power is permitted according to point 5.5 of Appendix 1 of Annex IV.

The operability restriction shall not otherwise be deactivated by either the activation or deactivation of the warning and inducement systems specified in Annex IV.

The activation and the deactivation of the service mode shall not activate or deactivate the warning and inducement systems specified in Annex IV.

4.2.2.2. Requirement for engine categories IWP, IWA, RLL and RLR

For engines of category IWP, IWA, RLL and RLR, in order to account for safety concerns operation in service mode shall be permitted without limitation on engine torque or speed. In this case whenever an operability restriction would have been active according to point 4.2.2.3 the on-board computer log shall record in non-volatile computer memory all incidents of engine operation where the service mode is active in a manner to ensure that the information cannot be intentionally deleted.

It shall be possible for national inspection authorities to read these records with a scan tool. ►**M2** A description of the connection for, and method to read, those records shall be included in the information folder as set out in Part A of Annex I of Implementing Regulation (EU) 2017/656. ◀

4.2.2.3. Activation of the operability restriction

The operability restriction shall be automatically activated when the service mode is activated.

In the case where the service mode is activated according to point 4.2.3 because of a malfunction of the gas supply system, the operability restriction shall become active within 30 minutes operating time after the service mode is activated.

In the case where the service mode is activated because of an empty gaseous fuel tank, the operability restriction shall become active as soon as the service mode is activated.

4.2.2.4. Deactivation of the operability restriction

The operability restriction system shall be deactivated when the engine no longer operates in service mode.

4.2.3. Unavailability of gaseous fuel when operating in a dual-fuel mode

In order to permit the non-road mobile machinery to move to a position of safety, upon detection of an empty gaseous fuel tank, or of a malfunctioning gas supply system:

- (a) Dual-fuel engines of Types 1A and 2A shall activate the service mode;

▼B

(b) Dual-fuel engines of Types 1B, 2B and 3B shall operate in liquid mode.

4.2.3.1. Unavailability of gaseous fuel — empty gaseous fuel tank

In the case of an empty gaseous fuel tank, the service mode or, as appropriate according to point 4.2.3, the liquid fuel mode shall be activated as soon as the engine system has detected that the tank is empty.

When the gas availability in the tank again reaches the level that justified the activation of the empty tank warning system specified in point 4.3.2, the service mode may be deactivated, or, when appropriate, the dual-fuel mode may be reactivated.

4.2.3.2. Unavailability of gaseous fuel — malfunctioning gas supply

In the case of a malfunctioning gas supply system that causes the unavailability of gaseous fuel, the service mode or, as appropriate according to point 4.2.3, the liquid fuel mode shall be activated when gaseous fuel supply is not available.

As soon as the gaseous fuel supply becomes available the service mode may be deactivated, or, when appropriate, the dual-fuel mode may be reactivated.

4.3. Dual-fuel indicators

4.3.1. Dual-fuel operating mode indicator

The non-road mobile machinery shall provide to the operator a visual indication of the mode under which the engine operates (dual-fuel mode, liquid mode, or service mode).

The characteristics and the location of this indicator shall be left to the discretion of the OEM and may be part of an already existing visual indication system.

This indicator may be completed by a message display. The system used for displaying the messages referred to in this point may be the same as the ones used for NO_x control diagnostics, or other maintenance purposes.

The visual element of the dual-fuel operating mode indicator shall not be the same as the one used for the purpose of NO_x control diagnostics, or for other engine maintenance purposes.

Safety alerts always have display priority over the operating mode indication.

4.3.1.1. The dual-fuel mode indicator shall be set to service mode as soon as the service mode is activated (i.e. before it becomes actually active) and the indication shall remain as long as the service mode is active.

4.3.1.2. The dual-fuel mode indicator shall be set for at least one minute on dual-fuel mode or liquid-fuel mode as soon as the engine operating mode is changed from liquid fuel to dual-fuel mode or vice-versa. This indication is also required for at least one minute at key-on, or at the request of the manufacturer at engine cranking. The indication shall also be given upon the operator's request.

▼B

4.3.2. Empty gaseous fuel tank warning system (dual-fuel warning system)

Non-road mobile machinery fitted with a dual-fuel engine shall be equipped with a dual-fuel warning system that alerts the operator that the gaseous fuel tank will soon become empty.

The dual-fuel warning system shall remain active until the tank is refuelled to a level above which the warning system is activated.

The dual-fuel warning system may be temporarily interrupted by other warning signals providing important safety-related messages.

It shall not be possible to turn off the dual-fuel warning system by means of a scan-tool as long as the cause of the warning activation has not been rectified.

4.3.2.1. Characteristics of the dual-fuel warning system

The dual-fuel warning system shall consist of a visual alert system (icon, pictogram, etc.) left to the choice of the manufacturer.

It may include, at the choice of the manufacturer, an audible component. In that case, the cancelling of that component by the operator is permitted.

The visual element of the dual-fuel warning system shall not be the same as the one used for the purpose of NO_x control diagnostics, or for other engine maintenance purposes.

In addition the dual-fuel warning system may display short messages, including messages indicating clearly the remaining distance or time before the activation of the operability restriction.

The system used for displaying the warning or messages referred to in this point may be the same as the one used for displaying the warning or messages related the NO_x control diagnostics, or warning or messages for other maintenance purposes.

A facility to permit the operator to dim the visual alarms provided by the warning system may be provided on non-road mobile machinery for use by the rescue services or on non-road mobile machinery designed and constructed for use by the armed services, civil defense, fire services and forces responsible for maintaining public order.

4.4. Communicated torque

4.4.1. Communicated torque when a dual-fuel engine operates in dual-fuel mode

When a dual-fuel engine operates in dual-fuel mode:

- (a) The reference torque curve retrievable shall be the one obtained when that engine is tested on an engine test bench in the dual-fuel mode;
- (b) The recorded actual torques (indicated torque and friction torque) shall be the result of the dual-fuel combustion and not the one obtained when operating with liquid fuel exclusively.

▼ B

- 4.4.2. Communicated torque when a dual-fuel engine operates in liquid-fuel mode

When a dual-fuel engine operates in liquid-fuel mode, the reference torque curve retrievable shall be the one obtained when the engine is tested on an engine test bench in liquid-fuel mode.

- 4.5. Additional requirements

- 4.5.1. Where used for a dual-fuel engine, adaptive strategies shall, in addition to satisfying the requirements of Annex IV, additionally comply with the following requirements:

- (a) The engine shall always remain within the dual-fuel engine type (that is Type 1A, Type 2B, etc.) that has been declared for EU type-approval; and

▼ M2

- (b) In case of a Type 2 engine, the resulting difference between the highest and the lowest maximum GER_{cycle} within the family shall never exceed the range set out in point 2.4.15 of Annex IX to Implementing Regulation (EU) 2017/656, except as permitted by point 3.1.

▼ B

- 4.6 The type-approval shall be conditional upon providing to the OEM and end-users, ► **M2** ————— ◀ in accordance with Annexes XIV and XV, instructions for installation and operation of the dual-fuel engine including the service mode set out in point 4.2 and the dual-fuel indicator system set out in point 4.3.

5. **Performance requirements**

- 5.1. The performance requirements, including emission limit values, and the requirements for EU type-approval applicable to dual-fuel engines are identical to those of any other engine of the respective engine category as set out in this Regulation and in Regulation (EU) 2016/1628, except as set out in this Annex.

- 5.2 The hydrocarbon (HC) limit for operation in dual-fuel mode shall be determined using the average gas energy ratio (GER) over the specified test cycle as set out in Annex II to Regulation (EU) 2016/1628.

- 5.3 The technical requirements on emission control strategies, including documentation required to demonstrate these strategies, technical provisions to resist tampering and the prohibition of defeat devices are identical to those of any other engine of the respective engine category as set out in Annex IV.

- 5.4 The detailed technical requirements on the area associated with the relevant NRSC, within which there is control of the amount that the emissions shall be permitted to exceed the limit values set out in Annex II to Regulation (EU) 2016/1628 are identical to those of any other engine of the respective engine category as set out in Annex IV.

6. **Demonstration requirements**

- 6.1. The demonstration requirements applicable to dual-fuel engines are identical to those of any other engine of the respective engine category as set out in this Regulation and in Regulation (EU) 2016/1628, except as set out in section 6.

▼ B

- 6.2. Compliance with the applicable limit values shall be demonstrated in dual-fuel mode.
- 6.3. For dual-fuel engine types with a liquid-fuel mode (i.e. types 1B, 2B, 3B) compliance with the applicable limit values shall additionally be demonstrated in liquid-fuel mode.
- 6.4. Additional demonstration requirements in case of a Type 2 engine

▼ M2

- 6.4.1 The manufacturer shall present the approval authority with evidence showing that the GER_{cycle} span of all members of the dual-fuel engine family remains within the range set out in point 2.4.15 of Annex IX to Implementing Regulation (EU) 2017/656, or in the case of engines with an operator-adjustable GER_{cycle} satisfy the requirements of point 6.5 (for example, through algorithms, functional analyses, calculations, simulations, results of previous tests, etc.).

▼ B

- 6.5. Additional demonstration requirements in case of an engine with an operator-adjustable GER_{cycle}
- 6.5.1 Compliance with the applicable limit values shall be demonstrated at the minimum and maximum value of GER_{cycle} permitted by the manufacturer.
- 6.6. Requirements for demonstrating the durability of a dual-fuel engine
- 6.6.1 Provisions of Annex III shall apply.
- 6.7. Demonstration of the dual-fuel indicators, warning and operability restriction
- 6.7.1 As part of the application for EU type-approval under this Regulation, the manufacturer shall demonstrate the operation of dual-fuel indicators and of the warning and operability restriction in accordance with the provisions of Appendix 1.

▼ M2

- 6.8. Documentation of the demonstration
 - A demonstration report shall document the demonstration conducted pursuant to points 6.1 to 6.7.1 The report shall:
 - (a) describe the demonstration performed, including the applicable test cycle;
 - (b) be included in the information folder as set out in Part A of Annex I of Implementing Regulation (EU) 2017/656.

▼ B

- 7. **Requirements to ensure the correct operation of NO_x control measures**
- 7.1. Annex IV (technical requirements on NO_x control measures) shall apply to dual-fuel engines, whether operating in dual-fuel or liquid mode.
- 7.2. Additional NO_x control requirements in case of Type 1B, Type 2B and Type 3B dual-fuel engines
 - 7.2.1. The torque considered to apply to the severe inducement defined in point 5.4 of Appendix 1 of Annex IV shall be the lowest of the torques obtained in liquid-fuel mode and in dual-fuel mode.
 - 7.2.2. A possible influence of the mode of operation on the malfunction detection shall not be used to extend the time until an inducement becomes active.

▼B

- 7.2.3. In the case of malfunctions the detection of which does not depend on the operation mode of the engine, the mechanisms specified in Appendix 1 of Annex IV that are associated with the DTC status shall not depend on the operation mode of the engine (for example, if a DTC reached the potential status in dual-fuel mode, it will get the confirmed and active status the next time the failure is detected, even in liquid-fuel mode).
- 7.2.4. In the case of malfunctions where the detection depends on the operation mode of the engine, DTCs shall not get a previously active status in a different mode than the mode in which they reached the confirmed and active status.
- 7.2.5. A change of the mode of operation (dual-fuel to liquid fuel or vice-versa) shall not stop nor reset the mechanisms implemented to comply with the requirements set out in Annex IV (e.g. counters). However, in the case where one of these mechanisms (for example a diagnostic system) depends on the actual operation mode the counter associated with that mechanism may, at the request of the manufacturer and upon approval of the approval authority:
- (a) Halt and, when applicable, hold their present value when the operation mode changes;
 - (b) Restart and, when applicable, continue counting from the point at which they have been held when the operation mode changes backs to the other operation mode.

*Appendix 1***Dual-fuel engine dual-fuel indicator, warning system, operability restriction —
Demonstration requirements****1. Dual-fuel indicators****1.1. Dual-fuel mode indicator**

The ability of the engine to command the activation of the dual-fuel mode indicator when operating in dual-fuel mode shall be demonstrated at EU type-approval.

1.2. Liquid-fuel mode indicator

In the case of a Type 1B, Type 2B, or Type 3B dual-fuel engine the ability of the engine to command the activation of the liquid-fuel mode indicator when operating in liquid-fuel mode shall be demonstrated at EU type-approval.

1.3. Service mode indicator

The ability of the engine to command the activation of the service mode indicator when operating in service mode shall be demonstrated at EU type-approval.

- 1.3.1. When so-equipped it is sufficient to perform the demonstration related to the service mode indicator by activating a service mode activation switch and to present the approval authority with evidence showing that the activation occurs when the service mode is commanded by the engine system itself (for example, through algorithms, simulations, result of in-house tests, etc. ...).

2. Warning system

The ability of the engine to command the activation of the warning system in the case that the amount of gaseous fuel in the gaseous fuel tank is below the warning level, shall be demonstrated at EU type-approval. For that purpose the actual amount of gaseous fuel may be simulated.

3. Operability restriction

In the case of a Type 1A or Type 2A dual-fuel engine the ability of the engine to command the activation of the operability restriction upon detection of an empty gaseous fuel tank and of a malfunctioning gas supply system shall be demonstrated at EU type-approval. For that purpose the empty gaseous fuel tank and the malfunctioning of the gas supply may be simulated.

- 3.1. It is sufficient to perform the demonstration in a typical use-case selected with the agreement of the approval authority and to present that authority with evidence showing that the operability restriction occurs in the other possible use-cases (for example, through algorithms, simulations, result of in-house tests, etc.).

*Appendix 2***Emission test procedure requirements for dual-fuel engines****1. General**

This point defines the additional requirements and exceptions of this Annex to enable emission testing of dual-fuel engines independent whether these emissions are solely exhaust emissions or also crankcase emissions added to the exhaust emissions according to point 6.10 of Annex VI. In the case that no additional requirement or exception is listed, the requirements of this Regulation shall apply to dual-fuel engines in the same way as they apply to any other approved engine types or engine families under Regulation (EU) 2016/1628.

Emission testing of a dual-fuel engine is complicated by the fact that the fuel used by the engine can vary between pure liquid fuel and a combination of mainly gaseous fuel with only a small amount of liquid fuel as an ignition source. The ratio between the fuels used by a dual-fuel engine can also change dynamically depending of the operating condition of the engine. As a result special precautions and restrictions are necessary to enable emission testing of these engines.

2. Test conditions

Section 6 of Annex VI shall apply.

3. Test procedures

Section 7 of Annex VI shall apply.

4. Measurement procedures

Section 8 of Annex VI shall apply except as set out in this Appendix.

A full-flow dilution measurement procedure for dual-fuel engines is illustrated in Figure 6.6 of Annex VI (CVS system).

This measurement procedure ensures that the variation of the fuel composition during the test will mainly influence the hydrocarbon measurement results. ► **M2** This shall be compensated via one of the methods described in point 7 ◀.

Raw gaseous/partial flow measurement illustrated in Figure 6.7 of Annex VI may be used with some precautions regarding exhaust gas mass flow determination and calculation methods.

5. Measurement equipment

Section 9 of Annex VI shall apply.

6. Particle number emissions measurement

Appendix 1 of Annex VI shall apply.

7. Emission calculation

The emission calculation shall be performed according to Annex VII except as set out in this section. The additional requirements set out in point 7.1 shall apply for mass-based calculations and the additional requirements set out in point 7.2 shall apply for molar-based calculations.

▼ B

The emission calculation requires knowledge of the composition of the fuels being used. When a gaseous fuel is supplied with a certificate confirming the properties of the fuel (e.g. gas from bottles) it is acceptable to use the composition specified by the supplier. Where the composition is not available (e.g. pipeline fuel) the fuel composition shall be analysed at least prior to and after the engine emission test is conducted. More frequent analysis shall be permitted and the results used in the calculation.

Where the gas energy ratio (GER) is used it shall be consistent with the definition in Article 3(2) of Regulation (EU) 2016/1628 and the specific provisions on total hydrocarbon (HC) limits for fully and partially gaseous-fuelled engines in Annex II of that Regulation. The average value of GER over the cycle shall be calculated by one of the following methods:

- (a) For hot-start NRTC and RMC NRSC by dividing the sum of the GER at each measurement point by the number of measurement points;
- (b) For discrete-mode NRSC by multiplying the average GER for each test mode by the corresponding weighting factor for that mode and calculating the sum for all modes. The weighting factors shall be taken from Appendix 1 of Annex XVII for the applicable cycle.

7.1. Mass-based emission calculation

Section 2 of Annex VII shall apply except as set out in this section.

7.1.1. Dry/wet correction

7.1.1.1. Raw exhaust gas

Equations (7-3) and (7-4) of Annex VII shall be used to calculate the dry/wet correction.

The fuel specific parameters shall be determined in accordance with point 7.1.5.

7.1.1.2. Diluted exhaust gas

Equation (7-3) with either equation (7-25) or (7-26) of Annex VII shall be used to calculate the wet/dry correction.

The molar hydrogen ratio α of the combination of the two fuels shall be used for the dry/wet correction. This molar hydrogen ratio shall be calculated from the fuel consumption measurement values of both fuels in accordance with point 7.1.5.

7.1.2. NO_x correction for humidity

The NO_x humidity correction for compression ignition engines as specified in equation (7-9) of Annex VII shall be used.

7.1.3. Partial flow dilution (PFS) and raw gaseous measurement

7.1.3.1. Determination of exhaust gas mass flow

The exhaust gas mass flow shall be determined using a raw exhaust flow meter as described in point 9.4.5.3 of Annex VI.

▼B

Alternatively the airflow and air to fuel ratio measurement method according to equations (7-17) to (7-19) of Annex VII may be used only if α , γ , δ and ε values are determined according to point 7.1.5.3. The use of a zirconia-type sensor to determine the air fuel ratio is not allowed.

In the case of testing engines subject to steady-state test cycles only the exhaust gas mass flow may be determined by the air and fuel measurement method in accordance with equation (7-15) of Annex VII.

7.1.3.2. Determination of the gaseous components

Point 2.1 of Annex VII shall apply except as set out in this section.

The possible variation of fuel composition will influence all the u_{gas} factors and molar component ratios used in the emission calculations. One of the following approaches shall be used to determine u_{gas} factors and molar component ratios at the choice of the manufacturer.

- (a) The exact equations in point 2.1.5.2 or 2.2.3 of Annex VII shall be applied to calculate instantaneous values of u_{gas} using the instantaneous proportions of liquid and gaseous fuel (determined from instantaneous fuel consumption measurements or calculations) and instantaneous molar component ratios determined in accordance with point 7.1.5; or,
- (b) When the mass-based calculation in section 2 of Annex VII is used for the specific case of a dual-fuel engine operated on gas and diesel fuel, tabulated values may be used for the molar component ratios and u_{gas} values. These tabulated values shall be applied as follows:
 - (i) For engines operated on the applicable test cycle with an average gas energy ratio greater than or equal to 90 % ($GER \geq 0,9$) the required values shall be those for the gaseous fuel taken from Tables 7.1 or 7.2 of Annex VII.
 - (ii) For engines operated on the applicable test cycle with an average gas energy ratio between 10 % and 90 % ($0,1 < GER < 0,9$) the required values shall be assumed to be represented by those for a mixture of 50 % gaseous fuel and 50 % diesel fuel taken from Tables 8.1 and 8.2.
 - (iii) For engines operated on the applicable test cycle with an average gas energy ratio less than or equal to 10 % ($GER \leq 0,1$) the required values shall be those for diesel fuel taken from taken from Tables 7.1 or 7.2 of Annex VII.
 - (iv) For the calculation of HC emissions the u_{gas} value of the gaseous fuel shall be used in all cases irrespective of the average gas energy ratio (GER).

▼ **B**

Table 8.1

Molar component ratios for a mixture of 50 % gaseous fuel and 50 % diesel fuel (mass %)

Gaseous fuel	α	γ	δ	ε
CH ₄	2,8681	0	0	0,0040
G _R	2,7676	0	0	0,0040
G ₂₃	2,7986	0	0,0703	0,0043
G ₂₅	2,7377	0	0,1319	0,0045
Propane	2,2633	0	0	0,0039
Butane	2,1837	0	0	0,0038
LPG	2,1957	0	0	0,0038
LPG Fuel A	2,1740	0	0	0,0038
LPG Fuel B	2,2402	0	0	0,0039

7.1.3.2.1. Mass per test of a gaseous emission

▼ **M2**

In the case that the exact equations are applied to calculate instantaneous values of u_{gas} in accordance with paragraph 7.1.3.2(a) then, when calculating the mass per test of a gaseous emission for transient (NRTC and LSI-NRTC) test cycles and RMC, u_{gas} shall be included in the summation in equation (7-2) of point 2.1.2 of Annex VII by means of equation (8-1):

▼ **B**

$$m_{\text{gas}} = \frac{1}{f} \cdot k_h \cdot k \cdot \sum_{i=1}^N (u_{\text{gas},i} \cdot q_{\text{mew},i} \cdot c_{\text{gas},i}) \quad (8-1)$$

Where:

$u_{\text{gas},i}$ is the instantaneous value of u_{gas}

The remaining terms of the equation are as set out in point 2.1.2 of Annex VII.

Table 8.2

Raw exhaust gas u_{gas} values and component densities for a mixture of 50 % gaseous fuel and 50 % diesel fuel (mass %)

Gaseous fuel	ρ_e	Gas					
		NO _x	CO	HC	CO ₂	O ₂	CH ₄
				$\rho_{\text{gas}} [\text{kg/m}^3]$			
		2,053	1,250	(^a)	1,9636	1,4277	0,716
				u_{gas} (^b)			
CNG/LNG (^c)	1,2786	0,001606	0,000978	0,000528 (^d)	0,001536	0,001117	0,000560
Propane	1,2869	0,001596	0,000972	0,000510	0,001527	0,001110	0,000556
Butane	1,2883	0,001594	0,000971	0,000503	0,001525	0,001109	0,000556
LPG (^e)	1,2881	0,001594	0,000971	0,000506	0,001525	0,001109	0,000556

(^a) Depending on fuel.

(^b) At $\lambda = 2$, dry air, 273 K, 101,3 kPa.

(^c) u accurate within 0,2 % for mass composition of: C = 58 – 76 %; H = 19 – 25 %; N = 0 – 14 % (CH₄, G₂₀, G₂₃, and G₂₅).

(^d) NMHC on the basis of CH_{2,93} (for total HC the u_{gas} coefficient of CH₄ shall be used).

(^e) u accurate within 0,2 % for mass composition of: C₃ = 27 – 90 %; C₄ = 10 – 73 % (LPG Fuels A and B)

▼ B

7.1.3.3. Particulate determination

For the determination of particulate emissions with the partial dilution measurement method the calculation shall be performed according to the equations in point 2.3 of Annex VII.

▼ M2

The requirements of point 8.2.1.2 of Annex VI shall apply for controlling the dilution ratio. In particular, if the combined transformation time of the exhaust gas flow measurement and the partial flow system exceeds 0,3 s, look-ahead control based on a pre-recorded test run shall be used. In this case, the combined rise time shall be ≤ 1 s and the combined delay time ≤ 10 s. Except in the case that the exhaust gas mass flow is measured directly the determination of exhaust gas mass flow shall use values of α , γ , δ and ε determined in accordance with point 7.1.5.3.

▼ B

The quality check according to point 8.2.1.2 of Annex VI shall be performed for each measurement.

7.1.3.4. Additional requirements regarding the exhaust gas mass flow meter

► **M2** The flow meter referred to in points 9.4.5.3 and 9.4.5.4 of Annex VI shall not be sensitive to the changes in exhaust gas composition and density. ◀ The small errors of e.g. pitot tube or orifice-type of measurement (equivalent with the square root of the exhaust gas density) may be neglected.

7.1.4. Full flow dilution measurement (CVS)

Point 2.2 of Annex VII shall apply except as set out in this section.

The possible variation of the fuel composition will mainly influence the tabulated hydrocarbon u_{gas} value. The exact equations shall be applied for the calculation of the hydrocarbon emissions using the molar component ratios determined from the fuel consumption measurements of both fuels according to point 7.1.5.

▼ M2

7.1.4.1. Determination of the background corrected concentrations

▼ B

To determine the stoichiometric factor, the molar hydrogen ratio α of the fuel shall be calculated as the average molar hydrogen ratio of the fuel mix during the test according to point 7.1.5.3.

Alternatively the F_s value of the gaseous fuel may be used in equation (7-28) of Annex VII.

7.1.5. Determination of molar component ratios

7.1.5.1. General

This section shall be used for the determination of molar component ratios when the fuel mix is known (exact method).

▼ M2

7.1.5.2. Calculation of the fuel mixture components

Equations (8-2) to (8-7) shall be used to calculate the elemental composition of the fuel mixture:

▼ M2

$$q_{mf} = q_{mf1} + q_{mf2} \quad (8-2)$$

$$w_H = \frac{w_{H1} \times q_{mf1} + w_{H2} \times q_{mf2}}{q_{mf1} + q_{mf2}} \quad (8-3)$$

$$w_C = \frac{w_{C1} \times q_{mf1} + w_{C2} \times q_{mf2}}{q_{mf1} + q_{mf2}} \quad (8-4)$$

$$w_S = \frac{w_{S1} \times q_{mf1} + w_{S2} \times q_{mf2}}{q_{mf1} + q_{mf2}} \quad (8-5)$$

$$w_N = \frac{w_{N1} \times q_{mf1} + w_{N2} \times q_{mf2}}{q_{mf1} + q_{mf2}} \quad (8-6)$$

$$w_O = \frac{w_{O1} \times q_{mf1} + w_{O2} \times q_{mf2}}{q_{mf1} + q_{mf2}} \quad (8-7)$$

where:

q_{mf1} is the fuel mass flow rate of fuel 1 [kg/s]

q_{mf2} is the fuel mass flow rate of fuel 2 [kg/s]

w_H is the hydrogen content of fuel [% mass]

w_C is the carbon content of fuel [% mass]

w_S is the sulphur content of fuel [% mass]

w_N is the nitrogen content of fuel [% mass]

w_O is the oxygen content of fuel [% mass]

7.1.5.3. Calculation of the molar ratios of H, C, S, N and O related to C for the fuel mixture

The calculation of the atomic ratios (especially the H/C-ratio α) is given in Annex VII by means of equations (8-8) to (8-11):

$$\alpha = 11,9164 \cdot \frac{w_H}{w_C} \quad (8-8)$$

$$\gamma = 0,37464 \cdot \frac{w_S}{w_C} \quad (8-9)$$

$$\delta = 0,85752 \cdot \frac{w_N}{w_C} \quad (8-10)$$

$$\varepsilon = 0,75072 \cdot \frac{w_O}{w_C} \quad (8-11)$$

where:

w_H is the hydrogen content of fuel, mass fraction [g/g] or [% mass]

w_C is the carbon content of fuel, mass fraction [g/g] or [% mass]

w_S is the sulphur content of fuel, mass fraction [g/g] or [% mass]

w_N is the nitrogen content of fuel, mass fraction [g/g] or [% mass]

w_O is the oxygen content of fuel, mass fraction [g/g] or [% mass]

α is the molar hydrogen ratio (H/C)

γ is the molar sulphur ratio (S/C)

δ is the molar nitrogen ratio (N/C)

ε is the molar oxygen ratio (O/C)

referring to a fuel $CH\alpha O\varepsilon N\delta S\gamma$

▼B

7.2. Molar-based emission calculation

Annex VII section 3 shall apply except as set out in this section.

7.2.1. NO_x correction for humidity

Equation (7-102) of Annex VII (correction for compression ignition engines) shall be used.

7.2.2. Determination of exhaust gas mass flow when not using a raw exhaust flow meter

Equation (7-112) of Annex VII (molar flow rate calculation based on intake air) shall be used. Equation (7-113) of Annex VII (molar flow rate calculation based on fuel mass flow rate) may alternatively be used only when conducting an NRSC test.

7.2.3. Molar component ratios for determination of the gaseous components

The exact approach shall be used to determine the molar component ratios using the instantaneous proportions of liquid and gaseous fuel determined from instantaneous fuel consumption measurements or calculations. ► **M2** The instantaneous molar component ratios shall be input in the equations (7-88), (7-90), and (7-91) of Annex VII for the continuous chemical balance. ◀

The determination of the ratios shall be either performed according to point 7.2.3.1 or point 7.1.5.3.

Gaseous fuels, either blended or sourced from a land line, may contain significant amounts of inert constituents such as CO₂ and N₂. The manufacturer shall either include these constituents in the atomic ratio calculations described in point 7.2.3.1 or point 7.1.5.3 as applicable, or, alternatively, the manufacturer shall exclude the inert constituents from the atomic ratios and allocate them appropriately to the chemical balance intake air parameters $x_{O_{2int}}$, $x_{CO_{2int}}$, and $x_{H_2O_{int}}$ in point 3.4.3 of Annex VII.

7.2.3.1. Determination of molar component ratios

Instantaneous molar component ratios of the number of hydrogen, oxygen, sulphur, and nitrogen atoms to carbons atoms in the mixed fuel for the dual-fuel engines may be calculated by means of equations (8-12) to (8-15):

$$\alpha(t) = \frac{\frac{\dot{m}_{liquid}(t) \times w_{H,liquid}}{M_H} + \frac{\dot{m}_{gas}(t) \times w_{H,gas}}{M_H}}{\frac{\dot{m}_{liquid}(t) \times w_{C,liquid}}{M_C} + \frac{\dot{m}_{gas}(t) \times w_{C,gas}}{M_C}} = \frac{M_C \times [(\dot{m}_{liquid}(t) \times w_{H,liquid}) + (\dot{m}_{gas}(t) \times w_{H,gas})]}{M_H \times [(\dot{m}_{liquid}(t) \times w_{C,liquid}) + (\dot{m}_{gas}(t) \times w_{C,gas})]} \quad (8-12)$$

$$\beta(t) = \frac{\frac{\dot{m}_{liquid}(t) \times w_{O,liquid}}{M_O} + \frac{\dot{m}_{gas}(t) \times w_{O,gas}}{M_O}}{\frac{\dot{m}_{liquid}(t) \times w_{C,liquid}}{M_C} + \frac{\dot{m}_{gas}(t) \times w_{C,gas}}{M_C}} = \frac{M_C \times [(\dot{m}_{liquid}(t) \times w_{O,liquid}) + (\dot{m}_{gas}(t) \times w_{O,gas})]}{M_O \times [(\dot{m}_{liquid}(t) \times w_{C,liquid}) + (\dot{m}_{gas}(t) \times w_{C,gas})]} \quad (8-13)$$

$$\gamma(t) = \frac{\frac{\dot{m}_{liquid}(t) \times w_{S,liquid}}{M_S} + \frac{\dot{m}_{gas}(t) \times w_{S,gas}}{M_S}}{\frac{\dot{m}_{liquid}(t) \times w_{C,liquid}}{M_C} + \frac{\dot{m}_{gas}(t) \times w_{C,gas}}{M_C}} = \frac{M_C \times [(\dot{m}_{liquid}(t) \times w_{S,liquid}) + (\dot{m}_{gas}(t) \times w_{S,gas})]}{M_S \times [(\dot{m}_{liquid}(t) \times w_{C,liquid}) + (\dot{m}_{gas}(t) \times w_{C,gas})]} \quad (8-14)$$

$$\delta(t) = \frac{\frac{\dot{m}_{liquid}(t) \times w_{N,liquid}}{M_N} + \frac{\dot{m}_{gas}(t) \times w_{N,gas}}{M_N}}{\frac{\dot{m}_{liquid}(t) \times w_{C,liquid}}{M_C} + \frac{\dot{m}_{gas}(t) \times w_{C,gas}}{M_C}} = \frac{M_C \times [(\dot{m}_{liquid}(t) \times w_{N,liquid}) + (\dot{m}_{gas}(t) \times w_{N,gas})]}{M_N \times [(\dot{m}_{liquid}(t) \times w_{C,liquid}) + (\dot{m}_{gas}(t) \times w_{C,gas})]} \quad (8-15)$$

Where:

$w_{i,fuel}$ = the mass fraction of the element of interest, C, H, O, S, or N, of liquid or gaseous fuel;

▼ B

$\dot{m}_{liquid}(t)$ = the instantaneous mass flow rate of the liquid fuel at time t, [kg/hr];

$\dot{m}_{gas}(t)$ = the instantaneous mass flow rate of the gaseous fuel at time t, [kg/hr];

▼ M2

In cases where exhaust gas mass flow rate is calculated based on the mixed fuel rate then w_C in equation (7-113) of Annex VII shall be calculated by means of equation (8-16):

▼ B

$$w_C = \frac{\dot{m}_{liquid} \times w_{C,liquid} + \dot{m}_{gas} \times w_{C,gas}}{\dot{m}_{liquid} + \dot{m}_{gas}} \quad (8-16)$$

Where:

w_C = the mass fraction of the carbon in the diesel or gaseous fuel;

\dot{m}_{liquid} = the mass flow rate of the liquid fuel, [kg/hr];

\dot{m}_{gas} = the mass flow rate of the gaseous fuel, [kg/hr].

7.3. CO₂ determination

Annex VII shall apply except when the engine is tested on transient (NRTC and LSI-NRTC) test cycles or RMC using raw gas sampling.

7.3.1 CO₂ determination when testing on transient (NRTC and LSI-NRTC) test cycles or RMC using raw gas sampling

Calculation of CO₂ emissions from measurement of CO₂ in the exhaust gas in accordance with Annex VII shall not apply. Instead the following provisions shall apply:

The measured test-averaged fuel consumption shall be determined from the sum of the instantaneous values over the cycle and shall be used as the base for calculating the test averaged CO₂ emissions.

The mass of each fuel consumed shall be used to determine, in accordance with section 7.1.5, the molar hydrogen ratio and the mass fractions of the fuel mix in the test.

The total corrected fuel mass of both fuels $m_{fuel,corr}$ [g/test] and CO₂ mass emission coming from the fuel $m_{CO_2, fuel}$ [g/test] shall be determined by means of equations (8-17) and (8-18).

$$m_{fuel,corr} = m_{fuel} - \left(m_{THC} + \frac{A_C + a \cdot A_H}{M_{CO}} \cdot m_{CO} + \frac{W_{GAM} + W_{DEL} + W_{EPS}}{100} \cdot m_{fuel} \right) \quad (8-17)$$

$$m_{CO_2, fuel} = \frac{M_{CO_2}}{A_C + a + A_H} \cdot m_{fuel,corr} \quad (8-18)$$

Where:

m_{fuel} = total fuel mass of both fuels [g/test]

m_{THC} = mass of total hydrocarbon emissions in the exhaust gas [g/test]

m_{CO} = mass of carbon monoxide emissions in the exhaust gas [g/test]

▼ B

w_{GAM} = sulphur content of the fuels [per cent mass]

w_{DEL} = nitrogen content of the fuels [per cent mass]

w_{EPS} = is the oxygen content of the fuels [per cent mass]

α = is the molar hydrogen ratio of the fuels (H/C) [-]

A_{C} = is the atomic mass of Carbon: 12,011 [g/mol]

A_{H} = is the atomic mass of Hydrogen: 1,0079 [g/mol]

M_{CO} = is the molecular mass of Carbon monoxide: 28,011 [g/mol]

M_{CO_2} = is the molecular mass of Carbon dioxide: 44,01 [g/mol]

The CO_2 emission resulting from urea $m_{\text{CO}_2,\text{urea}}$ [g/test] shall be calculated by means of equation (8-19):

$$m_{\text{CO}_2,\text{urea}} = \frac{c_{\text{urea}}}{100} \times \frac{M_{\text{CO}_2}}{M_{\text{CO}(\text{NH}_2)_2}} \times m_{\text{urea}} \quad (8-19)$$

Where:

c_{urea} = urea concentration [per cent]

m_{urea} = total urea mass consumption [g/test]

$M_{\text{CO}(\text{NH}_2)_2}$ = Molecular mass of urea: 60,056 [g/mol]

Then the total CO_2 emission m_{CO_2} [g/test] shall be calculated by means of equation (8-20):

$$m_{\text{CO}_2} = m_{\text{CO}_2,\text{fuel}} + m_{\text{CO}_2,\text{urea}} \quad (8-20)$$

The total CO_2 emission calculated by means of equation (8-20) shall be used in the calculation of brake specific CO_2 emissions, e_{CO_2} [g/kWh] in section 2.4.1.1 or 3.8.1.1 of Annex VII. Where applicable, the correction for CO_2 in the exhaust gas arising from CO_2 in the gaseous fuel shall be performed in accordance with Appendix 3 to Annex IX.



Appendix 3

Types of dual-fuel engines operated on natural gas/biomethane or LPG and a liquid fuel — illustration of the definitions and main requirements

Dual-fuel type	GER_{cycle}	Idle on liquid fuel	Warm-up on liquid fuel	Operation on liquid fuel solely	Operation in absence of gas	Comments
1A	$GER_{NRTC, hot} \geq 0,9$ or $GER_{NRSC} \geq 0,9$	NOT allowed	Allowed only on service mode	Allowed only on service mode	Service mode	
1B	$GER_{NRTC, hot} \geq 0,9$ or $GER_{NRSC} \geq 0,9$	Allowed only on liquid-fuel mode	Allowed only on liquid-fuel mode	Allowed only on liquid-fuel and service modes	Liquid-fuel mode	
2A	$0,1 < GER_{NRTC, hot} < 0,9$ or $0,1 < GER_{NRSC} < 0,9$	Allowed	Allowed only on service mode	Allowed only on service mode	Service mode	$GER_{NRTC, hot} \geq 0,9$ or $GER_{NRSC} \geq 0,9$ Allowed
2B	$0,1 < GER_{NRTC, hot} < 0,9$ or $0,1 < GER_{NRSC} < 0,9$	Allowed	Allowed	Allowed	Liquid-fuel mode	$GER_{NRTC, hot} \geq 0,9$ or $GER_{NRSC} \geq 0,9$ allowed
3A	Neither defined nor allowed					
3B	$GER_{NRTC, hot} \leq 0,1$ or $GER_{NRSC} \leq 0,1$	Allowed	Allowed	Allowed	Liquid-fuel mode	



ANNEX IX

Reference Fuels

1. Technical data on fuels for testing compression-ignition engines

1.1. Type: Diesel (non-road gas-oil)

Parameter	Unit	Limits ⁽¹⁾		Test Method
		minimum	maximum	
Cetane number ⁽²⁾		45	56,0	EN-ISO 5165
Density at 15 °C	kg/m ³	833	865	EN-ISO 3675
Distillation:				
50 % point	°C	245	—	EN-ISO 3405
95 % point	°C	345	350	EN-ISO 3405
— Final boiling point	°C	—	370	EN-ISO 3405
Flash point	°C	55	—	EN 22719
CFPP	°C	—	– 5	EN 116
Viscosity at 40 °C	mm ² /s	2,3	3,3	EN-ISO 3104
Polycyclic aromatic hydrocarbons	% m/m	2,0	6,0	IP 391
Sulphur content ⁽³⁾	mg/kg	—	10	ASTM D 5453
Copper corrosion		—	class 1	EN-ISO 2160
Conradson carbon residue (10 % DR)	% m/m	—	0,2	EN-ISO 10370
Ash content	% m/m	—	0,01	EN-ISO 6245
Total contamination	mg/kg	—	24	EN 12662
Water content	% m/m	—	0,02	EN-ISO 12937
Neutralization (strong acid) number	mg KOH/g	—	0,10	ASTM D 974
Oxidation stability ⁽³⁾	mg/ml	—	0,025	EN-ISO 12205
Lubricity (HFRR wear scar diameter at 60 °C)	µm	—	400	CEC F-06-A-96
Oxidation stability at 110 °C ⁽³⁾	H	20,0	—	EN 15751
FAME	% v/v	—	7,0	EN 14078

⁽¹⁾ The values quoted in the specifications are 'true values'. In establishment of their limit values the terms of ISO 4259 'Petroleum products — Determination and application of precision data in relation to methods of test' have been applied and in fixing a minimum value, a minimum difference of 2R above zero has been taken into account; in fixing a maximum and minimum value, the minimum difference is 4R (R = reproducibility).

Notwithstanding this measure, which is necessary for technical reasons, the manufacturer of fuels should nevertheless aim at a zero value where the stipulated maximum value is 2R and at the mean value in the case of quotations of maximum and minimum limits. Should it be necessary to clarify the questions as to whether a fuel meets the requirements of the specifications, the terms of ISO 4259 should be applied.

⁽²⁾ The range for the cetane number is not in accordance with the requirements of a minimum range of 4R. However, in the case of a dispute between fuel supplier and fuel user, the terms of ISO 4259 may be used to resolve such disputes provided replicate measurements, of sufficient number to archive the necessary precision, are made in preference to single determinations.

⁽³⁾ Even though oxidation stability is controlled, it is likely that shelf life will be limited. Advice should be sought from the supplier as to storage conditions and life.

▼B

1.2. Type: Ethanol for dedicated compression ignition engines (ED95) ⁽¹⁾

Parameter	Unit	Limits ⁽²⁾		Test method ⁽³⁾
		Minimum	Maximum	
Total alcohol (Ethanol incl. content on higher saturated alcohols)	% m/m	92,4		EN 15721
Other higher saturated mono-alcohols (C ₃ -C ₅)	% m/m		2,0	EN 15721
Methanol	% m/m		0,3	EN 15721
Density 15 °C	kg/m ³	793,0	815,0	EN ISO 12185
Acidity, calculated as acetic acid	% m/m		0,0025	EN 15491
Appearance		Bright and clear		
Flashpoint	°C	10		EN 3679
Dry residue	mg/kg		15	EN 15691
Water content	% m/m		6,5	EN 15489 ⁽⁴⁾ EN-ISO 12937 EN15692
Aldehydes calculated as acetaldehyde	% m/m		0,0050	ISO 1388-4
Esters calculated as ethylacetat	% m/m		0,1	ASTM D1617
Sulphur content	mg/kg		10,0	EN 15485 EN 15486
Sulphates	mg/kg		4,0	EN 15492
Particulate contamination	mg/kg		24	EN 12662
Phosphorus	mg/l		0,20	EN 15487
Inorganic chloride	mg/kg		1,0	EN 15484 or EN 15492
Copper	mg/kg		0,100	EN 15488
Electrical Conductivity	µS/cm		2,50	DIN 51627-4 or prEN 15938

Notes:

⁽¹⁾ Additives, such as cetane improver as specified by the engine manufacturer, may be added to the ethanol fuel, as long as no negative side effects are known. If these conditions are satisfied, the maximum allowed amount is 10 % m/m.

⁽²⁾ The values quoted in the specifications are 'true values'. In establishment of their limit values the terms of ISO 4259 Petroleum products — Determination and application of precision data in relation to methods of test have been applied and in fixing a minimum value, a minimum difference of 2R above zero has been taken into account; in fixing a maximum and minimum value, the minimum difference is 4R (R = reproducibility). Notwithstanding this measure, which is necessary for technical reasons, the manufacturer of fuels shall nevertheless aim at a zero value where the stipulated maximum value is 2R and at the mean value in the case of quotations of maximum and minimum limits. Should it be necessary to clarify whether a fuel meets the requirements of the specifications, the terms of ISO 4259 shall be applied.

⁽³⁾ Equivalent EN/ISO methods will be adopted when issued for properties listed above.

⁽⁴⁾ Should it be necessary to clarify whether a fuel meets the requirements of the specifications, the terms of EN 15489 shall be applied.

▼B

2. Technical data on fuels for testing spark ignition engines

2.1. Type: Petrol (E10)

Parameter	Unit	Limits ⁽¹⁾		Test method ⁽²⁾
		Minimum	Maximum	
Research octane number, RON		91,0	98,0	EN ISO 5164: 2005 ⁽³⁾
Motor octane number, MON		83,0	89,0	EN ISO 5163: 2005 ⁽³⁾
Density at 15 °C	kg/m ³	743	756	EN ISO 3675 EN ISO 12185
Vapour pressure	kPa	45,0	60,0	EN ISO 13016-1 (DVPE)
Water content			Max 0,05 % v/v Appearance at – 7 °C: clear and bright	EN 12937
Distillation:				
— evaporated at 70 °C	% v/v	18,0	46,0	EN-ISO 3405
— evaporated at 100 °C	% v/v	46,0	62,0	EN-ISO 3405
— evaporated at 150 °C	% v/v	75,0	94,0	EN-ISO 3405
— final boiling point	°C	170	210	EN-ISO 3405
Residue	% v/v	—	2,0	EN-ISO 3405
Hydrocarbon analysis:				
— olefins	% v/v	3,0	18,0	EN 14517 EN 15553
— aromatics	% v/v	19,5	35,0	EN 14517 EN 15553
— benzene	% v/v	—	1,0	EN 12177 EN 238, EN 14517
— saturates	% v/v	Report		EN 14517 EN 15553
Carbon/hydrogen ratio		Report		
Carbon/oxygen ratio		Report		
Induction period ⁽⁴⁾	minutes	480		EN-ISO 7536
Oxygen content ⁽⁵⁾	% m/m	3,3 ⁽⁸⁾	3,7	EN 1601 EN 13132 EN 14517
Existent gum	mg/ml	—	0,04	EN-ISO 6246

▼B

Parameter	Unit	Limits ⁽¹⁾		Test method ⁽²⁾
		Minimum	Maximum	
Sulphur content ⁽⁶⁾	mg/kg	—	10	EN ISO 20846 EN ISO 20884
Copper corrosion (3h at 50 °C)	rating	—	Class 1	EN-ISO 2160
Lead content	mg/l	—	5	EN 237
Phosphorus content ⁽⁷⁾	mg/l	—	1,3	ASTM D 3231
Ethanol ⁽⁴⁾	% v/v	9,0 ⁽⁸⁾	10,2 ⁽⁸⁾	EN 22854

Notes:

- (1) The values quoted in the specifications are 'true values'. In establishment of their limit values the terms of ISO 4259 Petroleum products — Determination and application of precision data in relation to methods of test have been applied and in fixing a minimum value, a minimum difference of 2R above zero has been taken into account; in fixing a maximum and minimum value, the minimum difference is 4R (R = reproducibility). Notwithstanding this measure, which is necessary for technical reasons, the manufacturer of fuels shall nevertheless aim at a zero value where the stipulated maximum value is 2R and at the mean value in the case of quotations of maximum and minimum limits. Should it be necessary to clarify whether a fuel meets the requirements of the specifications, the terms of ISO 4259 shall be applied.
- (2) Equivalent EN/ISO methods will be adopted when issued for properties listed above.
- (3) A correction factor of 0,2 for MON and RON shall be subtracted for the calculation of the final result in accordance with EN 228:2008.
- (4) The fuel may contain oxidation inhibitors and metal deactivators normally used to stabilise refinery gasoline streams, but detergent/dispersive additives and solvent oils shall not be added.
- (5) Ethanol meeting the specification of EN 15376 is the only oxygenate that shall be intentionally added to the reference fuel.
- (6) The actual sulphur content of the fuel used for the Type 1 test shall be reported.
- (7) There shall be no intentional addition of compounds containing phosphorus, iron, manganese, or lead to this reference fuel.
- (8) The ethanol content and corresponding oxygen content may be zero for engines of category SMB at the choice of the manufacturer. In this case all testing of the engine family, or engine type where no family exists, shall be conducted using petrol with zero ethanol content.

2.2. Type: Ethanol (E85)

Parameter	Unit	Limits ⁽¹⁾		Test method
		Minimum	Maximum	
Research octane number, RON		95,0	—	EN ISO 5164
Motor octane number, MON		85,0	—	EN ISO 5163
Density at 15 °C	kg/m ³	Report		ISO 3675
Vapour pressure	kPa	40,0	60,0	EN ISO 13016-1 (DVPE)
Sulphur content ⁽²⁾	mg/kg	—	10	EN 15485 or EN 15486
Oxidation stability	Minutes	360		EN ISO 7536
Existent gum content (solvent washed)	mg/100ml	—	5	EN-ISO 6246
Appearance This shall be determined at ambient temperature or 15 °C whichever is higher		Clear and bright, visibly free of suspended or precipitated contaminants		Visual inspection



Parameter	Unit	Limits ⁽¹⁾		Test method
		Minimum	Maximum	
Ethanol and higher alcohols ⁽³⁾	% v/v	83	85	EN 1601 EN 13132 EN 14517 E DIN 51627-3
Higher alcohols (C ₃ -C ₈)	% v/v	—	2,0	E DIN 51627-3
Methanol	% v/v		1,00	E DIN 51627-3
Petrol ⁽⁴⁾	% v/v	Balance		EN 228
Phosphorus	mg/l	0,20 ⁽⁵⁾		EN 15487
Water content	% v/v		0,300	EN 15489 or EN 15692
Inorganic chloride content	mg/l		1	EN 15492
pHe		6,5	9,0	EN 15490
Copper strip corrosion (3h at 50 °C)	Rating	Class 1		EN ISO 2160
Acidity, (as acetic acid CH ₃ COOH)	% m/m (mg/l)	—	0,0050 (40)	EN 15491
Electric Conductivity	µS/cm	1,5		DIN 51627-4 or prEN 15938
Carbon/hydrogen ratio		Report		
Carbon/oxygen ratio		Report		

Notes:

⁽¹⁾ The values quoted in the specifications are 'true values'. In establishment of their limit values the terms of ISO 4259 Petroleum products — Determination and application of precision data in relation to methods of test have been applied and in fixing a minimum value, a minimum difference of 2R above zero has been taken into account; in fixing a maximum and minimum value, the minimum difference is 4R (R = reproducibility). Notwithstanding this measure, which is necessary for technical reasons, the manufacturer of fuels shall nevertheless aim at a zero value where the stipulated maximum value is 2R and at the mean value in the case of quotations of maximum and minimum limits. Should it be necessary to clarify whether a fuel meets the requirements of the specifications, the terms of ISO 4259 shall be applied.

⁽²⁾ The actual sulphur content of the fuel used for the emission tests shall be reported.

⁽³⁾ Ethanol to meet specification of EN 15376 is the only oxygenate that shall be intentionally added to this reference fuel.

⁽⁴⁾ The unleaded petrol content can be determined as 100 minus the sum of the % content of water, alcohols, MTBE and ETBE.

⁽⁵⁾ There shall be no intentional addition of compounds containing phosphorus, iron, manganese, or lead to this reference fuel.

3. Technical data on gaseous fuels for single-fuel and dual-fuel engines

3.1. Type: LPG

Parameter	Unit	Fuel A	Fuel B	Test method
Composition:				EN 27941
C ₃ -content	% v/v	30 ± 2	85 ± 2	
C ₄ -content	% v/v	Balance ⁽¹⁾	Balance ⁽¹⁾	
< C ₃ , > C ₄	% v/v	Maximum 2	Maximum 2	

▼B

Parameter	Unit	Fuel A	Fuel B	Test method
Olefins	% v/v	Maximum 12	Maximum 15	
Evaporation residue	mg/kg	Maximum 50	Maximum 50	EN 15470
Water at 0 °C		Free	Free	EN 15469
Total sulphur content including odorant	mg/kg	Maximum 10	Maximum 10	EN 24260, ASTM D 3246, ASTM 6667
Hydrogen sulphide		None	None	EN ISO 8819
Copper strip corrosion (1h at 40 °C)	Rating	Class 1	Class 1	ISO 6251 ⁽²⁾
Odour		Characteristic	Characteristic	
Motor octane number ⁽³⁾		Minimum 89,0	Minimum 89,0	EN 589 Annex B

Notes:

⁽¹⁾ Balance shall be read as follows: balance = 100 – C₃ – < C₃ – > C₄.

⁽²⁾ This method may not accurately determine the presence of corrosive materials if the sample contains corrosion inhibitors or other chemicals which diminish the corrosivity of the sample to the copper strip. Therefore, the addition of such compounds for the sole purpose of biasing the test method is prohibited.

⁽³⁾ At the request of the engine manufacturer, a higher MON could be used to perform the type approval tests.

3.2. Type: Natural Gas/ Biomethane

3.2.1. Specification for reference fuels supplied with fixed properties (e.g. from a sealed container)

As an alternative to the reference fuels set out in this point, the equivalent fuels in point 3.2.2 may be used

Characteristics	Units	Basis	Limits		Test method
			minimum	maximum	

Reference fuel G_R

Composition:					
Methane		87	84	89	
Ethane		13	11	15	
Balance ⁽¹⁾	% mole	—	—	1	ISO 6974
Sulphur content	mg/m ³ ⁽²⁾	—		10	ISO 6326-5

Notes:

⁽¹⁾ Inerts + C₂₊

⁽²⁾ Value to be determined at standard conditions 293,2 K (20 °C) and 101,3 kPa.

Reference fuel G₂₃

Composition:					
Methane		92,5	91,5	93,5	
Balance ⁽¹⁾	% mole	—	—	1	ISO 6974
N ₂	% mole	7,5	6,5	8,5	



Characteristics	Units	Basis	Limits		Test method
			minimum	maximum	
Sulphur content	mg/m ³ ⁽²⁾	—	—	10	ISO 6326-5

Notes:

⁽¹⁾ Inerts (different from N₂) + C₂+ C₂₊

⁽²⁾ Value to be determined at 293,2 K (20 °C) and 101,3 kPa.

Reference fuel G₂₅

Composition:					
Methane	% mole	86	84	88	
Balance ⁽¹⁾	% mole	—	—	1	ISO 6974
N ₂	% mole	14	12	16	
Sulphur content	mg/m ³ ⁽²⁾	—	—	10	ISO 6326-5

Notes:

⁽¹⁾ Inerts (different from N₂) + C₂+ C₂₊

⁽²⁾ Value to be determined at 293,2 K (20 °C) and 101,3 kPa.

Reference fuel G₂₀

Composition:					
Methane	% mole	100	99	100	ISO 6974
Balance ⁽¹⁾	% mole	—	—	1	ISO 6974
N ₂	% mole				ISO 6974
Sulphur content	mg/m ³ ⁽²⁾	—	—	10	ISO 6326-5
Wobbe Index (net)	MJ/m ³ ⁽³⁾	48,2	47,2	49,2	

⁽¹⁾ Inerts (different from N₂) + C₂ + C₂₊.

⁽²⁾ Value to be determined at 293,2 K (20 °C) and 101,3 kPa.

⁽³⁾ Value to be determined at 273,2 K (0 °C) and 101,3 kPa.

- 3.2.2. Specification for reference fuel supplied from a pipeline with admixture of other gases with gas properties determined by on-site measurement

As an alternative to the reference fuels in this point the equivalent reference fuels in point 3.2.1 may be used.

- 3.2.2.1. The basis of each pipeline reference fuel (G_R, G₂₀, ...) shall be gas drawn from a utility gas distribution network, blended, where necessary to meet the corresponding lambda-shift (S_λ) specification in Table 9.1, with an admixture of one or more of the following commercially ⁽¹⁾ available gases:

- (a) Carbon dioxide;
- (b) Ethane;
- (c) Methane;
- (d) Nitrogen;
- (e) Propane.

⁽¹⁾ The use of calibration gas for this purpose shall not be required.

▼B

3.2.2.2. The value of S_λ of the resulting blend of pipeline gas and admixture gas shall be within the range specified in Table 9.1 for the specified reference fuel.

Table 9.1

Required range of S_λ for each reference fuel

Reference fuel	Minimum S_λ	Maximum S_λ
G_R ⁽¹⁾	0,87	0,95
G_{20}	0,97	1,03
G_{23}	1,05	1,10
G_{25}	1,12	1,20

⁽¹⁾ The engine shall not be required to be tested on a gas blend with a Methane Number (MN) less than 70. In the case that the required range of S_λ for G_R would result in an MN less than 70 the value of S_λ for G_R may be adjusted as necessary until a value of MN no less than 70 is attained.

3.2.2.3. The engine test report for each test run shall include the following:

- (a) The admixture gas(es) chosen from the list in point 3.2.2.1;
- (b) The value of S_λ for the resulting fuel blend;
- (c) The Methane Number (MN) of the resulting fuel blend.

3.2.2.4. The requirements of Appendices 1 and 2 shall be met in respect to determination of the properties of the pipeline and admixture gases, the determination of S_λ and MN for the resulting gas blend, and the verification that the blend was maintained during the test.

3.2.2.5. In the case that one or more of the gas streams (pipeline gas or admixture gas(es)) contain CO_2 in greater than a *de minimus* proportion, the calculation of specific CO_2 emissions in Annex VII shall be corrected according to Appendix 3.

*Appendix 1***Supplementary requirements for conducting emission testing using gaseous reference fuels comprising pipeline gas with admixture of other gases****1. Method of gas analysis and gas flow measurement**

- 1.1. For the purpose of this Appendix, where required the composition of the gas shall be determined by analysis of the gas using gas chromatography according to EN ISO 6974, or by an alternative technique that achieves at least a similar level of accuracy and repeatability.
- 1.2. For the purpose of this Appendix, where required the measurement of gas flow shall be performed using a mass-based flowmeter.

2. Analysis and flowrate of incoming utility gas supply

- 2.1. The composition of the utility gas supply shall be analysed prior to the admixture blending system.
- 2.2. The flowrate of the utility gas entering the admixture blending system shall be measured.

3. Analysis and flowrate of admixture

- 3.1. When an applicable certificate of analysis is available for an admixture (for example issued by the gas supplier) this may be used as the source of that admixture composition. In this case the on-site analysis of that admixture composition shall be permitted but shall not be required.
- 3.2. Where an applicable certificate of analysis is not available for an admixture the composition of that admixture shall be analysed.
- 3.3. The flowrate of each admixture entering the admixture blending system shall be measured.

4. Analysis of blended gas

- 4.1. The analysis of the composition of the gas supplied to the engine after leaving the admixture blending system shall be permitted in addition to, or as an alternative to the analysis required by points 2.1 and 3.1, but shall not be required.

5. Calculation of S_{λ} and MN of the blended gas

- 5.1. The results of the gas analysis according to point 2.1, point 3.1 or 3.2 and, where applicable, point 4.1, combined with the mass flowrate of gas measured according to points 2.2 and 3.3, shall be used to calculate the MN according to EN16726:2015. The same set of data shall be used to calculate S_{λ} according to the procedure set out in Appendix 2.

6. Control and verification of gas blend during the test

- 6.1. The control and verification of the gas blend during the test shall be performed using either an open loop or closed loop control system.
- 6.2. Open loop blend control system
 - 6.2.1. In this case the gas analysis, flow measurements and calculations set out in points 1, 2, 3 and 4 shall be performed prior to the emission test.
 - 6.2.2. The proportion of utility gas and admixture(s) shall be set to ensure that the S_{λ} is within the permitted range for the relevant reference fuel in Table 9.1.

▼B

- 6.2.3 When the relative proportions have been set they shall be maintained throughout the emission test. Adjustments to individual flow rates to maintain the relative proportions shall be permitted.
- 6.2.4 When the emission test has been completed the analysis of gas composition, flow measurements and calculations set out in points 2, 3, 4 and 5 shall be repeated. In order for the test to be considered valid the value of S_{λ} shall remain within the specified range for the respective reference fuel given in Table 9.1.
- 6.3 Closed loop blend control system
- 6.3.1 In this case the analysis of gas composition, flow measurements and calculations set out in points 2, 3, 4 and 5 shall be performed at intervals during the emission test. The intervals shall be chosen taking into consideration the frequency capability of the gas chromatograph and corresponding calculation system.
- 6.3.2 The results from the periodic measurements and calculations shall be used to adjust the relative proportions of utility gas and admixture in order to maintain the value of S_{λ} within the range specified in Table 9.1 for the respective reference fuel. The frequency of adjustment shall not exceed the frequency of measurement.
- 6.3.3 In order for the test to be considered valid the value of S_{λ} shall be within the range specified in Table 9.1 for the respective reference fuel for at least 90 % of the measurement points.

▼ **B**

Appendix 2

Calculation of λ -Shift factor (S_λ)

1. Calculation

The λ -shift factor (S_λ)⁽¹⁾ shall be calculated by means of equation (9-1):

$$S_\lambda = \frac{2}{\left(1 - \frac{\text{inert}\%}{100}\right) \left(n + \frac{m}{4}\right) - \frac{O_2^*}{100}} \quad (9-1)$$

Where:

S_λ = λ -shift factor;

inert % = % by volume of inert gases in the fuel (i.e. N₂, CO₂, He, etc.);

O₂^{*} = % by volume of original oxygen in the fuel;

n and m = refer to average C_nH_m representing the fuel hydrocarbons, i.e.:

$$n = \frac{1 \times \left[\frac{\text{CH}_4\%}{100}\right] + 2 \times \left[\frac{\text{C}_2\%}{100}\right] + 3 \times \left[\frac{\text{C}_3\%}{100}\right] + 4 \times \left[\frac{\text{C}_4\%}{100}\right] + 5 \times \left[\frac{\text{C}_5\%}{100} + \dots\right]}{\frac{1 - \text{diluent}\%}{100}} \quad (9-2)$$

$$m = \frac{4 \times \left[\frac{\text{CH}_4\%}{100}\right] + 4 \times \left[\frac{\text{C}_2\text{H}_4\%}{100}\right] + 6 \times \left[\frac{\text{C}_2\text{H}_6\%}{100} + \dots\right] + 8 \times \left[\frac{\text{C}_3\text{H}_8\%}{100} + \dots\right]}{\frac{1 - \text{diluent}\%}{100}} \quad (9-3)$$

Where:

CH₄ = % by volume of methane in the fuel;

C₂ = % by volume of all C₂ hydrocarbons (e.g.: C₂H₆, C₂H₄, etc.) in the fuel;

C₃ = % by volume of all C₃ hydrocarbons (e.g.: C₃H₈, C₃H₆, etc.) in the fuel;

C₄ = % by volume of all C₄ hydrocarbons (e.g.: C₄H₁₀, C₄H₈, etc.) in the fuel;

C₅ = % by volume of all C₅ hydrocarbons (e.g.: C₅H₁₂, C₅H₁₀, etc.) in the fuel;

diluent = % by volume of dilution gases in the fuel (i.e.: O₂^{*}, N₂, CO₂, He, etc.).

2. Examples for the calculation of the λ -shift factor S_λ :

Example 1: G₂₅: CH₄ = 86 %, N₂ = 14 % (by volume)

$$n = \frac{1 \times \left[\frac{\text{CH}_4\%}{100}\right] + 2 \times \left[\frac{\text{C}_2\%}{100}\right] + \dots}{\frac{1 - \text{diluent}\%}{100}} = \frac{1 \times 0,86}{1 - \frac{14}{100}} = \frac{0,86}{0,86} = 1$$

$$m = \frac{4 \times \left[\frac{\text{CH}_4\%}{100}\right] + 4 \times \left[\frac{\text{C}_2\text{H}_4\%}{100}\right] + \dots}{\frac{1 - \text{diluent}\%}{100}} = \frac{4 \times 0,86}{0,86} = 4$$

⁽¹⁾ Stoichiometric Air/Fuel ratios of automotive fuels — SAE J1829, June 1987. John B. Heywood, Internal combustion engine fundamentals, McGraw-Hill, 1988, Chapter 3.4 'Combustion stoichiometry' (pp. 68 to 72).

▼ **B**

$$S_\lambda = \frac{2}{\left(1 - \frac{\text{inert}\%}{100}\right) \left(n + \frac{m}{4}\right) - \frac{O_2\%}{100}} = \frac{2}{\left(1 - \frac{14}{100}\right) \times \left(1 + \frac{4}{4}\right)} = 1,16$$

Example 2: G_R : $CH_4 = 87\%$, $C_2H_6 = 13\%$ (by vol)

$$n = \frac{1 \times \left[\frac{CH_4\%}{100}\right] + 2 \times \left[\frac{C_2\%}{100}\right] + \dots}{\frac{1 - \text{diluent}\%}{100}} = \frac{1 \times 0,87 + 2 \times 0,13}{1 - \frac{0}{100}} = \frac{1,13}{1} = 1,13$$

$$m = \frac{4 \times \left[\frac{CH_4\%}{100}\right] + 2 \times \left[\frac{C_2H_4\%}{100}\right] + \dots}{\frac{1 - \text{diluent}\%}{100}} = \frac{4 \times 0,87 + 6 \times 0,13}{1} = 4,26$$

$$S_\lambda = \frac{2}{\left(1 - \frac{\text{inert}\%}{100}\right) \left(n + \frac{m}{4}\right) - \frac{O_2\%}{100}} = \frac{2}{\left(1 - \frac{0}{100}\right) \times \left(1,13 + \frac{4,26}{4}\right)} = 0,911$$

Example 3: USA: $CH_4 = 89\%$, $C_2H_6 = 4,5\%$, $C_3H_8 = 2,3\%$, $C_6H_{14} = 0,2\%$,
 $O_2 = 0,6\%$, $N_2 = 4\%$

$$n = \frac{1 \times \left[\frac{CH_4\%}{100}\right] + 2 \times \left[\frac{C_2\%}{100}\right] + \dots}{\frac{1 - \text{diluent}\%}{100}} = \frac{1 \times 0,89 + 2 \times 0,045 + 3 \times 0,023 + 4 \times 0,002}{1 - \frac{0,64+4}{100}} = 1,11$$

$$m = \frac{4 \times \left[\frac{CH_4\%}{100}\right] + 2 \times \left[\frac{C_2H_4\%}{100}\right] + 6 \times \left[\frac{C_2H_6\%}{100}\right] + \dots + 8 \times \left[\frac{C_3H_8\%}{100}\right]}{\frac{1 - \text{diluent}\%}{100}} = \frac{4 \times 0,89 + 4 \times 0,045 + 8 \times 0,023 + 14 \times 0,002}{1 - \frac{0,6+4}{100}} = 4,24$$

$$S_\lambda = \frac{2}{\left(1 - \frac{\text{inert}\%}{100}\right) \left(n + \frac{m}{4}\right) - \frac{O_2\%}{100}} = \frac{2}{\left(1 - \frac{4}{100}\right) \times \left(1,11 + \frac{4,24}{4}\right) - \frac{0,6}{100}} = 0,96$$

As an alternative to the above equation, S_λ may be calculated from the ratio of the stoichiometric air demand of pure methane to the stoichiometric air demand of the fuel blend supplied to the engine, as specified below.

Lambda-shift factor (S_λ) expresses the oxygen demand of any fuel blend in relation to oxygen demand of pure methane. Oxygen demand means the amount of oxygen to oxidise methane in a stoichiometric composition of reaction partners to products of complete combustion (i.e. carbon-dioxide and water).

For the combustion of pure methane the reaction is as set out in equation (9-4):

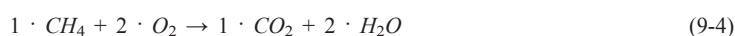

In this case the ratio of molecules in stoichiometric composition of reaction partners is exactly 2:

$$\frac{n_{O_2}}{n_{CH_4}} = 2$$

Where:

n_{O_2} = number of molecules of oxygen

n_{CH_4} = number of molecules of methane

▼ B

The oxygen demand for pure methane is therefore:

$$n_{O_2} = 2 \cdot n_{CH_4} \text{ with a reference value of } [n_{CH_4}] = 1 \text{ kmol}$$

▼ M2

The value of S_λ may be determined from the ratio of the ratio of the stoichiometric composition of oxygen and methane to the ratio of the stoichiometric composition of oxygen and the fuel blend supplied to the engine, as set out in equation (9-5):

▼ B

$$S_\lambda = \frac{\left(\frac{n_{O_2}}{n_{CH_4}}\right)}{\left(\frac{n_{O_2}}{n_{blend}}\right)} = \frac{2}{(n_{O_2})_{blend}} \quad (9-5)$$

Where:

n_{blend} = number of molecules of the fuel blend

$(n_{O_2})_{blend}$ = the ratio of the molecules in the stoichiometric composition of oxygen and the fuel blend supplied to the engine

Because air contains 21 % oxygen the stoichiometric air demand L_{st} of any fuel shall be calculated by means of equation (9-6):

$$L_{st, fuel} = \frac{n_{O_2, fuel}}{0,21} \quad (9-6)$$

Where:

$L_{st, fuel}$ = the stoichiometric air demand for the fuel

$n_{O_2, fuel}$ = the stoichiometric oxygen demand for the fuel

Consequently the value of S_λ may also be determined from the ratio of the stoichiometric composition of air and methane to the ratio of the stoichiometric composition of air and the fuel blend supplied to the engine, i.e. the ratio of the stoichiometric air demand of methane to that of the fuel blend supplied to the engine, as set out in equation (9-7):

$$S_\lambda = \frac{\left(\frac{n_{O_2}}{n_{CH_4}}\right)/0,21}{\left(\frac{n_{O_2}}{n_{blend}}\right)/0,21} = \frac{\left(\frac{n_{O_2}}{0,21}\right)_{CH_4}}{\left(\frac{n_{O_2}}{0,21}\right)_{blend}} = \frac{L_{st, CH_4}}{L_{st, blend}} \quad (9-7)$$

Therefore, any calculation that specifies the stoichiometric air demand may be used to express the Lambda-shift factor.

▼ B*Appendix 3***Correction for CO₂ in the exhaust gas arising from CO₂ in the gaseous fuel****1. Instantaneous mass flow rate of CO₂ in the gaseous fuel stream**

- 1.1. Gas composition and gas flow shall be determined according to the requirements of sections 1 to 4 of Appendix 1.
- 1.2. The instantaneous mass flow rate of CO₂ in a stream of gas supplied to the engine shall be calculated by means of equation (9-8).

$$\dot{m}_{\text{CO}_2\text{i}} = (M_{\text{CO}_2}/M_{\text{stream}}) \cdot x_{\text{CO}_2\text{i}} \cdot \dot{m}_{\text{streami}} \quad (9-8)$$

Where:

$\dot{m}_{\text{CO}_2\text{i}}$ = Instantaneous mass flow rate of CO₂ from the gas stream [g/s]

\dot{m}_{streami} = Instantaneous mass flow rate of the gas stream [g/s]

$x_{\text{CO}_2\text{i}}$ = Molar fraction of CO₂ in the gaseous stream [-]

M_{CO_2} = Molar mass of CO₂ [g/mol]

M_{stream} = Molar mass of gas stream [g/mol]

M_{stream} shall be calculated from all measured constituents (1, 2, ..., n) by means of equation (9-9).

$$M_{\text{stream}} = x_1 \cdot M_1 + x_2 \cdot M_2 + \dots + x_n \cdot M_n \quad (9-9)$$

Where:

$x_{1, 2, \dots, n}$ = Molar fraction of each measured constituent in the gas stream (CH₄, CO₂, ...) [-]

$M_{1, 2, \dots, n}$ = Molar mass of each measured constituent in the gas stream [g/mol]

- 1.3. In order to determine the total mass flow rate of CO₂ in the gaseous fuel entering the engine the calculation in equation (9-8) shall be performed for each individual gas stream containing CO₂ that is entering the gas blending system and the result for each gas stream added together, or it shall be performed for the blended gas leaving the blending system and entering the engine by means of equation (9-10):

$$\dot{m}_{\text{CO}_2\text{i, fuel}} = \dot{m}_{\text{CO}_2\text{i, a}} + \dot{m}_{\text{CO}_2\text{i, b}} + \dots + \dot{m}_{\text{CO}_2\text{i, n}} \quad (9-10)$$

Where:

$\dot{m}_{\text{CO}_2\text{i, fuel}}$ = instantaneous combined mass flow rate of CO₂ arising from the CO₂ in the gaseous fuel entering the engine [g/s]

$\dot{m}_{\text{CO}_2\text{i, a, b, \dots, n}}$ = instantaneous mass flow rate of CO₂ arising from the CO₂ in each individual gas stream a, b, ..., n [g/s]

▼ B**2. Calculation of specific CO₂ emissions for transient (NRTC and LSI-NRTC) test cycles and RMC**

- 2.1 The total mass per test of CO₂ emission from the CO₂ in the fuel $m_{\text{CO}_2, \text{fuel}}$ [g/test] shall be calculated by summation of the instantaneous mass flow rate of CO₂ in the gaseous fuel entering the engine $\dot{m}_{\text{CO}_2, \text{fuel}}$ [g/s] over the test cycle by means of equation (9-11):

$$m_{\text{CO}_2, \text{fuel}} = \frac{1}{f} \cdot \sum_{i=1}^N \dot{m}_{\text{CO}_2, \text{fuel}} \quad (9-11)$$

Where:

f = data sampling rate [Hz]

N = number of measurements [-]

- 2.2 The total mass of CO₂ emission m_{CO_2} [g/test] used in equation (7-61), (7-63), (7-128) or (7-130) of Annex VII to calculate the specific emissions result e_{CO_2} [g/kWh] shall be replaced in those equations by the corrected value $m_{\text{CO}_2, \text{corr}}$ [g/test] calculated by means of equation (9-12).

$$m_{\text{CO}_2, \text{corr}} = m_{\text{CO}_2} - m_{\text{CO}_2, \text{fuel}} \quad (9-12)$$

3. Calculation of specific CO₂ emissions for discrete-mode NRSC

- 3.1 The mean mass flow of CO₂ emission from the CO₂ in the fuel per hour $q_{m\text{CO}_2, \text{fuel}}$ or $\dot{m}_{\text{CO}_2, \text{fuel}}$ [g/h] shall be calculated for each individual test mode from the measurements of instantaneous mass flow rate of CO₂ $\dot{m}_{\text{CO}_2, \text{fuel}}$ [g/s] given by equation (9-10) taken during the sampling period of the respective test mode by means of equation (9-13):

$$q_{m\text{CO}_2, \text{fuel}} = \dot{m}_{\text{CO}_2, \text{fuel}} = \frac{1}{3\,600 \cdot N} \cdot \sum_{i=1}^N \dot{m}_{\text{CO}_2, \text{fuel}} \quad (9-13)$$

Where:

N = number of measurements taken during the test mode [-]

- 3.2 The mean mass flow rate of CO₂ emission $q_{m\text{CO}_2}$ or \dot{m}_{CO_2} [g/h] for each individual test mode used in equation (7-64) or (7-131) of Annex VII to calculate the specific emissions result e_{CO_2} [g/kWh] shall be replaced in those equations by the corrected value $q_{m\text{CO}_2, \text{corr}}$ or $\dot{m}_{\text{CO}_2, \text{corr}}$ [g/h] for each individual test mode calculated by means of equation (9-14) or (9-15).

$$q_{m\text{CO}_2, \text{corr}} = q_{m\text{CO}_2} - q_{m\text{CO}_2, \text{fuel}} \quad (9-14)$$

$$\dot{m}_{\text{CO}_2, \text{corr}} = \dot{m}_{\text{CO}_2} - \dot{m}_{\text{CO}_2, \text{fuel}} \quad (9-15)$$



ANNEX X

Detailed technical specifications and conditions for delivering an engine separately from its exhaust after-treatment system

1. Separate shipment, as set out in Article 34(3) of Regulation (EU) 2016/1628, occurs when the manufacturer and the OEM installing the engine are separate legal entities and the engine is shipped by the manufacturer from one location separately from its exhaust after-treatment system, and the exhaust after-treatment system is delivered from a different location and / or at a different moment in time.
2. **In this case, the manufacturer shall:**
 - 2.1. Be considered responsible for the placing on the market of the engine and for ensuring that the engine is brought into conformity with the approved engine type;
 - 2.2. Place all orders for the parts shipped separately before shipping the engine separately from its exhaust after-treatment system to the OEM;
 - 2.3. Make available to the OEM the instructions for installation of the engine, including the exhaust after-treatment system, and the identification marking of the parts shipped separately as well as the information necessary for checking the proper functioning of the assembled engine according to the approved engine type or engine family.
 - 2.4. Keep records of:
 - (1) the instructions made available to the OEM;
 - (2) the list of all parts delivered separately;
 - (3) the records returned from the OEM confirming that the engines delivered have been brought into conformity in accordance with section 3;
 - 2.4.1. keep these records for at least 10 years;
 - 2.4.2. Make the records available to the approval authority, the European Commission or market surveillance authorities upon request.
 - 2.5. Ensure that, in addition to the statutory marking required by Article 32 of Regulation (EU) 2016/1628, a temporary marking is affixed to the engine without exhaust after-treatment system, as required by Article 33(1) of that Regulation and in accordance with the provisions set out Annex III to Implementing Regulation (EU) 2017/656.
 - 2.6. Ensure that the parts shipped separately from the engines have identification marking (for example part numbers).
 - 2.7. Ensure that in the case of a transition engine, the engine (inclusive of the exhaust after-treatment system) has an engine production date prior to the date for placing on the market of engines set out in Annex III to Regulation (EU) 2016/1628, as required by Article 3(7), Article 3(30) and Article 3(32) of that Regulation.
 - 2.7.1. The records set out in point 2.4 shall include evidence that the exhaust after-treatment system that is part of a transition engine was produced prior to the said date in the case that the production date is not apparent from the marking on the exhaust after-treatment system.

▼B

3. The OEM shall:

- 3.1. Confirm to the manufacturer that the engine has been brought into conformity with the approved engine type or engine family according to the instructions received and that all checks necessary to ensure the proper functioning of the assembled engine according to the approved engine type have been conducted.
- 3.2. Where an OEM receives a regular supply of engines from a manufacturer the confirmation set out in point 3.1 may be provided at regular intervals agreed between the parties, but not exceeding one year.

*ANNEX XI***Detailed technical specifications and conditions for the temporary placing on the market for the purposes of field testing**

The following conditions shall apply for the temporary placing on the market of engines for the purpose of field testing in accordance with Article 34(4) of Regulation (EU) 2016/1628:

1. The ownership of the engine shall remain with the manufacturer until the procedure set out in point 5 is completed. This does not preclude a financial arrangement with the OEM or end-users who participate in the test procedure.
2. Before placing the engine on the market, the manufacturer shall inform the approval authority of a Member State, indicating his name or trade mark, the unique engine identification number of the engine, the production date of the engine, any relevant information on the emission performance of the engine and the OEM or end-users who participates in the test procedure.
3. The engine shall be accompanied by a statement of conformity delivered by the manufacturer and complying with the provisions set out in Annex II to Implementing Regulation (EU) 2017/656; the statement of conformity shall indicate, in particular, that it is a field testing engine temporarily placed on the market in accordance with Article 34(4) of Regulation (EU) 2016/1628.
4. The engine shall bear the statutory marking set out in Annex III to Implementing Regulation (EU) 2017/656;
5. When the tests have been completed and in any case 24 months from the placing on the market of the engine, the manufacturer shall ensure that the engine is either withdrawn from the market or brought into conformity with Regulation (EU) 2016/1628. The manufacturer shall inform the authorising approval authority of the option taken.
6. Notwithstanding point 5, the manufacturer may apply for an extension of the duration of the test for up to 24 additional months, before the same approval authority providing due justification for the extension request.
 - 6.1. The approval authority may authorise the extension, if deemed justified. In this case:
 - (1) a new statement of conformity shall be issued by the manufacturer for the additional period; and
 - (2) the provisions set out in point 5 shall apply by the end of the extension period or, in any case, 48 months after placing the engine on the market.

*ANNEX XII***Detailed technical specifications and conditions for special purpose engines**

The following conditions shall apply for placing on the market of engines that meet the gaseous and particulate pollutant emission limit values for special purpose engines set out in Annex VI to Regulation (EU) 2016/1628:

1. Before placing the engine on the market, the manufacturer shall take reasonable measures to ensure that the engine will be installed in a non-road mobile machinery to be exclusively used in potentially explosive atmospheres, in accordance with Article 34(5) of that Regulation, or for the launch and recovery of lifeboats operated by a national rescue service, in accordance with Article 34(6) of that Regulation.
2. For the purposes of point 1, a written statement from the OEM or economic operator receiving the engine confirming that it will be installed in a non-road mobile machinery to be exclusively used for such special purposes, shall be considered a reasonable measure.
3. The manufacturer shall:
 - (1) keep the written statement set out in point 2 for at least 10 years; and
 - (2) make it available to the approval authority, the European Commission or market surveillance authorities upon request.
4. The engine shall be accompanied by a statement of conformity delivered by the manufacturer and complying with the provisions set out in Annex II to Implementing Regulation (EU) 2017/656; the statement of conformity shall indicate, in particular, that it is a special purpose engine placed on the market under the conditions set out in Article 34(5) or 34(6) of Regulation (EU) 2016/1628.
5. The engine shall bear the statutory marking set out in Annex III to Implementing Regulation (EU) 2017/656.

▼ B*ANNEX XIII***Acceptance of equivalent engine type-approvals**

1. For engine families or engines types of category NRE the following type-approvals and, where applicable, the corresponding statutory marking, shall be recognised as equivalent to EU type-approvals granted and statutory marking required in accordance with Regulation (EU) 2016/1628:

▼ M2

- (1) EU type-approvals granted on the basis of Regulation (EC) No 595/2009 of the European Parliament and of the Council⁽¹⁾ and its implementing measures, where a technical service confirms that the engine type meets:

▼ B

- (a) the requirements set out in Appendix 2 of Annex IV, when the engine is exclusively intended for use in the place of Stage V engines of categories IWP and IWA, in accordance with Article 4(1), point (1)(b) of Regulation (EU) 2016/1628, or
- (b) the requirements set out in Appendix 1 of Annex IV for engines not covered by paragraph (a);

▼ M2

- (2) type-approvals in conformity with UNECE Regulation No 49.06 series of amendments⁽²⁾, where a technical service confirms that the engine type meets:

▼ B

- (a) the requirements set out in Appendix 2 of Annex IV, when the engine is exclusively intended for use in the place of Stage V engines of categories IWP and IWA, in accordance with Article 4(1), point (1)(b) of Regulation (EU) 2016/1628, or
- (b) the requirements set out in Appendix 1 of Annex IV for engines not covered by paragraph (a).

⁽¹⁾ Regulation (EC) No 595/2009 of the European Parliament and of the Council of 18 June 2009 on type-approval of motor vehicles and engines with respect to emissions from heavy duty vehicles (Euro VI) and on access to vehicle repair and maintenance information and amending Regulation (EC) No 715/2007 and Directive 2007/46/EC and repealing Directives 80/1269/EEC, 2005/55/EC and 2005/78/EC (OJ L 188, 18.7.2009, p. 1.)

⁽²⁾ Regulation No 49 of the Economic Commission for Europe of the United Nations (UN/ECE) — Uniform provisions concerning the measures to be taken against the emission of gaseous and particulate pollutants from compression-ignition engines and positive ignition engines for use in vehicles (OJ L 171, 24.6.2013, p. 1.

*ANNEX XIV***Details of the relevant information and instructions for OEMs**

1. As required by Article 43(2) of Regulation (EU) 2016/1628, the manufacturer shall provide to the OEM all relevant information and instructions to ensure that the engine conforms to the approved engine type when installed in non-road mobile machinery. Instructions for this purpose shall be clearly identified to the OEM.
2. The instructions may be provided on paper or a commonly used electronic format.
3. Where a number of engines requiring the same instructions are supplied to the same OEM it shall be necessary to provide only one set of instructions.
4. The information and instructions to the OEM shall include at least:
 - (1) installation requirements to achieve the emissions performance of the engine type, including the emissions control system, that shall be taken into account to ensure the correct operation of the emissions control system;
 - (2) a description of any special conditions or restrictions linked to the installation or use of the engine, as noted on the EU type-approval certificate set out in Annex IV to Implementing Regulation (EU) 2017/656;
 - (3) a statement indicating that the installation of the engine shall not permanently constrain the engine to exclusively operate within a power range corresponding to a (sub-)category with gaseous and particulate pollutant emission limits more stringent than the (sub-)category the engine belongs to;
 - (4) for engine families to which Annex V applies, the upper and lower boundaries of the applicable control area and a statement indicating that the installation of the engine shall not constrain the engine to exclusively operate at speed and load points outside of the control area for the torque curve of the engine;
 - (5) where applicable, design requirements for the components supplied by the OEM that are not part of the engine and are necessary to ensure that, when installed, the engine conforms to the approved engine type;
 - (6) where applicable, design requirements for the reagent tank, including freeze protection, monitoring of reagent level and means to take samples of reagent;
 - (7) where applicable, information on the possible installation of a non-heated reagent system;
 - (8) where applicable, a statement indicating that the engine is exclusively intended for installation in snow throwers;
 - (9) where applicable, a statement indicating that the OEM shall provide a warning system as set out in Appendices 1 to 4 of Annex IV;
 - (10) where applicable, information on the interface between the engine and the non-road mobile machinery for the operator warning system, referred to in point (9);

▼B

- (11) where applicable, information on the interface between the engine and the non-road mobile machinery for the operator inducement system, as set out in section 5 of Appendix 1 of Annex IV;
 - (12) where applicable, information on a means to temporarily disable the operator inducement as defined in point 5.2.1 of Appendix 1 of Annex IV;
 - (13) where applicable, information on the inducement override function as defined in point 5.5 of Appendix 1 of Annex IV;
 - (14) in the case of dual-fuel engines:
 - (a) a statement indicating that the OEM shall provide a dual-fuel operating mode indicator as described in point 4.3.1 of Annex VIII,
 - (b) a statement indicating that the OEM shall provide a dual-fuel warning system as described in point 4.3.2 of Annex VIII,
 - (c) information on the interface between the engine and the non-road mobile machinery for the operator indication and warning system, referred to in points (14)(a) and (b);
 - (15) in the case of a variable speed engine of category IWP that is type-approved for use in one or more other inland waterway application as set out in point 1.1.1.2 of Annex IX to Implementing Regulation (EU) 2017/656, the details of each (sub-)category and operating mode (speed operation) for which the engine is type approved and may be set when installed;
 - (16) In the case of a constant-speed engine equipped with alternative speeds as set out in section 1.1.2.3 of Annex IX to Implementing Regulation (EU) 2017/656:
 - (a) a statement indicating that the installation of the engine shall ensure that:
 - (i) the engine is stopped prior to resetting the constant-speed governor to an alternative speed; and,
 - (ii) the constant-speed governor is only set to the alternative speeds permitted by the engine manufacturer;
 - (b) details of each (sub-)category and operating mode (speed operation) for which the engine is type-approved and may be set when installed;
 - (17) In the case that the engine is equipped with an idle speed for start-up and shut-down, as permitted by Article 3 (18) of Regulation (EU) 2016/1628, a statement indicating that the installation of the engine shall ensure that the constant-speed governor function is engaged prior to increasing the load-demand to the engine from the no-load setting.
5. As required by Article 43(3) of Regulation (EU) 2016/1628, the manufacturer shall provide to the OEM all information and necessary instructions that the OEM shall provide to the end-users in accordance with Annex XV.

▼B

6. As required by Article 43(4) of Regulation (EU) 2016/1628, the manufacturer shall provide to the OEM the value of the carbon dioxide (CO₂) emissions in g/kWh determined during the EU type-approval process and recorded in EU type-approval certificate. This value shall be provided by the OEM to the end-users accompanied of the following statement: *‘This CO₂ measurement results from testing over a fixed test cycle under laboratory conditions a(n) (parent) engine representative of the engine type (engine family) and shall not imply or express any guarantee of the performance of a particular engine’*.

*ANNEX XV***Details of the relevant information and instructions for end-users**

1. The OEM shall provide to the end-users all information and necessary instructions for the correct operation of the engine in order to maintain the gaseous and particulate pollutant emissions of the engine within the limits of the approved engine type or engine family. Instructions for this purpose shall be clearly identified to the end-users.
2. The instructions to the end-users shall be:
 - 2.1. written in a clear and non-technical manner using the same language that is used in the instructions to end-users for the non-road mobile machinery;
 - 2.2. be provided on paper or, alternatively, a commonly used electronic format;
 - 2.3. be part of the instructions to end-users for the non-road machinery or, alternatively, a separate document;
 - 2.3.1. when delivered separately from the instructions to end-users for the non-road machinery, be provided in the same form;
3. The information and instructions to the end-users shall include at least:
 - (1) a description of any special conditions or restrictions linked to the use of the engine, as noted on the EU type-approval certificate set out in Annex IV to Implementing Regulation (EU) 2017/656;
 - (2) a statement indicating that the engine, including the emissions control system, shall be operated, used and maintained in accordance with the instructions provided to the end-users in order to maintain the emissions performance of the engine within the requirements applicable to the engine's category;
 - (3) a statement indicating that no deliberate tampering with or misuse of the engine emissions control system should take place; in particular with regard to deactivating or not maintaining an exhaust gas recirculation (EGR) or a reagent dosing system.
 - (4) a statement indicating that it is essential to take prompt action to rectify any incorrect operation, use or maintenance of the emissions control system in accordance with the rectification measures indicated by the warnings referred to in points (5) and (6);
 - (5) detailed explanations of the possible malfunctions of the emissions control system generated by incorrect operation, use or maintenance of the installed engine, accompanied by the associated warning signals and the corresponding rectification measures;
 - (6) detailed explanations of the possible incorrect use of the non-road mobile machinery that would result in malfunctions of the engine emissions control system, accompanied by the associated warning signals and the corresponding rectification measures;
 - (7) where applicable, information on the possible use of a non-heated reagent tank and dosing system;

▼B

- (8) where applicable, a statement indicating that the engine is exclusively intended for use in snow throwers;
- (9) for non-road mobile machinery with an operator warning system, as defined in section 4 Appendix 1 of Annex IV (category: NRE, NRG, IWP, IWA or RLR) and/or section 4 of Appendix 4 of Annex IV (category: NRE, NRG, IWP, IWA or RLR) or section 3 of Appendix 3 of Annex IV (category RLL), a statement indicating that the operator will be informed by the operator warning system when the emission control system does not function correctly;
- (10) for non-road mobile machinery with an operator inducement system as defined in section 5 of Appendix 1 of Annex IV (category NRE, NRG), a statement indicating that ignoring the operator warning signals will lead to the activation of the operator inducement system, resulting in an effective disablement of non-road mobile machinery operation;
- (11) for non-road mobile machinery with an inducement override function as defined in point 5.5 of Appendix 1 of Annex IV for releasing full engine power, information about the operation of this function;
- (12) where applicable, explanations of how the operator warning and inducement systems referred to in points (9), (10) and (11) operate, including the consequences, in terms of performance and fault logging, of ignoring the warning system signals and of not replenishing, where used, the reagent or rectifying the problem identified;
- (13) where records in the on-board computer log of inadequate reagent injection or reagent quality are made in accordance with point 4.1 of Appendix 2 of Annex IV (category: IWP, IWA, RLR), an statement indicating that national inspection authorities will be able to read with a scan tool these records;
- (14) for non-road mobile machinery with a means to disable the operator inducement as defined in point 5.2.1 of Appendix 1 of Annex IV, information about the operation of this function, and a statement indicating that this function shall be only activated in case of emergencies, that any activation will be recorded in the on-board computer log and that national inspection authorities will be able to read these records with a scan tool;
- (15) information on the fuel specification(s) necessary to maintain the performance of the emissions control system following the requirements of Annex I and in consistency with the specifications set-out in the engine EU type-approval including, where available, reference to the appropriate EU or international standard, in particular:

▼M2

- (a) where the engine is to be operated within the Union on diesel or non-road gas-oil, a statement indicating that a fuel with sulphur content not greater than 10 mg/kg (20 mg/kg at point of final distribution) cetane number not less than 45 and a FAME content not greater than 8 % v/v shall be used.

▼B

- (b) where additional fuels, fuel mixtures or fuel emulsions are compatible with use by the engine, as declared by the manufacturer and stated in the EU type-approval certificate, these shall be indicated;

▼B

- (16) information on the lubrication oil specifications necessary to maintain the performance of the emissions control system;
 - (17) where the emission control system requires a reagent, the characteristics of that reagent, including the type of reagent, information on concentration when the reagent is in solution, operational temperature conditions and reference to international standards for composition and quality, consistent with the specification set-out in the engine EU type-approval.
 - (18) where applicable, instructions specifying how consumable reagents have to be refilled by the operator between normal maintenance intervals. They shall indicate how the operator should refill the reagent tank and the anticipated frequency of refill, depending upon utilisation of the non-road mobile machinery.
 - (19) a statement indicating that in order to maintain the emissions performance of the engine, it is essential to use and refill reagent in accordance with the specifications set out in points (17) and (18);
 - (20) scheduled emission-related maintenance requirements including any scheduled exchange of critical emission-related components;
 - (21) in the case of dual fuel engines:
 - (a) where applicable, information on the dual-fuel indicators set out in section 4.3 of Annex VIII,
 - (b) where a dual fuel engine has operability restrictions in a service mode as defined in point 4.2.2.1 of Annex VIII (excluding categories: IWP, IWA, RLL and RLR), a statement indicating that the activation of the service mode will result in an effective disablement of non-road mobile machinery operation,
 - (c) where an inducement override function for releasing full engine power is available, information about the operation of this function shall be provided,
 - (d) where a dual fuel engine operates in a service mode in accordance with point 4.2.2.2 of Annex VIII (categories: IWP, IWA, RLL and RLR), a statement indicating that the activation of the service mode will be recorded in the on-board computer log and that national inspection authorities will be able to read these records with a scan tool.
4. As required by Article 43(4) of Regulation (EU) 2016/1628, the OEM shall provide to the end-users the value of the carbon dioxide (CO₂) emissions in g/kWh determined during the EU type-approval process and recorded in EU type-approval certificate accompanied of the following statement: *'This CO₂ measurement results from testing over a fixed test cycle under laboratory conditions a(n) (parent) engine representative of the engine type (engine family) and shall not imply or express any guarantee of the performance of a particular engine'*.

*ANNEX XVI***Performance standards and assessment of technical services****1. General Requirements**

Technical services shall demonstrate appropriate skills, specific technical knowledge and proven experience in the specific fields of competence covered by Regulation (EU) 2016/1628 and the delegated and implementing acts adopted pursuant to that Regulation.

2. Standards with which the technical services have to comply

- 2.1. Technical services of the different categories set out in Article 45 of Regulation (EU) 2016/1628 shall comply with the standards listed in Appendix 1 of Annex V to Directive 2007/46/EC of the European Parliament and of the Council ⁽¹⁾ which are relevant for the activities they carry out.
- 2.2. Reference to Article 41 of Directive 2007/46/EC in that Appendix shall be construed as a reference to Article 45 of Regulation (EU) 2016/1628.
- 2.3. Reference to Annex IV of Directive 2007/46/EC in that Appendix shall be construed as a reference to Regulation (EU) 2016/1628 and the delegated and implementing acts adopted pursuant to that Regulation.

3. Procedure for the assessment of the technical services

- 3.1. The compliance of the Technical services with the requirements of Regulation (EU) 2016/1628 and the delegated and implementing acts adopted pursuant to that Regulation shall be assessed in accordance with the procedure set out in Appendix 2 of Annex V to Directive 2007/46/EC.
- 3.2. References to Article 42 of Directive 2007/46/EC in Appendix 2 of Annex V to Directive 2007/46/EC shall be construed as references to Article 48 of Regulation (EU) 2016/1628.

⁽¹⁾ Directive 2007/46/EC of the European Parliament and of the Council of 5 September 2007 establishing a framework for the approval of motor vehicles and their trailers, and of systems, components and separate technical units intended for such vehicles (OJ L 263, 9.10.2007, p. 1).

▼B*ANNEX XVII***Characteristics of the steady-state and transient test cycles**

1. Tables of test modes and weighting factors for the discrete-mode NRSC are set out in Appendix 1.
2. Tables of test modes and weighting factors for the RMC are set out in Appendix 2.
3. Tables of engine dynamometer schedules for transient (NRTC and LSI-NRTC) test cycles are set out in Appendix 3.



Appendix 1

Steady-state discrete-mode NRSC

Test cycles type C

Table of cycle C1 test modes and weighting factors

Mode number	1	2	3	4	5	6	7	8
Speed ^(a)	100 %				Intermediate			Idle
Torque ^(b) (%)	100	75	50	10	100	75	50	0
Weighting factor	0,15	0,15	0,15	0,1	0,1	0,1	0,1	0,15

^(a) See sections 5.2.5, 7.6 and 7.7 of Annex VI for determination of required test speeds.

^(b) The % torque is relative to the maximum torque at the commanded engine speed.

Table of cycle C2 test modes and weighting factors

Mode number	1	2	3	4	5	6	7
Speed ^(a)	100 %	Intermediate					Idle
Torque ^(b) (%)	25	100	75	50	25	10	0
Weighting factor	0,06	0,02	0,05	0,32	0,30	0,10	0,15

^(a) See sections 5.2.5, 7.6 and 7.7 of Annex VI for determination of required test speeds.

^(b) The % torque is relative to the maximum torque at the commanded engine speed.

Test cycles type D

Table of cycle D2 test modes and weighting factors

Mode number (cycle D2)	1	2	3	4	5
Speed ^(a)	100 %				
Torque ^(b) (%)	100	75	50	25	10
Weighting factor	0,05	0,25	0,3	0,3	0,1

^(a) See sections 5.2.5, 7.6 and 7.7 of Annex VI for determination of required test speeds.

^(b) % torque is relative to the torque corresponding to the rated net power declared by the manufacturer.

Test cycles type E

Table of cycles type E test modes and weighting factors

Mode number (cycle E2)	1	2	3	4						
Speed ^(a)	100 %				Intermediate					
Torque ^(b) (%)	100	75	50	25						
Weighting factor	0,2	0,5	0,15	0,15						

▼B

Mode number (cycle E3)	1	2	3	4
Speed ^(a) (%)	100	91	80	63
Power ^(c) (%)	100	75	50	25
Weighting factor	0,2	0,5	0,15	0,15

^(a) See sections 5.2.5, 7.6 and 7.7 of Annex VI for determination of required test speeds.

^(b) % torque is relative to the torque corresponding to the rated net power declared by the manufacturer at the commanded engine speed.

^(c) % power is relative to the maximum rated power at the 100 % speed.

Test cycle type F**Table of cycle type F test modes and weighting factors**

Mode number	1	2 ^(d)	3
Speed ^(a)	100 %	Intermediate	Idle
Power (%)	100 ^(c)	50 ^(c)	5 ^(b)
Weighting factor	0,15	0,25	0,6

^(a) See sections 5.2.5, 7.6 and 7.7 of Annex VI for determination of required test speeds.

^(b) % power at this mode is relative to the power at mode 1.

^(c) % power at this mode is relative to the maximum net power at the commanded engine speed.

^(d) For engines using a discrete control system (i.e. notch type controls) mode 2 is defined as an operation in the notch closest to mode 2 or 35 % of the rated power.

Test cycle type G**Table of cycles type G test modes and weighting factors**

Mode number (cycle G1)						1	2	3	4	5	6
Speed ^(a)	100 %					Intermediate					Idle
Torque ^(b) %						100	75	50	25	10	0
Weighting factor						0,09	0,20	0,29	0,30	0,07	0,05
Mode number (cycle G2)	1	2	3	4	5						6
Speed ^(a)	100 %					Intermediate					Idle
Torque ^(b) %	100	75	50	25	10						0
Weighting factor	0,09	0,20	0,29	0,30	0,07						0,05
Mode number (cycle G3)	1										2
Speed ^(a)	100 %					Intermediate					Idle
Torque ^(b) %	100										0
Weighting factor	0,85										0,15

^(a) See sections 5.2.5, 7.6 and 7.7 of Annex VI for determination of required test speeds.

^(b) The % torque is relative to the maximum torque at the commanded engine speed.

▼B**Test cycle type H****Table of cycle type H test modes and weighting factors**

Mode number	1	2	3	4	5
Speed ^(a) (%)	100	85	75	65	Idle
Torque ^(b) (%)	100	51	33	19	0
Weighting factor	0,12	0,27	0,25	0,31	0,05

^(a) See sections 5.2.5, 7.6 and 7.7 of Annex VI for determination of required test speeds.

^(b) % torque is relative to the maximum torque at the commanded engine speed.



Appendix 2

Steady-state ramped modal cycles (RMC)

Test cycles type C

Table of RMC-C1 test modes

RMC Mode Number	Time in mode (seconds)	Engine speed ^(a) ^(c)	Torque (%) ^(b) ^(c)
1a Steady-state	126	Idle	0
1b Transition	20	Linear transition	Linear transition
2a Steady-state	159	Intermediate	100
2b Transition	20	Intermediate	Linear transition
3a Steady-state	160	Intermediate	50
3b Transition	20	Intermediate	Linear transition
4a Steady-state	162	Intermediate	75
4b Transition	20	Linear transition	Linear transition
5a Steady-state	246	100 %	100
5b Transition	20	100 %	Linear transition
6a Steady-state	164	100 %	10
6b Transition	20	100 %	Linear transition
7a Steady-state	248	100 %	75
7b Transition	20	100 %	Linear transition
8a Steady-state	247	100 %	50
8b Transition	20	Linear transition	Linear transition
9 Steady-state	128	Idle	0

^(a) See sections 5.2.5, 7.6 and 7.7 of Annex VI for determination of required test speeds.

^(b) % torque is relative to the maximum torque at the commanded engine speed.

^(c) Advance from one mode to the next within a 20-second transition phase. During the transition phase, command a linear progression from the torque setting of the current mode to the torque setting of the next mode, and simultaneously command a similar linear progression for engine speed if there is a change in speed setting.

Table of RMC-C2 test modes

RMC Mode number	Time in mode (seconds)	Engine speed ^(a) ^(c)	Torque (%) ^(b) ^(c)
1a Steady-state	119	Idle	0
1b Transition	20	Linear transition	Linear transition
2a Steady-state	29	Intermediate	100

▼B

RMC Mode number	Time in mode (seconds)	Engine speed ^(a) ^(c)	Torque (%) ^(b) ^(c)
2b Transition	20	Intermediate	Linear transition
3a Steady-state	150	Intermediate	10
3b Transition	20	Intermediate	Linear transition
4a Steady-state	80	Intermediate	75
4b Transition	20	Intermediate	Linear transition
5a Steady-state	513	Intermediate	25
5b Transition	20	Intermediate	Linear transition
6a Steady-state	549	Intermediate	50
6b Transition	20	Linear transition	Linear transition
7a Steady-state	96	100 %	25
7b Transition	20	Linear transition	Linear transition
8 Steady-state	124	Idle	0

^(a) See sections 5.2.5, 7.6 and 7.7 of Annex VI for determination of required test speeds.

^(b) % torque is relative to the maximum torque at the commanded engine speed.

^(c) Advance from one mode to the next within a 20-second transition phase. During the transition phase, command a linear progression from the torque setting of the current mode to the torque setting of the next mode, and simultaneously command a similar linear progression for engine speed if there is a change in speed setting.

Test cycles type D**Table of RMC-D2 test modes**

RMC Mode Number	Time in mode (seconds)	Engine speed (%) ^(a)	Torque (%) ^(b) ^(c)
1a Steady State	53	100	100
1b Transition	20	100	Linear transition
2a Steady-state	101	100	10
2b Transition	20	100	Linear transition
3a Steady-state	277	100	75
3b Transition	20	100	Linear transition
4a Steady-state	339	100	25
4b Transition	20	100	Linear transition
5 Steady-state	350	100	50

^(a) See sections 5.2.5, 7.6 and 7.7 of Annex VI for determination of required test speeds.

^(b) % torque is relative to the torque corresponding to the rated net power declared by the manufacturer.

^(c) Advance from one mode to the next within a 20-second transition phase. During the transition phase, command a linear progression from the torque setting of the current mode to the torque setting of the next mode.

▼B**Test cycles type E****Table of RMC-E2 test modes**

RMC Mode Number	Time in mode (seconds)	Engine speed (%) ^(a)	Torque (%) ^(b) ^(c)
1a Steady-state	229	100	100
1b Transition	20	100	Linear transition
2a Steady-state	166	100	25
2b Transition	20	100	Linear transition
3a Steady-state	570	100	75
3b Transition	20	100	Linear transition
4 Steady-state	175	100	50

^(a) See sections 5.2.5, 7.6 and 7.7 of Annex VI for determination of required test speeds.

^(b) % torque is relative to the maximum torque corresponding to the rated net power declared by the manufacturer at the commanded engine speed.

^(c) Advance from one mode to the next within a 20-second transition phase. During the transition phase, command a linear progression from the torque setting of the current mode to the torque setting of the next mode.

Table of RMC-E3 test modes

RMC Mode Number	Time in mode (seconds)	Engine speed (%) ^(a) ^(c)	Power (%) ^(b) ^(c)
1a Steady-state	229	100	100
1b Transition	20	Linear transition	Linear transition
2a Steady-state	166	63	25
2b Transition	20	Linear transition	Linear transition
3a Steady-state	570	91	75
3b Transition	20	Linear transition	Linear transition
4 Steady-state	175	80	50

^(a) See sections 5.2.5, 7.6 and 7.7 of Annex VI for determination of required test speeds.

^(b) % power is relative to the maximum rated net power at the 100 % speed.

^(c) Advance from one mode to the next within a 20-second transition phase. During the transition phase, command a linear progression from the torque setting of the current mode to the torque setting of the next mode, and simultaneously command a similar linear progression for engine speed.

Test cycle type F**Table of RMC-F test modes**

RMC Mode Number	Time in mode (seconds)	Engine speed ^(a) ^(c)	Power (%) ^(c)
1a Steady-state	350	Idle	5 ^(b)
1b Transition	20	Linear transition	Linear transition
2a Steady-state ^(d)	280	Intermediate	50 ^(c)

▼B

RMC Mode Number	Time in mode (seconds)	Engine speed ^(a) ^(e)	Power (%) ^(e)
2b Transition	20	Linear transition	Linear transition
3a Steady-state	160	100 %	100 ^(e)
3b Transition	20	Linear Transition	Linear transition
4 Steady-state	350	Idle	5 ^(e)

^(a) See sections 5.2.5, 7.6 and 7.7 of Annex VI for determination of required test speeds.

^(b) % power at this mode is relative to the net power at mode 3a.

^(c) % power at this mode is relative to the maximum net power at the commanded engine speed.

^(d) For engines using a discrete control system (i.e. notch type controls) mode 2a is defined as an operation in the notch closest to mode 2a or 35 % of the rated power.

^(e) Advance from one mode to the next within a 20-second transition phase. During the transition phase, command a linear progression from the torque setting of the current mode to the torque setting of the next mode, and simultaneously command a similar linear progression for engine speed if there is a change in speed setting.

Test cycles type G**Table of RMC-G1 test modes**

RMC Mode Number	Time in mode (seconds)	Engine speed ^(a) ^(e)	Torque (%) ^(b) ^(e)
1a Steady-state	41	Idle	0
1b Transition	20	Linear transition	Linear transition
2a Steady-state	135	Intermediate	100
2b Transition	20	Intermediate	Linear transition
3a Steady-state	112	Intermediate	10
3b Transition	20	Intermediate	Linear transition
4a Steady-state	337	Intermediate	75
4b Transition	20	Intermediate	Linear transition
5a Steady-state	518	Intermediate	25
5b Transition	20	Intermediate	Linear transition
6a Steady-state	494	Intermediate	50
6b Transition	20	Linear transition	Linear transition
7 Steady-state	43	Idle	0

^(a) See sections 5.2.5, 7.6 and 7.7 of Annex VI for determination of required test speeds.

^(b) The % torque is relative to the maximum torque at the commanded engine speed.

^(c) Advance from one mode to the next within a 20-second transition phase. During the transition phase, command a linear progression from the torque setting of the current mode to the torque setting of the next mode and simultaneously command a similar linear progression for engine speed if there is a change in speed setting.

**Table of RMC-G2 test modes**

RMC Mode Number	Time in mode (seconds)	Engine speed ^(a) ^(c)	Torque (%) ^(b) ^(c)
1a Steady-state	41	Idle	0
1b Transition	20	Linear transition	Linear transition
2a Steady-state	135	100 %	100
2b Transition	20	100 %	Linear transition
3a Steady-state	112	100 %	10
3b Transition	20	100 %	Linear transition
4a Steady-state	337	100 %	75
4b Transition	20	100 %	Linear transition
5a Steady-state	518	100 %	25
5b Transition	20	100 %	Linear transition
6a Steady-state	494	100 %	50
6b Transition	20	Linear transition	Linear transition
7 Steady-state	43	Idle	0

^(a) See sections 5.2.5, 7.6 and 7.7 of Annex VI for determination of required test speeds.

^(b) The % torque is relative to the maximum torque at the commanded engine speed.

^(c) Advance from one mode to the next within a 20-second transition phase. During the transition phase, command a linear progression from the torque setting of the current mode to the torque setting of the next mode and simultaneously command a similar linear progression for engine speed if there is a change in speed setting.

Test cycle type H**Table of RMC-H test modes**

RMC Mode Number	Time in mode (seconds)	Engine speed ^(a) ^(c)	Torque (%) ^(b) ^(c)
1a Steady-state	27	Idle	0
1b Transition	20	Linear transition	Linear transition
2a Steady-state	121	100 %	100
2b Transition	20	Linear transition	Linear transition
3a Steady-state	347	65 %	19
3b Transition	20	Linear transition	Linear transition
4a Steady-state	305	85 %	51
4b Transition	20	Linear transition	Linear transition
5a Steady-state	272	75 %	33
5b Transition	20	Linear transition	Linear transition
6 Steady-state	28	Idle	0

^(a) See sections 5.2.5, 7.6 and 7.7 of Annex VI for determination of required test speeds.

^(b) % torque is relative to the maximum torque at the commanded engine speed.

^(c) Advance from one mode to the next within a 20-second transition phase. During the transition phase, command a linear progression from the torque setting of the current mode to the torque setting of the next mode, and simultaneously command a similar linear progression for engine speed if there is a change in speed setting.



Appendix 3

2.4.2.1 Transient (NRTC and LSI-NRTC) test cycles

NRTC engine dynamometer schedule

Time (s)	Normalized speed (%)	Normalized torque (%)	Time (s)	Normalized speed (%)	Normalized torque (%)	Time (s)	Normalized speed (%)	Normalized torque (%)
1	0	0	37	33	42	73	62	24
2	0	0	38	57	46	74	64	8
3	0	0	39	44	33	75	58	44
4	0	0	40	31	0	76	65	10
5	0	0	41	22	27	77	65	12
6	0	0	42	33	43	78	68	23
7	0	0	43	80	49	79	69	30
8	0	0	44	105	47	80	71	30
9	0	0	45	98	70	81	74	15
10	0	0	46	104	36	82	71	23
11	0	0	47	104	65	83	73	20
12	0	0	48	96	71	84	73	21
13	0	0	49	101	62	85	73	19
14	0	0	50	102	51	86	70	33
15	0	0	51	102	50	87	70	34
16	0	0	52	102	46	88	65	47
17	0	0	53	102	41	89	66	47
18	0	0	54	102	31	90	64	53
19	0	0	55	89	2	91	65	45
20	0	0	56	82	0	92	66	38
21	0	0	57	47	1	93	67	49
22	0	0	58	23	1	94	69	39
23	0	0	59	1	3	95	69	39
24	1	3	60	1	8	96	66	42
25	1	3	61	1	3	97	71	29
26	1	3	62	1	5	98	75	29
27	1	3	63	1	6	99	72	23
28	1	3	64	1	4	100	74	22
29	1	3	65	1	4	101	75	24
30	1	6	66	0	6	102	73	30
31	1	6	67	1	4	103	74	24
32	2	1	68	9	21	104	77	6
33	4	13	69	25	56	105	76	12
34	7	18	70	64	26	106	74	39
35	9	21	71	60	31	107	72	30
36	17	20	72	63	20	108	75	22

▼B

Time (s)	Normalized speed (%)	Normalized torque (%)
109	78	64
110	102	34
111	103	28
112	103	28
113	103	19
114	103	32
115	104	25
116	103	38
117	103	39
118	103	34
119	102	44
120	103	38
121	102	43
122	103	34
123	102	41
124	103	44
125	103	37
126	103	27
127	104	13
128	104	30
129	104	19
130	103	28
131	104	40
132	104	32
133	101	63
134	102	54
135	102	52
136	102	51
137	103	40
138	104	34
139	102	36
140	104	44
141	103	44
142	104	33
143	102	27
144	103	26
145	79	53
146	51	37
147	24	23
148	13	33

Time (s)	Normalized speed (%)	Normalized torque (%)
149	19	55
150	45	30
151	34	7
152	14	4
153	8	16
154	15	6
155	39	47
156	39	4
157	35	26
158	27	38
159	43	40
160	14	23
161	10	10
162	15	33
163	35	72
164	60	39
165	55	31
166	47	30
167	16	7
168	0	6
169	0	8
170	0	8
171	0	2
172	2	17
173	10	28
174	28	31
175	33	30
176	36	0
177	19	10
178	1	18
179	0	16
180	1	3
181	1	4
182	1	5
183	1	6
184	1	5
185	1	3
186	1	4
187	1	4
188	1	6

Time (s)	Normalized speed (%)	Normalized torque (%)
189	8	18
190	20	51
191	49	19
192	41	13
193	31	16
194	28	21
195	21	17
196	31	21
197	21	8
198	0	14
199	0	12
200	3	8
201	3	22
202	12	20
203	14	20
204	16	17
205	20	18
206	27	34
207	32	33
208	41	31
209	43	31
210	37	33
211	26	18
212	18	29
213	14	51
214	13	11
215	12	9
216	15	33
217	20	25
218	25	17
219	31	29
220	36	66
221	66	40
222	50	13
223	16	24
224	26	50
225	64	23
226	81	20
227	83	11
228	79	23

▼B

Time (s)	Normalized speed (%)	Normalized torque (%)
229	76	31
230	68	24
231	59	33
232	59	3
233	25	7
234	21	10
235	20	19
236	4	10
237	5	7
238	4	5
239	4	6
240	4	6
241	4	5
242	7	5
243	16	28
244	28	25
245	52	53
246	50	8
247	26	40
248	48	29
249	54	39
250	60	42
251	48	18
252	54	51
253	88	90
254	103	84
255	103	85
256	102	84
257	58	66
258	64	97
259	56	80
260	51	67
261	52	96
262	63	62
263	71	6
264	33	16
265	47	45
266	43	56
267	42	27
268	42	64

Time (s)	Normalized speed (%)	Normalized torque (%)
269	75	74
270	68	96
271	86	61
272	66	0
273	37	0
274	45	37
275	68	96
276	80	97
277	92	96
278	90	97
279	82	96
280	94	81
281	90	85
282	96	65
283	70	96
284	55	95
285	70	96
286	79	96
287	81	71
288	71	60
289	92	65
290	82	63
291	61	47
292	52	37
293	24	0
294	20	7
295	39	48
296	39	54
297	63	58
298	53	31
299	51	24
300	48	40
301	39	0
302	35	18
303	36	16
304	29	17
305	28	21
306	31	15
307	31	10
308	43	19

Time (s)	Normalized speed (%)	Normalized torque (%)
309	49	63
310	78	61
311	78	46
312	66	65
313	78	97
314	84	63
315	57	26
316	36	22
317	20	34
318	19	8
319	9	10
320	5	5
321	7	11
322	15	15
323	12	9
324	13	27
325	15	28
326	16	28
327	16	31
328	15	20
329	17	0
330	20	34
331	21	25
332	20	0
333	23	25
334	30	58
335	63	96
336	83	60
337	61	0
338	26	0
339	29	44
340	68	97
341	80	97
342	88	97
343	99	88
344	102	86
345	100	82
346	74	79
347	57	79
348	76	97

▼B

Time (s)	Normalized speed (%)	Normalized torque (%)
349	84	97
350	86	97
351	81	98
352	83	83
353	65	96
354	93	72
355	63	60
356	72	49
357	56	27
358	29	0
359	18	13
360	25	11
361	28	24
362	34	53
363	65	83
364	80	44
365	77	46
366	76	50
367	45	52
368	61	98
369	61	69
370	63	49
371	32	0
372	10	8
373	17	7
374	16	13
375	11	6
376	9	5
377	9	12
378	12	46
379	15	30
380	26	28
381	13	9
382	16	21
383	24	4
384	36	43
385	65	85
386	78	66
387	63	39
388	32	34

Time (s)	Normalized speed (%)	Normalized torque (%)
389	46	55
390	47	42
391	42	39
392	27	0
393	14	5
394	14	14
395	24	54
396	60	90
397	53	66
398	70	48
399	77	93
400	79	67
401	46	65
402	69	98
403	80	97
404	74	97
405	75	98
406	56	61
407	42	0
408	36	32
409	34	43
410	68	83
411	102	48
412	62	0
413	41	39
414	71	86
415	91	52
416	89	55
417	89	56
418	88	58
419	78	69
420	98	39
421	64	61
422	90	34
423	88	38
424	97	62
425	100	53
426	81	58
427	74	51
428	76	57

Time (s)	Normalized speed (%)	Normalized torque (%)
429	76	72
430	85	72
431	84	60
432	83	72
433	83	72
434	86	72
435	89	72
436	86	72
437	87	72
438	88	72
439	88	71
440	87	72
441	85	71
442	88	72
443	88	72
444	84	72
445	83	73
446	77	73
447	74	73
448	76	72
449	46	77
450	78	62
451	79	35
452	82	38
453	81	41
454	79	37
455	78	35
456	78	38
457	78	46
458	75	49
459	73	50
460	79	58
461	79	71
462	83	44
463	53	48
464	40	48
465	51	75
466	75	72
467	89	67
468	93	60

▼B

Time (s)	Normalized speed (%)	Normalized torque (%)
469	89	73
470	86	73
471	81	73
472	78	73
473	78	73
474	76	73
475	79	73
476	82	73
477	86	73
478	88	72
479	92	71
480	97	54
481	73	43
482	36	64
483	63	31
484	78	1
485	69	27
486	67	28
487	72	9
488	71	9
489	78	36
490	81	56
491	75	53
492	60	45
493	50	37
494	66	41
495	51	61
496	68	47
497	29	42
498	24	73
499	64	71
500	90	71
501	100	61
502	94	73
503	84	73
504	79	73
505	75	72
506	78	73
507	80	73
508	81	73

Time (s)	Normalized speed (%)	Normalized torque (%)
509	81	73
510	83	73
511	85	73
512	84	73
513	85	73
514	86	73
515	85	73
516	85	73
517	85	72
518	85	73
519	83	73
520	79	73
521	78	73
522	81	73
523	82	72
524	94	56
525	66	48
526	35	71
527	51	44
528	60	23
529	64	10
530	63	14
531	70	37
532	76	45
533	78	18
534	76	51
535	75	33
536	81	17
537	76	45
538	76	30
539	80	14
540	71	18
541	71	14
542	71	11
543	65	2
544	31	26
545	24	72
546	64	70
547	77	62
548	80	68

Time (s)	Normalized speed (%)	Normalized torque (%)
549	83	53
550	83	50
551	83	50
552	85	43
553	86	45
554	89	35
555	82	61
556	87	50
557	85	55
558	89	49
559	87	70
560	91	39
561	72	3
562	43	25
563	30	60
564	40	45
565	37	32
566	37	32
567	43	70
568	70	54
569	77	47
570	79	66
571	85	53
572	83	57
573	86	52
574	85	51
575	70	39
576	50	5
577	38	36
578	30	71
579	75	53
580	84	40
581	85	42
582	86	49
583	86	57
584	89	68
585	99	61
586	77	29
587	81	72
588	89	69

▼B

Time (s)	Normalized speed (%)	Normalized torque (%)
589	49	56
590	79	70
591	104	59
592	103	54
593	102	56
594	102	56
595	103	61
596	102	64
597	103	60
598	93	72
599	86	73
600	76	73
601	59	49
602	46	22
603	40	65
604	72	31
605	72	27
606	67	44
607	68	37
608	67	42
609	68	50
610	77	43
611	58	4
612	22	37
613	57	69
614	68	38
615	73	2
616	40	14
617	42	38
618	64	69
619	64	74
620	67	73
621	65	73
622	68	73
623	65	49
624	81	0
625	37	25
626	24	69
627	68	71
628	70	71

Time (s)	Normalized speed (%)	Normalized torque (%)
629	76	70
630	71	72
631	73	69
632	76	70
633	77	72
634	77	72
635	77	72
636	77	70
637	76	71
638	76	71
639	77	71
640	77	71
641	78	70
642	77	70
643	77	71
644	79	72
645	78	70
646	80	70
647	82	71
648	84	71
649	83	71
650	83	73
651	81	70
652	80	71
653	78	71
654	76	70
655	76	70
656	76	71
657	79	71
658	78	71
659	81	70
660	83	72
661	84	71
662	86	71
663	87	71
664	92	72
665	91	72
666	90	71
667	90	71
668	91	71

Time (s)	Normalized speed (%)	Normalized torque (%)
669	90	70
670	90	72
671	91	71
672	90	71
673	90	71
674	92	72
675	93	69
676	90	70
677	93	72
678	91	70
679	89	71
680	91	71
681	90	71
682	90	71
683	92	71
684	91	71
685	93	71
686	93	68
687	98	68
688	98	67
689	100	69
690	99	68
691	100	71
692	99	68
693	100	69
694	102	72
695	101	69
696	100	69
697	102	71
698	102	71
699	102	69
700	102	71
701	102	68
702	100	69
703	102	70
704	102	68
705	102	70
706	102	72
707	102	68
708	102	69

▼B

Time (s)	Normalized speed (%)	Normalized torque (%)
709	100	68
710	102	71
711	101	64
712	102	69
713	102	69
714	101	69
715	102	64
716	102	69
717	102	68
718	102	70
719	102	69
720	102	70
721	102	70
722	102	62
723	104	38
724	104	15
725	102	24
726	102	45
727	102	47
728	104	40
729	101	52
730	103	32
731	102	50
732	103	30
733	103	44
734	102	40
735	103	43
736	103	41
737	102	46
738	103	39
739	102	41
740	103	41
741	102	38
742	103	39
743	102	46
744	104	46
745	103	49
746	102	45
747	103	42
748	103	46

Time (s)	Normalized speed (%)	Normalized torque (%)
749	103	38
750	102	48
751	103	35
752	102	48
753	103	49
754	102	48
755	102	46
756	103	47
757	102	49
758	102	42
759	102	52
760	102	57
761	102	55
762	102	61
763	102	61
764	102	58
765	103	58
766	102	59
767	102	54
768	102	63
769	102	61
770	103	55
771	102	60
772	102	72
773	103	56
774	102	55
775	102	67
776	103	56
777	84	42
778	48	7
779	48	6
780	48	6
781	48	7
782	48	6
783	48	7
784	67	21
785	105	59
786	105	96
787	105	74
788	105	66

Time (s)	Normalized speed (%)	Normalized torque (%)
789	105	62
790	105	66
791	89	41
792	52	5
793	48	5
794	48	7
795	48	5
796	48	6
797	48	4
798	52	6
799	51	5
800	51	6
801	51	6
802	52	5
803	52	5
804	57	44
805	98	90
806	105	94
807	105	100
808	105	98
809	105	95
810	105	96
811	105	92
812	104	97
813	100	85
814	94	74
815	87	62
816	81	50
817	81	46
818	80	39
819	80	32
820	81	28
821	80	26
822	80	23
823	80	23
824	80	20
825	81	19
826	80	18
827	81	17
828	80	20

▼B

Time (s)	Normalized speed (%)	Normalized torque (%)
829	81	24
830	81	21
831	80	26
832	80	24
833	80	23
834	80	22
835	81	21
836	81	24
837	81	24
838	81	22
839	81	22
840	81	21
841	81	31
842	81	27
843	80	26
844	80	26
845	81	25
846	80	21
847	81	20
848	83	21
849	83	15
850	83	12
851	83	9
852	83	8
853	83	7
854	83	6
855	83	6
856	83	6
857	83	6
858	83	6
859	76	5
860	49	8
861	51	7
862	51	20
863	78	52
864	80	38
865	81	33
866	83	29
867	83	22
868	83	16

Time (s)	Normalized speed (%)	Normalized torque (%)
869	83	12
870	83	9
871	83	8
872	83	7
873	83	6
874	83	6
875	83	6
876	83	6
877	83	6
878	59	4
879	50	5
880	51	5
881	51	5
882	51	5
883	50	5
884	50	5
885	50	5
886	50	5
887	50	5
888	51	5
889	51	5
890	51	5
891	63	50
892	81	34
893	81	25
894	81	29
895	81	23
896	80	24
897	81	24
898	81	28
899	81	27
900	81	22
901	81	19
902	81	17
903	81	17
904	81	17
905	81	15
906	80	15
907	80	28
908	81	22

Time (s)	Normalized speed (%)	Normalized torque (%)
909	81	24
910	81	19
911	81	21
912	81	20
913	83	26
914	80	63
915	80	59
916	83	100
917	81	73
918	83	53
919	80	76
920	81	61
921	80	50
922	81	37
923	82	49
924	83	37
925	83	25
926	83	17
927	83	13
928	83	10
929	83	8
930	83	7
931	83	7
932	83	6
933	83	6
934	83	6
935	71	5
936	49	24
937	69	64
938	81	50
939	81	43
940	81	42
941	81	31
942	81	30
943	81	35
944	81	28
945	81	27
946	80	27
947	81	31
948	81	41

▼B

Time (s)	Normalized speed (%)	Normalized torque (%)
949	81	41
950	81	37
951	81	43
952	81	34
953	81	31
954	81	26
955	81	23
956	81	27
957	81	38
958	81	40
959	81	39
960	81	27
961	81	33
962	80	28
963	81	34
964	83	72
965	81	49
966	81	51
967	80	55
968	81	48
969	81	36
970	81	39
971	81	38
972	80	41
973	81	30
974	81	23
975	81	19
976	81	25
977	81	29
978	83	47
979	81	90
980	81	75
981	80	60
982	81	48
983	81	41
984	81	30
985	80	24
986	81	20
987	81	21
988	81	29

Time (s)	Normalized speed (%)	Normalized torque (%)
989	81	29
990	81	27
991	81	23
992	81	25
993	81	26
994	81	22
995	81	20
996	81	17
997	81	23
998	83	65
999	81	54
1000	81	50
1001	81	41
1002	81	35
1003	81	37
1004	81	29
1005	81	28
1006	81	24
1007	81	19
1008	81	16
1009	80	16
1010	83	23
1011	83	17
1012	83	13
1013	83	27
1014	81	58
1015	81	60
1016	81	46
1017	80	41
1018	80	36
1019	81	26
1020	86	18
1021	82	35
1022	79	53
1023	82	30
1024	83	29
1025	83	32
1026	83	28
1027	76	60
1028	79	51

Time (s)	Normalized speed (%)	Normalized torque (%)
1029	86	26
1030	82	34
1031	84	25
1032	86	23
1033	85	22
1034	83	26
1035	83	25
1036	83	37
1037	84	14
1038	83	39
1039	76	70
1040	78	81
1041	75	71
1042	86	47
1043	83	35
1044	81	43
1045	81	41
1046	79	46
1047	80	44
1048	84	20
1049	79	31
1050	87	29
1051	82	49
1052	84	21
1053	82	56
1054	81	30
1055	85	21
1056	86	16
1057	79	52
1058	78	60
1059	74	55
1060	78	84
1061	80	54
1062	80	35
1063	82	24
1064	83	43
1065	79	49
1066	83	50
1067	86	12
1068	64	14

▼B

Time (s)	Normalized speed (%)	Normalized torque (%)
1069	24	14
1070	49	21
1071	77	48
1072	103	11
1073	98	48
1074	101	34
1075	99	39
1076	103	11
1077	103	19
1078	103	7
1079	103	13
1080	103	10
1081	102	13
1082	101	29
1083	102	25
1084	102	20
1085	96	60
1086	99	38
1087	102	24
1088	100	31
1089	100	28
1090	98	3
1091	102	26
1092	95	64
1093	102	23
1094	102	25
1095	98	42
1096	93	68
1097	101	25
1098	95	64
1099	101	35
1100	94	59
1101	97	37
1102	97	60
1103	93	98
1104	98	53
1105	103	13
1106	103	11
1107	103	11
1108	103	13

Time (s)	Normalized speed (%)	Normalized torque (%)
1109	103	10
1110	103	10
1111	103	11
1112	103	10
1113	103	10
1114	102	18
1115	102	31
1116	101	24
1117	102	19
1118	103	10
1119	102	12
1120	99	56
1121	96	59
1122	74	28
1123	66	62
1124	74	29
1125	64	74
1126	69	40
1127	76	2
1128	72	29
1129	66	65
1130	54	69
1131	69	56
1132	69	40
1133	73	54
1134	63	92
1135	61	67
1136	72	42
1137	78	2
1138	76	34
1139	67	80
1140	70	67
1141	53	70
1142	72	65
1143	60	57
1144	74	29
1145	69	31
1146	76	1
1147	74	22
1148	72	52

Time (s)	Normalized speed (%)	Normalized torque (%)
1149	62	96
1150	54	72
1151	72	28
1152	72	35
1153	64	68
1154	74	27
1155	76	14
1156	69	38
1157	66	59
1158	64	99
1159	51	86
1160	70	53
1161	72	36
1162	71	47
1163	70	42
1164	67	34
1165	74	2
1166	75	21
1167	74	15
1168	75	13
1169	76	10
1170	75	13
1171	75	10
1172	75	7
1173	75	13
1174	76	8
1175	76	7
1176	67	45
1177	75	13
1178	75	12
1179	73	21
1180	68	46
1181	74	8
1182	76	11
1183	76	14
1184	74	11
1185	74	18
1186	73	22
1187	74	20
1188	74	19

▼B

Time (s)	Normalized speed (%)	Normalized torque (%)
1189	70	22
1190	71	23
1191	73	19
1192	73	19
1193	72	20
1194	64	60
1195	70	39
1196	66	56
1197	68	64
1198	30	68
1199	70	38
1200	66	47
1201	76	14
1202	74	18
1203	69	46
1204	68	62
1205	68	62

Time (s)	Normalized speed (%)	Normalized torque (%)
1206	68	62
1207	68	62
1208	68	62
1209	68	62
1210	54	50
1211	41	37
1212	27	25
1213	14	12
1214	0	0
1215	0	0
1216	0	0
1217	0	0
1218	0	0
1219	0	0
1220	0	0
1221	0	0
1222	0	0

Time (s)	Normalized speed (%)	Normalized torque (%)
1223	0	0
1224	0	0
1225	0	0
1226	0	0
1227	0	0
1228	0	0
1229	0	0
1230	0	0
1231	0	0
1232	0	0
1233	0	0
1234	0	0
1235	0	0
1236	0	0
1237	0	0
1238	0	0

LSI-NRTC engine dynamometer schedule

Time (s)	Normalized speed (%)	Normalized torque (%)
0	0	0
1	0	0
2	0	0
3	0	0
4	0	0
5	0	0
6	0	0
7	0	0
8	0	0
9	1	8
10	6	54
11	8	61
12	34	59
13	22	46
14	5	51
15	18	51
16	31	50
17	30	56

Time (s)	Normalized speed (%)	Normalized torque (%)
18	31	49
19	25	66
20	58	55
21	43	31
22	16	45
23	24	38
24	24	27
25	30	33
26	45	65
27	50	49
28	23	42
29	13	42
30	9	45
31	23	30
32	37	45
33	44	50
34	49	52
35	55	49

Time (s)	Normalized speed (%)	Normalized torque (%)
36	61	46
37	66	38
38	42	33
39	17	41
40	17	37
41	7	50
42	20	32
43	5	55
44	30	42
45	44	53
46	45	56
47	41	52
48	24	41
49	15	40
50	11	44
51	32	31
52	38	54
53	38	47

▼B

Time (s)	Normalized speed (%)	Normalized torque (%)
54	9	55
55	10	50
56	33	55
57	48	56
58	49	47
59	33	44
60	52	43
61	55	43
62	59	38
63	44	28
64	24	37
65	12	44
66	9	47
67	12	52
68	34	21
69	29	44
70	44	54
71	54	62
72	62	57
73	72	56
74	88	71
75	100	69
76	100	34
77	100	42
78	100	54
79	100	58
80	100	38
81	83	17
82	61	15
83	43	22
84	24	35
85	16	39
86	15	45
87	32	34
88	14	42
89	8	48
90	5	51
91	10	41
92	12	37
93	4	47

Time (s)	Normalized speed (%)	Normalized torque (%)
94	3	49
95	3	50
96	4	49
97	4	48
98	8	43
99	2	51
100	5	46
101	8	41
102	4	47
103	3	49
104	6	45
105	3	48
106	10	42
107	18	27
108	3	50
109	11	41
110	34	29
111	51	57
112	67	63
113	61	32
114	44	31
115	48	54
116	69	65
117	85	65
118	81	29
119	74	21
120	62	23
121	76	58
122	96	75
123	100	77
124	100	27
125	100	79
126	100	79
127	100	81
128	100	57
129	99	52
130	81	35
131	69	29
132	47	22
133	34	28

Time (s)	Normalized speed (%)	Normalized torque (%)
134	27	37
135	83	60
136	100	74
137	100	7
138	100	2
139	70	18
140	23	39
141	5	54
142	11	40
143	11	34
144	11	41
145	19	25
146	16	32
147	20	31
148	21	38
149	21	42
150	9	51
151	4	49
152	2	51
153	1	58
154	21	57
155	29	47
156	33	45
157	16	49
158	38	45
159	37	43
160	35	42
161	39	43
162	51	49
163	59	55
164	65	54
165	76	62
166	84	59
167	83	29
168	67	35
169	84	54
170	90	58
171	93	43
172	90	29
173	66	19

▼B

Time (s)	Normalized speed (%)	Normalized torque (%)
174	52	16
175	49	17
176	56	38
177	73	71
178	86	80
179	96	75
180	89	27
181	66	17
182	50	18
183	36	25
184	36	24
185	38	40
186	40	50
187	27	48
188	19	48
189	23	50
190	19	45
191	6	51
192	24	48
193	49	67
194	47	49
195	22	44
196	25	40
197	38	54
198	43	55
199	40	52
200	14	49
201	11	45
202	7	48
203	26	41
204	41	59
205	53	60
206	44	54
207	22	40
208	24	41
209	32	53
210	44	74
211	57	25
212	22	49
213	29	45

Time (s)	Normalized speed (%)	Normalized torque (%)
214	19	37
215	14	43
216	36	40
217	43	63
218	42	49
219	15	50
220	19	44
221	47	59
222	67	80
223	76	74
224	87	66
225	98	61
226	100	38
227	97	27
228	100	53
229	100	72
230	100	49
231	100	4
232	100	13
233	87	15
234	53	26
235	33	27
236	39	19
237	51	33
238	67	54
239	83	60
240	95	52
241	100	50
242	100	36
243	100	25
244	85	16
245	62	16
246	40	26
247	56	39
248	81	75
249	98	86
250	100	76
251	100	51
252	100	78
253	100	83

Time (s)	Normalized speed (%)	Normalized torque (%)
254	100	100
255	100	66
256	100	85
257	100	72
258	100	45
259	98	58
260	60	30
261	43	32
262	71	36
263	44	32
264	24	38
265	42	17
266	22	51
267	13	53
268	23	45
269	29	50
270	28	42
271	21	55
272	34	57
273	44	47
274	19	46
275	13	44
276	25	36
277	43	51
278	55	73
279	68	72
280	76	63
281	80	45
282	83	40
283	78	26
284	60	20
285	47	19
286	52	25
287	36	30
288	40	26
289	45	34
290	47	35
291	42	28
292	46	38
293	48	44

▼B

Time (s)	Normalized speed (%)	Normalized torque (%)
294	68	61
295	70	47
296	48	28
297	42	22
298	31	29
299	22	35
300	28	28
301	46	46
302	62	69
303	76	81
304	88	85
305	98	81
306	100	74
307	100	13
308	100	11
309	100	17
310	99	3
311	80	7
312	62	11
313	63	11
314	64	16
315	69	43
316	81	67
317	93	74
318	100	72
319	94	27
320	73	15
321	40	33
322	40	52
323	50	50
324	11	53
325	12	45
326	5	50
327	1	55
328	7	55
329	62	60
330	80	28
331	23	37
332	39	58
333	47	24

Time (s)	Normalized speed (%)	Normalized torque (%)
334	59	51
335	58	68
336	36	52
337	18	42
338	36	52
339	59	73
340	72	85
341	85	92
342	99	90
343	100	72
344	100	18
345	100	76
346	100	64
347	100	87
348	100	97
349	100	84
350	100	100
351	100	91
352	100	83
353	100	93
354	100	100
355	94	43
356	72	10
357	77	3
358	48	2
359	29	5
360	59	19
361	63	5
362	35	2
363	24	3
364	28	2
365	36	16
366	54	23
367	60	10
368	33	1
369	23	0
370	16	0
371	11	0
372	20	0
373	25	2

Time (s)	Normalized speed (%)	Normalized torque (%)
374	40	3
375	33	4
376	34	5
377	46	7
378	57	10
379	66	11
380	75	14
381	79	11
382	80	16
383	92	21
384	99	16
385	83	2
386	71	2
387	69	4
388	67	4
389	74	16
390	86	25
391	97	28
392	100	15
393	83	2
394	62	4
395	40	6
396	49	10
397	36	5
398	27	4
399	29	3
400	22	2
401	13	3
402	37	36
403	90	26
404	41	2
405	25	2
406	29	2
407	38	7
408	50	13
409	55	10
410	29	3
411	24	7
412	51	16
413	62	15

▼B

Time (s)	Normalized speed (%)	Normalized torque (%)
414	72	35
415	91	74
416	100	73
417	100	8
418	98	11
419	100	59
420	100	98
421	100	99
422	100	75
423	100	95
424	100	100
425	100	97
426	100	90
427	100	86
428	100	82
429	97	43
430	70	16
431	50	20
432	42	33
433	89	64
434	89	77
435	99	95
436	100	41
437	77	12
438	29	37
439	16	41
440	16	38
441	15	36
442	18	44
443	4	55
444	24	26
445	26	35
446	15	45
447	21	39
448	29	52
449	26	46
450	27	50
451	13	43
452	25	36
453	37	57

Time (s)	Normalized speed (%)	Normalized torque (%)
454	29	46
455	17	39
456	13	41
457	19	38
458	28	35
459	8	51
460	14	36
461	17	47
462	34	39
463	34	57
464	11	70
465	13	51
466	13	68
467	38	44
468	53	67
469	29	69
470	19	65
471	52	45
472	61	79
473	29	70
474	15	53
475	15	60
476	52	40
477	50	61
478	13	74
479	46	51
480	60	73
481	33	84
482	31	63
483	41	42
484	26	69
485	23	65
486	48	49
487	28	57
488	16	67
489	39	48
490	47	73
491	35	87
492	26	73
493	30	61

Time (s)	Normalized speed (%)	Normalized torque (%)
494	34	49
495	35	66
496	56	47
497	49	64
498	59	64
499	42	69
500	6	77
501	5	59
502	17	59
503	45	53
504	21	62
505	31	60
506	53	68
507	48	79
508	45	61
509	51	47
510	41	48
511	26	58
512	21	62
513	50	52
514	39	65
515	23	65
516	42	62
517	57	80
518	66	81
519	64	62
520	45	42
521	33	42
522	27	57
523	31	59
524	41	53
525	45	72
526	48	73
527	46	90
528	56	76
529	64	76
530	69	64
531	72	59
532	73	58
533	71	56

▼B

Time (s)	Normalized speed (%)	Normalized torque (%)
534	66	48
535	61	50
536	55	56
537	52	52
538	54	49
539	61	50
540	64	54
541	67	54
542	68	52
543	60	53
544	52	50
545	45	49
546	38	45
547	32	45
548	26	53
549	23	56
550	30	49
551	33	55
552	35	59
553	33	65
554	30	67
555	28	59
556	25	58
557	23	56
558	22	57
559	19	63
560	14	63
561	31	61
562	35	62
563	21	80
564	28	65
565	7	74
566	23	54
567	38	54
568	14	78
569	38	58
570	52	75
571	59	81
572	66	69
573	54	44

Time (s)	Normalized speed (%)	Normalized torque (%)
574	48	34
575	44	33
576	40	40
577	28	58
578	27	63
579	35	45
580	20	66
581	15	60
582	10	52
583	22	56
584	30	62
585	21	67
586	29	53
587	41	56
588	15	67
589	24	56
590	42	69
591	39	83
592	40	73
593	35	67
594	32	61
595	30	65
596	30	72
597	48	51
598	66	58
599	62	71
600	36	63
601	17	59
602	16	50
603	16	62
604	34	48
605	51	66
606	35	74
607	15	56
608	19	54
609	43	65
610	52	80
611	52	83
612	49	57
613	48	46

Time (s)	Normalized speed (%)	Normalized torque (%)
614	37	36
615	25	44
616	14	53
617	13	64
618	23	56
619	21	63
620	18	67
621	20	54
622	16	67
623	26	56
624	41	65
625	28	62
626	19	60
627	33	56
628	37	70
629	24	79
630	28	57
631	40	57
632	40	58
633	28	44
634	25	41
635	29	53
636	31	55
637	26	64
638	20	50
639	16	53
640	11	54
641	13	53
642	23	50
643	32	59
644	36	63
645	33	59
646	24	52
647	20	52
648	22	55
649	30	53
650	37	59
651	41	58
652	36	54
653	29	49

▼B

Time (s)	Normalized speed (%)	Normalized torque (%)
654	24	53
655	14	57
656	10	54
657	9	55
658	10	57
659	13	55
660	15	64
661	31	57
662	19	69
663	14	59
664	33	57
665	41	65
666	39	64
667	39	59
668	39	51
669	28	41
670	19	49
671	27	54
672	37	63
673	32	74
674	16	70
675	12	67
676	13	60
677	17	56
678	15	62
679	25	47
680	27	64
681	14	71
682	5	65
683	6	57
684	6	57
685	15	52
686	22	61
687	14	77
688	12	67
689	12	62
690	14	59
691	15	58
692	18	55
693	22	53

Time (s)	Normalized speed (%)	Normalized torque (%)
694	19	69
695	14	67
696	9	63
697	8	56
698	17	49
699	25	55
700	14	70
701	12	60
702	22	57
703	27	67
704	29	68
705	34	62
706	35	61
707	28	78
708	11	71
709	4	58
710	5	58
711	10	56
712	20	63
713	13	76
714	11	65
715	9	60
716	7	55
717	8	53
718	10	60
719	28	53
720	12	73
721	4	64
722	4	61
723	4	61
724	10	56
725	8	61
726	20	56
727	32	62
728	33	66
729	34	73
730	31	61
731	33	55
732	33	60
733	31	59

Time (s)	Normalized speed (%)	Normalized torque (%)
734	29	58
735	31	53
736	33	51
737	33	48
738	27	44
739	21	52
740	13	57
741	12	56
742	10	64
743	22	47
744	15	74
745	8	66
746	34	47
747	18	71
748	9	57
749	11	55
750	12	57
751	10	61
752	16	53
753	12	75
754	6	70
755	12	55
756	24	50
757	28	60
758	28	64
759	23	60
760	20	56
761	26	50
762	28	55
763	18	56
764	15	52
765	11	59
766	16	59
767	34	54
768	16	82
769	15	64
770	36	53
771	45	64
772	41	59
773	34	50

▼B

Time (s)	Normalized speed (%)	Normalized torque (%)
774	27	45
775	22	52
776	18	55
777	26	54
778	39	62
779	37	71
780	32	58
781	24	48
782	14	59
783	7	59
784	7	55
785	18	49
786	40	62
787	44	73
788	41	68
789	35	48
790	29	54
791	22	69
792	46	53
793	59	71
794	69	68
795	75	47
796	62	32
797	48	35
798	27	59
799	13	58
800	14	54
801	21	53
802	23	56
803	23	57
804	23	65
805	13	65
806	9	64
807	27	56
808	26	78
809	40	61
810	35	76
811	28	66
812	23	57
813	16	50

Time (s)	Normalized speed (%)	Normalized torque (%)
814	11	53
815	9	57
816	9	62
817	27	57
818	42	69
819	47	75
820	53	67
821	61	62
822	63	53
823	60	54
824	56	44
825	49	39
826	39	35
827	30	34
828	33	46
829	44	56
830	50	56
831	44	52
832	38	46
833	33	44
834	29	45
835	24	46
836	18	52
837	9	55
838	10	54
839	20	53
840	27	58
841	29	59
842	30	62
843	30	65
844	27	66
845	32	58
846	40	56
847	41	57
848	18	73
849	15	55
850	18	50
851	17	52
852	20	49
853	16	62

Time (s)	Normalized speed (%)	Normalized torque (%)
854	4	67
855	2	64
856	7	54
857	10	50
858	9	57
859	5	62
860	12	51
861	14	65
862	9	64
863	31	50
864	30	78
865	21	65
866	14	51
867	10	55
868	6	59
869	7	59
870	19	54
871	23	61
872	24	62
873	34	61
874	51	67
875	60	66
876	58	55
877	60	52
878	64	55
879	68	51
880	63	54
881	64	50
882	68	58
883	73	47
884	63	40
885	50	38
886	29	61
887	14	61
888	14	53
889	42	6
890	58	6
891	58	6
892	77	39
893	93	56

▼B

Time (s)	Normalized speed (%)	Normalized torque (%)
894	93	44
895	93	37
896	93	31
897	93	25
898	93	26
899	93	27
900	93	25
901	93	21
902	93	22
903	93	24
904	93	23
905	93	27
906	93	34
907	93	32
908	93	26
909	93	31
910	93	34
911	93	31
912	93	33
913	93	36
914	93	37
915	93	34
916	93	30
917	93	32
918	93	35
919	93	35
920	93	32
921	93	28
922	93	23
923	94	18
924	95	18
925	96	17
926	95	13
927	96	10
928	95	9
929	95	7
930	95	7
931	96	7
932	96	6
933	96	6

Time (s)	Normalized speed (%)	Normalized torque (%)
934	95	6
935	90	6
936	69	43
937	76	62
938	93	47
939	93	39
940	93	35
941	93	34
942	93	36
943	93	39
944	93	34
945	93	26
946	93	23
947	93	24
948	93	24
949	93	22
950	93	19
951	93	17
952	93	19
953	93	22
954	93	24
955	93	23
956	93	20
957	93	20
958	94	19
959	95	19
960	95	17
961	96	13
962	95	10
963	96	9
964	95	7
965	95	7
966	95	7
967	95	6
968	96	6
969	96	6
970	89	6
971	68	6
972	57	6
973	66	32

Time (s)	Normalized speed (%)	Normalized torque (%)
974	84	52
975	93	46
976	93	42
977	93	36
978	93	28
979	93	23
980	93	19
981	93	16
982	93	15
983	93	16
984	93	15
985	93	14
986	93	15
987	93	16
988	94	15
989	93	32
990	93	45
991	93	43
992	93	37
993	93	29
994	93	23
995	93	20
996	93	18
997	93	16
998	93	17
999	93	16
1000	93	15
1001	93	15
1002	93	15
1003	93	14
1004	93	15
1005	93	15
1006	93	14
1007	93	13
1008	93	14
1009	93	14
1010	93	15
1011	93	16
1012	93	17
1013	93	20

▼B

Time (s)	Normalized speed (%)	Normalized torque (%)
1014	93	22
1015	93	20
1016	93	19
1017	93	20
1018	93	19
1019	93	19
1020	93	20
1021	93	32
1022	93	37
1023	93	28
1024	93	26
1025	93	24
1026	93	22
1027	93	22
1028	93	21
1029	93	20
1030	93	20
1031	93	20
1032	93	20
1033	93	19
1034	93	18
1035	93	20
1036	93	20
1037	93	20
1038	93	20
1039	93	19
1040	93	18
1041	93	18
1042	93	17
1043	93	16
1044	93	16
1045	93	15
1046	93	16
1047	93	18
1048	93	37
1049	93	48
1050	93	38
1051	93	31
1052	93	26
1053	93	21

Time (s)	Normalized speed (%)	Normalized torque (%)
1054	93	18
1055	93	16
1056	93	17
1057	93	18
1058	93	19
1059	93	21
1060	93	20
1061	93	18
1062	93	17
1063	93	17
1064	93	18
1065	93	18
1066	93	18
1067	93	19
1068	93	18
1069	93	18
1070	93	20
1071	93	23
1072	93	25
1073	93	25
1074	93	24
1075	93	24
1076	93	22
1077	93	22
1078	93	22
1079	93	19
1080	93	16
1081	95	17
1082	95	37
1083	93	43
1084	93	32
1085	93	27
1086	93	26
1087	93	24
1088	93	22
1089	93	22
1090	93	22
1091	93	23
1092	93	22
1093	93	22

Time (s)	Normalized speed (%)	Normalized torque (%)
1094	93	23
1095	93	23
1096	93	23
1097	93	22
1098	93	23
1099	93	23
1100	93	23
1101	93	25
1102	93	27
1103	93	26
1104	93	25
1105	93	27
1106	93	27
1107	93	27
1108	93	24
1109	93	20
1110	93	18
1111	93	17
1112	93	17
1113	93	18
1114	93	18
1115	93	18
1116	93	19
1117	93	22
1118	93	22
1119	93	19
1120	93	17
1121	93	17
1122	93	18
1123	93	18
1124	93	19
1125	93	19
1126	93	20
1127	93	19
1128	93	20
1129	93	25
1130	93	30
1131	93	31
1132	93	26
1133	93	21

▼B

Time (s)	Normalized speed (%)	Normalized torque (%)
1134	93	18
1135	93	20
1136	93	25
1137	93	24
1138	93	21
1139	93	21
1140	93	22
1141	93	22
1142	93	28
1143	93	29
1144	93	23
1145	93	21
1146	93	18
1147	93	16
1148	93	16
1149	93	16
1150	93	17
1151	93	17
1152	93	17
1153	93	17
1154	93	23
1155	93	26
1156	93	22
1157	93	18
1158	93	16
1159	93	16

Time (s)	Normalized speed (%)	Normalized torque (%)
1160	93	17
1161	93	19
1162	93	18
1163	93	16
1164	93	19
1165	93	22
1166	93	25
1167	93	29
1168	93	27
1169	93	22
1170	93	18
1171	93	16
1172	93	19
1173	93	19
1174	93	17
1175	93	17
1176	93	17
1177	93	16
1178	93	16
1179	93	15
1180	93	16
1181	93	15
1182	93	17
1183	93	21
1184	93	30
1185	93	53

Time (s)	Normalized speed (%)	Normalized torque (%)
1186	93	54
1187	93	38
1188	93	30
1189	93	24
1190	93	20
1191	95	20
1192	96	18
1193	96	15
1194	96	11
1195	95	9
1196	95	8
1197	96	7
1198	94	33
1199	93	46
1200	93	37
1201	16	8
1202	0	0
1203	0	0
1204	0	0
1205	0	0
1206	0	0
1207	0	0
1208	0	0
1209	0	0