

This document is meant purely as a documentation tool and the institutions do not assume any liability for its contents

► **B**

► **M6 COUNCIL DIRECTIVE**

of 20 March 1970

on the approximation of the laws of the Member States on measures to be taken against air pollution by emissions from motor vehicles

(70/220/EEC) ◀

(OJ L 76, 6.4.1970, p. 1)

Amended by:

	Official Journal		
	No	page	date
► <b>M1</b> Council Directive 74/290/EEC of 28 May 1974	L 159	61	15.6.1974
► <b>M2</b> Commission Directive 77/102/EEC of 30 November 1976	L 32	32	3.2.1977
► <b>M3</b> Commission Directive 78/665/EEC of 14 July 1978	L 223	48	14.8.1978
► <b>M4</b> Council Directive 83/351/EEC of 16 June 1983	L 197	1	20.7.1983
► <b>M5</b> Council Directive 88/76/EEC of 3 December 1987	L 36	1	9.2.1988
► <b>M6</b> Council Directive 88/436/EEC of 16 June 1988	L 214	1	6.8.1988
► <b>M7</b> Council Directive 89/458/EEC of 18 July 1989	L 226	1	3.8.1989
► <b>M8</b> Commission Directive 89/491/EEC of 17 July 1989	L 238	43	15.8.1989
► <b>M9</b> Council Directive 91/441/EEC of 26 June 1991	L 242	1	30.8.1991
► <b>M10</b> Council Directive 93/59/EEC of 28 June 1993	L 186	21	28.7.1993
► <b>M11</b> Directive 94/12/EC of the European Parliament and the Council of 23 March 1994	L 100	42	19.4.1994
► <b>M12</b> Commission Directive 96/44/EC of 1 July 1996	L 210	25	20.8.1996
► <b>M13</b> Directive 96/69/EC of the European Parliament and of the Council of 8 October 1996	L 282	64	1.11.1996

Amended by:

► <b>A1</b> Act of Accession of Denmark, Ireland and the United Kingdom of Great Britain and Northern Ireland	L 73	14	27.3.1972
---	------	----	-----------

Corrected by:

- **C1** Corrigendum, OJ L 303, 8.11.1988, p. 36 (88/436/EEC)
- **C2** Corrigendum, OJ L 270, 19.9.1989, p. 16 (89/458/EEC)

▼B  
▼M6

**COUNCIL DIRECTIVE**  
**of 20 March 1970**

**on the approximation of the laws of the Member States on measures to be taken against air pollution by emissions from motor vehicles**

(70/220/EEC)

▼B

THE COUNCIL OF THE EUROPEAN COMMUNITIES,

Having regard to the Treaty establishing the European Economic Community, and in particular Article 100 thereof;

Having regard to the proposal from the Commission;

Having regard to the Opinion of the European Parliament<sup>(1)</sup>;

Having regard to the Opinion of the Economic and Social Committee<sup>(2)</sup>;

Whereas a regulation of 14 October 1968 amending the *Straßenverkehrs-Zulassungs-Ordnung* was published in Germany in the *Bundesgesetzblatt* Part I of 18 October 1968; whereas that regulation contains provisions on measures to be taken against air pollution by positive-ignition engines of motor vehicles; whereas those provisions will enter into force on 1 October 1970;

Whereas a regulation of 31 March 1969 on the 'Composition of exhaust gases emitted from petrol engines of motor vehicles' was published in France in the *Journal officiel* of 17 May 1969; whereas that regulation is applicable:

- from 1 September 1971, to type-approved vehicles with a new type of engine, that is to say, a type of engine which has never before been installed in a type-approved vehicle;
- from 1 September 1972, to vehicles put into service for the first time;

Whereas those provisions are liable to hinder the establishment and proper functioning of the common market; whereas it is therefore necessary that all Member States adopt the same requirements, either in addition to or in place of their existing rules, in order, in particular, to allow the EEC type — approval procedure which was the subject of the Council Directive<sup>(3)</sup> of 6 February 1970 on the approximation of the laws of the Member States relating to the type approval of motor vehicles and their trailers to be applied in respect of each type of vehicle;

Whereas, however, the present Directive will be applied before the date laid down for the application of the Directive of 6 February 1970; whereas at that time therefore the procedures of this last Directive will not yet be applicable; whereas therefore an *ad hoc* procedure must be laid down in the form of a communication certifying that a vehicle type has been tested and that it satisfies the requirements of this Directive;

Whereas, on the basis of that communication, each Member State requested to grant national type approval of a type of vehicle must be able to ascertain whether that type has been submitted to the tests laid down in this Directive; whereas, to this end, each Member State should inform the other Member States of its findings by sending them a copy of the communication completed for each type of motor vehicle which has been tested;

<sup>(1)</sup> OJ No C 160, 18.12.1969, p. 7.

<sup>(2)</sup> OJ No C 48, 16.4.1969, p. 16.

<sup>(3)</sup> OJ No L 42, 23.2.1970, p. 1.

**▼B**

Whereas a longer period of adaptation should be laid down for industry in respect of the requirements relating to the testing of the average emission of gaseous pollutants in a congested urban area after a cold start than in respect of the other technical requirements of this Directive;

Whereas it is desirable to use the technical requirements adopted by the UN Economic Commission for Europe in its Regulation No 15<sup>(1)</sup> (Uniform provisions concerning the approval of vehicles equipped with a positive-ignition engine with regard to the emission of gaseous pollutants by the engine), annexed to the Agreement of 20 March 1958 concerning the adoption of uniform conditions of approval and reciprocal recognition of approval for motor vehicle equipment and parts;

Whereas, furthermore, the technical requirements must be rapidly adapted to take account of technical progress; whereas, to this end, provision should be made for application of the procedure laid down in Article 13 of the Council Directive of 6 February 1970 on the type approval of motor vehicles and their trailers;

HAS ADOPTED THIS DIRECTIVE:

**▼M4***Article 1*

For the purposes of this Directive, 'vehicle' means any vehicle with a positive-ignition engine or with a compression-ignition engine, intended for use on the road, with or without bodywork, having at least four wheels, a permissible maximum mass of at least 400 kg and a maximum design speed equal to or exceeding 50 km/h, with the exception of agricultural tractors and machinery and public works vehicles.

**▼B***Article 2*

No Member State may refuse to grant EEC type approval or national type approval of a vehicle on grounds relating to air pollution by gases from positive-ignition engines of motor vehicles:

- from 1 October 1970, where that vehicle satisfies both the requirements contained in Annex I, with the exception of those in items 3.2.1.1 and 3.2.2.1, and the requirements contained in Annexes II, IV, V and VI;
- from 1 October 1971, where that vehicle satisfies, in addition, the requirements contained in items 3.2.1.1 and 3.2.2.1 of Annex I and in Annex III.

**▼A1***Article 2a*

No Member State may refuse or prohibit the sale or registration, entry into service or use of a vehicle on grounds relating to air pollution by gases from positive-ignition engines of motor vehicles if that vehicle satisfies the requirements set out in Annexes I, II, III, IV, V and VI.

**▼B***Article 3*

1. On application being made by a manufacturer or his authorised representative, the competent authorities of the Member State concerned shall complete the sections of the communication provided for in Annex VII. A copy of that communication shall be sent to the other Member States and to the applicant. Other Member States which are requested to grant national type approval for the same type of vehicle shall accept that document as proof that the tests provided for have been carried out.

<sup>(1)</sup> ECE (Geneva) Document W/TRANS/WP 29/293/Rev. 1, 11.4.1969.

**▼B**

2. The provisions of paragraph 1 shall be revoked as soon as the Council Directive of 6 February 1970 on the type approval of motor vehicles and their trailers enters into force.

*Article 4*

The Member State which has granted type approval shall take the necessary measures to ensure that it is informed of any modification of a part or characteristic referred to in item 1.1 of Annex I. The competent authorities of that Member State shall determine whether fresh tests should be carried out on the modified prototype and whether a fresh report should be drawn up. Where such tests reveal failure to comply with the requirements of this Directive, the modification shall not be approved.

*Article 5*

The amendments necessary for adjusting the requirements of Annexes I to VII so as to take account of technical progress shall be adopted in accordance with the procedure laid down in Article 13 of the Council Directive of 6 February 1970 on the type approval of motor vehicles and their trailers.

*Article 6*

1. Member States shall adopt provisions containing the requirements needed in order to comply with this Directive before 30 June 1970 and shall forthwith inform the Commission thereof.
2. Member States shall ensure that they communicate to the Commission the text of the main provisions of national law which they adopt in the field covered by this Directive.

*Article 7*

This Directive is addressed to the Member States.

▼ **M12**

## LIST OF ANNEXES

- ANNEX I: Scope, definitions, application for EEC type-approval, granting of EEC type-approval, requirements and tests, modifications of the type, conformity of production, transitional provisions
- ANNEX II: Information document  
*Appendix:* Information on test conditions
- ANNEX III: Type I test (verifying the average emission of tailpipe emissions after a cold start)  
*Appendix 1:* Operating cycle used for the type I test  
*Appendix 2:* Chassis dynamometer  
*Appendix 3:* Measurement method on the road-simulation on a chassis dynamometer  
*Appendix 4:* Verification of inertias other than mechanical  
*Appendix 5:* Description of tailpipe emission-sampling systems  
*Appendix 6:* Method of calibrating the equipment  
*Appendix 7:* Total system verification  
*Appendix 8:* Calculation of the emission of pollutants
- ANNEX IV: Type II test (carbon monoxide emission test at idling speed)
- ANNEX V: Type III test (verifying emissions of crankcase gases)
- ANNEX VI: Type IV test (determination of evaporative emissions from vehicles with spark-ignition engines)  
*Appendix:* Calibration of equipment for evaporative emission testing
- ANNEX VII: Type V test (ageing test for verifying the durability of anti-pollution devices)
- ANNEX VIII: Specifications and reference fuels
- ANNEX IX: EEC type-approval certificate  
*Appendix:* Addendum

▼ M9

## ANNEX I

▼ M12

**SCOPE, DEFINITIONS, APPLICATION FOR EEC TYPE-APPROVAL, GRANTING OF EEC TYPE-APPROVAL, REQUIREMENTS AND TESTS, MODIFICATIONS OF THE TYPE, CONFORMITY OF PRODUCTION, TRANSITIONAL PROVISIONS**

▼ M9

## 1. SCOPE

▼ M12

This Directive applies to

- the tailpipe emissions, evaporative emissions, emissions of crankcase gases and the durability of anti-pollution devices for all motor vehicles equipped with positive-ignition engines and
- the tailpipe emissions and the durability of anti-pollution devices from vehicles of categories M<sub>1</sub> and N<sub>1</sub> <sup>(1)</sup> equipped with compression-ignition engines

covered by Article 1 of Directive 70/220/EEC in the version of Council Directive 83/351/EEC <sup>(2)</sup>, with the exception of those vehicles of category N<sub>1</sub> for which type-approval has been granted pursuant to Council Directive 88/77/EEC <sup>(3)</sup>.

▼ M9

At the request of the manufacturers, type-approval pursuant to this Directive may be extended from M<sub>1</sub> or N<sub>1</sub> vehicles equipped with compression ignition engines which have already been type-approved, to M<sub>2</sub> and N<sub>2</sub> vehicles having a reference mass not exceeding 2 840 kg and meeting the conditions of section 6 of this Annex (extension of EEC type-approval).

## 2. DEFINITIONS

For the purposes of this Directive:

- 2.1. 'Vehicle type' with regard to the tailpipe emissions from the engine, means a category of power-driven vehicles which do not differ in such essential respects as:
  - 2.1.1. the equivalent inertia determined in relation to the reference mass as prescribed in section 5.1 of Annex III; and
  - 2.1.2. the engine and vehicle characteristics as defined in Annex II.
- 2.2. 'Reference mass' means the mass of the vehicle in running order less the uniform mass of the driver of 75 kg and increased by a uniform mass of 100 kg.
  - 2.2.1. 'Mass of the vehicle in running order' means the mass defined in section 2.6 of Annex I to Directive 70/156/EEC.
- 2.3. 'Maximum mass' means the mass defined in section 2.7 of Annex I to Directive 70/156/EEC.
- 2.4. 'Gaseous pollutants' means the exhaust gas emissions of carbon monoxide, hydrocarbons (assuming a ratio of C<sub>1</sub>H<sub>1,85</sub>), and oxides of nitrogen, expressed in nitrogen dioxide (NO<sub>2</sub>) equivalent.
- 2.5. 'Particulate pollutants' means components of the exhaust gas which are removed from the diluted exhaust gas at a maximum temperature of 325 K (52 °C) by means of the filters described in Annex III.
- 2.6. 'Tailpipe emissions' means:
  - for positive-ignition engines, the emission of gaseous pollutants,
  - for compression-ignition engines, the emission of gaseous and particulate pollutants.

<sup>(1)</sup> As defined in Annex II A to Directive 70/156/EEC.

<sup>(2)</sup> OJ No L 197, 20. 7. 1983, p. 1.

<sup>(3)</sup> OJ No L 36, 9. 2. 1988, p. 33.

**▼ M9**

- 2.7. 'Evaporative emissions' means the hydrocarbon vapours lost from the fuel system of a motor vehicle other than those from tailpipe emissions.
- 2.7.1. 'Tank breathing losses' are hydrocarbon emissions caused by temperature changes in the fuel tank (assuming a ratio of  $C_1H_{2,33}$ ).
- 2.7.2. 'Hot soak losses' are hydrocarbon emissions arising from the fuel system of a stationary vehicle after a period of driving (assuming a ratio of  $C_1H_{2,20}$ ).
- 2.8. 'Engine crankcase' means the spaces in, or external to, an engine which are connected to the oil sump by internal or external ducts through which gases and vapours can escape.
- 2.9. 'Cold start device' means a device which temporarily enriches the air/fuel mixture of the engine thus assisting the engine to start.
- 2.10. 'Starting aid' means a device which assists the engine to start without enrichment of the air/fuel mixture of the engine, e.g. glow plugs, modifications to the injection timing.
- 2.11. 'Engine capacity' means:
- 2.11.1. for reciprocating piston engines, the nominal engine swept volume,
- 2.11.2. for rotary piston (Wankel) engines, double the nominal engine swept volume.
- 2.12. 'Anti-pollution device' means those components of a vehicle that control and/or limit tailpipe and evaporative emissions.
3. APPLICATION FOR EEC TYPE-APPROVAL

**▼ M11**

- 3.1. The application for type-approval pursuant to Article 3 of Directive 70/156/EEC of a vehicle type with regard to its tailpipe emissions, evaporative emissions and durability of antipollution devices is submitted by the vehicle manufacturer.

**▼ M12**

- 3.2. A model for the information document is given in Annex II.

- 
- 3.2.1. Where appropriate, copies of other type-approvals with the relevant data to enable extensions of approvals and establishment of deterioration factors shall also be submitted.

**▼ M9**

- 3.3. For the tests described in Section 5 of this Annex a vehicle representative of the vehicle type to be approved must be submitted to the technical service responsible for the type-approval tests.

**▼ M11**

4. GRANTING OF EC-TYPE-APPROVAL
- 4.1. If the relevant requirements are satisfied, EEC type-approval shall be granted pursuant to Article 4 (3) of Directive 70/156/EEC.
- 4.2. A model for the EC-type-approval certificate is given in Annex IX.

**▼ M12**

- 4.3. An approval number in accordance with Annex VII to Directive 70/156/EEC shall be assigned to each type of vehicle approved. The same Member State shall not assign the same number to another type of vehicle.

**▼ M9**

5. REQUIREMENTS AND TESTS

*Note:*

As an alternative to the requirements of this section, vehicle manufacturers whose world-wide annual production is less than 10 000 units may obtain type-approval on the basis of the corresponding technical requirements in:

- the code of Federal Regulations, Title 40, Part 86, subparts A and B, applicable to 1987 model year light-duty vehicles,

**▼ M9**

revised as of 1 July 1989 and published by the US Government Printing Office, or

- the 'Master Document', in its final version dated 25 September 1987, prepared by the International meeting in Stockholm on Air Pollution by Motor Vehicles, entitled 'Control of Air Pollution from Motor Vehicles — General Provisions for Emission Regulations for Light Motor Vehicles.'

The type-approval authority must notify the Commission of the circumstances of each approval granted under this provision.

5.1. **General**

- 5.1.1. The components liable to effect tailpipe and evaporative emissions must be so designed, constructed and assembled as to enable the vehicle, in normal use, to comply with the requirements of this Directive, despite the vibration to which they may be subjected.

The technical measures taken by the manufacturer must be such as to ensure that the tailpipe and evaporative emissions are effectively limited, pursuant to this Directive, throughout the normal life of the vehicle and under normal conditions of use. For tailpipe emissions, these provisions are deemed to be met if the provisions of sections 5.3.1.4 and 7.1.1.1 are respectively complied with.

If an oxygen sensor is used in the catalytic converter system, steps must be taken to ensure that the stoichiometric air-fuel ratio (lambda) is maintained when a certain speed is reached or when accelerating.

However, temporary variations in this ratio are permissible if they also occur during the test defined in sections 5.3.1 and 7.1.1 respectively, or if these variations are necessary for safe driving and for the correct operation of the engine and of components which affect pollutant emissions or if these variations are necessary for cold starting.

- 5.1.2. A vehicle equipped with a positive-ignition engine must be designed to be capable of running on unleaded petrol as specified by Directive 85/210/EEC<sup>(1)</sup>.
- 5.1.2.1. Subject to 5.1.2.2, the inlet orifice of the fuel tank must be so designed that it prevents the tank from being filled from a petrol pump delivery nozzle which has an external diameter of 23,6 mm or greater.
- 5.1.2.2. Section 5.1.2.1 does not apply to a vehicle in respect of which both of the following conditions are satisfied, that is to say:
- 5.1.2.2.1. that the vehicle is so designed and constructed that no device designed to control the emission of gaseous pollutants is adversely affected by leaded petrol, and
- 5.1.2.2.2. that the vehicle is conspicuously, legibly and indelibly marked with the symbol for unleaded petrol specified in ISO 2575-1982 in a position immediately visible to a person filling the fuel tank. Additional markings are permitted.

5.2. **Application of tests**

Figure 1.5.2 illustrates the routes for type-approval of a vehicle.

**▼ M10**

- 5.2.1. Positive ignition engined vehicles must be subject to the following tests:
- Type I: (simulating the average tailpipe emissions after a cold start)
  - Type II: (carbon monoxide emission at idling speed)
  - Type III: (emission of crankcase gases)
  - Type IV: (evaporation emissions)

<sup>(1)</sup> OJ No L 96, 3. 4. 1985, p. 25.



▼ **M10**

— Type V: (durability of anti-pollution devices).

5.2.2. Compression ignition engined vehicles must be subject to the following tests:

— Type I: (simulating the average tailpipe emissions after a cold start)

— Type V: (durability of anti-pollution devices).

▼ **M9**

5.3. **Description of tests**

5.3.1. Type I test (simulating the average tailpipe emissions after a cold start).

5.3.1.1. Figure I.5.3 illustrates the routes for type I test. This test must be carried out on all vehicles referred to in section 1, of a maximum mass not exceeding 3,5 tonnes.

5.3.1.2. The vehicle is placed on a chassis dynamometer equipped with a means of load and inertia simulation.

► **M10** 5.3.1.2.1. A test lasting a total of ◀ vehicles referred to in 8.1, a test lasting a total of 19 minutes and 40 seconds, made up of two parts, One and Two, is performed without interruption. An unsampled period of not more than 20 seconds may, with the agreement of the manufacturer, be introduced between the end of Part One and the beginning of Part Two in order to facilitate adjustment of the test equipment.

5.3.1.2.2. Part One of the test is made up of four elementary urban cycles. Each elementary urban cycle comprises fifteen phases (idling, acceleration, steady speed, deceleration, etc.).

5.3.1.2.3. Part Two of the test is made up of one extra urban cycle. The extra urban cycle comprises 13 phases (idling, acceleration, steady speed, deceleration, etc.).

▼ **M10**

Figure 1.5.2

**Different routes for type-approval and extensions**

Type-approval test	Positive-ignition engined vehicles of categories M and N	Compression ignition engined vehicles of categories M <sub>1</sub> and N <sub>1</sub>
Type I	Yes (► <b>M12</b> maximum mass ◀ ≤ 3,5 t)	Yes (► <b>M12</b> maximum mass ◀ ≤ 3,5 t)
Type II	Yes (► <b>M12</b> maximum mass ◀ > 3,5 t)	—
Type III	Yes	—
Type IV	Yes (► <b>M12</b> maximum mass ◀ ≤ 3,5 t)	—
Type V	Yes (► <b>M12</b> maximum mass ◀ ≤ 3,5 t)	Yes (► <b>M12</b> maximum mass ◀ ≤ 3,5 t)
Extension conditions	Section 6	— Section 6 — M <sub>2</sub> and N <sub>2</sub> with reference ► <b>M12</b> maximum mass ◀ not more than 2 840 kg

▼ **M10**▼ **M9**

5.3.1.2.5. During the test the exhaust gases are diluted and a proportional sample collected in one or more bags. The exhaust gases of the vehicle tested are diluted, sampled and analyzed, following the procedure described below, and the total volume of the diluted exhaust is measured. Not only the carbon monoxide, hydrocarbon and nitrogen oxide emissions, but also the particulate pollutant emissions from vehicles equipped with compression-ignition engines are recorded.

5.3.1.3. The test is carried out using the procedure described in Annex III. The methods used to collect and analyse the gases and to remove and weigh the particulates must be as prescribed.

5.3.1.4. ► **M12** Subject to the requirements of 5.3.1.5 the test must be repeated three times. ◀ ► **M10** The results are multiplied by ◀ the appropriate deterioration factors obtained from 5.3.5. The resulting masses of gaseous emissions and, in the case of vehicles equipped with compression-ignition engines, the mass of particulates obtained in each test must be less than the limits shown in the table below:

▼ **M13**

Category/class of vehicle		Limit values					
		Reference mass RW (kg)	Mass of carbon monoxide $L_1$ (g/km)		Combined mass of hydrocarbons and oxides of nitrogen $L_2$ (g/km)		Mass of particulates $L_3$ (g/km)
Category	Class		Petrol	Diesel	Petrol	Diesel <sup>(1)</sup>	Diesel <sup>(1)</sup>
M <sup>(2)</sup>	—	all	2,2	1,0	0,5	0,7	0,08
N <sub>1</sub> <sup>(2)</sup>	I	RW ≤ 1 250	2,2	1,0	0,5	0,7	0,08
	II	1 250 < RW ≤ 1 700	4,0	1,25	0,6	1,0	0,12
	III	1 700 < RW	5,0	1,5	0,7	1,2	0,17

<sup>(1)</sup> Until 30 September 1999, for vehicles fitted with diesel engines of the direct injection type, the limit values  $L_2$  and  $L_3$  are the following:

	$L_2$	$L_3$
— category M <sup>(2)</sup> and N <sub>1</sub> <sup>(2)</sup> class I:	0,9	0,10
— category N <sub>1</sub> <sup>(2)</sup> class II:	1,3	0,14
— category N <sub>1</sub> <sup>(2)</sup> class III:	1,6	0,20

<sup>(2)</sup> Except:

- vehicles designed to carry more than six occupants including the driver,
- vehicles whose maximum mass exceed 2 500 kg.

<sup>(3)</sup> And those category M vehicles which are specified in footnote <sup>(2)</sup>.

▼ **M9**

5.3.1.4.1. Notwithstanding the requirements of 5.3.1.4, for each pollutant or combination of pollutants, one of the three resulting masses obtained may exceed, by not more than 10 %, the limit prescribed, provided the arithmetical mean of the three results is below the prescribed limit. Where the prescribed limits are exceeded for more than one pollutant it is immaterial whether this occurs in the same test or in different tests  
► **M12** ◀

▼ **M12**▼ **M9**

5.3.1.5. The number of tests prescribed in 5.3.1.4 is reduced in the conditions hereinafter defined, where  $V_1$  is the result of the first test and  $V_2$  the result of the second test for each pollutant or for the combined emission of two pollutants subject to limitation.

**▼M9**

- 5.3.1.5.1. Only one test is performed if the result obtained for each pollutant or for the combined emission of two pollutants subject to limitation, is less than or equal to 0,70 L (ie.  $V_1 \leq 0,70$  L).
- 5.3.1.5.2. If the requirement of 5.3.1.5.1 is not satisfied, only two tests are performed if, for each pollutant or for the combined emission of two pollutants subject to limitation, the following requirements are met:  
 $V_1 \leq 0,85$  L and  $V_1 + V_2 \leq 1,70$  L and  $V_2 \leq L$ .
- 5.3.2. *Type II test (carbon monoxide emission test at idling speed)*

**▼M10**

- 5.3.2.1. This test is carried out on vehicles powered by a positive-ignition engine to which the test specified in 5.3.1 does not apply.
- 5.3.2.2. When tested in accordance with Annex IV, the carbon monoxide content by volume of the exhaust gases emitted with the engine idling must not exceed 3,5 % at the setting specified by the manufacturer and must not exceed 4,5 % within the range of adjustments specified in that Annex.

**▼M9**

- 5.3.3. *Type III test (verifying emissions of crankcase gases)*
- 5.3.3.1. This test must be carried out on all vehicles referred to in section 1 except those having compression-ignition engines.

▼M12

Figure I.5.3

## Flow chart for the type I type-approval

(see section 5.3.1)

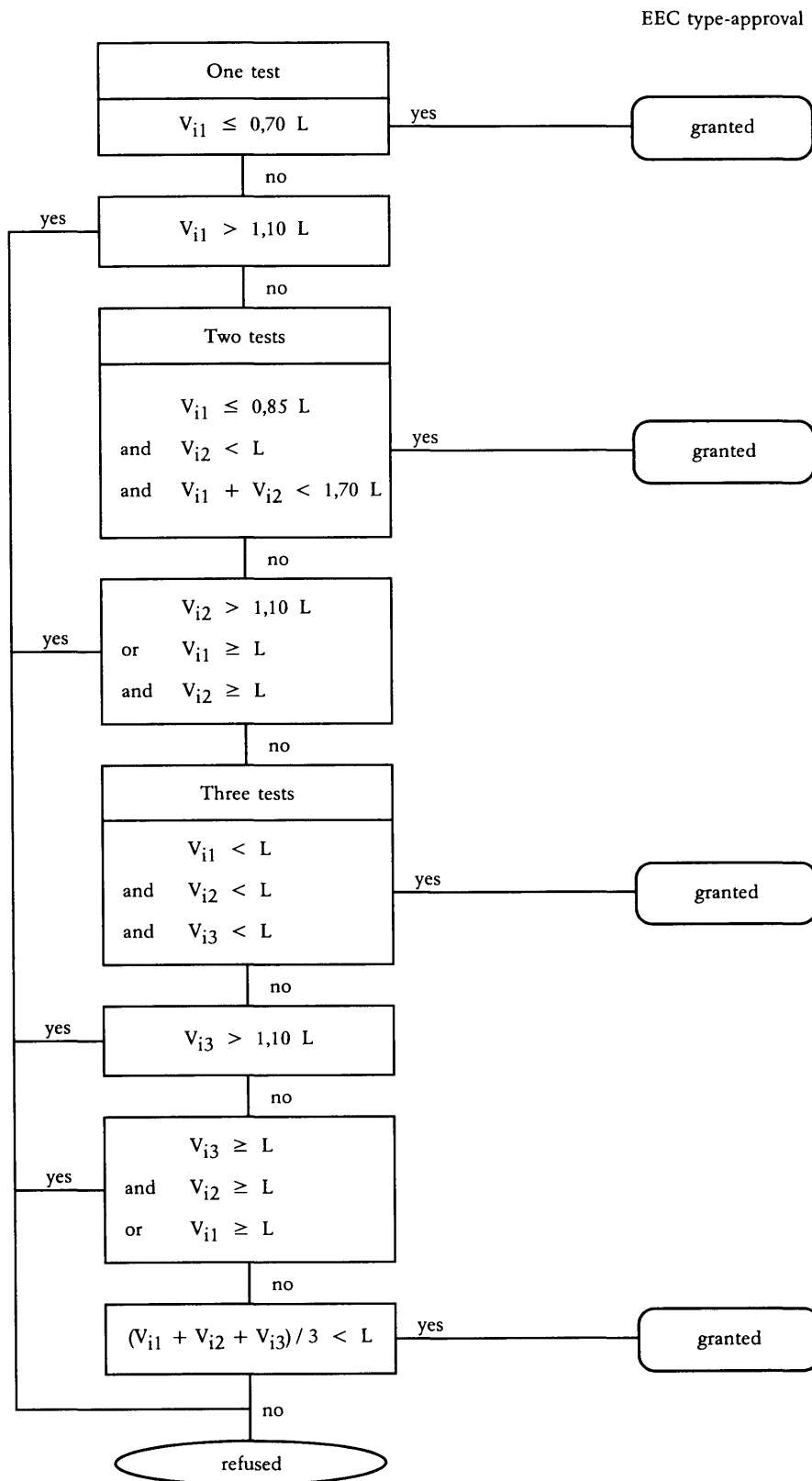

**▼ M9**

5.3.3.2. When tested in accordance with Annex V, the engine's crankcase ventilation system must not permit the emission of any of the crankcase gases into the atmosphere.

5.3.4. *Type IV test (determination of evaporative emissions)*

**▼ M10**

5.3.4.1. This test must be carried out on all vehicles referred to in Section 1 except those vehicles having a compression-ignition engine.

**▼ M9**

5.3.4.2. When tested in accordance with Annex VI, evaporative emissions shall be less than 2 g/test.

5.3.5. *Type V test (durability of anti-pollution devices)*

► **M10** 5.3.5.1. This test must be carried out on all vehicles referred to in Section 1 to which the test specified in 5.3.1 applies' (remainder unchanged). ◀ The test represents an ageing test of 80 000 kilometres driven in accordance with the programme described in Annex VII on a test track, on the road or on a chassis dynamometer.

5.3.5.2. Notwithstanding the requirement of 5.3.5.1 a manufacturer may choose to have the deterioration factors from the following table used as an alternative to testing to 5.3.5.1.1.

Engine category	Deterioration factors		
	CO	HC + NOx	Particulates (1)
Positive-ignition engine	1,2	1,2	—
Compression-ignition engine	1,1	1,0	1,2

(1) For compression ignition engined vehicles.

At the request of the manufacturer, the technical service may carry out the type I test before the type V test has been completed using the deterioration factors in the table above. On completion of the type V test, the technical service may then amend the type-approval results recorded in Annex IX by replacing the deterioration factors in the above table with those measured in the type V test.

5.3.5.3. Deterioration factors are determined using either procedure in 5.3.5.1 or using the values in the table in 5.3.5.2. The factors are used to establish compliance with the requirements of 5.3.1.4 and 7.1.1.1.

**▼ M12**

## 6. MODIFICATIONS OF THE TYPE AND AMENDMENTS TO APPROVALS

In the case of modifications of the type approved pursuant to this Directive, the provisions of Article 5 of Directive 70/156/EEC and, if applicable, the following special provisions shall apply:

**▼ M9**

6.1. **Tailpipe emission related extensions**  
(type I and type II tests).

**▼ M10**

6.1.1. *Vehicle types of different reference masses*

**▼ M12**

6.1.1.1. Approval granted to a vehicle type may be extended only to vehicle types of a reference mass requiring the use of the next two higher equivalent inertia or any lower equivalent inertia.

**▼ M10**

6.1.1.2. In the case of vehicles of category N<sub>1</sub> and vehicles of category M referred to in note 2 of Section 5.3.1.4, if the reference mass of the vehicle type for which extension of the approval is requested requires the use of a flywheel of equivalent inertia lower than that used for the vehicle type already approved, extension of the approval is granted if the masses of the pollutants obtained from

▼ **M10**

the vehicle already approved are within the limits prescribed for the vehicle for which extension of the approval is requested

▼ **M9**6.1.2. *Vehicle types with different overall gear ratios*

Approval granted to a vehicle type may under the following conditions be extended to vehicle types which differ from the type approved only in respect of their transmission ratios:

- 6.1.2.1. For each of the transmission ratios used in the type I test, it is necessary to determine the proportion,

$$E = \frac{V_2 - V_1}{V_1}$$

where, at an engine speed of 1 000 rpm,  $V_1$  is the speed of the vehicle-type approved and  $V_2$  is the speed of the vehicle type for which extension of the approval is requested.

- 6.1.2.2. If, for each gear ratio,  $E \leq 8 \%$ , the extension is granted without repeating the type I tests.

- 6.1.2.3. If, for at least one gear ratio,  $E > 8 \%$  and if for each gear ratio  $E \leq 13 \%$  the type I test must be repeated, but may be performed in a laboratory chosen by the manufacturer ► **M12** subject to the approval of the technical service. ◀ The report of the tests must be sent to the technical service responsible for the type-approval tests.

6.1.3. *Vehicle types of different reference masses and different overall transmission ratios*

Approval granted to a vehicle type may be extended to vehicle types differing from the approved type only in respect of their reference mass and their overall transmission ratios, provided that all the conditions prescribed in 6.1.1 and 6.1.2 are fulfilled.

6.1.4. *Note:*

When a vehicle type has been approved in accordance with 6.1.1 to 6.1.3, such approval may not be extended to other vehicle types.

6.2. **Evaporative emissions (type IV test)**

- 6.2.1. Approval granted to a vehicle type equipped with a control system for evaporative emissions may be extended under the following conditions:

- 6.2.1.1. The basic principle of fuel/air metering (e.g. single point injection, carburettor) must be the same.

- 6.2.1.2. The shape of the fuel tank and the material of the fuel tank and liquid fuel hoses must be identical. The worst-case family with regard to the cross-section and approximate hose length must be tested. Whether non-identical vapour/liquid separators are acceptable is decided by the technical service responsible for the type-approval tests. The fuel tank volume must be within a range of  $\pm 10 \%$ . The setting of the tank relief valve must be identical.

- 6.2.1.3. The method of storage of the fuel vapour must be identical, i.e. trap form and volume, storage medium, air cleaner (if used for evaporative emission control), etc.

- 6.2.1.4. The carburettor bowl fuel volume must be within a 10 millilitre range.

- 6.2.1.5. The method of purging of the stored vapour must be identical (e.g. air flow, start point or purge volume over driving cycle).

- 6.2.1.6. The method of sealing and venting of the fuel metering system must be identical.

## 6.2.2. Further notes:

- (i) different engine sizes are allowed;
- (ii) different engine powers are allowed;
- (iii) automatic and manual gearboxes, two and four wheel transmissions are allowed;
- (iv) different body styles are allowed;
- (v) different wheel and tyre sizes are allowed.

**▼ M9**6.3. **Durability of anti-pollution devices**  
(type V test)

6.3.1. Approval granted to a vehicle type may be extended to different vehicle types, provided that the engine/pollution control system combination is identical to that of the vehicle already approved. To this end, those vehicle types whose parameters described below are identical or remain within the limit values prescribed are considered to belong to the same engine/pollution control system combination.

## 6.3.1.1. Engine:

- number of cylinders,
- engine capacity ( $\pm 15\%$ ),
- configuration of the cylinder block,
- number of valves,
- fuel system,
- type of cooling system,
- combustion process,

**▼ M12**

- cylinder bore centre to centre dimensions.

**▼ M9**

## 6.3.1.2. Pollution control system:

- Catalytic converters:
  - number of catalytic converters and elements,

**▼ M12**

- size and shape of catalytic converters (volume of monolith  $\pm 10\%$ ),

**▼ M9**

- type of catalytic activity (oxidizing, three-way, ...),
- precious metal load (identical or higher),
- precious metal ratio ( $\pm 15\%$ ),
- substrate (structure and material),
- cell density,
- type of casing for the catalytic converter(s),
- location of catalytic converters (position and dimension in the exhaust system, that does not produce a temperature variation of more than 50 K at the inlet of the catalytic converter). ► **M12** This temperature variation shall be checked under stabilized conditions at a speed of 120 km/h and the load setting of type I test. ◀
- Air injection:
  - with or without
  - type (pulsair, air pumps, ...).
- EGR:
  - with or without.

**▼ M12**

6.3.1.3. Inertia category: the two inertia categories immediately above and any inertia category below.

**▼ M9**

6.3.1.4. The durability test may be achieved by using a vehicle, the body style, gear box (automatic or manual) and size of the wheels or tyres of which are different from those of the vehicle type for which the type approval is sought.

**▼ M11**

## 7. CONFORMITY OF PRODUCTION

7.1. Measures to ensure the conformity of production must be taken in accordance with the provisions of Article 10 of Directive 70/156/EEC.

Conformity of production is checked on the basis of the description in the type-approval certificate set out in Annex IX to this Directive.

If the authority is not satisfied with the auditing procedure of the manufacturer, then Sections 2.4.2 and 2.4.3 of Annex X to Directive 70/156/EEC are applicable.

**▼ M12**

- 7.1.1. If a type I test is to be carried out and a vehicle type-approval has one or several extensions, the tests will be carried out either on the vehicle described in the initial information package or on the vehicle described in the information package relating to the relevant extension.

**▼ M11**

- 7.1.1.1. *Checking the conformity of the vehicle for a type I test.*  
After selection by the authority, the manufacturer must not undertake any adjustment to the vehicles selected.
- 7.1.1.1.1. Three vehicles are selected at random in the series and are tested as described in Section 5.3.1 of this Annex. The deterioration factors are used in the same way. The limit values are given in Section 5.3.1.4 of this Annex.
- 7.1.1.1.2. If the authority is satisfied with the production standard deviation given by the manufacturer in accordance with Annex X to Directive 70/156/EEC, the tests are carried out according to Appendix 1 of this Annex.  
  
If the authority is not satisfied with the production standard deviation given by the manufacturer in accordance with Annex X to Directive 70/156/EEC, the tests are carried out according to Appendix 2 of this Annex.
- 7.1.1.1.3. The production of a series is deemed to conform or not to conform on the basis of a sampling test of the vehicles once a pass decision is reached for all the pollutants or a fail decision is reached for one pollutant, according to the test criteria applied in the appropriate appendix.  
  
When a pass decision has been reached for one pollutant, that decision will not be changed by any additional tests carried out to reach a decision for the other pollutants.  
  
If no pass decision is reached for all the pollutants and no fail decision is reached for one pollutant, a test is carried out on another vehicle (see Figure I/7).
- 7.1.1.2. Notwithstanding the requirements of Section 3.1.1 of Annex III, the tests will be carried out on vehicles coming straight off the production line.
- 7.1.1.2.1. However, at the request of the manufacturer, the tests may be carried out on vehicles which have completed:  
— a maximum of 3 000 km for vehicles equipped with a positive ignition engine,  
— a maximum of 15 000 km for vehicles equipped with a compression ignition engine,  
  
In both these cases, the running-in procedure will be conducted by the manufacturer, who must undertake not to make any adjustments to these vehicles.



▼M11

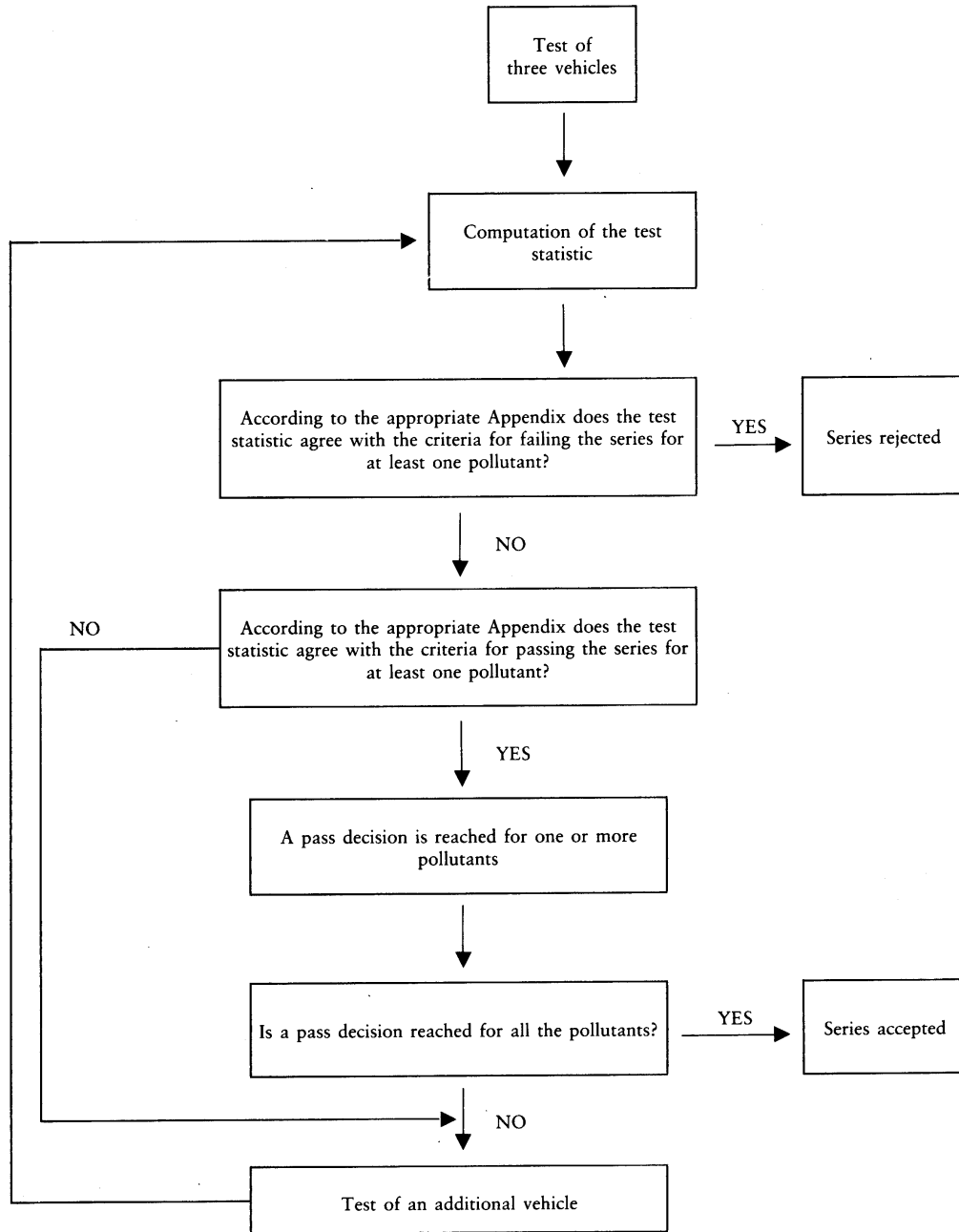

Figure I.7

**▼ M11**

- 7.1.1.2.2. If the manufacturer wishes to run in the vehicles, ('x' km, where  $x \leq 3\,000$  km for vehicles equipped with a positive ignition engine and  $x \leq 15\,000$  km for vehicles equipped with a compression ignition engine), the procedure will be as follows:
- the pollutant emissions (type I) will be measured at zero and at 'x' km on the first tested vehicle,
  - the evolution coefficient of the emissions between zero and 'x' km will be calculated for each of the pollutants:

$$\frac{\text{Emissions 'x' km}}{\text{Emissions zero km}}$$

This may be less than 1,

- the other vehicles will not be run in, but their zero km emissions will be multiplied by the evolution coefficient.  
In this case, the values to be taken will be:
    - the values at 'x' km for the first vehicle,
    - the values at zero km multiplied by the evolution coefficient for the other vehicles.
- 7.1.1.2.3. All these tests may be conducted with commercial fuel. However, at the manufacturer's request, the reference fuels described in Annex VIII may be used.
- 7.1.2. If a type III test is to be carried out, it must be conducted on all vehicles selected for the type I COP test (7.1.1.1.1). The conditions laid down in 5.3.3.2 must be complied with.
- 7.1.3. If a type IV test is to be carried out, it must be conducted in accordance with Section 7 of Annex VI.

**▼ M9**

8. TRANSITIONAL PROVISIONS

**▼ M10****▼ M9**

- 8.2. The following provisions remain applicable until 31 December 1994 for vehicles newly put into service and type-approved before 1 July 1993:
- the transitional provisions laid down in section 8.3 (with the exception of 8.3.1.3) of Annex I to Directive 70/220/EEC, as amended by Directive 88/436/EEC,
  - **M10** — the provisions laid down for category  $M_1^{(1)}$  vehicles fitted with positive-ignition engines of a capacity of more than 2 litres, in Annex I to Directive 70/220/EEC as amended by Directive 88/76/EEC, ◀
  - the provisions laid down for vehicles with an engine capacity of less than 1,4 litres in Directive 70/220/EEC, as amended by Directive 89/458/EEC.

At the manufacturer's request, the tests carried out in accordance with these requirements may be type-approved instead of undergoing the test referred to in sections 5.3.1, 5.3.5 and 7.1.1 of Annex I to Directive 70/220/EEC, as amended by Directive 91/441/EEC.

- 8.3. ► **M10** For vehicles of category  $M_1^{(1)}$  up to 1 July 1994 for type-approval and up to 31 December 1994 for the initial entry into service, and
- for vehicles of category  $N_1^{(2)}$  up to 1 October 1994 for type-approval and up to 1 October 1995 for the initial entry into service,
- the limit values for the combined mass of hydrocarbons and nitrogen oxides and for the mass of particulates of vehicles fitted with compression ignition engines of the direct-injection type are those obtained by multiplying the values  $L_2$  and  $L_3$  in the tables in 5.3.1.4 (type-approval) and 7.1.1.1 (conformity check) by a factor of 1,4. ◀

<sup>(1)</sup> See note <sup>(2)</sup> of Section 5.3.1.4.

<sup>(2)</sup> See note <sup>(3)</sup> of Section 5.3.1.4.

▼ **M11***Appendix 1*

1. This Appendix describes the procedure to be used to verify the production conformity for the type I test when the manufacturer's production standard deviation is satisfactory.
2. With a minimum sample size of 3, the sampling procedure is set so that the probability of a lot passing a test with 40 % of the production defective is 0,95 (producer's risk = 5 %) while the probability of a lot being accepted with 65 % of the production defective is 0,1 (consumer's risk = 10 %).
3. For each of the pollutants given in Section 5.3.1.4 of Annex I, the following procedure is used (see Figure I.7).

Taking:

- L = the natural logarithm of the limit value for the pollutant,  
 $x_i$  = the natural logarithm of the measurement for the i-th vehicle of the sample,  
s = an estimate of the production standard deviation (after taking the natural logarithm of the measurements),  
n = the current sample number.

4. Compute for the sample the test statistic quantifying the sum of the standard deviations from the limit and defined as:

$$\frac{1}{s} \sum_{i=1}^n (L - x_i)$$

5. Then:

- if the test statistic is greater than the pass decision number for the sample size given in Table (I.1.5), the pollutant is passed,
- if the test statistic is less than the fail decision number for the sample size given in Table (I.1.5), the pollutant is failed; otherwise, an additional vehicle is tested according to Section 7.1.1.1 of Annex I and the calculation reapplied to the sample with a sample size one unit greater.

TABLE I.1.5

Cumulative number of tested vehicles (current sample size)	Pass decision threshold	Fail decision threshold
3	3,327	-4,724
4	3,261	-4,790
5	3,195	-4,856
6	3,129	-4,922
7	3,063	-4,988
8	2,997	-5,054
9	2,931	-5,120
10	2,865	-5,185
11	2,799	-5,251
12	2,733	-5,317
13	2,667	-5,383
14	2,601	-5,449
15	2,535	-5,515
16	2,469	-5,581
17	2,403	-5,647
18	2,337	-5,713
19	2,271	-5,779
20	2,205	-5,845
21	2,139	-5,911
22	2,073	-5,977
23	2,007	-6,043
24	1,941	-6,109
25	1,875	-6,175
26	1,809	-6,241
27	1,743	-6,307
28	1,677	-6,373
29	1,611	-6,439
30	1,545	-6,505
31	1,479	-6,571
32	-2,112	-2,112

▼ **M11***Appendix 2*

1. This Appendix describes the procedure to be used to verify the production conformity requirements for the type I test when the manufacturer's evidence of production standard deviation is either unsatisfactory or unavailable.
2. With a minimum sample size of 3, the sampling procedure is set so that the probability of a lot passing a test with 40 % of the production defective is 0,95 (producer's risk = 5 %) while the probability of a lot being accepted with 65 % of the production defective is 0,1 (consumer's risk = 10 %).
3. The measurements of the pollutants given in Section 5.3.1.4 of Annex I are considered to be log normally distributed and must first be transformed by taking their natural logarithms. Let  $m_0$  and  $m$  denote the minimum and maximum sample sizes respectively ( $m_0 = 3$  and  $m = 32$ ) and let  $n$  denote the current sample number.
4. If the natural logarithms of the measurements in the series are  $x_1, x_2, \dots, x_j$  and  $L$  is the natural logarithm of the limit value for the pollutant, then define:

$$d_j = x_j - L$$

$$\bar{d}_n = \frac{1}{n} \sum_{j=1}^n d_j$$

$$v_n^2 = \frac{1}{n} \sum_{j=1}^n (d_j - \bar{d}_n)^2$$

5. Table I.2.5 shows values of the pass ( $A_n$ ) and fail ( $B_n$ ) decision numbers against current sample number. The test statistic is the ratio  $\bar{d}_n/v_n$  and must be used to determine whether the series has passed or failed as follows:

For  $m_0 \leq n \leq m$ :

- pass the series if  $\bar{d}_n/v_n \leq A_n$ ,
- fail the series if  $\bar{d}_n/v_n \geq B_n$ ,
- take another measurement if  $A_n < \bar{d}_n/v_n < B_n$ .

6. *Remarks*

The following recursive formulae are useful for computing successive values of the test statistic:

$$\bar{d}_n = \left(1 - \frac{1}{n}\right) \bar{d}_{n-1} + \frac{1}{n} d_n$$

$$v_n^2 = \left(1 - \frac{1}{n}\right) v_{n-1}^2 + \frac{(\bar{d}_n - d_n)^2}{n-1}$$

$$(n = 2, 3, \dots; \bar{d}_1 = d_1; v_1 = 0)$$

▼ **M11**

TABLE I.2.5  
Minimum sample size = 3

Sample size $n$	Pass decision threshold $A_n$	Fail decision threshold $B_n$
3	-0,80381	16,64743
4	-0,76339	7,68627
5	-0,72982	4,67136
6	-0,69962	3,25573
7	-0,67129	2,45431
8	-0,64406	1,94369
9	-0,61750	1,59105
10	-0,59135	1,33295
11	-0,56542	1,13566
12	-0,53960	0,97970
13	-0,51379	0,85307
14	-0,48791	0,74801
15	-0,46191	0,65928
16	-0,43573	0,58321
17	-0,40933	0,51718
18	-0,38266	0,45922
19	-0,35570	0,40788
20	-0,32840	0,36203
21	-0,30072	0,32078
22	-0,27263	0,28343
23	-0,24410	0,24943
24	-0,21509	0,21831
25	-0,18557	0,18970
26	-0,15550	0,16328
27	-0,12483	0,13880
28	-0,09354	0,11603
29	-0,06159	0,09480
30	-0,02892	0,07493
31	0,00449	0,05629
32	0,03876	0,03876

▼M12

## ANNEX II

## INFORMATION DOCUMENT No ...

**pursuant to Annex I of Directive 70/156/EEC (\*) relating to EEC type-approval of a vehicle with respect to the measures to be taken against air pollution by emissions from motor vehicles (Directive 70/220/EEC, as last amended by Directive .../.../EC)**

The following information, if applicable, must be supplied in triplicate and include a list of contents. Any drawings must be supplied in appropriate scale and in sufficient detail on size A4 or on a folder of A4 format. Photographs, if any, must show sufficient detail.

If the systems, components or separate technical units have electronic controls, information concerning their performance must be supplied.

- 0. GENERAL
  - 0.1. Make (trade name of manufacturer): .....
  - 0.2. Type and general commercial description(s): .....
  - 0.3. Means of identification of type, if marked on the vehicle (b): .....
  - 0.3.1. Location of that marking: .....
  - 0.4. Category of vehicle (c): .....
  - 0.5. Name and address of manufacturer: .....
  - 0.8. Address(es) of assembly plant(s): .....
- 1. GENERAL CONSTRUCTION CHARACTERISTICS OF THE VEHICLE
  - 1.1. Photographs and/or drawings of a representative vehicle: .....
  - 1.3.3. Powered axles (numbers, position, interconnection): .....
- 2. MASSES AND DIMENSION (e) (in kg and mm)  
(Refer to drawing where applicable)
  - 2.6. Mass of vehicle with bodywork in running order, or mass of the chassis with cab if the manufacturer does not fit the bodywork (with standard equipment, including coolant, oils, fuel, tools, spare wheel and driver) (e) (maximum and minimum): .....
  - 2.8. Technically permissible maximum laden mass stated by the manufacturer (f) (maximum and minimum): .....
- 3. POWER PLANT (g)
  - 3.1. Manufacturer: .....
  - 3.1.1. Manufacturer's engine code (As marked on the engine, or other means of identification): ....
  - 3.2. Internal combustion engine
    - 3.2.1.1. Working principle: positive ignition/compression ignition, four stroke/two stroke (h)

(\*) The item numbers and footnotes used in this information document correspond to those set out in Annex I to Directive 70/156/EEC. Items not relevant for the purpose of this Directive are omitted.

▼ **M12**

- 3.2.1.2. Number and arrangements of cylinders: .....
- 3.2.1.2.1. Bore (°): ..... mm
- 3.2.1.2.2. Stroke (°): ..... mm
- 3.2.1.2.3. Firing order: .....
- 3.2.1.3. Engine capacity (°): ..... cm<sup>3</sup>
- 3.2.1.4. Volumetric compression ratio (°): .....
- 3.2.1.5. Drawings of combustion chamber, piston crown and, in the case of positive ignition engine, piston rings: .....
- 3.2.1.6. Idling speed (°): ..... min<sup>-1</sup>
- 3.2.1.7. Carbon monoxide content by volume in the exhaust gas with the engine idling (°): ..... % as stated by the manufacturer (positive ignition engines only)
- 3.2.1.8. Maximum net power (°): ..... kW at ..... min<sup>-1</sup> (manufacturer's declared value)
- 3.2.2. Fuel: diesel oil/petrol/LPG/any other (°)
- 3.2.2.1. RON, leaded: .....
- 3.2.2.2. RON, unleaded: .....
- 3.2.2.3. Fuel tank inlet: restricted orifice/label (°)
- 3.2.4. Fuel feed
- 3.2.4.1. By carburettor(s): yes/no (°)
- 3.2.4.1.1. Make(s): .....
- 3.2.4.1.2. Type(s): .....
- 3.2.4.1.3. Number fitted: .....
- 3.2.4.1.4. Adjustments (°):
- 3.2.4.1.4.1. Jets: .....
- 3.2.4.1.4.2. Venturis: .....
- 3.2.4.1.4.3. Float-chamber level: .....
- 3.2.4.1.4.4. Mass of float: .....
- 3.2.4.1.4.5. Float needle: .....
- 3.2.4.1.5. Cold start system: manual/automatic (°)
- 3.2.4.1.5.1. Operating principle(s): .....
- 3.2.4.1.5.2. Operating limits/settings (°) (°): .....
- 3.2.4.2. By fuel injection (compression ignition only): yes/no (°)
- 3.2.4.2.1. System description: .....
- 3.2.4.2.2. Working principle: direct injection/pre-chamber/swirl chamber (°)
- 3.2.4.2.3. Injection pump
- 3.2.4.2.3.1. Make(s): .....
- 3.2.4.2.3.2. Type(s): .....
- 3.2.4.2.3.3. Maximum fuel delivery (°) (°): ..... mm<sup>3</sup>/stroke or cycle at a pump speed of: ..... min<sup>-1</sup> or, alternatively, a characteristic diagram: .....
- 3.2.4.2.3.4. Injection timing (°): .....
- 3.2.4.2.3.5. Injection advance curve (°): .....
- 3.2.4.2.3.6. Calibration procedure: test bench/engine (°)
- 3.2.4.2.4. Governor

Or the curve of fuel delivery plotted against the air flow and settings required to keep to the curve

▼ **M12**

- 3.2.4.2.4.1. Type: .....
- 3.2.4.2.4.2. Cut-off point
- 3.2.4.2.4.2.1. Cut-off point under load: ..... min<sup>-1</sup>
- 3.2.4.2.4.2.2. Cut-off point without load: ..... min<sup>-1</sup>
- 3.2.4.2.6. Injector(s)
- 3.2.4.2.6.1. Make(s): .....
- 3.2.4.2.6.2. Type(s): .....
- 3.2.4.2.6.3. Opening pressure <sup>(?)</sup>: ..... kPa or characteristic diagram <sup>(?)</sup>: .....
- 3.2.4.2.7. Cold start system
- 3.2.4.2.7.1. Make(s): .....
- 3.2.4.2.7.2. Type(s): .....
- 3.2.4.2.7.3. Description: .....
- 3.2.4.2.8. Auxiliary starting aid
- 3.2.4.2.8.1. Make(s): .....
- 3.2.4.2.8.2. Type(s): .....
- 3.2.4.2.8.3. System description: .....
- 3.2.4.3. By fuel injection (positive ignition only): yes/no (!)
- 3.2.4.3.1. Working principle: Intake manifold (single-/multi-point (!))/direct injection/other (specify) (!):  
.....
- 3.2.4.3.2. Make(s): .....
- 3.2.4.3.3. Type(s): .....
- 3.2.4.3.4. System description:
- 3.2.4.3.4.1. Type or number of the control unit: .....
- 3.2.4.3.4.2. Type of fuel regulator: .....
- 3.2.4.3.4.3. Type of air-flow sensor: .....
- 3.2.4.3.4.4. Type of fuel distributor: .....
- 3.2.4.3.4.5. Type of pressure regulator: .....
- 3.2.4.3.4.6. Type of microswitch: .....
- 3.2.4.3.4.7. Type of idling adjustment screw: .....
- 3.2.4.3.4.8. Type of throttle housing: .....
- 3.2.4.3.4.9. Type of water temperature sensor: .....
- 3.2.4.3.4.10. Type of air temperature sensor: .....
- 3.2.4.3.4.11. Type of temperature switch: .....
- 3.2.4.3.5. Injectors: opening pressure <sup>(?)</sup>: ..... kPa or characteristic diagram <sup>(?)</sup>: .....
- 3.2.4.3.6. Injection timing: .....
- 3.2.4.3.7. Cold start system
- 3.2.4.3.7.1. Operating principle(s): .....
- 3.2.4.3.7.2. Operating limits/settings <sup>(!)</sup> <sup>(?)</sup>: .....
- 3.2.4.4. Feed pump
- 3.2.4.4.1. Pressure <sup>(?)</sup>: ..... kPa or characteristic diagram <sup>(?)</sup>: .....
- 3.2.6. Ignition
- 3.2.6.1. Make(s): .....

In the case of systems other than  
continuous injection give equivalent  
details



▼ M12

- 3.2.6.2. Type(s): .....
- 3.2.6.3. Working principle: .....
- 3.2.6.4. Ignition advance curve (?): .....
- 3.2.6.5. Static ignition timing (?): ..... degrees before TDC
- 3.2.6.6. Contact-point gap (?): ..... mm
- 3.2.6.7. Dwell-angle (?): ..... degrees
- 3.2.7. Cooling system (liquid/air) (!)
- 3.2.8. Intake system
- 3.2.8.1. Pressure charger: yes/no (!)
- 3.2.8.1.1. Make(s): .....
- 3.2.8.1.2. Type(s): .....
- 3.2.8.1.3. Description of the system (e.g. maximum charge pressure: ..... kPa, wastegate if applicable):  
.....
- 3.2.8.2. Intercooler: yes/no (!)
- 3.2.8.4. Description and drawings of the inlet pipes and their accessories (plenum chamber, heating device, additional air intakes, etc.): .....
- 3.2.8.4.1. Intake manifold description (include drawings and/or photos): .....
- 3.2.8.4.2. Air filter, drawings: ....., or
- 3.2.8.4.2.1. Make(s): .....
- 3.2.8.4.2.2. Type(s): .....
- 3.2.8.4.3. Intake silencer, drawings: ....., or
- 3.2.8.4.3.1. Make(s): .....
- 3.2.8.4.3.2. Type(s): .....
- 3.2.9. Exhaust system
- 3.2.9.2. Description and/or drawing of the exhaust system: .....
- 3.2.11. Valve timing or equivalent data
- 3.2.11.1. Maximum lift of valve, angles of opening and closing, or timing details of alternative distribution system, in relation to dead centres: .....
- 3.2.11.2. Reference and/or setting ranges (!): .....
- 3.2.12. Measures taken against air pollution
- 3.2.12.1. Device for recycling crankcase gases (description and drawings): .....
- 3.2.12.2. Additional anti-pollution devices (if any, and if not covered by another heading)
- 3.2.12.2.1. Catalytic converter: yes/no (!)
- 3.2.12.2.1.1. Number of catalytic converters and elements: .....
- 3.2.12.2.1.2. Dimensions, shape and volume of the catalytic converter(s): .....
- 3.2.12.2.1.3. Type of catalytic action: .....
- 3.2.12.2.1.4. Total charge of precious metals: .....
- 3.2.12.2.1.5. Relative concentration: .....
- 3.2.12.2.1.6. Substrate (structure and material): .....
- 3.2.12.2.1.7. Cell density: .....
- 3.2.12.2.1.8. Type of casing for the catalytic converter(s): .....
- 3.2.12.2.1.9. Location of the catalytic converter(s) (place and reference distance in the exhaust line): .....

▼ **M12**

- 3.2.12.2.1.10. Heat shield: yes/no (\*)
- 3.2.12.2.2. Oxygen sensor: yes/no (\*)
- 3.2.12.2.2.1. Type: .....
- 3.2.12.2.2.2. Location: .....
- 3.2.12.2.2.3. Control range: .....
- 3.2.12.2.3. Air injection: yes/no (\*)
- 3.2.12.2.3.1. Type (pulse air, air pump etc): .....
- 3.2.12.2.4. Exhaust gas recirculation: yes/no (\*)
- 3.2.12.2.4.1. Characteristics (flow rate etc): .....
- 3.2.12.2.5. Evaporative emissions control system: yes/no (\*)
- 3.2.12.2.5.1. Detailed description of the devices and their state of tune: .....
- 3.2.12.2.5.2. Drawing of the evaporative control system: .....
- 3.2.12.2.5.3. Drawing of the carbon canister: .....
- 3.2.12.2.5.4. Mass of dry charcoal: ..... g
- 3.2.12.2.5.5. Schematic drawing of the fuel tank with indication of capacity and material: .....
- 3.2.12.2.5.6. Drawing of the heat shield between tank and exhaust system: .....
- 3.2.12.2.6. Particulate trap: yes/no (\*)
- 3.2.12.2.6.1. Dimensions, shape and capacity of the particulate trap: .....
- 3.2.12.2.6.2. Type and design of the particulate trap: .....
- 3.2.12.2.6.3. Location (reference distance in the exhaust line): .....
- 3.2.12.2.6.4. Method or system of regeneration, description and/or drawing: .....
- 3.2.12.2.7. Other systems (description and operation): .....
4. TRANSMISSION (\*)
- 4.4. Clutch (type): .....
- 4.4.1. Maximum torque conversion: .....
- 4.5. Gearbox
- 4.5.1. Type (manual/automatic/CVT (\*)): .....
- 4.6. Gear ratios

Gear	Internal gearbox ratios (ratios of engine to gearbox output shaft revolutions)	Final drive ratio(s) (ratio of gearbox output shaft to driven wheel revolutions)	Total gear ratios
Maximum for CVT (*)			
1			
2			
3			
...			
Minimum for CVT (*)			
Reverse			

(\*) Continuously variable transmission

▼ M12

6. SUSPENSION
- 6.6. Tyres and wheels
- 6.6.1. Tyre / wheel combination(s) (for tyres indicate size designation, minimum load-capacity index, minimum speed category symbol; for wheels indicate rim size(s) and off-set(s))
- 6.6.1.1. Axles
- 6.6.1.1.1. Axle 1: .....
- 6.6.1.1.2. Axle 2: .....
- 6.6.1.1.3. Axle 3: .....
- 6.6.1.1.4. Axle 4: .....
- etc.
- 6.6.2. Upper and lower limits of rolling radii
- 6.6.2.1. Axle 1: .....
- 6.6.2.2. Axle 2: .....
- 6.6.2.3. Axle 3: .....
- 6.6.2.4. Axle 4: .....
- etc.
- 6.6.3. Tyre pressure(s) as recommended by the vehicle manufacturer: ..... kPa
9. BODYWORK
- 9.10.3. Seats
- 9.10.3.1. Number: .....

Date, file

▼ M12

*Appendix*

INFORMATION ON TEST CONDITIONS

1. **Spark plugs**
  - 1.1. Make: .....
  - 1.2. Type: .....
  - 1.3. Spark-gap setting: .....
2. **Ignition coil**
  - 2.1. Make: .....
  - 2.2. Type: .....
3. **Ignition condenser**
  - 3.1. Make: .....
  - 3.2. Type: .....
4. **Lubricant used**
  - 4.1. Make: .....
  - 4.2. Type: .....

**▼ M9***ANNEX III***TYPE I TEST****(Verifying the average emission of tailpipe emissions after a cold start)**

## 1. INTRODUCTION

This Annex describes the procedure for the Type I test defined in 5.3.1 of Annex I.

## 2. OPERATING CYCLE ON THE CHASSIS DYNAMOMETER

2.1. **Description of the cycle**

The operating cycle on the chassis dynamometer is described in Appendix 1 to this Annex.

2.2. **General conditions under which the cycle is carried out**

Preliminary testing cycles must be carried out if necessary to determine how best to actuate the accelerator and brake controls so as to achieve a cycle approximating to the theoretical cycle within the prescribed limits.

2.3. **Use of gearbox**

- 2.3.1. If the maximum speed which can be attained in first gear is below 15 km/h, the second, third and fourth gears are used for the elementary urban cycles (Part One) and the second, third, fourth and fifth gears for the extra-urban cycle (Part Two). The second, third and fourth gears may also be used for the urban cycle (Part One) and the second, third, four and fifth gears for the extra-urban cycle (Part Two) when the driving instructions recommend starting in second gear on level ground, or when first gear is therein defined as a gear reserved for cross-country driving, crawling or towing.

**▼ M10**

For vehicles of category M<sup>(1)</sup> with a maximum engine power of no more than 30 kw and a maximum speed not exceeding 130 km/h, the maximum speed of the extra-urban cycle (Part Two) is limited to 90 km/h until 1 July 1994.

For vehicles of category N<sub>1</sub><sup>(2)</sup> with a power-to-weight ratio of no more than 30 kw/t<sup>(3)</sup> and a maximum speed not exceeding 130 km/h, the maximum speed of the extra-urban cycle (Part Two) is limited to 90 km/h until 1 January 1996 for vehicles of category I and until 1 January 1997 for vehicles of categories II and III.

After these dates, vehicles which do not attain the acceleration and maximum speed values required in the operating cycle must be operated with the accelerator control fully depressed until they once again reach the required operating curve. Deviations from the operating cycle must be recorded in the test report.

**▼ M9**

- 2.3.2. Vehicles equipped with semi-automatic-gearboxes are tested by using the gears normally employed for driving, and the gear is used in accordance with the manufacturer's instructions.

- 2.3.3. Vehicles equipped with automatic gearboxes are tested with the highest gear (drive) engaged. The accelerator must be used in such a way as to obtain the steadiest acceleration possible, enabling the various gears to be engaged in the normal order. Furthermore, the gear-change points shown in Appendix 1 to this Annex do not apply; acceleration must continue throughout the period represented by the straight line connecting the end of each period of idling with the beginning of the next following period of steady speed. The tolerances given in 2.4 apply.

<sup>(1)</sup> See note 2 of Section 5.3.1.4 of Annex I.

<sup>(2)</sup> See note 3 of Section 5.3.1.4 of Annex I.

<sup>(3)</sup> Technically permissible laden mass as stated by the manufacturer.

**▼ M9**

2.3.4. Vehicles equipped with an overdrive which the driver can activate are tested with the overdrive out of action for the urban cycle (Part One) and with the overdrive in action for the extra-urban cycle (Part Two).

2.4. **Tolerances**

2.4.1. A tolerance of  $\pm 2$  km/h is allowed between the indicated speed and the theoretical speed during acceleration, during steady speed, and during deceleration when the vehicle's brakes are used. If the vehicle decelerates more rapidly without the use of the brakes, only the requirements of 6.5.3 apply. Speed tolerances greater than those prescribed are accepted during phase changes provided that the tolerances are never exceeded for more than 0,5 on any one occasion.

2.4.2. The time tolerances are  $\pm 1,0$  s. The above tolerances apply equally at the beginning and at the end of each gear changing period<sup>(1)</sup> for the urban cycle (Part One) and for the operations Nos 3, 5 and 7 of the extra-urban cycle (Part Two).

2.4.3. The speed and time tolerances are combined as indicated in Appendix 1.

3. **VEHICLE AND FUEL**

3.1. **Test vehicle**

3.1.1. The vehicle must be presented in good mechanical condition. It must have been run-in and driven at least 3 000 kilometres before the test.

3.1.2. The exhaust device must not exhibit any leak likely to reduce the quantity of gas collected, which quantity must be that emerging from the engine.

3.1.3. The tightness of the intake system may be checked to ensure that carburation is not affected by an accidental intake of air.

3.1.4. The settings of the engine and of the vehicle's controls must be those prescribed by the manufacturer. This requirement also applies, in particular, to the settings for idling (rotation speed and carbon monoxide content of the exhaust gases), for the cold start device and for the exhaust gas pollutant emission control system.

3.1.5. The vehicle to be tested, or an equivalent vehicle, must be fitted, if necessary, with a device to permit the measurement of the characteristic parameters necessary for chassis dynamometer setting, in conformity with 4.1.1.

3.1.6. The technical service may verify that the vehicle's performance conforms to that stated by the manufacturer, that it can be used for normal driving and, more particularly, that it is capable of starting when cold and when hot.

3.2. **Fuel**

The appropriate reference fuel as defined in Annex VIII must be used for testing.

4. **TEST EQUIPMENT**

4.1. **Chassis dynamometer**

4.1.1. The dynamometer must be capable of simulating road load within one of the following classifications:

- dynamometer with fixed load curve, i.e. a dynamometer whose physical characteristics provide a fixed load curve shape,
- dynamometer with adjustable load curve, i.e. a dynamometer with at least two road load parameters that can be adjusted to shape the load curve.

<sup>(1)</sup> It should be noted that the time of two seconds allowed includes the time for changing gear and, if necessary, a certain amount of latitude to catch up with the cycle.

▼ **M9**

- 4.1.2. The setting of the dynamometer must not be affected by the lapse of time. It must not produce any vibrations perceptible to the vehicle and likely to impair the vehicle's normal operations.
- 4.1.3. It must be equipped with means to simulate inertia and load. These simulators are connected to the front roller in the case of a two-roller dynamometer.
- 4.1.4. *Accuracy*
- 4.1.4.1. It must be possible to measure and read the indicated load to an accuracy of  $\pm 5\%$ .
- 4.1.4.2. In the case of a dynamometer with a fixed load curve the accuracy of the load setting at 80 km/h must be  $\pm 5\%$ . In the case of a dynamometer with an adjustable load curve, the accuracy of matching dynamometer load to road load ► **M12** must be 5 % at 120, 100, 80, 60 and 40, and 10 % at 20 km/h. ◀ Below this, dynamometer absorption must be positive.
- 4.1.4.3. The total inertia of the rotating parts (including the simulated inertia where applicable) must be known and must be within  $\pm 20$  kilograms of the inertia class for the test.
- 4.1.4.4. The speed of the vehicle must be measured by the speed of rotation of the roller (the front roller in the case of a two roller dynamometer). It must be measured with an accuracy of  $\pm 1$  km/h at speeds above 10 km/h.
- 4.1.5. *Load and inertia setting*
- 4.1.5.1. Dynamometer with fixed load curve: the load simulator must be adjusted to absorb the power exerted on the driving wheels at a steady speed of 80 km/h and the absorbed power at 50 km/h shall be noted. The means by which this load is determined and set are described in Appendix 3.
- 4.1.5.2. Dynamometer with adjustable load curve: the load simulator must be adjusted in order to absorb the power exerted on the driving wheels at steady ► **M12** speeds of 120, 100, 80, 60, 40 and 20 km/h. ◀ The means by which these loads are determined and set are described in Appendix 3.
- 4.1.5.3. *Inertia*
- Dynamometers with electrical inertia simulation must be demonstrated to be equivalent to mechanical inertia systems. The means by which equivalence is established is described in Appendix 4.
- 4.2. **Exhaust-gas sampling system**
- 4.2.1. The exhaust gas sampling system must be able to measure the actual quantities of pollutants emitted in the exhaust gases to be measured. The system to be used is the constant volume sampler (CVS) system. This requires that the vehicle exhaust be continuously diluted with ambient air under controlled conditions. In the constant volume sampler concept of measuring two conditions must be satisfied: the total volume of the mixture of exhaust gases and dilution air must be measured and a continuously proportional sample of the volume must be collected for analysis.
- The quantities of pollutants emitted are determined from the sample concentrations, corrected for the pollutant content of the ambient air and the totalized flow over the test period.
- The particulate pollutant emission level is determined by using suitable filters to collect the particulates from a proportional part flow throughout the test and determining the quantity thereof gravimetrically in accordance with 4.3.2.
- 4.2.2. The flow through the system must be sufficient to eliminate water condensation at all conditions which may occur during a test, as defined in Appendix 5.
- 4.2.3. ► **M12** ————— ◀ Appendix 5 gives examples of three types of constant volume sampler system which satisfy the requirements set out in this Annex.
- 4.2.4. The gas and air mixture must be homogeneous at point  $S_2$  of the sampling probe.
- 4.2.5. The probe must extract a true sample of the diluted exhaust gases.

▼ **M9**

- 4.2.6. The system must be free of gas leaks. The design and materials must be such that the system does not influence the pollutant concentration in the diluted exhaust gas. Should any component (heat exchanger, blower, etc.) change the concentration of any pollutant gas in the diluted gas, the sampling for that pollutant must be carried out before that component if the problem cannot be corrected.

▼ **M12**▼ **M9**

- 4.2.7. If the vehicle being tested is equipped with an exhaust pipe comprising several branches, ► **M12** the connecting tubes must be connected as near as possible to the vehicle but in such a manner so as not to effect the functioning of the vehicle. ◀
- 4.2.8. Static pressure variations at the tailpipe(s) of the vehicle must remain within  $\pm 1,25$  kPa of the static pressure variations measured during the dynamometer driving cycle with no connection to the tailpipe(s). Sampling systems capable of maintaining the static pressure to within  $\pm 0,25$  kPa are used if a written request from a manufacturer to the competent authority issuing the approval substantiates the need for the narrower tolerance. The back-pressure must be measured in the exhaust pipe, as near as possible to its end or in an extension having the same diameter.
- 4.2.9. The various valves used to direct the exhaust gases must be of a quick-adjustment, quick-acting type.
- 4.2.10. The gas samples are collected in sample bags of adequate capacity. These bags must be made of such materials as will not change the pollutant gas by more than  $\pm 2$  % after 20 minutes of storage.

4.3. **Analytical equipment**4.3.1. *Requirements*

- 4.3.1.1. Pollutant gases must be analyzed with the following instruments:

Carbon monoxide (CO) and carbon dioxide (CO<sub>2</sub>) analysis:

The carbon monoxide and carbon dioxide analysers must be of the non-dispersive infra-red (NDIR) absorption type.

Hydrocarbons (HC) analysis — spark-ignition engines:

The hydrocarbons analyser must be of the flame ionization (FID) type calibrated with propane gas expressed equivalent to carbon atoms (C<sub>1</sub>).

Hydrocarbons (HC) analysis — compression-ignition engines:

The hydrocarbons analyser must be of the flame ionization type with detector, valves, pipework, etc, heated to 463 K (190 °C)  $\pm 10$  K (HFID). It must be calibrated with propane gas expressed equivalent to carbon atoms (C<sub>1</sub>).

Nitrogen oxide (NO<sub>x</sub>) analysis:

The nitrogen oxide analyser must be either of the chemiluminescent (CLA) or of the non-dispersive ultraviolet resonance absorption (NDUVR) type, both with an NO<sub>x</sub> — NO converter.

Particulates:

Gravimetric determination of the particulates collected. These particulates are in each case collected by two series-mounted filters in the sample gas flow. The quantity of particulates collected by each pair of filters must be as follows:

- V<sub>ep</sub>: flow through filters
- V<sub>mix</sub>: flow through tunnel
- M: particulates mass (g/km)
- M<sub>limit</sub>: limit mass of particulates (limit mass in force, g/km)
- m: mass of particulates collected by filters (g)
- d: actual distance corresponding to the operating cycle (km)



**▼ M9**

$$M = \frac{V_{\text{mix}} \cdot m}{V_{\text{ep}} \cdot d} \text{ or } m = M \cdot d \cdot \frac{V_{\text{ep}}}{V_{\text{mix}}}$$

The particulates sample rate ( $V_{\text{ep}}/V_{\text{mix}}$ ) will be adjusted so that for  $M = M_{\text{limit}}$ ,  $1 \leq m \leq 5$  mg (when 47 mm diameter filters are used).

The filter surface consist of a material that is hydrophobic and inert towards the components of the exhaust gas (fluorocarbon-coated glass-fibre filters or equivalent).

## 4.3.1.2. Accuracy

The analysers must have a measuring range compatible with the accuracy required to measure the concentrations of the exhaust gas sample pollutants.

**▼ M12**

Measurement error must not exceed  $\pm 2$  % (intrinsic error of analyser) disregarding the true value for the calibration gases. For concentrations of less than 100 ppm the measurement error must not exceed  $\pm 2$  ppm. The ambient air sample must be measured on the same analyser with an appropriate range.

**▼ M9**

Measurement of the particulates collected shall be to a guaranteed accuracy of 1  $\mu\text{g}$ .

**▼ M12**

The microgram balance used to determine the weight of all filters must have an accuracy of 5  $\mu\text{g}$  and readability of 1  $\mu\text{g}$ .

**▼ M9**

## 4.3.1.3. Ice-trap

No gas drying device must be used before the analysers unless shown to have no effect on the pollutant content of the gas stream.

4.3.2. *Particular requirements for compression-ignition engines*

A heated sample line for a continuous HC-analysis with the flame ionization detector (HFID), including recorder (R) must be used. The average concentration of the measured hydrocarbons must be determined by integration. Throughout the test, the temperature of the heated sample line must be controlled at  $463 \text{ K } (190 \text{ }^\circ\text{C}) \pm 10 \text{ K}$ . The heated sampling line must be fitted with a heated filter (Fh) 99 % efficient with particle  $\geq 0,3 \mu\text{m}$  to extract any solid particles from the continuous flow of gas required for analysis. The sampling system response time (from the probe to the analyser inlet) must be no more than four seconds.

The HFID must be used with a constant flow (heat exchanger) system to ensure a representative sample, unless compensation for varying CFV or CFO flows is made.

The particulate sampling unit consists of a dilution tunnel, a sampling probe, a filter unit, a partial-flow pump, and a flow rate regulator and measuring unit. The particulate-sampling part flow is drawn through two series-mounted filters. ► **M12** The sampling probe for the test gas flow for particulates must be so arranged within the dilution tract that a representative sample gas flow can be taken from the homogeneous air/exhaust mixture and an air/exhaust gas mixture temperature of  $325 \text{ K } (52 \text{ }^\circ\text{C})$  is not exceeded immediately before the particulate filter. ◀. The temperature of the gas flow in the flow meter may not fluctuate more than  $\pm 3 \text{ K}$ , nor may the mass flow-rate fluctuate by more than  $\pm 5 \%$ . Should the volume of flow change unacceptably as a result of excessive filter loading, the test must be stopped. When it is repeated, the rate of flow must be decreased and/or a larger filter used. The filters must be removed from the chamber no earlier than an hour before the test begins.

The necessary particle filters must be conditioned (as regards temperature and humidity) in an open dish which has been protected against dust ingress for at least eight and for not more than 56 hours before the test in an air-conditioned chamber. After this conditioning the uncontaminated filters are weighed and stored until they are used.

▼ **M9**

If the filters are not used within one hour of their removal from the weighing chamber they must be reweighed.

The one-hour limit may be replaced by an eight-hour limit if one or both of the following conditions are met:

- a stabilized filter is placed and kept in a sealed filter holder assembly with the ends plugged, or
- a stabilized filter is placed in a sealed filter holder assembly which is then immediately placed in a sample line through which there is no flow.

4.3.3. *Calibration*

Each analyser must be calibrated as often as necessary and in any case in the month before type-approval testing and at least once every six months for verifying conformity of production. The calibration method to be used is described in Appendix 6 for the analysers referred to in 4.3.1.

4.4. **Volume measurement**

4.4.1. The method of measuring total dilute exhaust volume incorporated in the constant volume sampler must be such that measurement is accurate to  $\pm 2\%$ .

4.4.2. *Constant volume sampler calibration*

The constant volume sampler system volume measurement device must be calibrated by a method sufficient to ensure the prescribed accuracy and at a frequency sufficient to maintain such accuracy.

An example of a calibration procedure which gives the required accuracy is given in Appendix 6. The method utilizes a flow metering device which is dynamic and suitable for the high flow-rate encountered in constant volume sampler testing. The device must be of certified accuracy in conformity with an approved national or international standard.

4.5. **Gases**4.5.1. *Pure gases*

The following pure gases must be available, if necessary, for calibration and operation:

- purified nitrogen  
(purity  $\leq 1$  ppm C,  $\leq 1$  ppm CO,  $\leq 400$  ppm CO<sub>2</sub>,  $\leq 0,1$  ppm NO),
- purified synthetic air  
(purity,  $\leq 1$  ppm C,  $\leq 1$  ppm CO,  $\leq 400$  ppm CO<sub>2</sub>,  $\leq 0,1$  ppm NO); oxygen content between 18 and 21 % vol,
- purified oxygen (purity  $\leq 99,5\%$  vol O<sub>2</sub>),
- purified hydrogen (and mixture containing hydrogen)  
(purity  $\leq 1$  ppm C,  $\leq 400$  ppm CO<sub>2</sub>).

4.5.2. *Calibration gases*

Gases having the following chemical compositions must be available: mixtures of:

- C<sub>3</sub>H<sub>8</sub> and purified synthetic air (4.5.1),
- CO and purified nitrogen,
- CO<sub>2</sub> and purified nitrogen,
- NO and purified nitrogen.

(The amount of NO<sub>2</sub> contained in this calibration gas must not exceed 5 % of the NO content).

The true concentration of a calibration gas must be within  $\pm 2\%$  of the stated figure.

The concentrations specified in Appendix 6 may also be obtained by means of a gas divider, diluting with purified N<sub>2</sub> or with purified synthetic air. The accuracy of the mixing device must be such that the concentrations of the diluted calibration gases may be determined to within  $\pm 2\%$ .

**▼ M9**

- 4.6. **Additional equipment**
- 4.6.1. *Temperatures*  
The temperatures indicated in Appendix 8 are measured with an accuracy of  $\pm 1,5$  K.
- 4.6.2. *Pressure*  
The atmospheric pressure must be measurable to within  $\pm 0,1$  kPa.
- 4.6.3. *Absolute humidity*  
The absolute humidity (H) must be measurable to within  $\pm 5$  %.
- 4.7. The exhaust gas-sampling system must be verified by the method described in section 3 of Appendix 7. The maximum permissible deviation between the quantity of gas introduced and the quantity of gas measured is 5 %.
5. PREPARING THE TEST
- 5.1. **Adjustment of inertia simulators to the vehicle's translatory inertia**  
An inertia simulator is used enabling a total inertia of the rotating masses to be obtained proportional to the reference mass within the following limits:

**▼ M12**

Reference mass of vehicle RW (kg)	Equivalent inertia I (kg)
RW $\leq$ 480	455
480 < RW $\leq$ 540	510
540 < RW $\leq$ 595	570
595 < RW $\leq$ 650	625
650 < RW $\leq$ 710	680
710 < RW $\leq$ 765	740
765 < RW $\leq$ 850	800
850 < RW $\leq$ 965	910
965 < RW $\leq$ 1 080	1 020
1 080 < RW $\leq$ 1 190	1 130
1 190 < RW $\leq$ 1 305	1 250
1 305 < RW $\leq$ 1 420	1 360
1 420 < RW $\leq$ 1 530	1 470
1 530 < RW $\leq$ 1 640	1 590
1 640 < RW $\leq$ 1 760	1 700
1 760 < RW $\leq$ 1 870	1 810
1 870 < RW $\leq$ 1 980	1 930
1 980 < RW $\leq$ 2 100	2 040
2 100 < RW $\leq$ 2 210	2 150
2 210 < RW $\leq$ 2 380	2 270
2 380 < RW $\leq$ 2 610	2 270
2 610 < RW	2 270

If the corresponding equivalent inertia is not available on the dynamometer, the larger value closest to the vehicle reference mass will be used.

**▼ M9**

- 5.2. **Setting of dynamometer**  
The load is adjusted according to methods described in 4.1.4.  
The method used and the values obtained (equivalent inertia — characteristic adjustment parameter) must be recorded in the test report.
- 5.3. **Preconditioning of the vehicle**
- 5.3.1. For compression-ignition engine vehicles for the purpose of measuring particulates at most 36 hours and at least six hours before testing, the Part Two cycle described in Appendix 1 must be used. Three consecutive cycles must be driven. The dynamometer setting is as indicated in 5.1 and 5.2.

**▼ M12**

At the request of the manufacturer vehicles with positive ignition engine may be preconditioned with one Part I and two Part II driving cycles.

**▼ M9**

After this preconditioning specific for compression ignition engines and before testing, compression-ignition and positive ignition engine vehicles must be kept in a room in which the temperature remains relatively constant between 293 and 303 K (20 and 30 °C). This conditioning must be carried out for at least six hours and continue until the engine oil temperature and coolant, if any, are within  $\pm 2$  K of the temperature of the room.

If the manufacturer so requests, the test must be carried out not later than 30 hours after the vehicle has been run at its normal temperature.

- 5.3.2. The tyre pressures must be the same as that specified by the manufacturer and used for the preliminary road test for brake adjustment. The tyre pressures may be increased by up to 50 % from the manufacturer's recommended setting in the case of a two-roller dynamometer. The actual pressure used must be recorded in the test report.

6. **PROCEDURE FOR BENCH TESTS**

6.1. **Special conditions for carrying out the cycle**

- 6.1.1. During the test, the test cell temperature must be between 293 and 303 K (20 and 30 °C). The absolute humidity (H) of either the air in the test cell or the intake air of the engine must be such that:

$$5,5 \leq H \leq 12,2 \text{ g H}_2\text{O/kg dry air}$$

- 6.1.2. The vehicle must be approximately horizontal during the test so as to avoid any abnormal distribution of the fuel.

**▼ M12**

- 6.1.3. At the end of the first 40-second idling period (see 6.2.2) a current of air of variable speed shall be blown over the vehicle. The blower speed shall be such that, within the operating range of 10 km/h to at least 50 km/h, the linear velocity of the air at the blower outlet is within  $\pm 5$  km/h of the corresponding roller speed. The final selection of the blower shall have the following characteristics:

- Area: at least 0,2 m<sup>2</sup>
- Height of the lower edge above ground: approximately 20 cm
- Distance from the front of the vehicle: approximately 30 cm

As an alternative the blower speed shall be at least 6m/s (21,6 km/h). At the request of the manufacturer for special vehicles (e.g. vans, off-road) the height of the cooling fan can be modified.

- 6.1.4. During the test the speed is recorded against time or collected by the data acquisition system so that the correctness of the cycles performed can be assessed.

**▼ M9**

6.2. **Starting-up the engine**

- 6.2.1. The engine must be started up by means of the devices provided for this purpose according to the manufacturer's instructions, as incorporated in the driver's handbook of production vehicles.
- 6.2.2. The engine must be kept idling for a period of 40 seconds. The first cycle must begin at the end of the aforesaid period of 40 seconds at idle.

6.3. **Idling**

- 6.3.1. *Manual-shift or semi-automatic gearbox*

**▼ M12**

See Appendix tables III.1.2 and III.1.3.

**▼ M9**

- 6.3.2. *Automatic-shift gearbox*
- After initial engagement the selector must not be operated at any time during the test except as in the case specified in 6.4.3 or if the selector can actuate the overdrive, if any.
- 6.4. **Accelerations**
- 6.4.1. Accelerations must be so performed that the rate of acceleration is as constant as possible throughout the phase.
- 6.4.2. If an acceleration cannot be carried out in the prescribed time, the extra time required is, if possible, deducted from the time allowed for changing gear, but otherwise from the subsequent steady-speed period.
- 6.4.3. *Automatic-shift gearboxes*
- If an acceleration cannot be carried out in the prescribed time, the gear selector is operated in accordance with requirements for manual-shift gearboxes.
- 6.5. **Deceleration**
- 6.5.1. All decelerations of the elementary urban cycle (Part One) are effected by removing the foot completely from the accelerator, the clutch remaining engaged. The clutch is disengaged, without use of the gear lever, at a speed of 10 km/h.
- All the decelerations of the extra-urban cycle (Part Two) are effected by removing the foot completely from the accelerator, the clutch remaining engaged. The clutch is disengaged, without use of the gear lever, at a speed of 50 km/h for the last deceleration.
- 6.5.2. If the period of deceleration is longer than that prescribed for the corresponding phase, the vehicle's brakes are used to enable the timing of the cycle to be complied with.
- 6.5.3. If the period of deceleration is shorter than that prescribed for the corresponding phase, the timing of the theoretical cycle is restored by constant speed or idling period merging into the following operation.
- 6.5.4. At the end of the deceleration period (halt of the vehicle on the rollers) of the elementary urban cycle (Part One) the gears are placed in neutral and the clutch engaged.
- 6.6. **Steady speeds**
- 6.6.1. Pumping or the closing of the throttle must be avoided when passing from acceleration to the following steady speed.
- 6.6.2. Periods of constant speed are achieved by keeping the accelerator position fixed.
7. GAS AND PARTICULATE SAMPLING AND ANALYSIS

**▼ M10**

- 7.1. **Sampling**
- Sampling begins at the start of the first elementary urban cycle as defined in 6.2.2 and ends on conclusion of the final idling period in the extra-urban cycle (Part Two).

**▼ M9**

- 7.2. **Analysis**
- 7.2.1. The exhaust gases contained in the bag must be analysed as soon as possible and in any event not later than 20 minutes after the end of the test cycle. The spent particulate filters must be taken to the chamber no later than one hour after conclusion of the test on the exhaust gases and must there be conditioned for between two and 36 hours and then be weighed.
- 7.2.2. Prior to each sample analysis the analyser range to be used for each pollutant must be set to zero with the appropriate zero gas.

**▼ M9**

- 7.2.3. The analysers are then set to the calibration curves by means of span gases of nominal concentrations of 70 to 100 % of the range.
- 7.2.4. The analysers' zeros are then rechecked. If the reading differs by more than 2 % of range from that set in 7.2.2, the procedure is repeated.
- 7.2.5. The samples are then analyzed.
- 7.2.6. After the analysis, zero and span points are rechecked using the same gases. If these rechecks are within 2 % of those in 7.2.3, the analysis is considered acceptable.
- 7.2.7. At all points in this section the flow-rates and pressures of the various gases must be the same as those used during calibration of the analysers.
- 7.2.8. The figure adopted for the concentration of each pollutant measured in the gases is that read off after stabilization on the measuring device. Hydrocarbon mass emissions of compression-ignition engines are calculated from the integrated HFID reading, corrected for varying flow if necessary as shown in Appendix 5.

8. DETERMINATION OF THE QUANTITY OF GASEOUS AND PARTICULATE POLLUTANTS EMITTED

8.1. **The volume considered**

The volume to be considered must be corrected to conform to the conditions of 101,33 kPa and 273,2 K.

8.2. **Total mass of gaseous and particulate pollutants emitted**

The mass  $m$  of each gaseous pollutant emitted by the vehicle during the test is determined by obtaining the product of the volumetric concentration and the volume of the gas in question, with due regard to the following densities under the abovementioned reference conditions:

- in the case of carbon monoxide (CO):  $d = 1,25 \text{ g/l}$ ,
- in the case of hydrocarbons ( $\text{CH}_{1,85}$ ):  $d = 0,619 \text{ g/l}$ ,
- in the case of nitrogen oxides ( $\text{NO}_2$ ):  $d = 2,05 \text{ g/l}$ .

The mass  $m$  of particulate pollutant emissions from the vehicle during the test is defined by weighing the mass of particulates collected by the two filters,  $m_1$  by the first filter,  $m_2$  by the second filter:

- if  $0,95 (m_1 + m_2) \leq m_1$ ,  $m = m_1$ ,
- if  $0,95 (m_1 + m_2) > m_1$ ,  $m = m_1 + m_2$ ,
- if  $m_2 > m_1$ , the test is cancelled.

Appendix 8 gives the calculations, followed by examples, used in determining the mass emissions of gaseous and particulate pollutants.

▼ **M9***Appendix 1***BREAKDOWN OF THE OPERATING CYCLE USED FOR THE TYPE I TEST**

1. OPERATING CYCLE
- 1.1. The operating cycle, made up of a Part One (urban cycle) and Part Two (extra-urban cycle), is illustrated at Figure III.1.1.
2. ELEMENTARY URBAN CYCLE (PART ONE)
- See Figure III.1.2 and Table III.1.2.

2.1. **Breakdown by phases**

	Time (s)	%	
Idling	60	30,8	} 35,4
Idling, vehicle moving, clutch engaged on one combination	9	4,6	
Gear-changing	8	4,1	
Accelerations	36	18,5	
Steady-speed periods	57	29,2	
Decelerations	25	12,8	
	195	100	

2.2. **Breakdown by use of gears**

	Time (s)	%	
Idling	60	30,8	} 35,4
Idling, vehicle moving, clutch engaged on one combination	9	4,6	
Gear-changing	8	4,1	
First gear	24	12,3	
Second gear	53	27,2	
Third gear	41	21	
	195	100	

2.3. **General information**

Average speed during test: 19 km/h.  
 Effective running time: 195 seconds.  
 Theoretical distance covered per cycle: 1,013 km.  
 Equivalent distance for the four cycles: 4,052 km.

▼M9

Figure III.1.1  
Operating cycle for the type I test

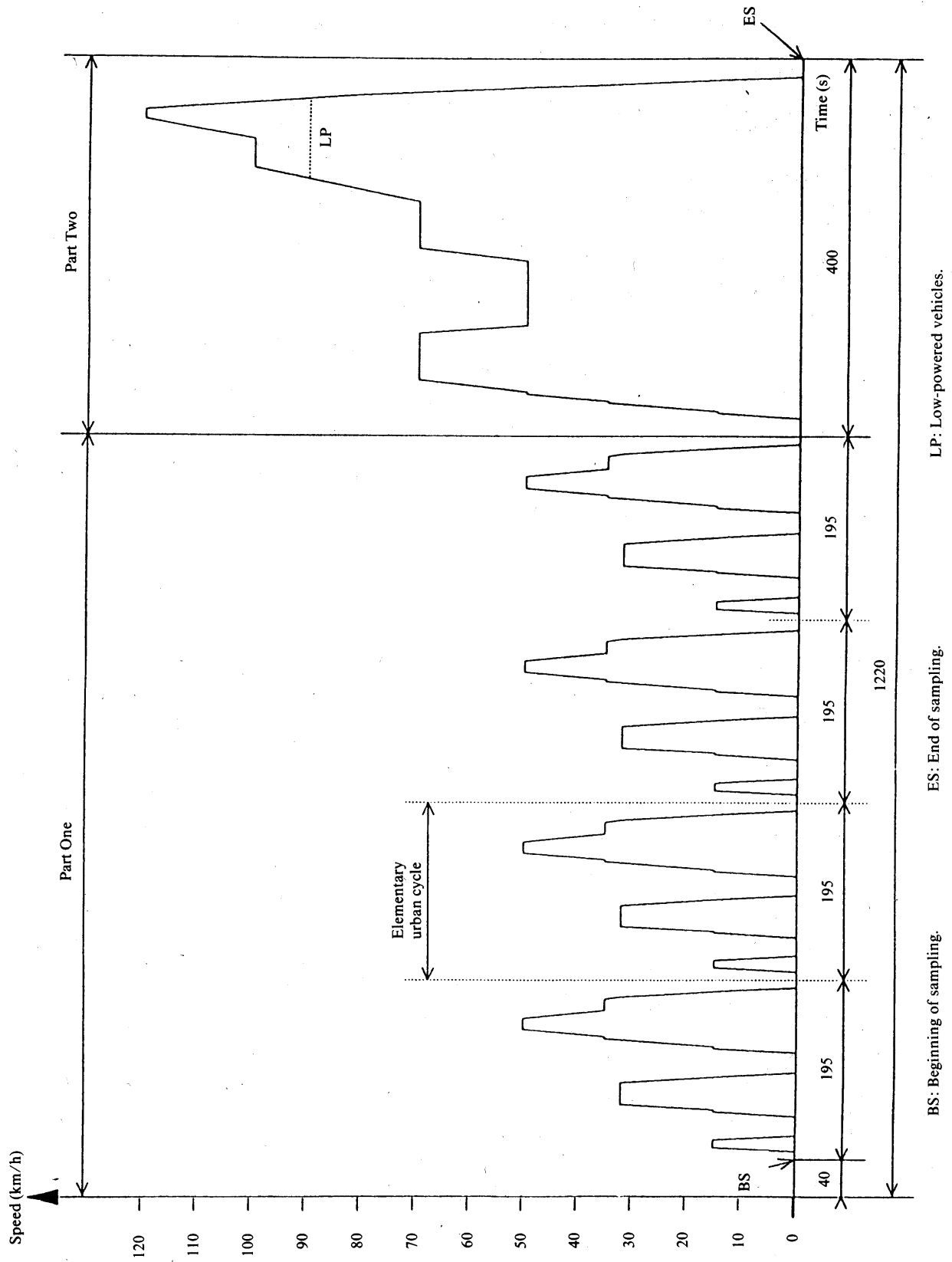



Table III.1.2

## Operating cycle on the chassis dynamometer (Part One)

No of operation	Operation	Phase	Acceleration (m/s <sup>2</sup> )	Speed (km/h)	Duration of each		Cumulative time (s)	Gear to be used in the case of a manual gearbox	
					Operation (s)	Phase (s)			
1	Idling	1			11	11	11	6 s PM + 5 s K <sub>1</sub> (*)	
2	Acceleration	2	1,04	0-15	4	4	15		
3	Steady speed	3		15	9	8	23		
4	Deceleration	4	-0,69	15-10	2	5	25		
5	Deceleration, clutch disengaged		3		-0,92		10-0		21
6	Idling	5			21	21	49		K <sub>1</sub> (*)
7	Acceleration	6	0,83	0-15	5	12	54		
8	Gear change	6		15-32	2	5	56		2
9	Acceleration		5		0,94		32		
10	Steady speed	7		32-10	24	8	85		2
11	Deceleration		8		-0,75		11		
12	Deceleration, clutch disengaged	8		10-0	3	21	96		K <sub>2</sub> (*)
13	Idling		21		-0,92		117		
14	Acceleration	9	0-15	0-15	5	26	122		16 s PM + 5 s K <sub>1</sub> (*)
15	Gear change		2		124				
16	Acceleration	10	0,62	15-35	9	8	133		
17	Gear change		2		135				
18	Acceleration	11	0,52	35-50	8	12	143		
19	Steady speed		12		155				
20	Deceleration	12	-0,52	50-35	8	13	163		
21	Steady speed		13		176				
22	Gear change	13		32-10	2	7	178		
23	Deceleration		7		-0,86		185		
24	Deceleration, clutch disengaged	14		10-0	3	7	188		K <sub>2</sub> (*)
25	Idling		7		-0,92		195		

(\*) PM = gearbox in neutral, clutch engaged.  
 K<sub>1</sub>, K<sub>2</sub> = first or second gear engaged, clutch disengaged.

▼M9

Figure III.1.2

Elementary urban cycle for the type I test

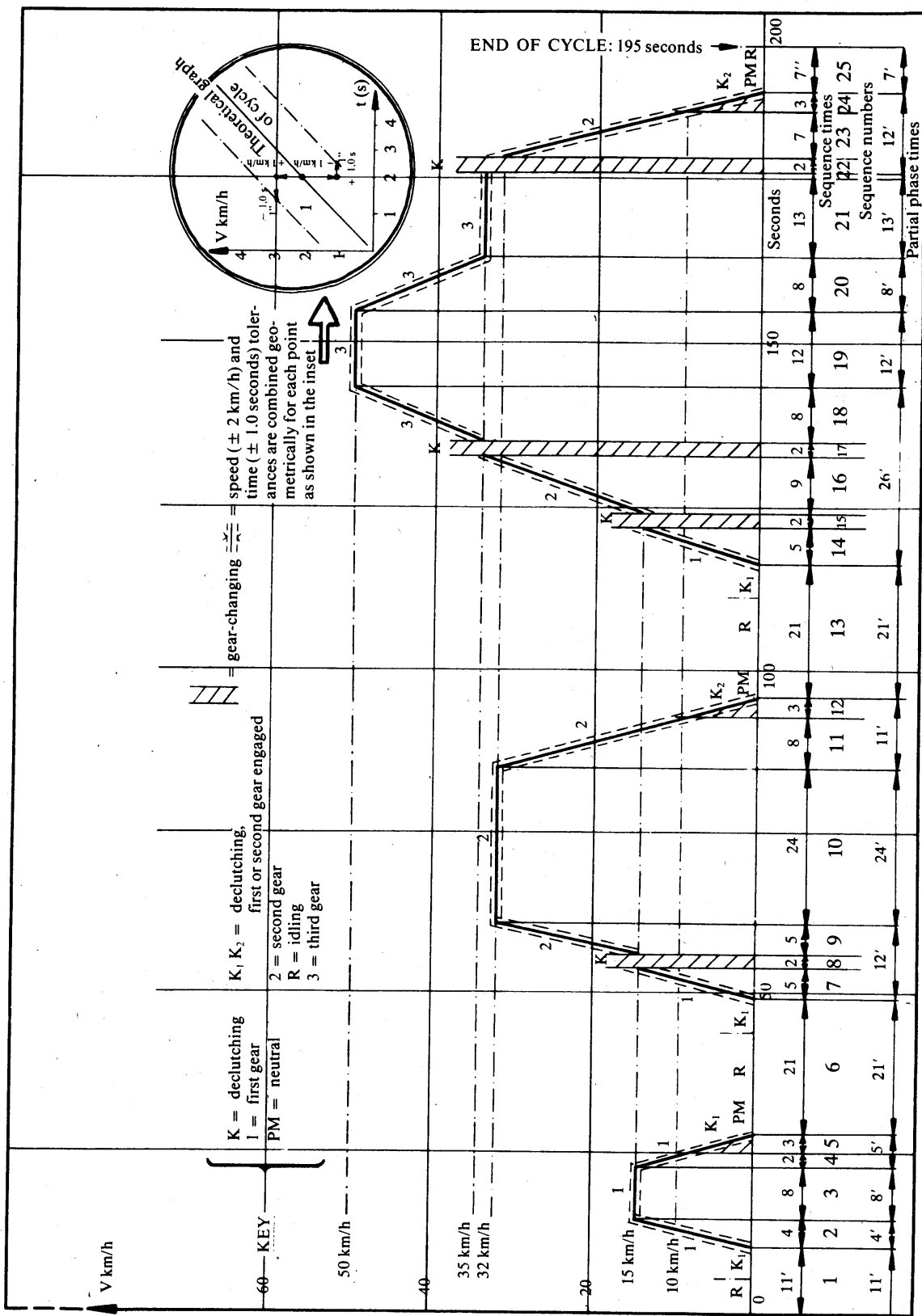

▼ **M9**

## 3. EXTRA - URBAN CYCLE (Part Two)

See Figure III.1.3 and Table III.1.3

3.1. **Breakdown by phases**

	Time (s)	%
Idling	20	5,0
Idling, vehicle moving, clutch engaged on one combination	20	5,0
Gear-changing	6	1,5
Accelerations	103	25,8
Steady-speed periods	209	52,2
Decelerations	42	10,5
	400	100

3.2. **Breakdown by use of gears**

	Time (s)	%
Idling	20	5,0
Idling, vehicle moving, clutch engaged on one combination	20	5,0
Gear-changing	6	1,5
First gear	5	1,3
Second gear	9	2,2
Third gear	8	2,0
Fourth gear	99	24,8
Fifth gear	233	58,2
	400	100

3.3. **General information**

Average speed during test: 62,6 km/h.  
 Effective running time: 400 seconds.  
 Theoretical distance covered per cycle: 6,955 km.  
 Maximal speed: 120 km/h.  
 Maximal acceleration: 0,833 m/s<sup>2</sup>.  
 Maximal deceleration: - 1,389 m/s<sup>2</sup>.

Table III.1.3  
Extra-urban cycle (Part Two) for the type I test

No of operation	Operation	Phase	Acceleration (m/s <sup>2</sup> )	Speed (km/h)	Duration of each		Cumulative time (s)	Gear to be used in the case of a manual gearbox
					Operation (s)	Phase (s)		
1	Idling	1			20	20	20	K1 (*)
2	Acceleration	2	0,83	0-15	5	41	25	1
3	Gear change				2		27	—
4	Acceleration	3	0,62	15-35	9	41	36	2
5	Gear change				2		38	—
6	Acceleration	4	0,52	35-30	8	41	46	3
7	Gear change				2		48	—
8	Acceleration	5	0,43	50-70	13	41	61	4
9	Steady speed				50		111	5
10	Deceleration	6	-0,69	70-50	8	41	119	4 s.5 + 4 s.4
11	Steady speed				69		188	4
12	Acceleration	7	0,43	50-70	13	41	201	4
13	Steady speed				50		251	5
14	Acceleration	8	0,24	70-100	35	41	286	5
15	Steady speed				30		316	5 (**)
16	Acceleration	9	0,28	100-120	20	41	336	5 (**)
17	Steady speed				10		346	5 (**)
18	Deceleration	10	-0,69	120-80	16	41	362	5 (**)
19	Deceleration				8		370	5 (**)
20	Deceleration, clutch disengaged	11	-1,04	80-50		41		
21	Idle				10		380	K <sub>s</sub> (*)
		13	-1,39	50-0	20		400	PM (*)

(\*) PM = gearbox in neutral, clutch engaged.

First or fifth gear engaged, clutch disengaged.

(\*\*) Additional gears can be used according to manufacturer recommendations if the vehicle is equipped with a transmission with more than five gears.

▼ M9

Figure III.1.3  
Extra-urban cycle (Part Two) for the type I test

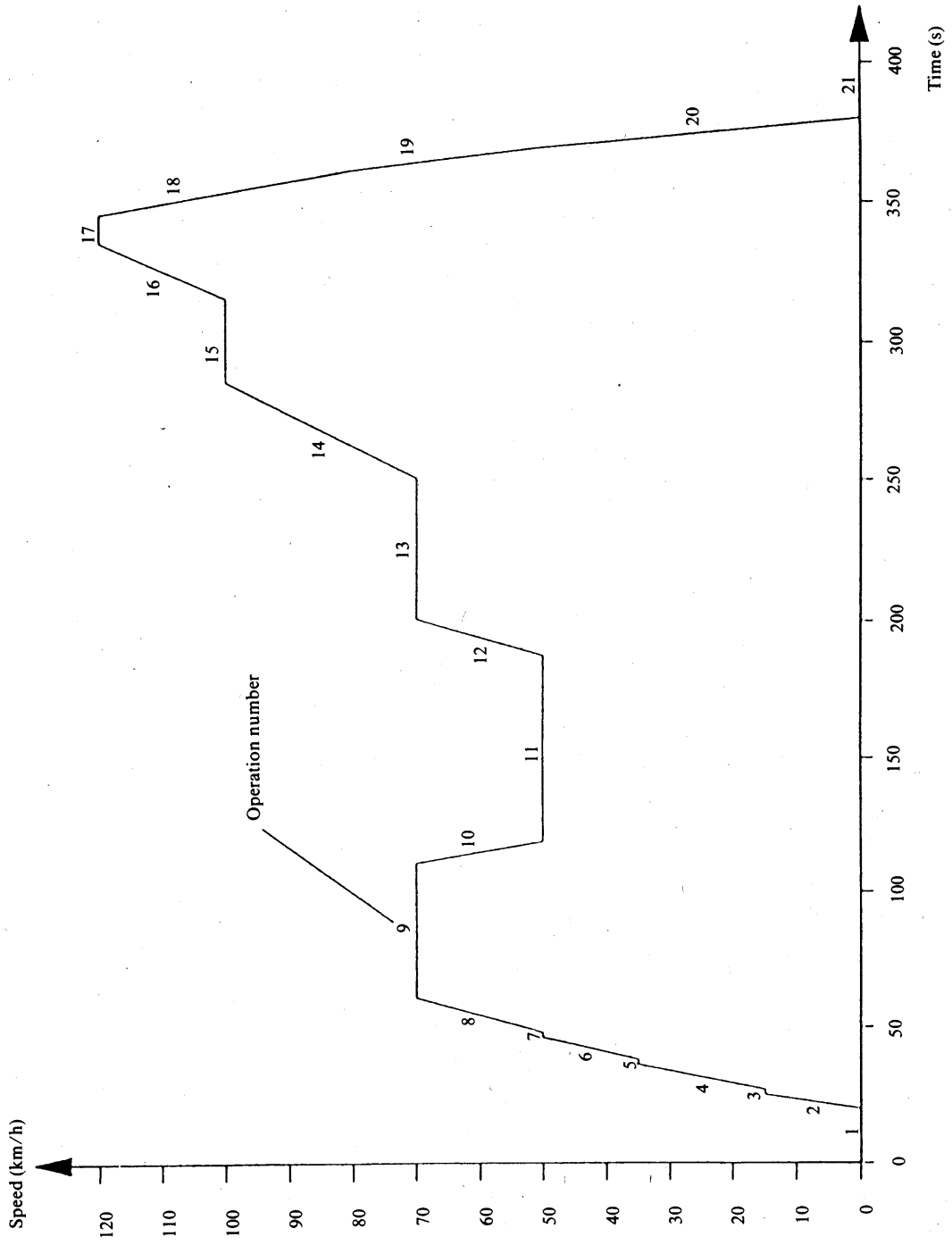

▼ **M9**

## 4. EXTRA - URBAN CYCLE (LOW-POWERED VEHICLES)

See Figure III.1.4 and Table III.1.4

4.1. **Breakdown by phases**

	Time (s)	%
Idling	20	5,0
Idling, vehicle moving, clutch engaged on one combination	20	5,0
Gear-changing	6	1,5
Accelerations	72	18,0
Steady-speed periods	252	63,0
Decelerations	30	7,5
	400	100

4.2. **Breakdown by use of gears**

	Time (s)	%
Idling	20	5,0
Idling, vehicle moving, clutch engaged on one combination	20	5,0
Gear-changing	6	1,5
First gear	5	1,3
Second gear	9	2,2
Third gear	8	2,0
Fourth gear	99	24,8
Fifth gear	233	58,2
	400	100

4.3. **General information**

Average speed during test: 59,3 km/h.  
 Effective running time: 400 seconds.  
 Theoretical distance covered per cycle: 6,594 km.  
 Maximal speed: 90 km/h.  
 Maximal acceleration: 0,833 m/s<sup>2</sup>.  
 Maximal deceleration: - 1,389 m/s<sup>2</sup>.

Table III.1.4  
Extra-urban cycle (low-powered vehicles) for the type I test

No of operation	Operation	Phase	Acceleration (m/s <sup>2</sup> )	Speed (km/h)	Duration of each		Cumulative time (s)	Gear to be used in the case of a manual gearbox
					Operation (s)	Phase (s)		
1	Idling	1			20	20	20	K <sub>1</sub> (*)
2	Acceleration	2	0,83	0-15	5	41	25	1
3	Gear change				2		27	—
4	Acceleration	2	0,62	15-35	9	41	36	2
5	Gear change				2		38	—
6	Acceleration	2	0,52	35-50	8	41	46	3
7	Gear change				2		48	—
8	Acceleration	3	0,43	50-70	13	50	61	4
9	Steady speed				50		111	5
10	Deceleration	4	-0,69	70-50	8	8	119	4 s.5 + 4 s.4
11	Steady speed				69		188	4
12	Acceleration	6	0,43	50-70	13	13	201	4
13	Steady speed				50		251	5
14	Acceleration	8	0,24	70-90	24	24	275	5
15	Steady speed				83		358	5
16	Deceleration	10	-0,69	90-80	4	22	362	5
17	Deceleration				8		370	5
18	Deceleration	11	-1,39	50-00	10	20	380	K <sub>5</sub> (*)
19	Idle				20		400	PM (*)

(\*) PM = gearbox in neutral, clutch engaged.  
K<sub>1</sub>, K<sub>5</sub>: first or fifth gear engaged, clutch disengaged.

▼ M9

Figure III.1.4

Extra-urban cycle (Part Two) for the type I test  
(underpowered vehicles)

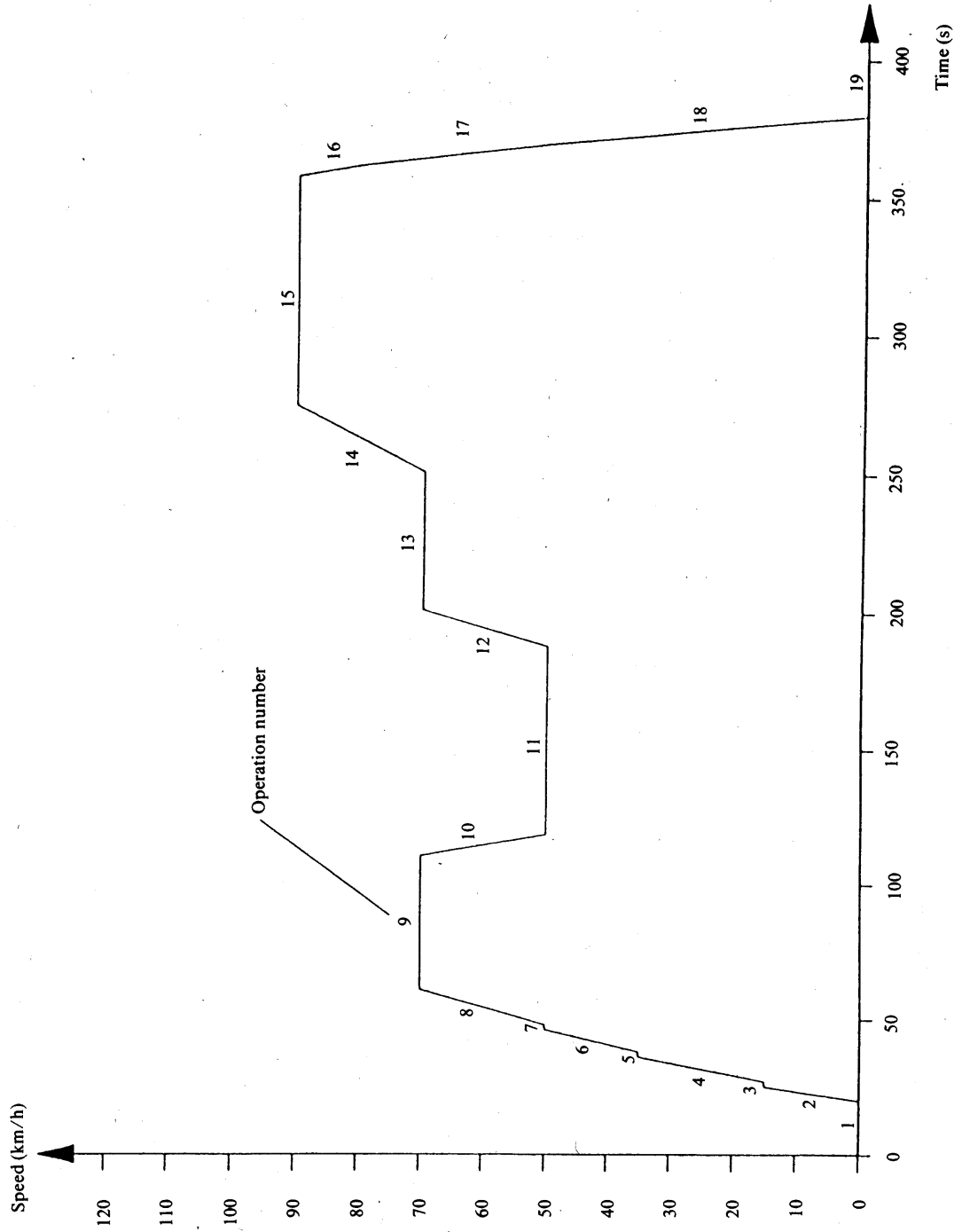



▼ M9

## Appendix 2

## CHASSIS DYNAMOMETER

## 1. DEFINITION OF A CHASSIS DYNAMOMETER WITH FIXED LOAD CURVE

## 1.1. Introduction

In the event that the total resistance to progress on the road is not reproduced on the chassis dynamometer between speeds of 10 and ► M12 120 km/h ◀, it is recommended to use a chassis dynamometer having the characteristics defined below.

## 1.2. Definition

## 1.2.1. The chassis dynamometer may have one or two rollers.

The front roller drives, directly or indirectly, the inertia masses and the power absorption device.

▼ M12

## 1.2.2. The load absorbed by the brake and the chassis dynamometer internal frictional effects from the speed of 0 to 120 km/h is as follows:

$$F = (a + b \cdot V^2) \pm 0,1 \cdot F_{80} \text{ (without being negative)}$$

where:

F = total load absorbed by the chassis dynamometer (N)

a = value equivalent to rolling resistance (N)

b = value equivalent to coefficient of air resistance (N/(km/h)<sup>2</sup>)

V = speed (km/h)

F<sub>80</sub> = load at the speed of 80 km/h (N).

▼ M9

## 2. METHOD OF CALIBRATING THE DYNAMOMETER

## 2.1. Introduction

▼ M12

This Appendix describes the method to be used to determine the load absorbed by a dynamometer brake.

The load absorbed comprises the load absorbed by frictional effects and the load absorbed by the power-absorption device.

▼ M9

The dynamometer is brought into operation beyond the range of test speeds. The device used for starting up the dynamometer is then disconnected: the rotational speed of the driven roller decreases.

The kinetic energy of rollers is dissipated by the power-absorption unit and by the frictional effects. This method disregards variations in the roller's internal frictional effects caused by rollers with or without the vehicle. The frictional effects of the rear roller shall be disregarded when this is free.

2.2. ► M12 Calibrating the load indicator to 80 km/h as a function of the load absorbed ◀

The following procedure is used (see also Figure III.2.2.2).

## 2.2.1. Measure the rotational speed of the roller if this has not already been done. A fifth wheel, a revolution counter or some other method may be used.

## 2.2.2. Place the vehicle on the dynamometer or devise some other method of starting up the dynamometer.

## 2.2.3. Use the fly-wheel or any other system of inertia simulation for the particular inertia class to be used.

▼ **M12**

Figure III.2.2.2.

Diagram illustrating the load of the chassis dynamometer

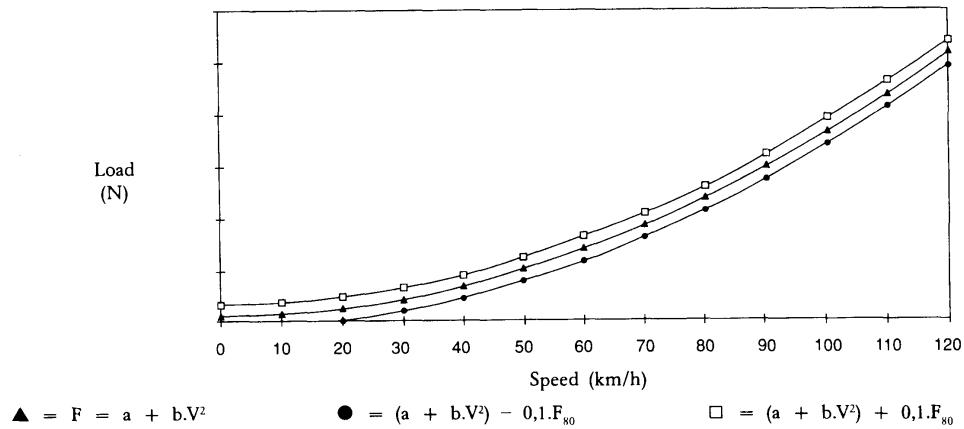
▼ **M9**

2.2.4. Bring the dynamometer to a speed of 80 km/h.

▼ **M12**2.2.5. Note the load indicated  $F_i$  (N).▼ **M9**

2.2.6. Bring the dynamometer to a speed of 90 km/h.

2.2.7. Disconnect the device used to start up the dynamometer.

2.2.8. Note the time taken by the dynamometer to pass from a speed of 85 km/h to a speed of 75 km/h.

2.2.9. Set the power-absorption device at a different level.

2.2.10. The requirements of 2.2.4 to 2.2.9 must be repeated sufficiently often to cover the range of ► **M12** load ◀ used.▼ **M12**

2.2.11. Calculate the load absorbed, using the formula

$$F = \frac{M_i \cdot \Delta V}{t}$$

where

F = load absorbed in N

 $M_i$  = equivalent inertia in kilograms (excluding the inertial effects of free rear roller) $\Delta V$  = speed deviation in m/s (10 km/h = 2,775 m/s)

t = time taken by the roller to pass from 85 to 75 km/h.

2.2.12. Figure III.2.2.12 shows the load indicated at 80 km/h in terms of the load absorbed at 80 km/h.

▼ **M12**

Figure III.2.2.12

Load indicated at 80 km/h in terms of load absorbed at 80 km/h

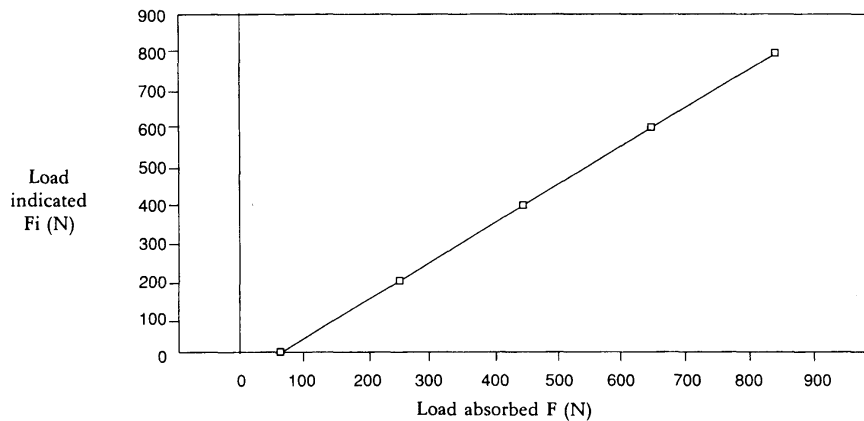
▼ **M9**

2.2.13. The operation described in 2.2.3 to 2.2.12 must be repeated for all inertia classes to be used.

2.3. ► **M12** Calibration of the load indicator as a function of the absorbed load for other speeds ◀

The procedures described in 2.2 must be repeated as often as necessary for the chosen speeds.

2.4. Verification of the ► **M12** load ◀ -absorption curve of the dynamometer from a reference setting at a speed of 80 km/h

2.4.1. Place the vehicle on the dynamometer or devise some other method of starting up the dynamometer.

2.4.2. Adjust the dynamometer to the absorbed ► **M12** load ◀ at 80 km/h.

▼ **M12**

2.4.3. Note the load absorbed at 120, 100, 80, 60, 40 and 20 km/h.

▼ **M9**

► **M12** 2.4.4. Draw the curve  $F(V)$  ◀ and verify that it corresponds to the requirements of 1.2.2.

2.4.5. Repeat the procedure set out in 2.4.1 to 2.4.4 for other values of ► **M12** load  $F$  ◀ at 80 km/h and for other values of inertia.

2.5. The same procedure must be used for force or torque calibration.

3. SETTING OF THE DYNAMOMETER

▼ **M12**

3.1. Setting methods

The dynamometer setting may be carried out at a constant speed of 80 km/h in accordance with the requirements of Appendix 3.

▼ **M9**

3.1.1. Introduction

This method is not a preferred method and must be used only with fixed load curve shape dynamometers for determination of load setting at 80 km/h and cannot be used for vehicles with compression-ignition engines.

3.1.2. Test instrumentation

The vacuum (or absolute pressure) in the intake manifold vehicle is measured to an accuracy of  $\pm 0,25$  kPa. It must be possible to record this reading continuously or at intervals of no more than one second. The speed must be recorded continuously with a precision of  $\pm 0,4$  km/h.

**▼M9**

- 3.1.3. *Road test*
- 3.1.3.1. Ensure that the requirements of section 4 of Appendix 3 are met.
- 3.1.3.2. Drive the vehicle at a steady speed of 80 km/h recording speed and vacuum (or absolute pressure) in accordance with the requirements of 3.1.2.
- 3.1.3.3. Repeat procedure set out in 3.1.3.2 three times in each direction. All six runs must be completed within four hours.
- 3.1.4. *Data reduction and acceptance criteria*
- 3.1.4.1. Review results obtained in accordance with 3.1.3.2 and 3.1.3.3 (speed must not be lower than 79,5 km/h or greater than 80,5 km/h for more than one second). For each run, read vacuum level at one-second intervals, calculate mean vacuum ( $\bar{v}$ ) and standard deviation(s). This calculation must consist of no less than 10 readings of vacuum.
- 3.1.4.2. The standard deviation must not exceed 10 % of mean ( $\bar{v}$ ) for each run.
- 3.1.4.3. Calculate the mean value ( $\bar{v}$ ) for the six runs (three runs in each direction).
- 3.1.5. *Dynamometer setting*
- 3.1.5.1. *Preparation*
- Perform the operations specified in 5.1.2.2.1 to 5.1.2.2.4 of Appendix 3.
- 3.1.5.2. *Setting*
- After warm-up, drive the vehicle at a steady speed of 80 km/h and adjust dynamometer load to reproduce the vacuum reading ( $v$ ) obtained in accordance with 3.1.4.3. Deviation from this reading must be no greater than 0,25 kPa. The same instruments are used for this exercise as were used during the road test.

**▼M12**

- 3.2. **Alternative method**
- With the manufacturer's agreement the following method may be used:
- 3.2.1. The brake is adjusted so as to absorb the load exerted at the driving wheels at a constant speed of 80 km/h in accordance with the following table:

Reference mass of vehicles	Equivalent inertia	Power and load absorbed by the dynamometer at 80 km/h		Coefficients	
				a	b
RW (kg)	kg	kW	N	N	N/(km/h) <sup>2</sup>
RW ≤ 480	455	3,8	171	3,8	0,0261
480 < RW ≤ 540	510	4,1	185	4,2	0,0282
540 < RW ≤ 595	570	4,3	194	4,4	0,0296
595 < RW ≤ 650	625	4,5	203	4,6	0,0309
650 < RW ≤ 710	680	4,7	212	4,8	0,0323
710 < RW ≤ 765	740	4,9	221	5,0	0,0337
765 < RW ≤ 850	800	5,1	230	5,2	0,0351
850 < RW ≤ 965	910	5,6	252	5,7	0,0385
965 < RW ≤ 1 080	1 020	6,0	270	6,1	0,0412
1 080 < RW ≤ 1 190	1 130	6,3	284	6,4	0,0433
1 190 < RW ≤ 1 305	1 250	6,7	302	6,8	0,0460
1 305 < RW ≤ 1 420	1 360	7,0	315	7,1	0,0481
1 420 < RW ≤ 1 530	1 470	7,3	329	7,4	0,0502
1 530 < RW ≤ 1 640	1 590	7,5	338	7,6	0,0515
1 640 < RW ≤ 1 760	1 700	7,8	351	7,9	0,0536
1 760 < RW ≤ 1 870	1 810	8,1	365	8,2	0,0557

▼ **M12**

Reference mass of vehicles	Equivalent inertia	Power and load absorbed by the dynamometer at 80 km/h		Coefficients	
				a	b
RW (kg)	kg	kW	N	N	N/(km/h) <sup>2</sup>
1 870 < RW ≤ 1 980	1 930	8,4	378	8,5	0,0577
1 980 < RW ≤ 2 100	2 040	8,6	387	8,7	0,0591
2 100 < RW ≤ 2 210	2 150	8,8	396	8,9	0,0605
2 210 < RW ≤ 2 380	2 270	9,0	405	9,1	0,0619
2 380 < RW ≤ 2 610	2 270	9,4	423	9,5	0,0646
2 610 < RW	2 270	9,8	441	9,9	0,0674

- 3.2.2. In the case of vehicles, other than passenger cars, with a reference mass of more than 1 700 kg, or vehicles with permanent all-wheel drive, the power values given in the table set out in 3.2.1 are multiplied by the factor 1,3.
-

**▼M9***Appendix 3***RESISTANCE TO PROGRESS OF A VEHICLE — MEASUREMENT METHOD ON THE ROAD — SIMULATION ON A CHASSIS DYNAMOMETER**

## 1. OBJECT OF THE METHODS

The object of the methods defined below is to measure the resistance to progress of a vehicle at stabilized speeds on the road and to simulate this resistance on a dynamometer, in accordance with section 4.1.5 of Annex III.

## 2. DEFINITION OF THE ROAD

The road must be level and sufficiently long to enable the measurements specified below to be made. The slope must be constant to within  $\pm 0,1$  % and must not exceed 1,5 %.

## 3. ATMOSPHERIC CONDITIONS

3.1. **Wind**

Testing must be limited to wind speeds averaging less than 3 m/s with peak speeds less than 5 m/s. In addition, the vector component of the wind speed across the test road must be less than 2 m/s. Wind velocity must be measured 0,7 m above the road surface.

3.2. **Humidity**

The road must be dry.

3.3. **Pressure — Temperature**

Air density at the time of the test must not deviate by more than  $\pm 7,5$  % from the reference conditions,  $p = 100$  kPa and  $T = 293,2$  K.

## 4. VEHICLE PREPARATION

**▼M12**4.1. **Selection of the test vehicle**

If not all variants of a vehicle type<sup>(1)</sup> are measured the following criteria for the selection of the test vehicle shall be used.

## 4.1.1. Body

If there are different types of body, the worst one in terms of aerodynamics shall be chosen. The manufacturer shall provide appropriate data for the selection.

## 4.1.2. Tyres

The widest tyre shall be chosen. If there are more than three tyre sizes, the widest minus one shall be chosen.

## 4.1.3. Testing mass

The testing mass shall be the reference mass of the vehicle with the highest inertia range.

## 4.1.4. Engine

The test vehicle shall have the largest heat exchanger(s).

## 4.1.5. Transmission

A test shall be carried out with each type of the following transmissions:

- front wheel drive
- rear wheel drive
- full time 4 × 4

<sup>(1)</sup> According to Directive 70/156/EEC.

▼ **M12**

- part time 4 × 4
- automatic gear box
- manual gear box

▼ **M9**▶ **M12** 4.2. ◀ **Running in**

The vehicle must be in normal running order and adjustment after having been run-in for at least 3 000 km. The tyres must be run in at the same time as the vehicle or have a tread depth within 90 and 50 % of the initial tread depth.

▶ **M12** 4.3. ◀ **Verifications**

The following checks must be made in accordance with the manufacturer's specifications for the use considered:

- wheels, wheel trims, tyres (make, type, pressure),
- front axle geometry,
- brake adjustment (elimination of parasitic drag),
- lubrication of front and rear axles,
- adjustment of the suspension and vehicle level, etc.

▶ **M12** 4.4. ◀ **Preparation for the test**

▶ **M12** 4.4.1. ◀ The vehicle is loaded to its reference mass. The level of the vehicle must be that obtained when the centre of gravity of the load is situated midway between the 'R' points of the front outer seats and on a straight line passing through those points.

▶ **M12** 4.4.2. ◀ In the case of road tests, the windows of the vehicle must be closed. Any covers of air climatization systems, headlamps, etc, must be in the non-operating position.

▶ **M12** 4.4.3. ◀ The vehicle must be clean.

▶ **M12** 4.4.4. ◀ Immediately prior to the test the vehicle is brought to normal running temperature in an appropriate manner.

## 5. METHODS

## 5.1. Method of energy variation during coast-down

5.1.1. *On the road*

## 5.1.1.1. Test equipment and error:

- time must be measured to an error lower than 0,1 second,
- speed must be measured to an error lower than 2 %.

## 5.1.1.2. Test procedure

5.1.1.2.1. Accelerate the vehicle to a speed 10 km/h greater than the chosen test speed  $V$ .

5.1.1.2.2. Place the gearbox in 'neutral' position.

5.1.1.2.3. Measure the time ( $t_1$ ) taken for the vehicle to decelerate from

$$V_2 = V + V \text{ km/h to } V_1 = V - V \text{ km/h with } V \leq 5 \text{ km/h}$$

5.1.1.2.4. Perform the same test in the opposite direction:  $t_2$

5.1.1.2.5. Take the average  $\bar{T}$  of the two times  $t_1$  and  $t_2$ .

5.1.1.2.6. Repeat these tests several times such that the statistical accuracy ( $p$ ) of the average

$$T = \frac{1}{n} \sum_{i=1}^n T_i \text{ is not more than } 2 \% (p \leq 2 \%)$$

The statistical accuracy ( $p$ ) is defined by:

$$p = \frac{t \cdot s}{\sqrt{n}} \cdot \frac{100}{\bar{T}}$$

where:

$t$  = coefficient given by the table below,

▼ **M9**

$$s = \text{standard deviation, } s = \sqrt{\frac{\sum_{i=1}^n (T_i - \bar{T})^2}{n-1}}$$

n = number of tests,

n	4	5	6	7	8	9	10	11	12	13	14	15
t	3,2	2,8	2,6	2,5	2,4	2,3	2,3	2,2	2,2	2,2	2,2	2,2
$\frac{t}{\sqrt{n}}$	1,6	1,25	1,06	0,94	0,85	0,77	0,73	0,66	0,64	0,61	0,59	0,57

5.1.1.2.7. Calculate the power by the formula:

$$P = \frac{M V \Delta V}{T}$$

where:

P = is expressed in kw,

V = speed of the test in m/s,

$\Delta V$  = speed deviation from speed V, in m/s,

M = reference mass in kg,

T = time in seconds.

▼ **M12**

5.1.1.2.8. The power (P) determined on the track shall be corrected to the reference ambient conditions as follows:

$$P_{\text{corrected}} = K \cdot P_{\text{measured}}$$

$$K = \frac{R_R}{R_T} \cdot [1 + K_R(t - t_0)] + \frac{R_{\text{AERO}}}{R_T} \cdot \frac{(\rho_0)}{\rho}$$

where

$R_R$  = rolling resistance at speed V

$R_{\text{AERO}}$  = aerodynamic drag at speed V

$R_T$  = total driving resistance =  $R_R + R_{\text{AERO}}$

$K_R$  = temperature correction factor of rolling resistance, taken to be equal to:  $3,6 \cdot 10^{-3}/^{\circ}\text{C}$

t = road test ambient temperature in  $^{\circ}\text{C}$

$t_0$  = reference ambient temperature =  $20^{\circ}\text{C}$

$\rho$  = air density at the test conditions

$\rho_0$  = air density at the reference conditions ( $20^{\circ}\text{C}$ , 100 kPa)

The ratios  $R_R/R_T$  and  $R_{\text{AERO}}/R_T$  shall be specified by the vehicle manufacturer on the basis of the data normally available to the company.

If these values are not available, subject to the agreement of the manufacturer and the technical service concerned, the figures for the rolling/total resistance ratio given by the following formula may be used:

$$\frac{R_R}{R_T} = a \cdot M + b$$

where:

M = vehicle mass in kg

and for each speed the coefficients a and b are shown in the following table:

V (km/h)	a	b
20	$7,24 \cdot 10^{-5}$	0,82
30	$1,25 \cdot 10^{-4}$	0,67



**▼ M12**

V (km/h)	a	b
40	$1,59 \cdot 10^{-4}$	0,54
50	$1,86 \cdot 10^{-4}$	0,42
90	$1,71 \cdot 10^{-4}$	0,21
120	$1,57 \cdot 10^{-4}$	0,14

**▼ M9**

5.1.2. *On the dynamometer*

5.1.2.1. Measurement equipment and accuracy

The equipment must be identical to that used on the road.

5.1.2.2. Test procedure

5.1.2.2.1. Install the vehicle on the test dynamometer.

5.1.2.2.2. Adjust the tyre pressure (cold) of the driving wheels as required by the dynamometer.

5.1.2.2.3. Adjust the equivalent inertia of the dynamometer.

5.1.2.2.4. Bring the vehicle and dynamometer to operating temperature in a suitable manner.

5.1.2.2.5. Carry out the operations specified in 5.1.1.2 with the exception of 5.1.1.2.4 and 5.1.1.2.5 and with replacing M by I in the formula set out in 5.1.1.2.7.

**▼ M12**

5.1.2.2.6. Adjust the brake to reproduce the corrected power (Section 5.1.1.2.8) and to take into account the difference between the vehicle mass (M) on the track and the equivalent inertia test mass (I) to be used. This may be done by calculating the mean corrected road coast down time from  $V_2$  to  $V_1$  and reproducing the same time on the dynamometer by the following relationship:

$$T_{\text{corrected}} = \frac{T_{\text{measured}}}{K} \cdot \frac{I}{M}$$

K = specified in 5.1.1.2.8.

5.1.2.2.7. The power  $P_a$  to be absorbed by the bench should be determined in order to enable the same power (Section 5.1.1.2.8) to be reproduced for the same vehicle on different days.

**▼ M9**

5.2. **Torque measurement method at constant speed**

5.2.1. *On the road*

5.2.1.1. Measurement equipment and error

Torque measurement must be carried out with an appropriate measuring device accurate to within 2 %.

Speed measurement must be accurate to within 2 %.

5.2.1.2. Test procedure

5.2.1.2.1. Bring the vehicle to the chosen stabilized speed V.

**▼ M12**

5.2.1.2.2. Record the torque  $C_{(t)}$  and speed over a period of least 20 s. The accuracy of the data recording system shall be at least  $\pm 1$  Nm for the torque and  $\pm 0,2$  km/h for the speed.

**▼ M9**

5.2.1.2.3. Differences in torque  $C_{(t)}$  and speed relative to time must not exceed 5 % for each second of the measurement period.

5.2.1.2.4. The torque C is the average torque derived from the following formula:

$$C_{t_i} = \frac{1}{\Delta t} \int_t^{t+\Delta t} C(t) dt$$

**▼ M12**

- 5.2.1.2.5. The test shall be carried out three times in each direction. Determine the average torque from these six measurements for the reference speed. If the average speed deviates by more than 1 km/h from the reference speed, a linear regression shall be used for calculating the average torque.

**▼ M9**

- 5.2.1.2.6. Determine the average of these two torques  $C_{\text{r}}$  and  $C_{\text{e}}$  i.e.  $C_{\text{r}}$ .

**▼ M12**

- 5.2.1.2.7. The average torque  $C_{\text{T}}$  determined on the track shall be corrected to the reference ambient conditions as follows:

$$C_{\text{Tcorrected}} = K \cdot C_{\text{Tmeasured}}$$

where K is defined in 5.1.1.2.8 of this Appendix.

**▼ M9**

- 5.2.2. *On the dynamometer*

- 5.2.2.1. Measurement equipment and error

The equipment must be identical to that used on the road.

- 5.2.2.2. Test procedure

- 5.2.2.2.1. Perform the operations specified in 5.1.2.2.1 to 5.1.2.2.4.

- 5.2.2.2.2. Perform the operations specified in 5.2.1.2.1 to 5.2.1.2.4.

**▼ M12**

- 5.2.2.2.3. Adjust the power absorption unit to reproduce the corrected total track torque of 5.2.1.2.7.

- 5.2.2.2.4. Proceed with the same operations as in 5.1.2.2.7, for the same purpose.

▼ **M9***Appendix 4***VERIFICATION OF INERTIAS OTHER THAN MECHANICAL**

## 1. OBJECT

The method described in this Appendix makes it possible to check that the simulated total inertia of the dynamometer is carried out satisfactorily in the running phases of the operating cycle. ► **M12** The manufacturer of the dynamometer shall provide a method to verify the specifications according to Section 3. ◀

## 2. PRINCIPLE

2.1. **Drawing up working equations**

Since the dynamometer is subjected to variations in the rotating speed of the roller(s), the force at the surface of the roller(s) can be expressed by the formula:

$$F = I \cdot \gamma = I_M \cdot \gamma + F_i$$

where:

F = force at the surface of the roller(s),

I = total inertia of the dynamometer (equivalent inertia of the vehicle: see table in Annex III section 5.1),

$I_M$  = inertia of the mechanical masses of the dynamometer,

$\gamma$  = tangential acceleration at roller surface,

$F_i$  = inertia force.

*Note:*

An explanation of this formula with reference to dynamometers with mechanically simulated inertias is appended.

Thus, the total inertia is expressed as follows:

$$I = I_M + \frac{F_i}{\gamma}$$

where:

$I_M$  can be calculated or measured by traditional methods.

$F_i$  can be measured on the dynamometer, but can also be calculated from the peripheral speed of the rollers.  $\gamma$  may be calculated from the peripheral speed of the rollers.

The total inertia (I) is determined during an acceleration or deceleration test with values higher than or equal to those obtained on an operating cycle.

2.2. **Specification for the calculation of total inertia**

The test and calculation methods must make it possible to determine the total inertia I with a relative error ( $\Delta I/I$ ) of less than 2 %.

## 3. SPECIFICATION

3.1. The mass of the simulated total inertia I must remain the same as the theoretical value of the equivalent inertia (see 5.1 of Annex III) within the following limits:

3.1.1.  $\pm 5$  % of the theoretical value for each instantaneous value;

3.1.2.  $\pm 2$  % of the theoretical value for the average value calculated for each sequence of the cycle.

3.2. The limit given in 3.1.1 is brought to  $\pm 50$  % for one second when starting and, for vehicles with manual transmission, for two seconds during gear changes.

**▼ M9**

4. VERIFICATION PROCEDURE
- 4.1. Verification is carried out during each test throughout the cycle defined in 2.1 of Annex III.
- 4.2. However, if the requirements of section 3 are met, with instantaneous accelerations which are at least three times greater or smaller than the values obtained in the sequences of the theoretical cycle, the verification described above is not necessary.

**▼ M12**

---

**DESCRIPTION OF TAILPIPE EMISSION-SAMPLING SYSTEMS**

1. INTRODUCTION
  - 1.1. There are several types of sampling devices capable of meeting the requirements set out in section 4.2 of Annex III.  
The devices described in 3.1, 3.2 and 3.3 will be deemed acceptable if they satisfy the main criteria relating to the variable dilution principle.
  - 1.2. In its communications, the laboratory must mention the system of sampling used when performing the test.
2. CRITERIA RELATING TO THE VARIABLE-DILUTION SYSTEM FOR MEASURING EXHAUST-GAS EMISSIONS
  - 2.1. **Scope**  
This section specifies the operating characteristics of an exhaust-gas sampling system intended to be used for measuring the true mass emissions of a vehicle exhaust in accordance with the provisions of this Directive. The principle of variable-dilution sampling for measuring mass emissions requires three conditions to be satisfied:
    - 2.1.1. the vehicle exhaust gases must be continuously diluted with ambient air under specified conditions;
    - 2.1.2. the total volume of the mixture of exhaust gases and dilution air must be measured accurately;
    - 2.1.3. a continuously proportional sample of the diluted exhaust gases and the dilution air must be collected for analysis.  
The quantity of gaseous pollutants emitted is determined from the proportional sample concentrations and the total volume measured during the test. The sample concentrations are corrected to take account of the pollutant content of the ambient air. In addition, where vehicles are equipped with compression-ignition engines, their particulate emissions are plotted.
  - 2.2. **Technical summary**  
Figure III.5.2.2 gives a schematic diagram of the sampling system.
    - 2.2.1. The vehicle exhaust gases must be diluted with a sufficient amount of ambient air to prevent any water condensation in the sampling and measuring system.
    - 2.2.2. The exhaust-gas sampling system must be so designed as to make it possible to measure the average volume concentrations of the CO<sub>2</sub>, CO, HC and NO<sub>x</sub>, and, in addition, in the case of vehicles equipped with compression-ignition engines, of the particulate emissions, contained in the exhaust gases emitted during the vehicle testing cycle.
    - 2.2.3. The mixture of air and exhaust gases must be homogeneous at the point where the sampling probe is located (see 2.3.1.2).
    - 2.2.4. The probe must extract a representative sample of the diluted gases.
    - 2.2.5. The system must make it possible to measure the total volume of the diluted exhaust gases from the vehicle being tested.

Figure III.5.2.2

Diagram of variable-dilution system for measuring exhaust-gas emissions

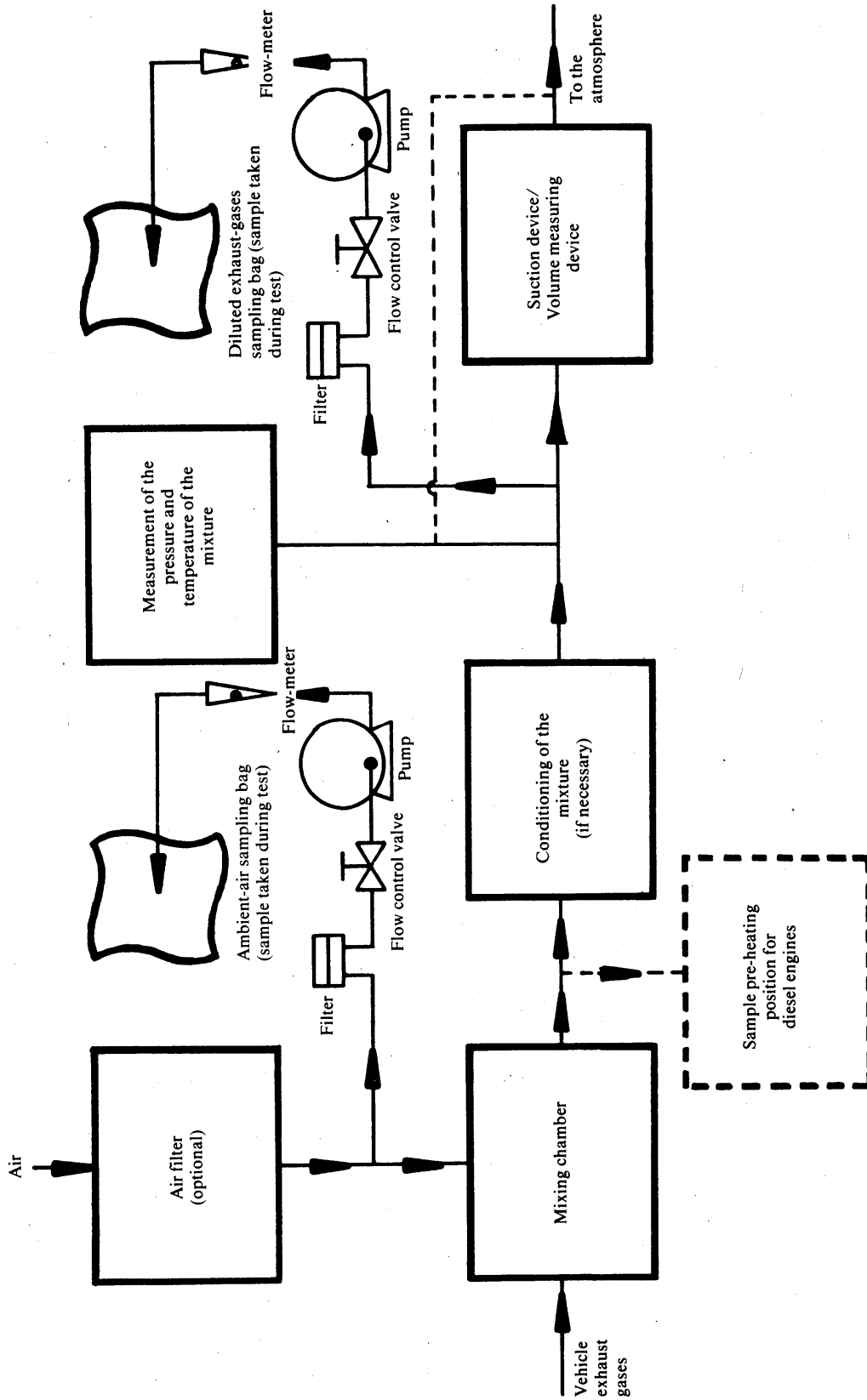

▼ **M9**

- 2.2.6. The sampling system must be gas-tight. The design of the variable-dilution sampling system and the materials that go to make it up must be such that they do not affect the pollutant concentration in the diluted exhaust gases. Should any component in the system (heat exchanger, cyclone separator, blower, etc.) change the concentration of any of the pollutants in the diluted exhaust gases and the fault cannot be corrected, then sampling for that pollutant must be carried out before that component.
- 2.2.7. If the vehicle tested is equipped with an exhaust system comprising more than one tailpipe, the connecting tubes must be connected together by a manifold installed as near as possible to the vehicle.
- 2.2.8. The gas samples must be collected in sampling bags of adequate capacity so as not to hinder the gas flow during the sampling period. These bags must be made of such materials as will not affect the concentration of pollutant gases (see 2.3.4.4).
- 2.2.9. The variable-dilution system must be so designed as to enable the exhaust gases to be sampled without appreciably changing the back-pressure at the exhaust pipe outlet (see 2.3.1.1).
- 2.3. **Specific requirements**
- 2.3.1. *Exhaust-gas collection and dilution device*
- 2.3.1.1. The connection tube between the vehicle exhaust tailpipe(s) and the mixing chamber must be as short as possible; it must in no case:
- cause the static pressure at the exhaust tailpipe(s) on the vehicle being tested to differ by more than  $\pm 0,75$  kPa at 50 km/h or more than  $\pm 1,25$  kPa for the whole duration of the test from the static pressures recorded when nothing is connected to the vehicle tailpipes. The pressure must be measured in the exhaust tailpipe or in an extension having the same diameter, as near as possible to the end of the pipe,
  - change the nature of the exhaust gas.
- 2.3.1.2. There must be a mixing chamber in which the vehicle exhaust gases and the dilution air are mixed so as to produce a homogeneous mixture at the chamber outlet.
- The homogeneity of the mixture in any cross-section at the location of the sampling probe must not vary by more than  $\pm 2$  % from the average of the values obtained at least five points) located at equal intervals on the diameter of the gas stream. In order to minimize the effects on the conditions at the exhaust tailpipe and to limit the drop in pressure inside the dilution air-conditioning device, if any, the pressure inside the mixing chamber must not differ by more than 0,25 kPa from atmospheric pressure.
- 2.3.2. *Suction device/volume measuring device*
- This device may have a range of fixed speeds so as to ensure sufficient flow to prevent any water condensation. This result is generally obtained by keeping the concentration of CO<sub>2</sub> in the dilute exhaust-gas sampling bag lower than 3 % by volume.
- 2.3.3. *Volume measurement*
- 2.3.3.1. The volume measuring device must retain its calibration accuracy to within  $\pm 2$  % under all operating conditions. If the device cannot compensate for variations in the temperature of the mixture of exhaust gases and dilution air at the measuring point, a heat exchanger must be used to maintain the temperature to within  $\pm 6$  K of the specified operating temperature.
- If necessary, a cyclone separator can be used to protect the volume measuring device.
- 2.3.3.2. A temperature sensor must be installed immediately before the volume measuring device. This temperature sensor must have an accuracy and a precision of  $\pm 1$  K and a response time of 0,1 second at 62 % of a given temperature variation (value measured in silicone oil).

**▼M9**

- 2.3.3.3. The pressure measurements must have a precision and an accuracy of  $\pm 0,4$  kPa during the test.
- 2.3.3.4. The measurement of the pressure difference from atmospheric pressure is taken before and, if necessary, after the volume measuring device.
- 2.3.4. *Gas sampling*
- 2.3.4.1. Dilute exhaust gases
- 2.3.4.1.1. The sample of dilute exhaust gases is taken before the suction device but after the conditioning devices (if any).
- 2.3.4.1.2. The flow-rate must not deviate by more than  $\pm 2$  % from the average.
- 2.3.4.1.3. The sampling rate must not fall below 5 litres per minute and must not exceed 0,2 % of the flow-rate of the dilute exhaust gases.
- 2.3.4.1.4. An equivalent limit applies to constant-mass sampling systems.
- 2.3.4.2. Dilution air
- 2.3.4.2.1. A sample of the dilution air is taken at a constant flow-rate near the ambient air inlet (after the filter if one is fitted).
- 2.3.4.2.2. The air must not be contaminated by exhaust gases from the mixing area.
- 2.3.4.2.3. The sampling rate for the dilution air must be comparable to that used in the case of the dilute exhaust gases.
- 2.3.4.3. Sampling operations
- 2.3.4.3.1. The materials used for the sampling operations must be such that they do not change the pollutant concentration.
- 2.3.4.3.2. Filters may be used in order to extract the solid particles from the sample.
- 2.3.4.3.3. Pumps are required in order to convey the sample to the sampling bag(s).
- 2.3.4.3.4. Flow control valves and flow-meters are needed in order to obtain the flow-rates required for sampling.
- 2.3.4.3.5. Quick-fastening gas-tight connections may be used between the three-way valves and the sampling bags, the connections sealing themselves automatically on the bag side. Other systems may be used for conveying the samples to the analyzer (three-way stop valves, for example).
- 2.3.4.3.6. The various valves used for directing the sampling gases must be of the quick-adjusting and quick-acting type.
- 2.3.4.4. Storage of the sample
- The gas samples are collected in sampling bags of adequate capacity so as not to reduce the sampling rate. The bags must be made of such a material as will not change the concentration of synthetic pollutant gases by more than  $\pm 2$  % after 20 minutes.
- 2.4. **Additional sampling unit for the testing of vehicles equipped with a compression-ignition engine**
- 2.4.1. By way of a departure from the taking of gas samples from vehicles equipped with spark-ignition engines, the hydrocarbon and particulate sampling points are located in a dilution tunnel.
- 2.4.2. In order to reduce heat losses in the exhaust gases between the exhaust tail pipe and the dilution tunnel inlet, the pipe may not be more than 3,6 m long, or 6,1 m long if heat insulated. Its internal diameter may not exceed 105 mm.



▼ M9

Figure III.5.2.4.4.

Particulate sampling probe configuration

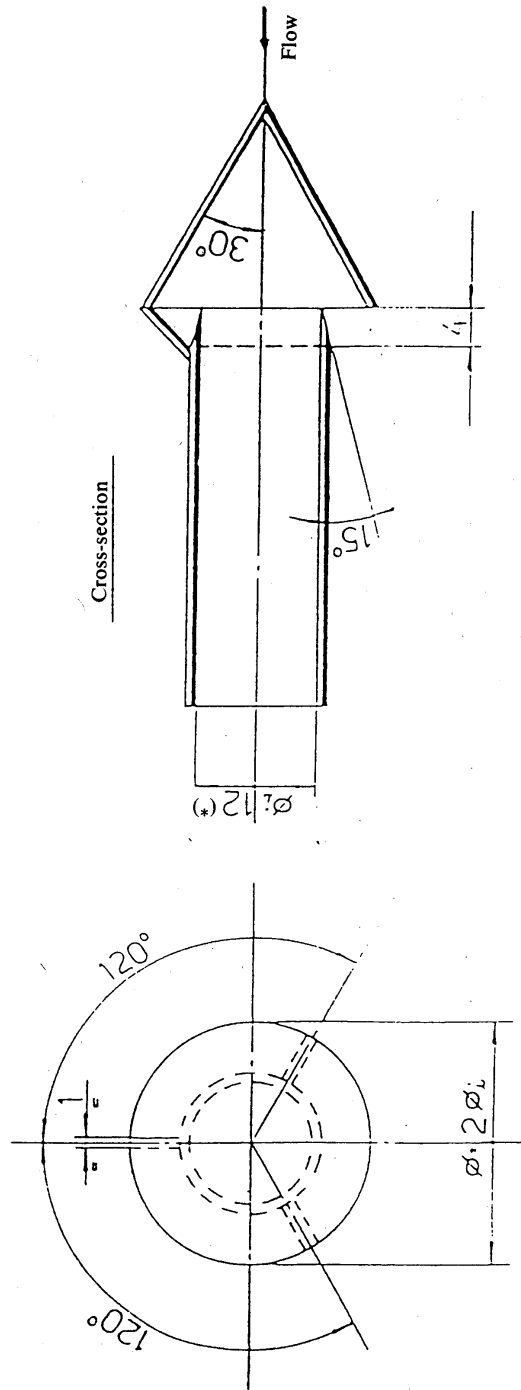

(\*) Minimum internal diameter

Wall thickness: ~ 1 mm — Material: stainless steel

▼ **M9**

- 2.4.3. Predominantly turbulent flow conditions (Reynolds number  $\geq 4\,000$ ) must apply in the dilution tunnel, which consists of a straight tube of electrically-conductive material, in order to guarantee that the diluted exhaust gas is homogeneous at the sampling points and that the samples consist of representative gases and particulates. The dilution tunnel must be at least 200 mm in diameter and the system must be earthed.
- 2.4.4. The particulate sampling system consists of a sampling probe in the dilution tunnel and two series-mounted filters. Quick-acting valves are located both up and downstream of the two filters in the direction of flow.  
The configuration of the sample probe must be as indicated in Figure III.5.2.4.4.
- 2.4.5. The particulate sampling probe must be arranged as follows:  
It must be installed in the vicinity of the tunnel centreline, roughly 10 tunnel diameters downstream of the gas inlet, and have an internal diameter of at least 12 mm.  
The distance from the sampling tip to the filter mount must be at least five probe diameters, but must not exceed 1 020 mm.
- 2.4.6. The sample gas flow measuring unit consists of pumps, gas flow regulators and flow measuring units.
- 2.4.7. The hydrocarbon sampling system consists of a heated sampling probe, line, filter and pump. The sampling probe must be installed in such a way, at the same distance from the exhaust gas inlet as the particulate sampling probe, that neither interferes with samples taken by the other. It must have a minimum internal diameter of 4 mm.
- 2.4.8. All heated parts must be maintained at a temperature of 463 K (190 °C)  $\pm 10$  K by the heating system.
- 2.4.9. If it is not possible to compensate for variations in the flow rate there must be a heat exchanger and a temperature control device as specified in 2.3.3.1 so as to ensure that the flow rate in the system is constant and the sampling rate is accordingly proportional.

## 3. DESCRIPTION OF THE DEVICES

- 3.1. **Variable dilution device with positive displacement pump (PDP-CVS)** (Figure III.5.3.1.)
- 3.1.1. The positive displacement pump — constant volume sampler (PDP-CVS) satisfies the requirements of this Annex by metering at a constant temperature and pressure through the pump. The total volume is measured by counting the revolutions made by the calibrated positive displacement pump. The proportional sample is achieved by sampling with pump, flow-meter and flow control valve at a constant flow-rate.
- 3.1.2. Figure III.5.3.1 is a schematic drawing of such a sampling system. Since various configurations can produce accurate results exact conformity with the drawing is not essential. Additional components such as instruments, valves, solenoids and switches may be used to provide additional information and coordinate the functions of the component system.
- 3.1.3. The collecting equipment consists of:
- 3.1.3.1. a filter (D) for the dilution air, which can be preheated if necessary. This filter must consist of activated charcoal sandwiched between two layers of paper, and shall be used to reduce and stabilize the hydrocarbon concentrations of ambient emissions in the dilution air;
- 3.1.3.2. a mixing chamber (M) in which exhaust gas and air are mixed homogeneously;

▼ M9

Figure III.5.3.1

Constant volume sampler with positive displacement pump (PDP-CVS)

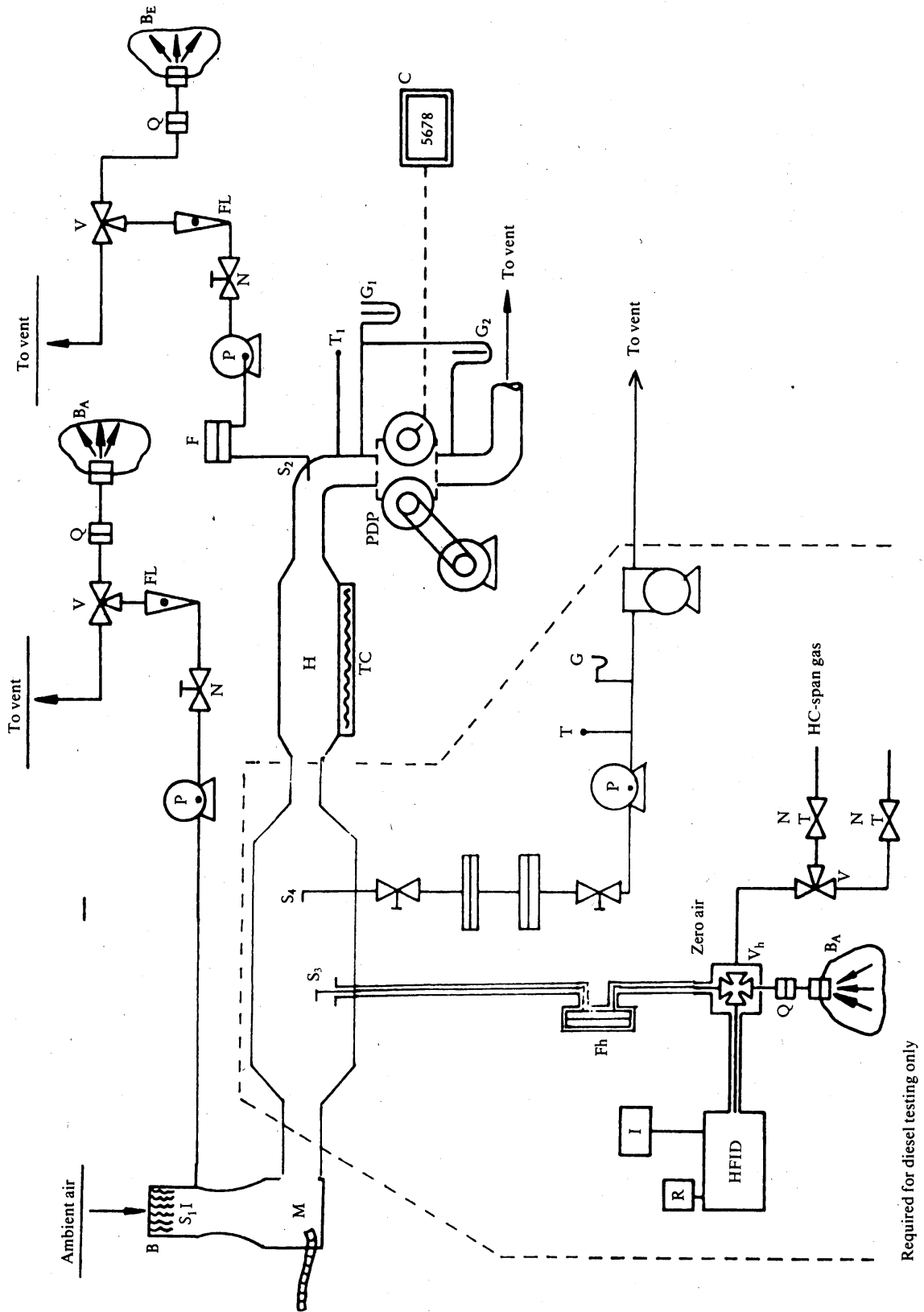

▼ M9

- 3.1.3.3. a heat exchanger (H) of a capacity sufficient to ensure that throughout the test the temperature of the air/exhaust-gas mixture measured at a point immediately upstream of the positive displacement pump is within  $\pm 6$  K of the designed operating temperature. This device must not affect the pollutant concentrations of diluted gases taken off after for analysis;
- 3.1.3.4. a temperature control system (TC), used to preheat the heat exchanger before the test and to control its temperature during the test, so that deviations from the designed operating temperature are limited to  $\pm 6$  K;
- 3.1.3.5. the positive displacement pump (PDP), used to transport a constant-volume flow of the air/exhaust-gas mixture; the flow capacity of the pump must be large enough to eliminate water condensation in the system under all operating conditions which may occur during a test; this can be generally ensured by using a positive displacement pump with a flow capacity:
- 3.1.3.5.1. — twice as high as the maximum flow of exhaust gas produced by accelerations of the driving cycle, or
- 3.1.3.5.2. — sufficient to ensure that the CO<sub>2</sub> concentration in the dilute-exhaust sample bag is less than 3 % by volume;
- 3.1.3.6. a temperature sensor (T<sub>1</sub>) (accuracy and precision  $\pm 1$  K), fitted at a point immediately upstream of the positive displacement pump; it must be designed to monitor continuously the temperature of diluted exhaust-gas mixture during the test;
- 3.1.3.7. a pressure gauge (G<sub>1</sub>) (accuracy and precision  $\pm 0,4$  kPa) fitted immediately upstream of the volume meter and used to register the pressure gradient between the gas mixture and the ambient air;
- 3.1.3.8. another pressure gauge (G<sub>2</sub>) (accuracy and precision  $\pm 0,4$  kPa) fitted so that the different pressure between pump inlet and pump outlet can be registered;
- 3.1.3.9. two sampling outlets (S<sub>1</sub> and S<sub>2</sub>) for taking constant samples of the dilution air and of the diluted exhaust-gas/air mixture;
- 3.1.3.10. a filter (F), to extract solid particles from the flows of gas collected for analysis;
- 3.1.3.11. pumps (P), to collect a constant flow of the dilution air as well as the diluted exhaust-gas/air mixture during the test;
- 3.1.3.12. flow controllers (N), to ensure a constant uniform flow of the gas samples taken during the course of the test from sampling probes S<sub>1</sub> and S<sub>2</sub>; and flow of the gas samples must be such that, at the end of each test, the quantity of the samples is sufficient for analysis ( $\sim 10$  litres per minute);
- 3.1.3.13. flow-meters (FL), for adjusting and monitoring the constant flow of gas samples during the test;
- 3.1.3.14. quick-acting valves (V), to divert a constant flow of gas samples into the sampling bags or to the outside vent;
- 3.1.3.15. gas-tight, quick-lock coupling elements (Q) between the quick-acting valves and the sampling bags; the coupling must close automatically on the sampling-bag side; as an alternative, other ways of transporting the samples to the analyzer may be used (three-way stopcocks, for instance);
- 3.1.3.16. bags (B), for collecting samples of the diluted exhaust gas and of the dilution air during the test; they must be of sufficient capacity not to impede the sample flow; the bag material must be such as to affect neither the measurements themselves nor the chemical composition of the gas samples (for instance: laminated polyethylene/polyamide films, or fluorinated polyhydrocarbons);
- 3.1.3.17. a digital counter (C), to register the number of revolutions performed by the positive displacement pump during the test;

▼ **M9**3.1.4. *Additional equipment required when testing diesel-engined vehicles*

To comply with the requirements of 4.3.1.1 and 4.3.2 of Annex III, the additional components within the dotted lines in Figure III.5.3.1 must be used when testing diesel-engined vehicles:

- F<sub>h</sub> is a heated filter,
- S<sub>3</sub> is a sample point close to the mixing chamber,
- V<sub>h</sub> is a heated multiway valve,
- Q is a quick connector to allow the ambient air sample BA to be analysed on the HFID,
- HFID is a heated flame ionization analyzer,
- R and I are means of integrating and recording the instantaneous hydrocarbon concentrations,
- L<sub>h</sub> is a heated sample line.

All heated components must be maintained at 463 K (190 °C) ± 10 K.

## Particulate sampling system

- S<sub>4</sub> sampling probe in the dilution tunnel,
- F<sub>p</sub> filter unit consisting of two series-mounted filters; switching arrangement for further parallel-mounted pairs of filters,
- sampling line,
- pumps, flow regulators, flow measuring units.

3.2. **Critical-flow venturi dilution device (CFV-CVS)** (Figure III.5.3.2.)

3.2.1. Using a critical-flow venturi in connection with the CVS sampling procedure is based on the principles of flow mechanics for critical flow. The variable mixture flow rate of dilution and exhaust gas is maintained as sonic velocity which is directly proportional to the square root of the gas temperature. Flow is continually monitored, computed and integrated over the test.

If an additional critical-flow sampling venturi is used, the proportionality of the gas samples taken is ensured. As both pressure and temperature are equal at the two venturi inlets the volume of the gas flow diverted for sampling is proportional to the total volume of diluted exhaust-gas mixture produced, and thus the requirements of this Annex are met.

3.2.2. Figure III.5.3.2 is a schematic drawing of such a sampling system. Since various configurations can produce accurate results, exact conformity with the drawing is not essential. Additional components such as instruments, valve, solenoids, and switches may be used to provide additional information and coordinate the functions of the component system.

3.2.3. The collecting equipment consists of:

- 3.2.3.1. a filter (D) for the dilution air, which can be preheated if necessary: the filter must consist of activated charcoal sandwiched between layers of paper, and must be used to reduce and stabilize the hydrocarbon background emission of the dilution air;
- 3.2.3.2. a mixing chamber (M), in which exhaust gas and air are mixed homogeneously;
- 3.2.3.3. a cyclone separator (CS), to extract particles;
- 3.2.3.4. two sampling probes (S<sub>1</sub> and S<sub>2</sub>) for taking samples of the dilution air and of the diluted exhaust gas/air mixture;
- 3.2.3.5. a sampling critical flow venturi (SV), to take proportional samples of the diluted exhaust gas at sampling probe S<sub>2</sub>;
- 3.2.3.6. a filter (F), to extract solid particles from the gas flows diverted for analysis;
- 3.2.3.7. pumps (P), to collect part of the flow of air and diluted exhaust gas in bags during the test;
- 3.2.3.8. a flow controller (N), to ensure a constant flow of the gas samples taken in the course of the test from sampling probe S<sub>1</sub>;

▼ M9

the flow of the gas samples must be such that, at the end of the test, the quantity of the samples is sufficient for analysis (10 litres per minute);

- 3.2.3.9. a snubber (PS), in the sampling line;

▼ M9

Figure III.5.3.2

Constant volume sampler with critical-flow venturi (CFV-CVS System)

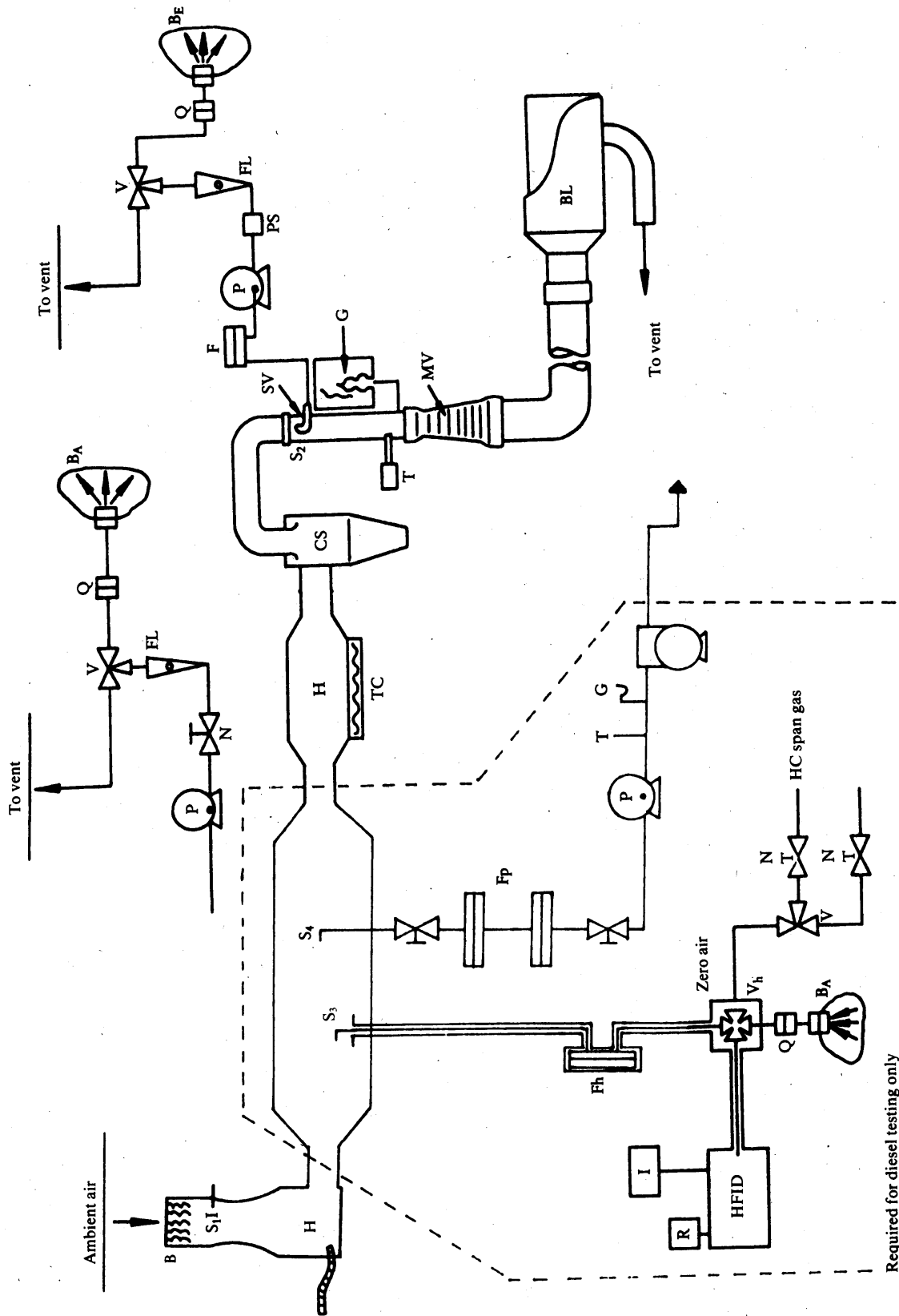

▼ M9

- 3.2.3.10. flow meters (FL), for adjusting and monitoring the flow of gas samples during tests;
- 3.2.3.11. quick-acting solenoid valves (V), to divert a constant flow of gas samples into the sampling bags or the vent;
- 3.2.3.12. gas-tight, quick-lock coupling elements (Q), between the quick-acting valves and the sampling bags; the couplings must close automatically on the sampling bag side; as an alternative, other ways of transporting the samples to the analyzer may be used (three-way stopcocks, for instance);
- 3.2.3.13. bags (B), for collecting samples of the diluted exhaust gas and the dilution air during the tests; they must be of sufficient capacity not to impede the sample flow; the bag material must be such as to affect neither the measurements themselves nor the chemical composition of the gas samples (for instance: laminated polyethylene/polyamide films, or fluorinated polyhydrocarbons);
- 3.2.3.14. a pressure gauge (G), which is precise and accurate to within  $\pm 0,4$  kPa;
- 3.2.3.15. a temperature sensor (T), which is precise and accurate to within  $\pm 1$  K and have a response time of 0,1 seconds to 62 % of a temperature change (as measured in silicon oil);
- 3.2.3.16. a measuring critical flow venturi tube (MV), to measure the flow volume of the diluted exhaust gas;
- 3.2.3.17. a blower (BL), of sufficient capacity to handle the total volume of diluted exhaust gas;
- 3.2.3.18. the capacity of the CFV-CVS system must be such that under all operating conditions which may possibly occur during a test there will be no condensation of water. This is generally ensured by using a blower whose capacity is:
- 3.2.3.18.1. twice as high as the maximum flow of exhaust gas produced by accelerations of the driving cycle, or
- 3.2.3.18.2. sufficient to ensure that the CO<sub>2</sub> concentration in the dilute exhaust sample bag is less than 3 % by volume.
- 3.2.4. *Additional equipment required when testing diesel-engined vehicles*

To comply with the requirements of 4.3.1.1 and 4.3.2 of Annex III, the additional components shown within the dotted lines of Figure III.5.3.2 must be used when testing diesel-engined vehicles:

- F<sub>h</sub> is a heated filter,
- S<sub>3</sub> is a sample point close to the mixing chamber,
- V<sub>h</sub> is a heated multiway valve,
- Q is a quick connector to allow the ambient air sample BA to be analyzed on the HFID,
- HFID is a heated flame ionization analyzer,
- R and I are a means of integrating and recording the instantaneous hydrocarbon concentrations,
- L<sub>h</sub> is a heated sample line.

All heated components must be maintained at 463 K (190 °C)  $\pm 10$  K.

If compensation for varying flow is not possible, then a heat exchanger (H) and temperature control system (TC) as described in 2.2.3 will be required to ensure constant flow through the venturi (MV) and thus proportional flow through S<sub>3</sub>.

Particulate sampling system

- S<sub>4</sub> sampling probe in dilution tunnel,
- F<sub>p</sub> filter unit consisting of two series-mounted filters; switching unit for further parallel-mounted pairs of filters,



▼ M9

sampling line,  
pumps, flow regulators, flow measuring units.

▼ M12 \_\_\_\_\_

**METHOD OF CALIBRATING THE EQUIPMENT**

1. ESTABLISHMENT OF THE CALIBRATION CURVE
  - 1.1. Each normally used operating range is calibrated in accordance with the requirements of 4.3.3 of Annex III by the following procedure:
    - 1.2. The analyzer calibration curve is established by at least five calibration points spaced as uniformly as possible. The nominal concentration of the calibration gas of the highest concentration must be not less than 80 % of the full scale.
    - 1.3. The calibration curve is calculated by the least squares method. If the resulting polynomial degree is greater than three, the number of calibration points must be at least equal to this polynomial degree plus two.
    - 1.4. The calibration curve must not differ by more than 2 % from the nominal value of each calibration gas.
    - 1.5. **Trace of the calibration curve**  
 From the trace of the calibration curve and the calibration points it is possible to verify that the calibration has been carried out correctly. The different characteristic parameters of the analyzer must be indicated, particularly:
      - the scale,
      - the sensitivity,
      - the zero point,
      - the date of carrying out the calibration.
    - 1.6. If it can be shown to the satisfaction of the technical service that alternative technology (e.g. computer, electronically controlled range switch, etc.) can give equivalent accuracy, then these alternatives may be used.
    - 1.7. **Verification of the calibration**
      - 1.7.1. Each normally used operating range must be checked prior to each analysis in accordance with the following:
        - 1.7.2. The calibration is checked by using a zero gas and a span gas whose nominal value is within 80 to 95 % of the supposed value to be analyzed.
        - 1.7.3. If, for the two points considered, the value found does not differ by more than  $\pm 5$  % of the full scale from the theoretical value, the adjustment parameters may be modified. Should this not be the case, a new calibration curve must be established in accordance with section 1.
        - 1.7.4. After testing, zero gas and the same span gas are used for re-checking. The analysis is considered acceptable if the difference between the two measuring results is less than 2 %.
2. CHECK FOR FID, HYDROCARBON RESPONSE
  - 2.1. **Detector response optimization**  
 The FID must be adjusted, as specified by the instrument manufacturer. Propane in air should be used, to optimize the response, on the most common operating range.
  - 2.2. **Calibration of the HC analyzer**  
 The analyzer should be calibrated using propane in air and purified synthetic air. See section 4.5.2 of Annex III (calibration and span gases).  
  
 Establish a calibration curve as described in sections 1.1 to 1.5 of this Appendix.

▼ **M9****2.3. Response factors of different hydrocarbons and recommended limits**

The response factor (Rf) for a particular hydrocarbon species is the ratio of the FID  $C_1$  reading to the gas cylinder concentration, expressed as ppm  $C_1$ .

The concentration of the test gas must be at a level to give a response of approximately 80 % of full scale deflection, for the operating range. The concentration must be known, to an accuracy of  $\pm 2$  % in reference to a gravimetric standard expressed in volume. In addition the gas cylinder must be pre-conditioned for 24 hours at a temperature between 293 and 303 K (20 and 30 °C).

Response factors are determined when introducing an analyzer into service and thereafter at major service intervals. The test gases to be used and the recommended response factor are:

- methane and purified air  $1,00 < Rf < 1,15$ ,
- propylene and purified air  $0,90 < Rf < 1,00$ ,
- toluene and purified air  $0,90 < Rf < 1,00$ .

Relative to a response factor (Rf) of 1,00 for propane and purified air.

**2.4. Oxygen interference check and recommended limits**

The response factor should be determined as described in 2.3. The test gas to be used and recommended response factor range are:

- Propane and nitrogen  $0,95 \leq Rf \leq 1,05$

**3. EFFICIENCY TEST OF THE  $NO_x$  CONVERTER**

The efficiency of the converter used for the conversion of  $NO_2$  into NO is tested as follows:

Using the test set up as shown in Figure III.6.3 and the procedure described below, the efficiency of converters can be tested by means of an ozonator.

- 3.1. Calibrate the CLA in the most common operating range following the manufacturer's specifications using zero and span gas (the NO content of which must amount to about 80 % of the operating range and the  $NO_2$  concentration of the gas mixture to less than 5 % of the NO concentration). The  $NO_x$  analyzer must be in the NO mode so that the span gas does not pass through the converter. Record the indicated concentration.
- 3.2. Via a T-fitting, oxygen or synthetic air is added continuously to the gas flow until the concentration indicated is about 10 % less than the indicated calibration concentration given in 3.1. Record the indicated concentration (C). The ozonator is kept deactivated throughout this process.
- 3.3. The ozonator is now activated to generate enough ozone to bring the NO concentration down to 20 % (minimum 10 %) of the calibration concentration given in 3.1. Record the indicated concentration (d).
- 3.4. The  $NO_x$  analyzer is then switched to the  $NO_x$  mode which means that the gas mixture (consisting of NO,  $NO_2$ ,  $O_2$  and  $N_2$ ) now passes through the converter. Record the indicated concentration (a).
- 3.5. The ozonator is now deactivated. The mixture of gases described in 3.2 passes through the converter into the detector. Record the indicated concentration (b).
- 3.6. With the ozonator deactivated, the flow of oxygen or synthetic air is also shut off. The  $NO_x$  reading of the analyzer must then be no more than 5 % above the figure given in 3.1.

## ▼ M9

3.7. The efficiency of the NO<sub>x</sub> converter is calculated as follows:

$$\text{Efficiency (\%)} = \left(1 + \frac{a-b}{c-d}\right) \cdot 100$$

Figure III.6.3

Diagram of NO<sub>x</sub> converter efficiency device

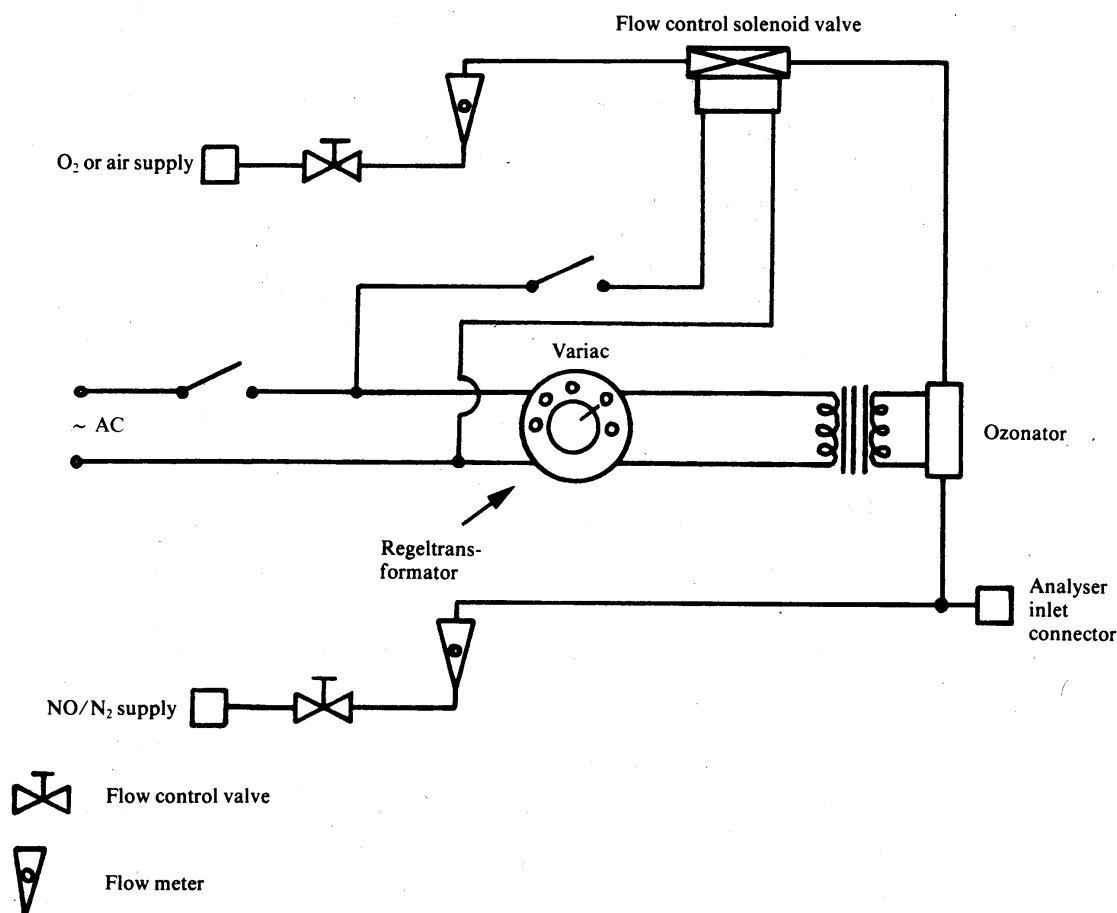

3.8. The efficiency of the converter must not be less than 95 %.

3.9. The efficiency of the converter must be tested at least once a week.

#### 4. CALIBRATION OF THE CVS SYSTEM

4.1. The CVS system must be calibrated by using an accurate flow-meter and a restricting device. The flow through the system must be measured at various pressure readings and the control parameters of the system measured and related to the flows.

4.1.1. Various types of flow-meter may be used, e.g. calibrated venturi, laminar flow-meter, calibrated turbine-meter, provided that they are dynamic measurement systems and can meet the requirements of sections 4.2.2 and 4.2.3 of Annex III.

4.1.2. The following sections give details of methods of calibrating PDP and CFV units, using a laminar flow-meter, which gives the required accuracy, together with a statistical check on the calibration validity.

#### 4.2. Calibration of the positive displacement pump (PDP)

4.2.1. The following calibration procedure outlines the equipment, the test configuration and the various parameters which are measured to establish the flow-rate of the CVS pump. All the parameters

▼ **M9**

related to the pump are simultaneously measured with the parameters related to the flow-meter which is connected in series with the pump. The calculated flow-rate (given in m<sup>3</sup>/min at pump inlet, absolute pressure and temperature) can then be plotted versus a correlation function which is the value of a specific combination of pump parameters. The linear equation which relates the pump flow and the correlation function is then determined. In the event that a CVS has a multiple speed drive, a calibration for each range used must be performed.

- 4.2.2. This calibration procedure is based on the measurement of the absolute values of the pump and flow-meter parameters that relate the flow-rate at each point. Three conditions must be maintained to ensure the accuracy and integrity of the calibration curve.
- 4.2.2.1. The pump pressures must be measured at tapings on the pump rather than at the external piping on the pump inlet and outlet. Pressure taps that are mounted at the top centre and bottom centre of the pump drive headplate are exposed to the actual pump cavity pressures, and therefore reflect the absolute pressure differentials.
- 4.2.2.2. Temperature stability must be maintained during the calibration. The laminar flow-meter is sensitive to inlet temperature oscillations which cause the data points to be scattered. Gradual changes of  $\pm 1$  K in temperature are acceptable as long as they occur over a period of several minutes.
- 4.2.2.3. All connections between the flow-meter and the CVS pump must be free of any leakage.
- 4.2.3. During an exhaust emission test, the measurement of these same pump parameters enables the user to calculate the flow-rate from the calibration equation.
- 4.2.3.1. Figure III.6.4.2.3.1 of this Appendix shows one possible test set-up. Variations are permissible, provided that they are approved by the authority granting the approval as being of comparable accuracy. If the set-up shown in Figure III.5.3.2 of Appendix 5 is used, the following data must be found within the limits of precision given:
- |   |                  |
|---|------------------|
| barometric pressure (corrected) (PB)        | $\pm 0,03$ kPa   |
| ambient temperature (T)                     | $\pm 0,2$ K      |
| air temperature at LFE (ETI)                | $\pm 0,15$ K     |
| pressure depression upstream of LFE (EPI)   | $\pm 0,01$ kPa   |
| pressure drop across the LFE matrix (EDP)   | $\pm 0,0015$ kPa |
| air temperature at CVS pump inlet (PTI)     | $\pm 0,2$ K      |
| air temperature at CVS pump outlet (PTO)    | $\pm 0,2$ K      |
| pressure depression at CVS pump inlet (PPI) | $\pm 0,22$ kPa   |
| pressure head at CVS pump outlet (PPO)      | $\pm 0,22$ kPa   |
| pump revolutions during test period (n)     | $\pm 1$ rev      |
| elapsed time for period (minimum 250 s) (t) | $\pm 0,1$ s.     |
- 4.2.3.2. After the system has been connected as shown in Figure III.6.4.2.3.1, set the variable restrictor in the wide-open position and run the CVS pump for 20 minutes before starting the calibration.
- 4.2.3.3. Reset the restrictor valve to a more restricted condition in an increment of pump inlet depression (about 1 kPa) that will yield a minimum of six data points for the total calibration. Allow the system to stabilize for three minutes and repeat the data acquisition.

▼ M9

Figure III.6.4.2.3.1

## PDP-CVS calibration configuration

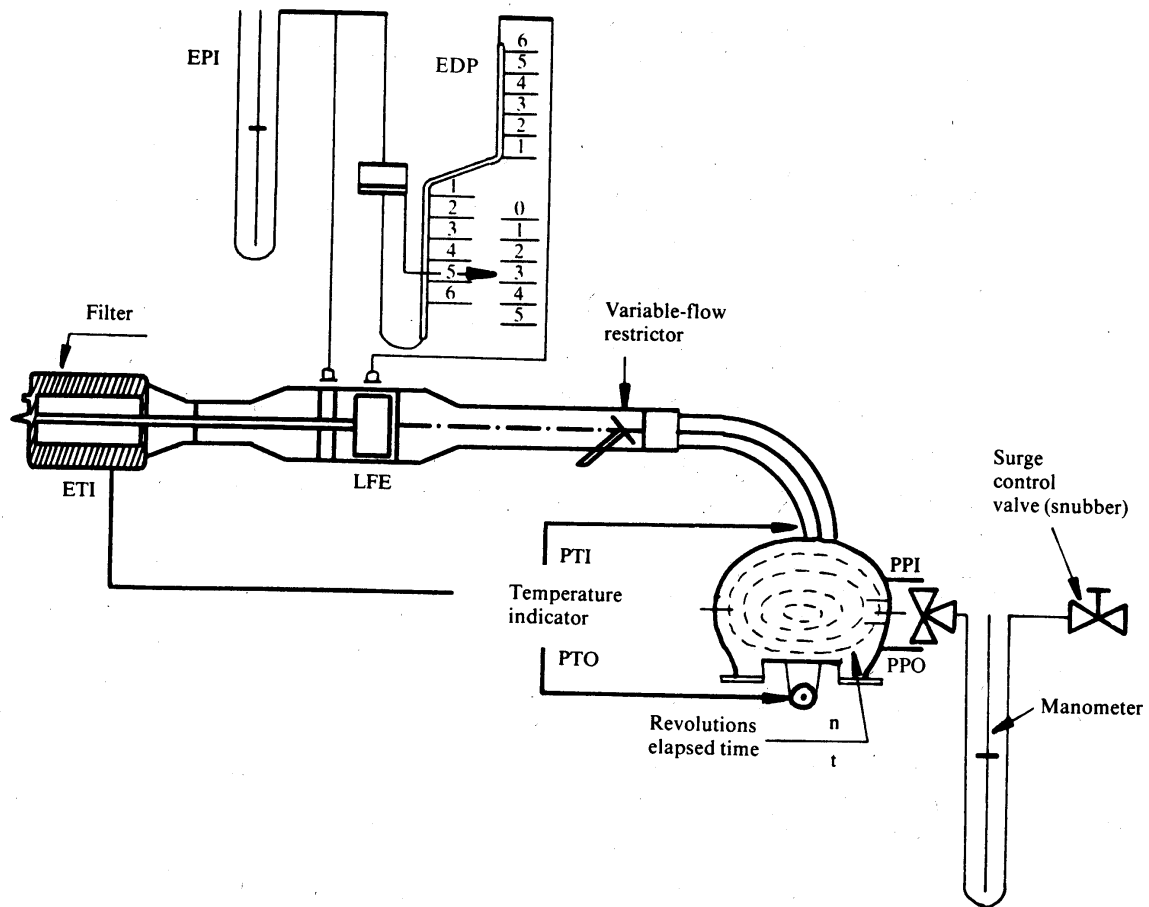

## 4.2.4. Data analysis

4.2.4.1. The air flow-rate ( $Q_s$ ) at each test point is calculated in standard  $\text{m}^3/\text{min}$  from the flow-meter data using the manufacturer's prescribed method.

4.2.4.2. The air flow-rate is then converted to pump flow ( $V_o$ ) in  $\text{m}^3/\text{rev}$  at absolute pump inlet temperature and pressure.

$$V_o = \frac{Q_s}{n} \cdot \frac{T_p}{273,2} \cdot \frac{101,33}{P_p}$$

where:

$V_o$  = pump flow-rate at  $T_p$  and  $P_p$  given in  $\text{m}^3/\text{rev}$ ,

$Q_s$  = air flow at 101,33 kPa and 273,2 K given in  $\text{m}^3/\text{min}$ ,

$T$  = pump inlet temperature (K),

$P_p$  = absolute pump inlet pressure,

$n$  = pump speed in revolutions per minute.

To compensate for the interaction of pump speed pressure variations at the pump and the pump slip rate, the correlation function ( $X_o$ ) between the pump speed ( $n$ ), the pressure differential from pump inlet to pump outlet and the absolute pump outlet pressure is then calculated as follows:

$$X_o = \frac{1}{n} \sqrt{\frac{\Delta P_p}{P_e}}$$

▼ **M9**

where:

$X_o$  = correlation function,

$\Delta P_p$  = pressure differential from pump inlet to pump outlet (kPa),

$P_e$  = absolute outlet pressure ( $PPO + P_B$ ) (kPa).

A linear least-square fit is performed to generate the calibration equations which have the formulae:

$$V_o = D_o - M (X_o)$$

$$n = A - B (\Delta P_p)$$

$D_o$ ,  $M$ ,  $A$  and  $B$  are the slope-intercept constants describing the lines.

- 4.2.4.3. A CVS system that has multiple speeds must be calibrated on each speed used. The calibration curves generated for the ranges must be approximately parallel and the intercept values ( $D_o$ ) must increase as the pump flow range decreases.

If the calibration has been performed carefully, the calculated values from the equation will be within  $\pm 0,5$  % of the measured value of  $V_o$ . Values of  $M$  will vary from one pump to another. Calibration is performed at pump start-up and after major maintenance.

4.3. **Calibration of the critical-flow venturi (CFV)**

- 4.3.1. Calibration of the CFV is based upon the flow equation for a critical venturi:

$$Q_s = \frac{K_v \cdot P}{\sqrt{T}}$$

where:

$Q_s$  = flow,

$K_v$  = calibration coefficient,

$P$  = absolute pressure (kPa),

$T$  = absolute temperature (K).

Gas flow is a function of inlet pressure and temperature.

The calibration procedure described below establishes the value of the calibration coefficient at measured values of pressure, temperature and air flow.

- 4.3.2. The manufacturer's recommended procedure must be followed for calibrating electronic portions of the CFV.

- 4.3.3. Measurements for flow calibration of the critical flow venturi are required and the following data must be found within the limits of precision given:

barometric pressure (corrected) ( $P_B$ )	$\pm 0,03$ kPa,
LFE air temperature, flow-meter (ETI)	$\pm 0,15$ K,
pressure depression upstream of LFE (EPI)	$\pm 0,01$ kPa,
pressure drop across (EDP) LFE matrix	$\pm 0,0015$ kPa,
air flow ( $Q_s$ )	$\pm 0,5$ %,
CFV inlet depression (PPI)	$\pm 0,02$ kPa,
temperature at venturi inlet ( $T_v$ )	$\pm 0,2$ K.

- 4.3.4. The equipment must be set up as shown in Figure III.6.4.3.4 and checked for leaks. Any leaks between the flow-measuring device and the critical-flow venturi seriously affect the accuracy of the calibration.

▼ M9

Figure III.6.4.3.4

## CFV-CVS calibration configuration

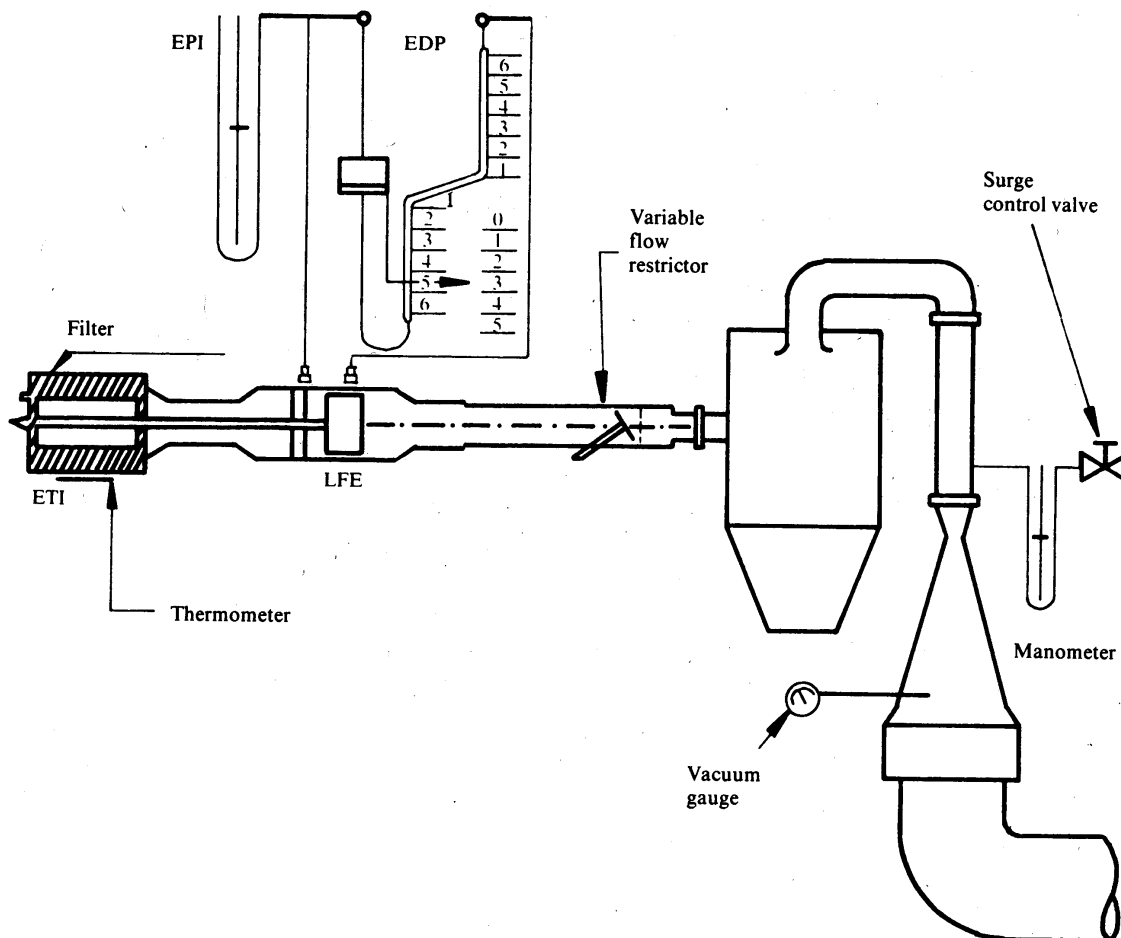

- 4.3.5. The variable-flow restrictor must be set to the open position, the blower started and the system stabilized. Data from all instruments must be recorded.
- 4.3.6. The flow restrictor must be varied and at least eight readings across the critical flow range of the venturi must be made.
- 4.3.7. The data recorded during the calibration must be used in the following calculations. The air flow-rate ( $Q_s$ ) at each test point is calculated from the flow-meter data using the manufacturer's prescribed method.

Calculate values of the calibration coefficient for each test point:

$$K_v = \frac{Q_s \cdot \sqrt{T_v}}{P_v}$$

where:

$Q_s$  = flow-rate in m/min at 273,2 K and 101,33 kPa,

$T_v$  = temperature at the venturi inlet (K),

$P_v$  = absolute pressure at the venturi inlet (kPa).

Plot  $K_v$  as a function of venturi inlet pressure. For sonic flow  $K_v$  will have a relatively constant value. As pressure decreases (vacuum increases) the venturi become unchoked and  $K_v$  decreases. The resultant  $K_v$  changes are not permissible.

For a minimum of eight points and the critical region calculate an average  $K_v$  and the standard deviation.

If the standard deviation exceeds 0,3 % of the average  $K_v$  take corrective action.



▼ **M9***Appendix 7***TOTAL SYSTEM VERIFICATION**

1. To comply with the requirements of section 4.7 of Annex III, the total accuracy of the CVS sampling system and analytical system must be determined by introducing a known mass of a pollutant gas into the system whilst it is being operated as if during a normal test and then analyzing and calculating the pollutant mass according to the formulae in Appendix 8 to this Annex except that the density of propane is taken as 1,967 grams per litre at standard conditions. The following two techniques are known to give sufficient accuracy.
2. Metering a constant flow of pure gas (CO or C<sub>3</sub>H<sub>8</sub>) using a critical-flow orifice device
- 2.1. A known quantity of pure gas (CO or C<sub>3</sub>H<sub>8</sub>) is fed into the CVS system through the calibrated critical orifice. If the inlet pressure is high enough, the flow-rate (q), which is adjusted by means of the critical-flow orifice, is independent of orifice outlet pressure (critical flow). If deviations exceeding 5 % occur, the cause of the malfunction must be located and determined. The CVS system is operated as in an exhaust emission test for about 5 to 10 minutes. The gas collected in the sampling bag is analyzed by the usual equipment and the results compared to the concentration of the gas samples which was known beforehand.
3. Metering a limited quantity of pure gas (CO or C<sub>3</sub>H<sub>8</sub>) by means of a gravimetric technique
- 3.1. The following gravimetric procedure may be used to verify the CVS system. The weight of a small cylinder filled with either carbon monoxide or propane is determined with a precision of ± 0,01 gram. For about 5 to 10 minutes, the CVS system is operated as in a normal exhaust emission test, while CO or propane is injected into the system. The quantity of pure gas involved is determined by means of differential weighting. The gas accumulated in the bag is then analyzed by means of the equipment normally used for exhaust-gas analysis. The results are then compared to the concentration figures computed previously.

▼ **M9***Appendix 8***CALCULATION OF THE EMISSION OF POLLUTANTS**

## 1. GENERAL

- 1.1. Emissions of gaseous pollutants are calculated by means of the following equation:

$$M_i = \frac{V_{\text{mix}} \cdot Q_i \cdot k_H \cdot C_i \cdot 10^{-6}}{d} \quad (1)$$

where:

- $M_i$  = mass emission of the pollutant  $i$  in grams per kilometre,  
 $V_{\text{mix}}$  = volume of the diluted exhaust gas expressed in litres per test and corrected to standard conditions (273,2 K and 101,33 kPa),  
 $Q_i$  = density of the pollutant  $i$  in grams per litre at normal temperature and pressure (273,2 K and 101,33 kPa),  
 $k_H$  = humidity correction factor used for the calculation of the mass emissions of oxides of nitrogen (there is no humidity correction for HC and CO),  
 $C_i$  = concentration of the pollutant  $i$  in the diluted exhaust gas expressed in ppm and corrected by the amount of the pollutant  $i$  contained in the dilution air,  
 $d$  = actual distance corresponding to the operating cycle in km.

1.2. **Volume determination**

- 1.2.1. Calculation of the volume when a variable dilution device with constant flow control by orifice or venturi is used. Record continuously the parameters showing the volumetric flow, and calculate the total volume for the duration of the test.
- 1.2.2. Calculation of volume when a positive displacement pump is used. The volume of diluted exhaust gas in systems comprising a positive displacement pump is calculated with the following formula:

$$V = V_o \cdot N$$

where:

- $V$  = volume of the diluted exhaust gas expressed in litres per test (prior to correction),  
 $V_o$  = volume of gas delivered by the positive displacement pump on testing conditions in litres per revolution,  
 $N$  = number of revolutions per test.
- 1.2.3. Correction of the diluted exhaust-gas volume to standard conditions. The diluted exhaust-gas volume is corrected by means of the following formula:

$$V_{\text{mix}} = V \cdot K_1 \cdot \frac{P_B - P_1}{T_p} \quad (2)$$

in which:

$$K_1 = \frac{273,2 \text{ K}}{101,33 \text{ kPa}} = 2,6961 \text{ (K} \cdot \text{kPa}^{-1}\text{)} \quad (3)$$

where:

- $P_B$  = barometric pressure in the test room in kPa,  
 $P_1$  = vacuum at the inlet to the positive displacement pump in kPa relative to the ambient barometric pressure,  
 $T_p$  = average temperature of the diluted exhaust gas entering the positive displacement pump during the test (K).

**▼ M9**1.3. **Calculation of the corrected concentration of pollutants in the sampling bag**

$$C_i = C_e - C_d \left( 1 - \frac{1}{DF} \right) \quad (4)$$

where:

$C_i$  = concentration of the pollutant  $i$  in the diluted exhaust gas, expressed in ppm and corrected by the amount of  $i$  contained in the dilution air,

$C_e$  = measured concentration of pollutant  $i$  in the diluted exhaust gas, expressed in ppm,

$C_d$  = measured concentration of pollutant  $i$  in the air used for dilution, expressed in ppm,

DF = dilution factor.

The dilution factor is calculated as follows:

$$DF = \frac{13,4}{c_{CO_2} + (c_{HC} + c_{CO}) 10^{-4}} \quad (5)$$

in this equation:

$C_{CO_2}$  = concentration of  $CO_2$  in the diluted exhaust gas contained in the sampling bag, expressed in % volume,

$C_{HC}$  = concentration of HC in the diluted exhaust gas contained in the sampling bag, expressed in ppm carbon equivalent,

$C_{CO}$  = concentration of CO in the diluted exhaust gas contained in the sampling bag, expressed in ppm.

1.4. **Determination of the NO humidity correction factor**

In order to correct the influence of humidity on the results of oxides of nitrogen, the following calculations are applied:

$$k_H = \frac{1}{1 - 0,0329 (H - 10,71)} \quad (6)$$

in which:

$$H = \frac{6,211 \cdot R_a \cdot P_d}{P_B - P_d \cdot R_a \cdot 10^{-2}}$$

where:

$H$  = absolute humidity expressed in grams of water per kilogram of dry air,

$R_a$  = relative humidity of the ambient air expressed as a percentage,

$P_d$  = saturation vapour pressure at ambient temperature expressed in kPa,

$P_B$  = atmospheric pressure in the room, expressed in kPa.

1.5. **Example**1.5.1. *Data*

## 1.5.1.1. Ambient conditions:

ambient temperature: 23 °C = 296,2 K,

barometric pressure:  $P_B = 101,33$  kPa,

relative humidity:  $R_a = 60$  %,

**▼ M12**

saturation vapour pressure:  $P_d = 2,81$  kPa of  $H_2O$  at 23 °C.

▼ **M9**

- 1.5.1.2. Volume measured and reduced to standard conditions (paragraph 1)

$$V = 51,961 \text{ m}^3$$

- 1.5.1.3. Analyzer readings:

	Diluted exhaust	Dilution-air
HC (1)	92 ppm	3,0 ppm
CO	470 ppm	0 ppm
NO <sub>x</sub>	70 ppm	0 ppm
CO <sub>2</sub>	1,6 % vol	0,03 % vol

(1) In ppm carbon equivalent.

- 1.5.2. *Calculation*

▼ **M12**

- 1.5.2.1. Humidity correction factor ( $K_H$ ) (see formula (6))

$$H = \frac{6,211 \cdot R_a \cdot P_d}{P_B - P_d \cdot R_a \cdot 10^{-2}}$$

$$H = \frac{6,211 \cdot 60 \cdot 3,2}{101,33 - (2,81 \cdot 0,6)}$$

$$H = 10,5092$$

$$k_H = \frac{1}{1 - 0,0329 \cdot (H - 10,71)}$$

$$k_H = \frac{1}{1 - 0,0329 \cdot (10,5092 - 10,71)}$$

$$k_H = 0,9934$$

▼ **M9**

- 1.5.2.2. Dilution factor (DF) (see formula (5))

$$DF = \frac{13,4}{C_{CO_2} + (C_{HC} + C_{CO}) \cdot 10^{-4}}$$

$$DF = \frac{13,4}{1,6 + (92 + 4,70) \cdot 10^{-4}}$$

$$DF = 8,091$$

- 1.5.2.3. Calculation of the corrected concentration of pollutants in the sampling bag:

HC, mass emissions (see formulae (4) and (1))

$$C_i = C_e - C_d \left( 1 - \frac{1}{DF} \right)$$

$$C_i = 92 - 3 \left( 1 - \frac{1}{8,091} \right)$$

$$C = 89,371$$

$$M_{HC} = C_{HC} \cdot V_{mix} \cdot Q_{HC} \cdot \frac{1}{d}$$

$$Q_{HC} = 0,619$$

$$M_{HC} = 89,371 \cdot 51,961 \cdot 0,619 \cdot 10^{-6} \cdot \frac{1}{d}$$

**▼ M9**

$$M_{\text{HC}} = \frac{2,88}{d} \text{ g/km}$$

CO, mass emissions (see formula (1))

$$M_{\text{CO}} = C_{\text{CO}} \cdot V_{\text{mix}} \cdot Q_{\text{CO}} \cdot \frac{1}{d}$$

$$Q_{\text{CO}} = 1,25$$

$$M_{\text{CO}} = 470 \cdot 51,961 \cdot 1,25 \cdot 10^{-6} \cdot \frac{1}{d}$$

$$M_{\text{CO}} = \frac{30,5}{d} \text{ g/km}$$

NO<sub>x</sub> mass emissions (see formula (1))

$$M_{\text{NO}_x} = C_{\text{NO}_x} \cdot V_{\text{mix}} \cdot Q_{\text{NO}_x} \cdot k_{\text{H}} \cdot \frac{1}{d}$$

$$Q_{\text{NO}_x} = 2,05$$

**▼ M12**

$$M_{\text{NOX}} = 70 \cdot 51961 \cdot 2,05 \cdot 0,9934 \cdot 10^{-6} \cdot \frac{1}{d}$$

$$M_{\text{NOX}} = \frac{7,41}{d} \text{ g/km}$$

**▼ M9**

2. SPECIAL PROVISIONS RELATING TO VEHICLES  
EQUIPPED WITH COMPRESSION-IGNITION ENGINES

2.1. **HC measurement for compression-ignition engines**

The average HC concentration used in determining the HC mass emissions from compression-ignition engines is calculated with the aid of the following formula:

$$c_e = \frac{\int_{t_1}^{t_2} c_{\text{HC}} \cdot dt}{t_2 - t_1} \quad (7)$$

where:

$\int_{t_1}^{t_2} C_{\text{HC}} \cdot dt$  = integral of the recording of the heated FID over the test ( $t_2 - t_1$ ),

$C_e$  = concentration of HC measured in the diluted exhaust in ppm of  $C_p$

$C_i$  is substituted directly for  $C_{\text{HC}}$  in all relevant equations.

2.2. **Determination of particulates**

Particulate emission  $M_p$  (g/km) is calculated by means of the following equation:

$$M_p = \frac{(V_{\text{mix}} + V_{\text{ep}}) \cdot P_e}{V_{\text{ep}} \cdot d}$$

where exhaust gases are vented outside tunnel,

$$M_p = \frac{V_{\text{mix}} \cdot P_e}{V_{\text{ep}} \cdot d}$$

where exhaust gases are returned to the tunnel,

**▼M9**

where:

- $V_{\text{mix}}$ : volume of diluted exhaust gases (see 1.1), under standard conditions,
- $V_{\text{ep}}$ : volume of exhaust gas flowing through particulate filter under standard conditions,
- $P_e$ : particulate mass collected by filters,
- $d$ : actual distance corresponding to the operating cycle in km,
- $M_p$ : particulate emission in g/km.

**▼ M9***ANNEX IV***TYPE II TEST****(Carbon monoxide emission test at idling speed)**

## 1. INTRODUCTION

This Annex describes the procedure for the type II test defined in 5.3.2 of Annex I.

## 2. CONDITIONS OF MEASUREMENT

2.1. The fuel must be the reference fuel, specifications for which are given in Annex VIII.

**▼ M10**

2.2. During the test, the environmental temperature must be between 293 and 303 K (20 and 30 °C).

The engine shall be warmed up until all temperatures of cooling and lubrication means and the pressure of lubrication means have reached equilibrium.

**▼ M9**

2.3. In the case of vehicles with manually operated or semi-automatic-shift gearboxes the test must be carried out with the gear lever in the 'neutral' position and with the clutch engaged.

2.4. In the case of vehicles with automatic gear-boxes the test is carried out with the gear selector in either the 'neutral' or the 'parking' position.

2.5. **Components for adjusting the idling speed**2.5.1. *Definition*

For the purposes of this Directive, 'components for adjusting the idling speed' means controls for changing the idling conditions of the engine which may be easily operated by a mechanic using only the tools described in 2.5.1.1. In particular, devices for calibrating fuel and air flows are not considered as adjustment components if their setting requires the removal of the set-stops, an operation which cannot normally be performed except by a professional mechanic.

2.5.1.1. Tools which may be used to control components for adjusting the idling speed: screwdrivers (ordinary or cross-headed), spanners (ring, open-end or adjustable), pliers, Allen keys.

2.5.2. *Determination of measurement points***▼ M10**

2.5.2.1. A measurement at the setting in accordance with the conditions fixed by the manufacturer is performed first.

**▼ M9**

2.5.2.2. For each adjustment component with a continuous variation, a sufficient number of characteristic positions are determined.

2.5.2.3. The measurement of the carbon-monoxide content of exhaust gases must be carried out for all the possible positions of the adjustment components, but for components with a continuous variation only the positions defined in 2.5.2.2 are adopted.

2.5.2.4. The type II test is considered satisfactory if at least one of the two following conditions is met:

2.5.2.4.1. none of the values measured in accordance with 2.5.2.3 exceeds the limit values;

2.5.2.4.2. the maximum content obtained by continuously varying one of the adjustment components while the other components are kept stable does not exceed the limit value, this condition being met for the various combinations of adjustment components other than the one which was varied continuously.

2.5.2.5. The possible positions of the adjustment components are limited:

**▼M9**

- 2.5.2.5.1. on the one hand, by the larger of the following two values: the lowest idling speed which the engine can reach; the speed recommended by the manufacturer, minus 100 revolutions per minute;
- 2.5.2.5.2. on the other hand, by the smallest of the following three values: the highest speed the engine can attain by activation of the idling speed components; the speed recommended by the manufacturer, plus 250 revolutions per minute; the cut-in speed of automatic clutches.
- 2.5.2.6. In addition, settings incompatible with correct running of the engine must not be adopted as measurement settings. In particular, when the engine is equipped with several carburettors all the carburettors must have the same setting.

### 3. SAMPLING OF GASES

- 3.1. The sampling probe is placed in the pipe connecting the exhaust with the sampling bag and as close as possible to the exhaust.
- 3.2. The concentration in CO ( $C_{CO}$ ) and CO<sub>2</sub> ( $C_{CO_2}$ ) is determined from the measuring instrument readings or recordings, by use of appropriate calibration curves.
- 3.3. The corrected concentration for carbon monoxide regarding four-stroke engines is:

$$C_{COcorr} = C_{CO} \frac{15}{C_{CO} + C_{CO_2}} \text{ (Vol. \%)}$$

- 3.4. The concentration in  $C_{CO}$  (see 3.2) measured according to the formulae contained in 3.3 need not be corrected if the total of the concentrations measured ( $C_{CO} + C_{CO_2}$ ) is at least 15 for four-stroke engines.



▼ **M9**

## ANNEX V

**TYPE III TEST****(Verifying emissions of crankcase gases)**

## 1. INTRODUCTION

This Annex describes the procedure for the type III test defined in section 5.3.3 of Annex I.

## 2. GENERAL PROVISIONS

▼ **M10**

- 2.1. The type III test is carried out on the vehicle with a positive-ignition engine which has been subjected to the type I or type III test as applicable.

▼ **M9**

- 2.2. The engines tested must include leak-proof engines other than those so designed that even a slight leak may cause unacceptable operating faults (such as flat-twin engines).

## 3. TEST CONDITIONS

- 3.1. Idling must be regulated in conformity with the manufacturer's recommendations.

- 3.2. The measurements are performed in the following three sets of conditions of engine operation:

Condition No	Vehicle speed (km/h)
1	Idling
2	50 ± 2 (in 3rd gear or 'drive')
3	50 ± 2 (in 3rd gear or 'drive')

Condition No	Power absorbed by brake
1	Nil
2	That corresponding to the settings for ► <b>M12</b> type I test at 50 km/h ◀
3	That for conditions No 2, multiplied by a factor of 1,7

## 4. TEST METHOD

- 4.1. For the operation conditions as listed in 3.2 reliable function of the crankcase ventilation system must be checked.

5. METHOD OF VERIFICATION OF THE CRANKCASE VENTILATION SYSTEM  
(Refer also to Figure V.5.)

- 5.1. The engine's apertures must be left as found.
- 5.2. The pressure in the crankcase is measured at an appropriate location. It is measured at the dipstick hole with an inclined-tube manometer.
- 5.3. The vehicle is deemed satisfactory if, in every condition of measurement defined in 3.2, the pressure measured in the crankcase does not exceed the atmospheric pressure prevailing at the time of measurement.
- 5.4. For the test by the method described above, the pressure in the intake manifold is measured to within ± 1 kPa.
- 5.5. The vehicle speed as indicated at the dynamometer is measured to within ± 2 km/h.

**▼M9**

- 5.6. The pressure measured in the crankcase is measured to within  $\pm 0,01$  kPa.
- 5.7. If in one of the conditions of measurement defined in 3.2 the pressure measured in the crankcase exceeds the atmospheric pressure, an additional test as defined in section 6 is performed if so requested by the manufacturer.
6. **ADDITIONAL TEST METHOD**
  - 6.1. The engine's apertures must be left as found.
  - 6.2. A flexible bag impervious to crankcase gases and having a capacity of approximately five litres is connected to the dipstick hole. The bag must be empty before each measurement.
  - 6.3. The bag must be closed before each measurement. It must be opened to the crankcase for five minutes for each condition of measurement prescribed in 3.2.
  - 6.4. The vehicle is deemed satisfactory if in every condition of measurement defined in 3.2 no visible inflation of the bag occurs.
  - 6.5. **Remark**
    - 6.5.1. If the structural layout of the engine is such that the test cannot be performed by the methods described in section 6, the measurements must be effected by that method modified as follows:
      - 6.5.2. before the test, all apertures other than that required for the recovery of the gases are closed;
      - 6.5.3. the bag is placed on a suitable take-off which does not introduce any additional loss of pressure and is installed on the recycling circuit of the device directly at the engine-connection aperture.

▼M9

Figure V.5.  
Type III test

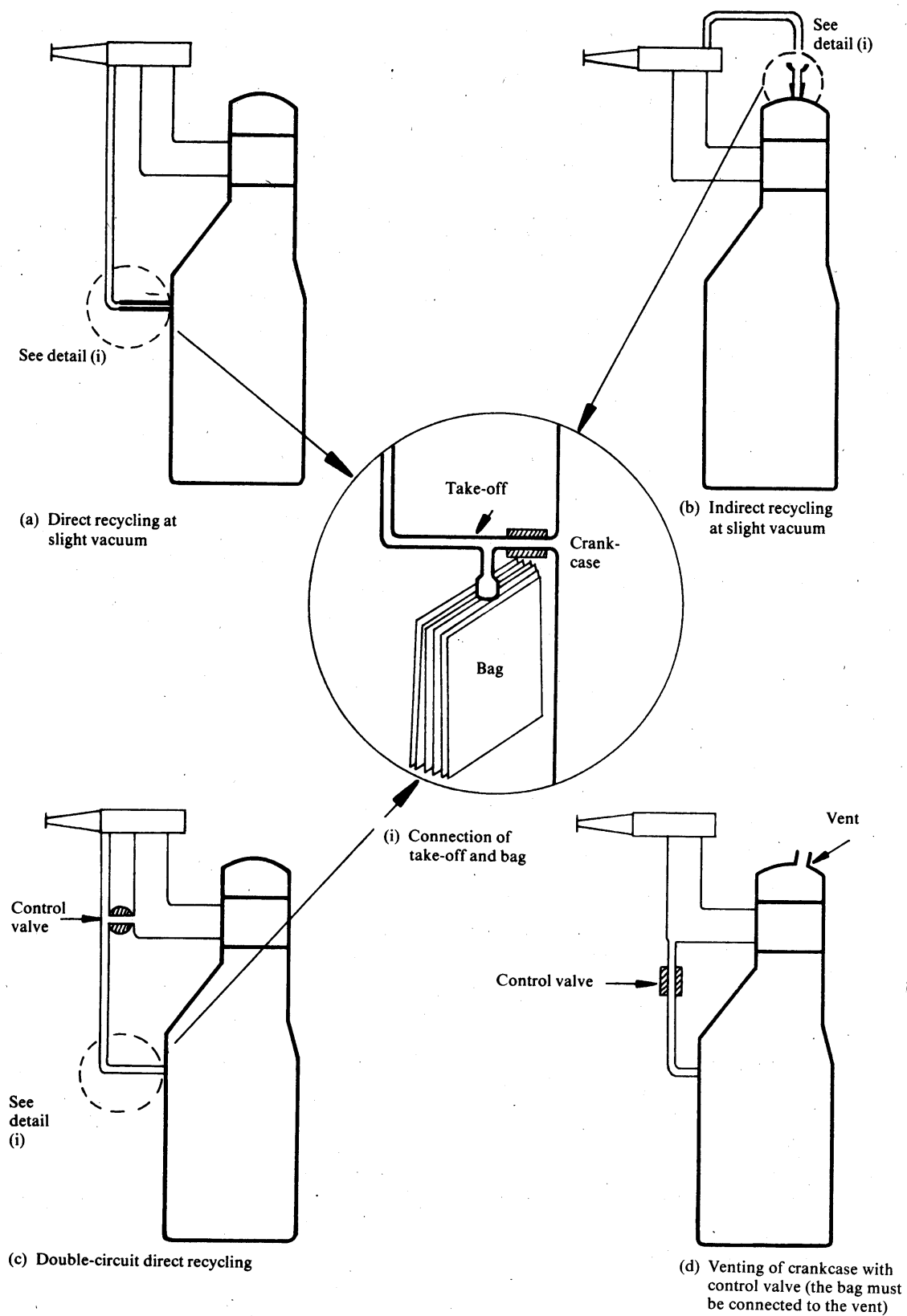

## ANNEX VI

## TYPE IV TEST

## THE DETERMINATION OF EVAPORATIVE EMISSIONS FROM VEHICLES WITH SPARK-IGNITION ENGINES

## 1. INTRODUCTION

This Annex describes the procedure of the type IV test according to section 5.3.4 of Annex I.

This procedure describes a method for the determination of the loss of hydrocarbons by evaporation from the fuel systems of vehicles with spark ignition engines.

## 2. DESCRIPTION OF TEST

The evaporative emission test (Figure VI.2) consists of four phases:

- test preparation,
- tank breathing loss determination,
- urban (Part One) and extra-urban (Part Two) driving cycle,
- hot soak loss determination.

Mass emissions of hydrocarbons from the tank breathing loss and the hot soak loss phases are summed to provide an overall result for the test.

## 3. VEHICLE AND FUEL

3.1. **Vehicle**

- 3.1.1. The vehicle must be in good mechanical condition and have been run in and driven at least 3 000 km before the test. The evaporative emission control system must be connected and functioning correctly over this period and the carbon canister subjected to normal use, neither undergoing abnormal purging nor abnormal loading.

3.2. **Fuel**

- 3.2.1. The appropriate reference fuel must be used, as defined in Annex VIII to this Directive.

## 4. TEST EQUIPMENT

4.1. **Chassis dynamometer**

The chassis dynamometer must meet the requirements of Annex III.

4.2. **Evaporative emission measurement enclosure**

- 4.2.1. The evaporative emission measurement enclosure must be a gas-tight rectangular measuring chamber able to contain the vehicle under test. The vehicle must be accessible from all sides and the enclosure when sealed must be gas tight in accordance with Appendix 1. The inner surface of the enclosure must be impermeable to hydrocarbons. At least one of the surfaces must incorporate a flexible impermeable material to allow the equilibration of pressure changes resulting from small changes in temperature. Wall design must be such as to promote good dissipation of heat. The temperature of the wall must not drop below 293 K (20 °C) at any point during testing.

▼M9

Figure VI.2

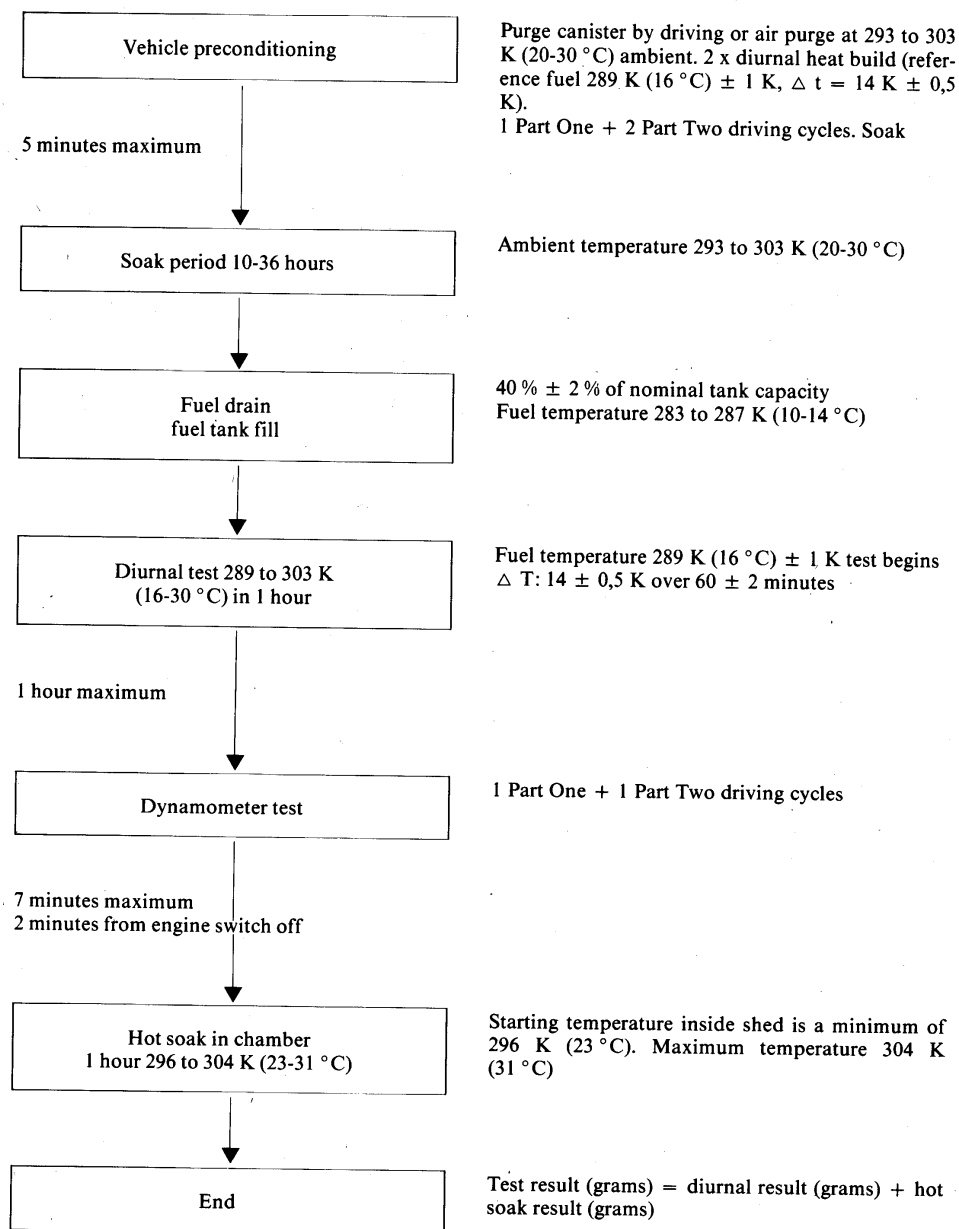
**Evaporative emission determination***3 000 km run-in period (no excessive purge/load) Steam clean of vehicle (if necessary)*

Note:

1. Evaporative emission control families — details clarified.
2. Tailpipe emissions may be measured during dynamometer test, but these are not used for legislative purposes. Exhaust emission legislative test remains separate.

▼ **M9****4.3. Analytical systems****4.3.1. Hydrocarbon analyzer**

4.3.1.1. The atmosphere within the chamber is monitored using a hydrocarbon detector of the flame ionization detector (FID) type. Sample gas must be drawn from the midpoint of one side wall or roof of the chamber and any bypass flow must be returned to the enclosure, preferably to a point immediately downstream of the mixing fan.

4.3.1.2. The hydrocarbon analyzer must have a response time to 90 % of final reading of less than 1,5 seconds. Its stability shall be better than 2 % of full scale at zero and at  $80 \pm 20$  % of full scale over a 15-minute period for all operational ranges.

4.3.1.3. The repeatability of the analyzer expressed as one standard deviation shall be better than 1 % of full scale deflection at zero and at  $80 \pm 20$  % of full scale on all ranges used.

4.3.1.4. The operational ranges of the analyzer must be chosen to give best resolution over the measurement, calibration and leak checking procedures.

**4.3.2. Hydrocarbon analyzer data recording system**

4.3.2.1. The hydrocarbon analyzer must be fitted with a device to record electrical signal output either by strip chart recorder or other data-processing system at a frequency of at least once per minute. The recording system must have operating characteristics at least equivalent to the signal being recorded and must provide a permanent record of results. The record shall show a positive indication of the beginning and end of the fuel tank heating and hot soak periods together with the time elapsed between start and completion of each test.

**4.4. Fuel tank heating**

4.4.1. The fuel in the vehicle tank(s) must be heated by a controllable source of heat, for example a heating pad of 2 000 W capacity is suitable. The heating system must apply heat evenly to the tank walls beneath the level of the fuel so as not to cause local overheating of the fuel. Heat must not be applied to the vapour in the tank above the fuel.

4.4.2. The tank heating device must make it possible to evenly heat the fuel in the tank by 14 K from 289 K (16 °C) within 60 minutes, with the temperature sensor position as in section 5.1.1. The heating system must be capable of controlling the fuel temperature to  $\pm 1,5$  K of the required temperature during the tank heating process.

**4.5. Temperature recording**

4.5.1. The temperature in the chamber is recorded at two points by temperature sensors which are connected so as to show a mean value. The measuring points are extended approximately 0,1 m into the enclosure from the vertical centre line of each side wall at a height of  $0,9 \pm 0,2$  m.

4.5.2. The temperatures of the fuel tank(s) shall be recorded by means of the sensor positioned in the fuel tank as in 5.1.1.

4.5.3. Temperatures must, throughout the evaporative emission measurements, be recorded or entered into a data processing system at a frequency of at least once per minute.

4.5.4. The accuracy of the temperature recording system must be within  $\pm 1,0$  K and the temperature must be capable of being resolved to 0,4 K.

4.5.5. The recording or data processing system must be capable of resolving time to  $\pm 15$  seconds.

**4.6. Fans**

4.6.1. By the use of one or more fans or blowers with the SHED door(s) open it must be possible to reduce the hydrocarbons concentration in the chamber to the ambient hydrocarbon level.

▼ **M9**

- 4.6.2. The chamber must have one or more fans or blowers of likely capacity  $0,1$  to  $0,5 \text{ m}^3\text{s}^{-1}$  with which to thoroughly mix the atmosphere in the enclosure. It must be possible to attain an even temperature and hydrocarbon concentration in the chamber during measurements. The vehicle in the enclosure must not be subjected to a direct stream of air from the fans or blowers.
- 4.7. **Gases**
- 4.7.1. The following pure gases must be available for calibration and operation:
- purified synthetic air (purity:  $< 1 \text{ ppm C}_1$  equivalent  $\leq 1 \text{ ppm CO}$ ,  $\leq 400 \text{ ppm CO}_2$ ,  $\leq 0,1 \text{ ppm NO}$ ); oxygen content between 18 and 21 % by volume,
  - hydrocarbon analyzer fuel gas ( $40 \pm 2 \%$  hydrogen, and balance helium with less than  $1 \text{ ppm C1}$  equivalent hydrocarbon, less than  $400 \text{ ppm CO}_2$ ),
  - propane ( $\text{C}_3\text{H}_8$ ), 99,5 % minimum purity.
- 4.7.2. Calibration and span gases shall be available containing mixtures of propane ( $\text{C}_3\text{H}_8$ ) and purified synthetic air. The true concentrations of a calibration gas must be within  $\pm 2 \%$  of the stated figures. The accuracy of the diluted gases obtained when using a gas divider must be to within  $\pm 2 \%$  of the true value. The concentrations specified in Appendix 1 may also be obtained by the use of a gas divider using synthetic air as the diluent gas.
- 4.8. **Additional equipment**
- 4.8.1. The absolute humidity in the test area must be measurable to within  $\pm 5 \%$ .
- 4.8.2. The pressure within the test area must be measurable to within  $\pm 0,1 \text{ kPa}$ .
5. TEST PROCEDURE
- 5.1. **Test preparation**
- 5.1.1. The vehicle is mechanically prepared before the test as follows:
- the exhaust system of the vehicle must not exhibit any leaks,
  - the vehicle may be steam cleaned before the test,
  - the fuel tank of the vehicle must be equipped with a temperature sensor to enable the temperature to be measured at the midpoint of the fuel in the fuel tank when filled to 40 % of its capacity,
  - additional fittings, adaptors or devices must be fitted to allow a complete draining of the fuel tank.
- 5.1.2. The vehicle is taken into the test area where the ambient temperature is between 293 and 303 K ( $20^\circ$  and  $30^\circ \text{C}$ ).
- 5.1.3. The canister of the vehicle is purged for 30 minutes by driving the car at 60 km/h at the dynamometer setting prescribed in Annex III — Appendix 2 or by passing air (at room temperature and humidity) through the canister at a flow rate which is identical to the actual air flow through the canister when operating the car at 60 km/h. The canister is subsequently loaded with two diurnal emissions tests.
- 5.1.4. The fuel tank(s) of the vehicle is(are) emptied using the fuel tank drain(s) provided. This must be done so as not to abnormally purge nor abnormally load the evaporative control devices fitted to the vehicle. Removal of the fuel cap(s) will normally be sufficient to achieve this.
- 5.1.5. ► **M12** The fuel tank(s) is (are) refilled with the specified test fuel at a temperature below 287 K ( $14^\circ \text{C}$ ) to  $40 \pm 2 \%$  of its/their normal fuel capacity. ◀ The vehicle's fuel cap(s) must not be replaced at this point.
- 5.1.6. In the case of vehicles fitted with more than one fuel tank, all the tanks must be heated in the same way, as described below. The temperatures of the tanks must be identical to within  $\pm 1,5 \text{ K}$ .
- 5.1.7. The fuel may be artificially heated to the starting temperature of 289 K ( $16^\circ \text{C}$ )  $\pm 1 \text{ K}$ .

▼ **M9**

- 5.1.8. As soon as the fuel reaches a temperature of 287 K (14 °C), the fuel tank(s) must be sealed. When the temperature of the fuel tank reaches 289 K (16 °C)  $\pm$  1 K a linear heat build of 14  $\pm$  0,5 K over a period of 60  $\pm$  2 minutes begins. The temperature of the fuel during the heating shall conform to the function below to within  $\pm$  1,5 K:

$$T_r = T_o + 0,2333.t$$

where:

$T_r$  = required temperature (K),

$T_o$  = initial temperature of tank (K),

t = time from start of the tank heat build in minutes.

The elapsed time of the heat build and temperature rise is recorded.

- 5.1.9. After a period of not more than one hour, the operations of fuel draining and filling begin according to 5.1.4, 5.1.5, 5.1.6 and 5.1.7.
- 5.1.10. Within two hours of the end of the first tank heating period the second fuel tank heating operation begins as specified in 5.1.8 and must be completed with the recording of the temperature rise and elapsed time of the heat build.
- 5.1.11. Within one hour of the end of the second tank heat build the vehicle is placed on a chassis dynamometer and is driven through one Part One and two Part Two driving cycles. Exhaust emissions are not sampled during this operation.
- 5.1.12. Within five minutes of completing the preconditioning operation specified in 5.1.11 the engine bonnet must be completely closed and the vehicle driven off the chassis dynamometer and parked in the soak area. The vehicle is parked for a minimum of 10 hours and a maximum of 36 hours. The engine oil and coolant temperatures must have reached the temperature of the area of within  $\pm$  2 K at the end of the period.

5.2. **Tank breathing evaporative emission test**

- 5.2.1. The operation of 5.2.4 may begin not less than nine hours nor more than 35 hours after the preconditioning driving cycle.
- 5.2.2. The measuring chamber shall be purged for several minutes immediately before the test until a stable background is obtainable. The chamber mixing fan(s) must be switched on at this time also.
- 5.2.3. The hydrocarbon analyzer must be zeroed and spanned immediately before the test.
- 5.2.4. The fuel tank(s) must be emptied as in 5.1.4 and refilled with test fuel at a temperature of between 283 and 287 K (10 ° and 14 °C) to 40  $\pm$  2 % of the tank's normal volumetric capacity. The fuel cap(s) of the vehicle must not be fitted at this point.
- 5.2.5. In the case of vehicles fitted with more than one fuel tank, all the tanks shall be heated in the same way, as described below. The temperatures of the tanks must be identical to within  $\pm$  1,5 K.
- 5.2.6. The test vehicle shall be brought into the test enclosure with the engine switched off and the windows and luggage compartment open. The fuel tank sensors and the fuel tank heating device, if necessary, shall be connected. Immediately begin recording the fuel temperature and the air temperature within the enclosure. The purging fan if still operating is switched off at this time.
- 5.2.7. The fuel may be artificially heated to the starting temperature of 289 K (16 °C)  $\pm$  1 K.
- 5.2.8. As soon as the fuel temperature reaches 287 K (14 °C), the fuel tank(s) must be sealed, and the chamber sealed so that it is gas-tight.
- 5.2.9. As soon as the fuel reaches a temperature of 289 K (16 °)  $\pm$  1 K:  
 — the hydrocarbon concentration, barometric pressure and the temperature are measured to give the initial readings  $C_{HC, i}$ ,  $P_i$  and  $T_i$  for the tank heat build test,



▼ **M9**

- a linear heat build of  $14 \pm 0,5$  K over a period of  $60 \pm 2$  minutes shall begin. The temperature of the fuel during the heating shall conform to the function below to within  $\pm 1,5$  K:

$$T_r = T_o + 0,2333 \cdot t$$

where:

$T_r$  = required temperature (K),

$T_o$  = initial temperature of tank (K),

$t$  = time from start of the tank heat build in minutes.

- 5.2.10. The hydrocarbon analyzer is zeroed and spanned immediately before the end of the test.
- 5.2.11. If the temperature has risen by  $14 \text{ K} \pm 0,5 \text{ K}$  over the  $60 \pm 2$  minutes period of the test the final hydrocarbon concentration in the enclosure is measured ( $C_{\text{HC,P}}$ ). The time or elapsed time of this together with the final temperature and barometric pressure  $T_f$  and  $P_f$  for the hot soak is recorded.
- 5.2.12. The heat source is turned off and the enclosure door unsealed and opened. The heating device and temperature sensor are disconnected from the enclosure apparatus. The vehicle doors and luggage compartment may now be closed and the vehicle removed from the enclosure with the engine switched off.
- 5.2.13. The vehicle is prepared for the subsequent driving cycles and hot soak evaporative emission test. The cold start test must follow the tank breathing test by a period of not more than one hour.
- 5.2.14. The regulatory authority may consider that the design of the vehicle's fuel system may allow losses to the outside atmosphere at any point. In this case an engineering analysis must be carried out to the satisfaction of the regulatory authority to establish that vapours are vented to the carbon canister and that these vapours are adequately purged during vehicle operation.
- 5.3. **Driving cycle**
- 5.3.1. The determination for evaporative emissions is concluded with the measurement of hydrocarbon emissions over a 60-minute hot soak period following an urban and extra-urban driving cycle. Following the tank breathing losses test, the vehicle is pushed or otherwise manoeuvred onto the chassis dynamometer with the engine switched off. It is then driven through a cold start urban and extra-urban test as described in Annex III. Exhaust emissions may be sampled during this operation but the results are not used for the purpose of exhaust emission type approval.
- 5.4. **Hot soak evaporative emissions test**
- 5.4.1. Before the completion of the test run the measuring chamber must be purged for several minutes until a stable hydrocarbon background is obtained. The enclosure mixing fan(s) must also be turned on at this time.
- 5.4.2. The hydrocarbon analyzer must be zeroed and spanned immediately prior to the test.
- 5.4.3. At the end of the driving cycle the engine bonnet must be completely closed and all connections between the vehicle and the test stand disconnected. The vehicle is then driven to the measuring chamber with a minimum use of the accelerator pedal. The engine must be turned off before any part of the vehicle enters the measuring chamber. The time at which the engine is switched off is recorded on the evaporative emission measurement data recording system and temperature recording begins. The vehicle's windows and luggage compartments must be opened at this stage, if not already opened.
- 5.4.4. The vehicle must be pushed or otherwise moved into the measuring chamber with the engine switched off.
- 5.4.5. The enclosure doors are closed and sealed gas-tight within two minutes of the engine being switched off and within seven minutes of the end of the driving cycle.
- 5.4.6. The start of a  $60 \pm 0,5$  minute hot soak period begins when the chamber is sealed. The hydrocarbon concentration, temperature

▼ **M9**

and barometric pressure are measured to give the initial readings  $C_{HC,i}$ ,  $P_i$  and  $T_i$  for the hot soak test. These figures are used in the evaporative emission calculation, section 6. The ambient SHED temperature  $T$  must not be less than 296 K and no more than 304 K during the 60-minute hot soak period.

- 5.4.7. The hydrocarbon analyzer must be zeroed and spanned immediately before the end of the  $60 \pm 0,5$  minute test period.
- 5.4.8. At the end of the  $60 \pm 0,5$  minute test period measure the hydrocarbon concentration in the chamber. The temperature and the barometric pressure are also measured. These are the final readings  $C_{HC,f}$ ,  $P_f$  and  $T_f$  for the hot soak test used for the calculation in section 6. This completes the evaporative emission test procedure.

## 6. CALCULATION

The evaporative emission tests described in section 5 allow the hydrocarbon emissions from the tank breathing and hot soak phases to be calculated. Evaporative losses from each of these phases is calculated using the initial and final hydrocarbon concentrations, temperatures and pressures in the enclosure, together with the net enclosure volume.

The formula below is used:

$$M_{HC} = k.V. 10^{-4} \cdot \left( \frac{C_{HC,f} \cdot P_f}{T_f} - \frac{C_{HC,i} \cdot P_i}{T_i} \right)$$

where:

- $M_{HC}$  = mass of hydrocarbon emitted over the test phase (grams),
- $C_{HC}$  = measured hydrocarbon concentration in the enclosure (ppm (volume)  $C_i$  equivalent),
- $V$  = net enclosure volume in cubic metres corrected for the volume of the vehicle, with the windows and the luggage compartment open. If the volume of the vehicle is not determined a volume of 1,42 m<sup>3</sup> is subtracted,
- $T$  = ambient chamber temperature, K,
- $P$  = barometric pressure in kPA,
- $H/C$  = hydrogen to carbon ratio,
- $k$  = 1,2 (12 + H/C);

when:

$i$  is the initial reading,

$f$  is the final reading,

$H/C$  is taken to be 2,33 for tank breathing losses,

$H/C$  is taken to be 2,20 for hot soak losses.

## 6.2. Overall results of test

The overall hydrocarbon mass emission for the vehicle is taken to be:

$$M_{total} = M_{TH} + M_{HS}$$

where:

- $M_{total}$  = overall mass emissions of the vehicle (grams),
- $M_{TH}$  = hydrocarbon mass emission for the tank heat build (grams),
- $M_{HS}$  = hydrocarbon mass emission for the hot soak (grams).

## 7. CONFORMITY OF PRODUCTION

- 7.1. For routine end-of-production-line testing, the holder of the approval may demonstrate compliance by sampling vehicles which shall meet the following requirements.

**▼ M9****7.2. Test for leakage**

- 7.2.1. Vents to the atmosphere from the emission control system shall be isolated.
- 7.2.2. A pressure of  $370 \pm 10$  mm of H<sub>2</sub>O must be applied to the fuel system.
- 7.2.3. The pressure must be allowed to stabilize prior to isolating the fuel system from the pressure source.
- 7.2.4. Following isolation of the fuel system, the pressure must not drop by more than 50 mm of H<sub>2</sub>O in five minutes.

**7.3. Test for venting**

- 7.3.1. Vents to the atmosphere from the emission control must be isolated.
- 7.3.2. A pressure of  $370 \pm 10$  mm of H<sub>2</sub>O must be applied to the fuel system.
- 7.3.3. The pressure must be allowed to stabilize prior to isolating the fuel system from the pressure source.
- 7.3.4. The venting outlets from the emission control systems to the atmosphere must be reinstated to the production condition.
- 7.3.5. The pressure of the fuel system must drop to below 100 mm of H<sub>2</sub>O in not less than 30 seconds but within two minutes.

**▼ M12**

- 7.3.6. At the request of the manufacturer the functional capacity for venting can be demonstrated by equivalent alternative procedure. The specific procedure should be demonstrated by the manufacturer to the technical service during the type approval procedure.

**▼ M9****7.4. Purge test**

- 7.4.1. Equipment capable of detecting an airflow rate of 1,0 litres in one minute must be attached to the purge inlet and a pressure vessel of sufficient size to have negligible effect on the purge system must be connected via a switching valve to the purge inlet, or alternatively,
  - 7.4.2. the manufacturer may use a flow meter of his own choice, if acceptable to the competent authority.
- 7.4.3. The vehicle must be operated in such a manner that any design feature of the purge system that could restrict purge operation is detected and the circumstances noted.
- 7.4.4. Whilst the engine is operating within the bounds noted in 7.4.3, the air flow must be determined by either:
  - 7.4.4.1. the device indicated in 7.4.1 being switched in. A pressure drop from atmospheric to a level indicating that a volume of 1,0 litres of air has flowed into the evaporative emission control system within one minute must be observed; or
  - 7.4.4.2. if an alternative flow measuring device is used, a reading of no less than 1,0 litre per minute must be detectable.

**▼ M12**

- 7.4.4.3. At the request of the manufacturer an alternative purge test procedure can be used, if the procedure has been presented to and has been accepted by the technical service during the type approval procedure.

**▼ M9**

- 7.5. The competent authority which has granted type-approval may at any time verify the conformity control methods applicable to each production unit.
  - 7.5.1. The inspector must take a sufficiently large sample from the series.
  - 7.5.2. The inspector may test these vehicles by application of either 7.1.4 or 7.1.5 of Annex I.
  - 7.5.3. If in pursuance of section 7.1.5 of Annex I the vehicle's test result falls outside the agreed limits of section 5.3.4.2 of Annex I, the

**▼M9**

- manufacturer may request that the approval procedure referred to in 7.1.4 of Annex I be applied.
- 7.5.3.1. The manufacturer must not be allowed to adjust, repair or modify any of the vehicles, unless they failed to comply with the requirements of section 7.1.4 of Annex I and unless such work is documented in the manufacturer's vehicle assembly and inspection procedures.
- 7.5.3.2. The manufacturer may request a single re-test for a vehicle whose evaporative emission characteristics are likely to have changed due to his actions under 7.5.3.1.
- 7.6. If the requirements of 7.5 are not met, the competent authority must ensure that all necessary steps are taken to re-establish conformity of production as rapidly as possible.

▼ **M9***Appendix 1***CALIBRATION OF EQUIPMENT FOR EVAPORATIVE EMISSION TESTING**

1. CALIBRATION FREQUENCY AND METHODS
  - 1.1. All equipment must be calibrated before its initial use and then calibrated as often as necessary and in any case in the month before type-approval testing. The calibration methods to be used are described in this Appendix.
2. CALIBRATION OF THE ENCLOSURE
  - 2.1. **Initial determination of enclosure internal volume**
    - 2.1.1. Before its initial use, the internal volume of the chamber must be determined as follows. The internal dimensions of the chamber are carefully measured, allowing for any irregularities such as bracing struts. The internal volume of the chamber is determined from these measurements.
    - 2.1.2. The net internal volume is determined by subtracting 1,42 m<sup>3</sup> from the internal volume of the chamber. Alternatively the volume of the test vehicle with the luggage compartment and windows open may be used instead of the 1,42 m<sup>3</sup>.
    - 2.1.3. The chamber must be checked as in item 2.3. If the propane mass does not agree with the injected mass to within  $\pm 2\%$  then corrective action is required.
  - 2.2. **Determination of chamber background emissions**

This operation determines that the chamber does not contain any materials that emit significant amounts of hydrocarbons. The check must be carried out at the enclosure's introduction to service, after any operations in the enclosure which may affect background emissions and at a frequency of at least once per year.

    - 2.2.1. Calibrate the analyzer (if required), then zero and span.
    - 2.2.2. Purge the enclosure until a stable hydrocarbon reading is obtained. The mixing fan is turned on if not already on.
    - 2.2.3. Seal the chamber and measure the background hydrocarbon concentration, temperature and barometric pressure. These are the initial readings  $C_{HC,P}$ ,  $P_i$  and  $T_i$  used in the enclosure background calculation.
    - 2.2.4. The enclosure is allowed to stand undisturbed with the mixing fan on for a period of four hours.
    - 2.2.5. At the end of this time use the same analyzer to measure the hydrocarbon concentration in the chamber. The temperature and the barometric pressure are also measured. These are the final readings  $C_{HC,P}$ ,  $P_f$  and  $T_f$ .
    - 2.2.6. Calculate the change in mass of hydrocarbons in the enclosure over the time of the test according to section 2.4. The background emission of the enclosure must not exceed 0,4 g.
  - 2.3. **Calibration and hydrocarbon retention test of the chamber**

The calibration and hydrocarbon retention test in the chamber provides a check on the calculated volume in 2.1 and also measures any leak rate.

    - 2.3.1. Purge the enclosure until a stable hydrocarbon concentration is reached. Turn on the mixing fan, if not already switched on. The hydrocarbon analyzer is zeroed, calibrated if required, and spanned.
    - 2.3.2. Seal the enclosure and measure the background concentration, temperature and barometric pressure. These are the initial readings  $C_{HC,P}$ ,  $P_i$  and  $T_i$  used in the enclosure calibration.

**▼ M9**

- 2.3.3. Inject a quantity of approximately 4 grams of propane into the enclosure. The mass of propane must be measured to an accuracy and precision of  $\pm 0,5$  % of the measured value.
- 2.3.4. Allow the contents of the chamber to mix for five minutes and then measure the hydrocarbon concentration, temperature and barometric pressure. These are the final readings  $C_{HC,f}$ ,  $T_f$  and  $P_f$  for the calibration of the enclosure.
- 2.3.5. Using the readings taken in 2.3.2 and 2.3.4 and the formula in 2.4, calculate the mass of propane in the enclosure. This must be within  $\pm 2$  % of the mass of propane measured in 2.3.3.
- 2.3.6. Allow the contents of the chamber to mix for a minimum of four hours. At the end of this period measure and record the final hydrocarbon concentration, temperature and barometric pressure.
- 2.3.7. Calculate using the formula in 2.4, the hydrocarbon mass from the readings taken in 2.3.6 and 2.3.2. The mass may not differ by more than 4 % from the hydrocarbon mass given by 2.3.5.

**2.4. Calculations**

The calculation of net hydrocarbon mass change within the enclosure is used to determine the chamber's hydrocarbon background and leak rate. Initial and final readings of hydrocarbon concentration, temperature and barometric pressure are used in the following formula to calculate the mass change.

$$M_{HC} = k \cdot V \cdot 10^{-4} \cdot \left( \frac{C_{HC,f} \cdot P_f}{T_f} - \frac{C_{HC,i} \cdot P_i}{T_i} \right)$$

where:

- $M_{HC}$  = hydrocarbon mass in grams,  
 $C_{HC}$  = hydrocarbon concentration in the enclosure (ppm carbon (NB: ppm carbon = ppm propane  $\times$  3)),  
 $V$  = enclosure volume in cubic metres,  
 $T$  = ambient temperature in the enclosure, K,  
 $P$  = barometric pressure, kPa,  
 $k$  = 17,6;

when:

- $i$  is the initial reading,  
 $f$  is the final reading.

**3. CHECKING OF FID HYDROCARBON ANALYZER****3.1. Detector response optimization**

The FID must be adjusted as specified by the instrument manufacturer. Propane in air should be used to optimize the response on the most common operating range.

**3.2. Calibration of the HC analyzer**

The analyzer should be calibrated using propane in air and purified synthetic air. See section 4.5.2 of Annex III (Calibration and span gases).

Establish a calibration curve as described in sections 4.1 to 4.5 of this Appendix.

**3.3. Oxygen interference check and recommended limits**

The response factor (Rf) for a particular hydrocarbon species is the ratio of the FID  $C_1$  reading to the gas cylinder concentration, expressed as ppm  $C_1$ .

The concentration of the test gas must be at a level to give a response of approximately 80 % of full scale deflection, for the operating range. The concentration must be known, to an accuracy of  $\pm 2$  % in reference to a gravimetric standard expressed in volume. In addition the gas cylinder must be preconditioned

▼ M9

for 24 hours at a temperature between 293 K and 303 K (20 ° and 30 °C).

Response factors should be determined when introducing an analyzer into service and thereafter at major service intervals. The reference gas to be used is propane with balance purified air which is taken to give a response factor of 1,00.

The test gas to be used for oxygen interference and the recommended response factor range are given below:

Propane and nitrogen  $0,95 \leq R_f \leq 1,05$ .

#### 4. CALIBRATION OF THE HYDROCARBON ANALYZER

Each of the normally used operating ranges are calibrated by the following procedure:

- 4.1. Establish the calibration curve by at least five calibration points spaced as evenly as possible over the operating range. The nominal concentration of the calibration gas with the highest concentrations to be at least 80 % of the full scale.
- 4.2. Calculate the calibration curve by the method of least squares. If the resulting polynomial degree is greater than 3, then the number of calibration points must be at least the number of the polynomial degree plus 2.
- 4.3. The calibration curve must not differ by more than 2 % from the nominal value of each calibration gas.
- 4.4. Using the coefficients of the polynomial derived from 3.2, a table of indicated reading against true concentration shall be drawn up in steps of no greater than 1 % of full scale. This is to be carried out for each analyzer range calibrated. The table shall also contain other relevant data such as:
  - date of calibration,
  - span and zero potentiometer readings (where applicable),
  - nominal scale,
  - reference data of each calibration gas used,
  - the actual and indicated value of each calibration gas used together with the percentage differences,
  - FID fuel and type,
  - FID air pressure.
- 4.5. If it can be shown to the satisfaction of the Regulatory Agency that alternative technology (e.g. computer, electronically controlled range switch) can give equivalent accuracy, then those alternatives may be used.

▼ **M9***ANNEX VII*

Description of the ageing test for verifying the durability of anti-pollution devices

## 1. INTRODUCTION

This Annex described the test for verifying the durability of anti-pollution devices equipping vehicles with positive-ignition or compression-ignition engines during an ageing test of 80 000 km.

## 2. TEST VEHICLE

## 2.1. The vehicle must be in good mechanical order; the engine and the anti-pollution devices must be new.

The vehicle may be the same as that presented for the type I test; this type I test has to be done after the vehicle has run at least 3 000 km of the ageing cycle of section 5.1.

## 3. FUEL

The durability test is conducted with commercially available unleaded petrol or diesel fuel.

## 4. VEHICLE MAINTENANCE AND ADJUSTMENTS

Maintenance, adjustments as well as the use of the test vehicle's controls shall be those recommended by the manufacturer.

## 5. VEHICLE OPERATION ON TRACK, ROAD OR ON CHASSIS DYNAMOMETER

5.1. **Operating cycle**

During operation on track, road or on roller test bench, the distance must be covered according to the driving schedule (Figure VII.5.1) described below:

- the durability test schedule is composed of 11 cycles covering 6 kilometres each,
- during the first nine cycles, the vehicle is stopped four times in the middle of the cycle, with the engine idling each time for 15 seconds,
- normal acceleration and deceleration,
- five decelerations in the middle of each cycle, dropping from cycle speed to 32 km/h, and the vehicle is gradually accelerated again until cycle speed is attained,
- the 10th cycle is carried out at a steady speed of 89 km/h,
- the 11th cycle begins with maximum acceleration from stop point up to 113 km/h. At half-way, braking is employed normally until the vehicle comes to a stop. This is followed by an idle period of 15 seconds and a second maximum acceleration.

The schedule is then restarted from the beginning. The maximum speed of each cycle is given in the following Table.

*Table VII.5.1.*

**Maximum speed of each cycle**

Cycle	Cycle speed in km/h
1	64
2	48
3	64
4	64
5	56
6	48
7	56
8	72



**▼M9**

Cycle	Cycle speed in km/h
9	56
10	89
11	113

▼ M9

Figure VII.5.1  
Driving schedule

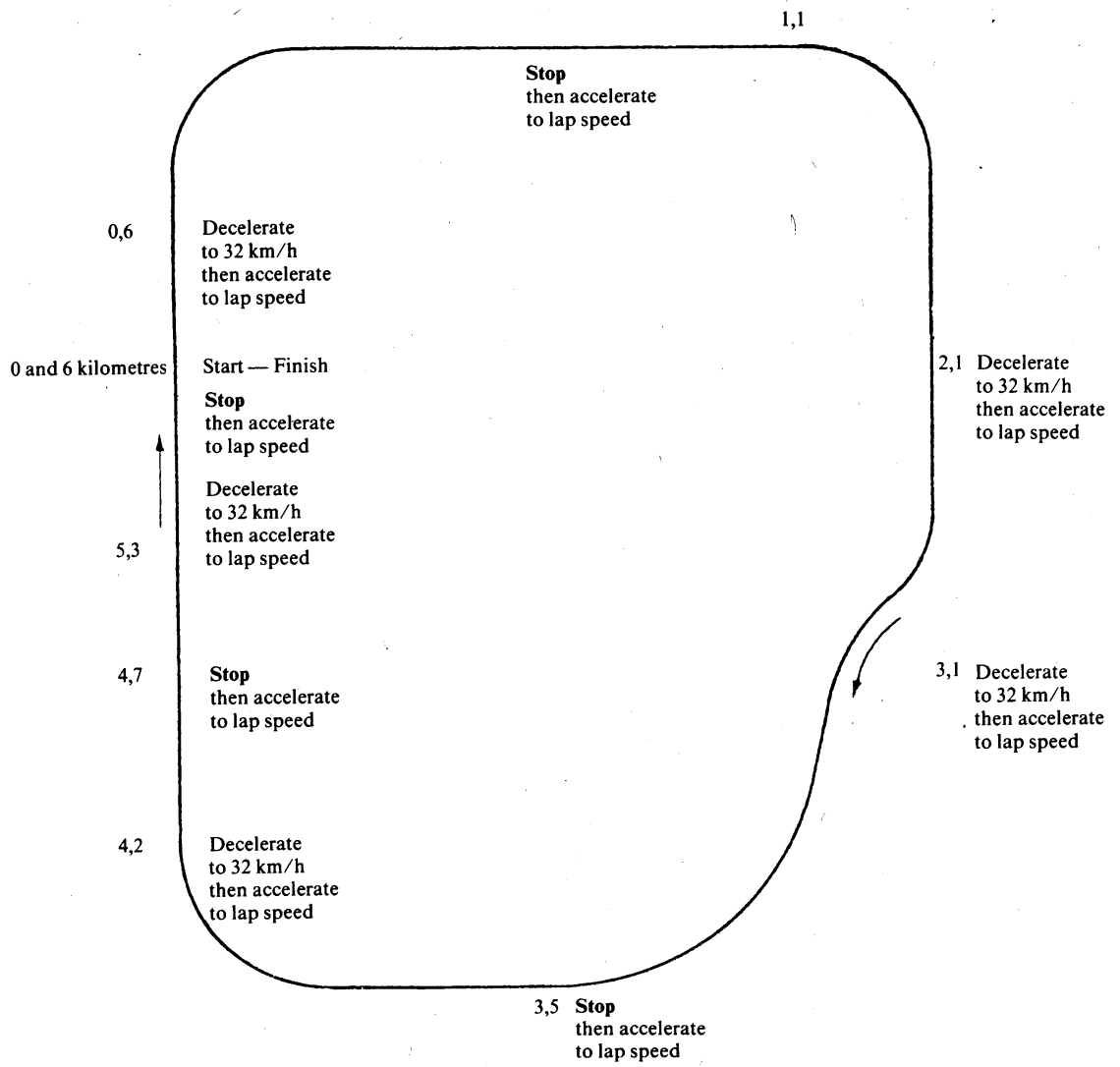

▼ **M9**

- 5.1.1. At the request of the manufacturer, an alternative road test schedule may be used. Such alternative test schedules shall be approved by the technical service in advance of the test and must have substantially the same average speed, distribution of speeds, number of stops per kilometres and number of accelerations per kilometres as the driving schedule used on track or roller test bench, as detailed in 5.1 and Figure VII.5.1.
- 5.1.2. The durability test, or if the manufacturer has chosen, the modified durability test shall be conducted until the vehicle has covered a minimum of 80 000 km.

5.2. **Test equipment**5.2.1. *Chassis dynamometer*

- 5.2.1.1. When the durability test is performed on a chassis dynamometer, the dynamometer must enable the cycle described in 5.1 to be carried out. In particular, it must be equipped with systems simulating inertia and resistance to progress.
- 5.2.1.2. The brake must be adjusted in order to absorb the power exerted on the driving wheels at a steady speed of 80 km/h. Methods to be applied to determine this power and to adjust the brake are the same as those described in Appendix 3 to Annex III.
- 5.2.1.3. The vehicle cooling system should enable the vehicle to operate at temperatures similar to those obtained on road (oil, water, exhaust system, etc.).
- 5.2.1.4. Certain other test bench adjustments and features are deemed to be identical, where necessary, to those described in Annex III of this Directive (inertia, for example, which may be mechanical or electronic).
- 5.2.1.5. The vehicle may be moved, where necessary, to a different bench in order to conduct emission measurement tests.

5.2.2. *Operation on track or road*

When the durability test is completed on track or road, the vehicle's reference mass will be at least equal to that retained for tests conducted on a chassis dynamometer.

## 6. MEASURING EMISSIONS OF POLLUTANTS

At the start of the test (0 km), and every 10 000 km ( $\pm$  400 km) or more frequently, at regular intervals until having covered 80 000 km, tailpipe emissions are measured in accordance with the type I test as defined in Annex I, section 5.3.1. The limit values to be complied with are those laid down in section 5.3.1.4 of Annex I. However, the tailpipe emissions may also be measured in accordance with the provisions of Annex I, section 8.2.

All exhaust emissions results must be plotted as a function of the running distance on the system rounded to the nearest kilometre and the best fit straight line fitted by the method of least squares shall be drawn through all these data points. This calculation shall not take into account the test results at 0 km.

The data will be acceptable for use in the calculation of the deterioration factor only if the interpolated 6 400 km and 80 000 km points on this line are within the above mentioned limits. The data are still acceptable when a best fit straight line crosses an applicable limit with a negative slope (the 6 400 km interpolated point is higher than the 80 000 km interpolated point) but the 80 000 km actual data point is below the limit.

A multiplicative exhaust emission deterioration factor shall be calculated for each pollutant as follows:

$$\text{D.E.F.} = \frac{M_{i2}}{M_{i1}}$$

where:

$M_{i1}$  = mass emission of the pollutant  $i$  in grams per km interpolated to 6 400 km,

**▼ M9**

$Mi_2$  = mass emission of the pollutant  $i$  in grams per km interpolated to 80 000 km.

These interpolated values must be carried out to a minimum of four places to the right of the decimal point before dividing one by the other to determine the deterioration factor. The result must be rounded to three places to the right of the decimal point.

If a deterioration factor is less than one, it is deemed to be equal to one.

▼M9

## ANNEX VIII

## SPECIFICATIONS AND REFERENCE FUELS

## 1. TECHNICAL DATA OF THE REFERENCE FUEL TO BE USED FOR TESTING VEHICLES EQUIPPED WITH POSITIVE-IGNITION ENGINES

CEC-reference fuel RF-08-A-85

Type: premium petrol, unleaded (1)

	Limits and Unit (2)		ASTM method (3)
	minimum	maximum	
Research octane number	95,0		D 2699
Motor octane number	85,0		D 2700
Density at 15 °C	0,748	0,762	D 1298
Reid vapour pressure	0,56 bar	0,64 bar	D 323
Distillation: (4)			
— initial boiling point	24 °C	40 °C	D 86
— 10 % vol point	42 °C	58 °C	
— 50 % vol point	90 °C	110 °C	
— 90 % vol point	155 °C	180 °C	
— final boiling point	190 °C	215 °C	
Residue		2 %	D 86
Hydrocarbon analysis:			
— olefins		20 % vol	D 1319
— aromatics	(Including max. 5 % vol benzene (*)	45 % vol	(*)D 3606/D 2267
— saturates	balance		D 1319
Carbon/hydrogen ratio		ratio	
Oxidation stability (5)	480 min		D 525
Existent gum		4 mg/100 ml	D 381
Sulphur content		0,04 % mass	D 1266/D 2622/ D 2785
Copper corrosion at 50 °C		1	D 130
Lead content		0,005 g/l	D 3237
Phosphorous content		0,0013 g/l	D 3231

(\*) Addition of oxygenates prohibited.

## Notes:

- (1) The blending of this fuel must involve use of only conventional European refinery components.
- (2) The values quoted in the specification are 'true values'. In establishment of their limit values the terms of ASTM D 3244 'Defining a basis for petroleum produce quality disputes' have been applied and in fixing a minimum value, a minimum difference of 2R above zero has been taken into account; in fixing a maximum and minimum value, the minimum difference is 4R (R = reproducibility).

Notwithstanding this measure, which is necessary for statistical reasons, the manufacturer of fuel should nevertheless aim at a zero value where the stipulated maximum value is 2R and at the mean value in the case of quotations of maximum and minimum limits. Should it be necessary to clarify the question as to whether a fuel meets the requirements of the specification, the terms of ASTM D 3244 should be applied.

- (3) Equivalent ISO methods will be adopted when issued for all properties listed above.
- (4) The figures quoted show the evaporated quantities (% recovered + % loss).
- (5) The fuel may contain oxidation inhibitors and metal deactivators normally used to stabilize refinery gasoline streams, but detergent/dispersant additives and solvent oils must not be added.

## ▼ M9

## 2. TECHNICAL DATA OF THE REFERENCE FUEL TO BE USED FOR TESTING VEHICLES EQUIPPED WITH A DIESEL ENGINE

CEC reference fuel RF-03-A-84 (1)

Type: diesel fuel

	Limits and Units (2)	ASTM method (3)
Cetane number (4)	min. 49 max. 53	D 613
Density at 15 °C (kg/l)	min. 0,835 max. 0,845	D 1298
Distillation (5)		D 86
— 50 % point	min. 245 °C	
— 90 % point	min. 320 °C max. 340 °C	
— final boiling point	max. 370 °C	
Flash point	min. 55 °C	D 93
CFPP	min. — max. - 5 °C	EN 116 (CEN)
Viscosity 40 °C	min. 2,5 mm <sup>2</sup> /s max. 3,5 mm <sup>2</sup> /s	D 445
Sulphur content (6)	min. to be reported max. 0,3 % mass	D 1266/D 2622/ D 2785
Copper corrosion	max. 1	D 130
Conradson carbon residue (10 % DR)	max. 0,2 % mass	D 189
Ash content	max. 0,01 % mass	D 482
Water content	max. 0,05 % mass	D 95/D 1744
Neutralization (strong acid) number	max. 0,20 mg KOH/g	
Oxidation stability (7)	max. 2,5 mg/100 ml	D 2274
Additives (8)		

*Notes:*

- (1) If it is required to calculate thermal efficiency of an engine or vehicle, the calorific value of the fuel can be calculated from:

Specific energy (calorific value) (net) MJ/kg =

$$(46,423 - 8,792d^2 + 3,170d)(1 - (x + y + s)) + 9,420s - 2,499x.$$

where:

d is the density at 288 K/15 °C,

x is the proportion by mass of water (%/100),

y is the proportion by mass of ash (%/100),

s is the proportion by mass of sulphur (%/100).

- (2) The values quoted in the specification are 'true values'. In establishment of their limit values the terms of ASTM D 3244 'Defining a basis for petroleum produce quality disputes' have been applied and in fixing a minimum value, a minimum difference of 2R above zero has been taken into account; in fixing a maximum and minimum value, the minimum difference is 4R (R = reproducibility).

Notwithstanding this measure, which is necessary for statistical reasons, the manufacturer of fuel should nevertheless aim at a zero value where the stipulated maximum value is 2R and at the mean value in the case of quotations of maximum and minimum limits. Should it be necessary to clarify the question as to whether a fuel meets the requirements of the specification, the terms of ASTM D 3244 should be applied.

- (3) The figures quoted show the evaporated quantities (percentage recovered + percentage loss).
- (4) The range for cetane is not in accordance with the requirement of a minimum range of 4R. However, in cases of dispute between fuel supplier and fuel user, the terms in ASTM D 3244 can be used to resolve such disputes provided replicate measurements, of sufficient number to achieve the necessary precision, are made in preference to single determinations.
- (5) Equivalent ISO methods will be adopted when issued for all properties listed above.
- (6) At the request of the vehicle manufacturer, diesel fuel with a 0,05 % mass maximum sulphur content may be used to represent future market fuel quality, both for type-approval and for conformity of production testing.

**▼ M9**

- (7) Even though oxidation stability is controlled, it is likely that shelf life will be limited. Advice should be sought from the supplier as to storage conditions and life.
- (8) This fuel should be based on straight run and cracked hydrocarbon distillate components only; desulphurization is allowed. It must not contain any metallic additives or cetane improver additives.

▼ **M12***ANNEX IX***MODEL**

(Maximum format: A4 (210 × 297 mm))

## EEC TYPE-APPROVAL CERTIFICATE

Stamp of administration
----------------------------

Communication concerning the

- type-approval <sup>(1)</sup>,
- extension of type-approval <sup>(1)</sup>,
- refusal of type-approval <sup>(1)</sup>,
- withdrawal of type-approval <sup>(1)</sup>,

of a type of a vehicle / component / separate technical unit <sup>(1)</sup> with regard to Directive . . . /EC, as last amended by Directive . . . /EC.

Type-approval number: .....

Reason for extension: .....

## SECTION I

- 0.1. Make (trade name of manufacturer): .....
- 0.2. Type and general commercial description(s): .....
- 0.3. Means of identification of type if marked on the vehicle / component / separate technical unit <sup>(1)</sup> <sup>(2)</sup>: ...
- 0.3.1. Location of that marking: .....
- 0.4. Category of vehicle <sup>(3)</sup>: .....
- 0.5. Name and address of manufacturer: .....
- 0.7. In the case of components and separate technical units, location and method of affixing of the EEC approval mark: .....
- 0.8. Address(es) of assembly plant(s): .....

## SECTION II

1. Additional information (where applicable): See Addendum
2. Technical service responsible for carrying out the tests: .....
3. Date of test report: .....
4. Number of test report: .....
5. Remarks (if any): See Addendum
6. Place: .....
7. Date: .....
8. Signature: .....
9. The index to the information package lodged with the approval authority, which may be obtained on request, is attached.

<sup>(1)</sup> Delete where not applicable.<sup>(2)</sup> If the means of identification of type contains characters not relevant to describe the vehicle, component or separate technical unit types covered by this type-approval certificate such characters shall be represented in the document by the symbol: "?" (e.g. ABC??123??).<sup>(3)</sup> As defined in Annex II A to Directive 70/156/EEC.



▼ **M12***Appendix**Addendum to EEC type-approval certificate No ...*

concerning the type-approval of a vehicle with regard to Directive 70/220/EEC, as last amended by  
Directive .../.../EC

1. Additional information
  - 1.1. Mass of the vehicle in running order: .....
  - 1.2. Maximum mass: .....
  - 1.3. Reference mass: .....
  - 1.4. Number of seats: .....
  - 1.5. Engine identification: .....
  - 1.6. Gearbox
    - 1.6.1. Manual, number of speeds <sup>(1)</sup>: .....
    - 1.6.2. Automatic, number of ratios <sup>(1)</sup>: .....
    - 1.6.3. Continuously variable: yes/no <sup>(1)</sup>
    - 1.6.4. Ratio of the individual gears: .....
    - 1.6.5. Ratio of final drive: .....
  - 1.7. Range of tyre sizes: .....
  - 1.7.1. Rolling circumference of tyres used for the Type I test: .....
  - 1.8. Test results: .....

Type I	CO (g/km)	HC + NO <sub>x</sub> (g/km)	Particulates <sup>(?)</sup> (g/km)
measured			
with DF			

Type II: ..... %

Type III: .....

Type IV: ..... g/test

Type V: — Durability type: 80 000 km, not applicable <sup>(1)</sup>

— Deterioration factor DF: calculated, fixed <sup>(1)</sup>

— Specify the values: .....

5. Remarks: .....

<sup>(1)</sup> Delete where applicable.

<sup>(?)</sup> For compression ignition engines.