STATUTORY INSTRUMENTS

2001 No. 2128

CIVIL AVIATION

The Air Navigation (Overseas Territories) Order 2001

<i>Made</i>	- - - -	<i>9th June 2001</i>
<i>Laid before Parliament</i>		<i>20th June 2001</i>
<i>Coming into force</i>	- -	<i>16th July 2001</i>

At the Court at Buckingham Palace, the 9th day of June 2001

Present,

The Queen's Most Excellent Majesty in Council

Her Majesty, in exercise of the powers conferred on Her by Sections 8, 41, 57, 58, 59 and 61 of the Civil Aviation Act 1949⁽¹⁾ as extended to certain territories by the Civil Aviation Act 1949 (Overseas Territories) Order 1969⁽²⁾, as amended by the Civil Aviation Act 1982 (Overseas Territories) Order 2001⁽³⁾, and all other powers enabling Her in that behalf, is pleased, by and with the advice of Her Privy Council, to order, and it is hereby ordered, as follows:

Citation, Commencement and Revocation

Citation and Commencement

1. This Order may be cited as the Air Navigation (Overseas Territories) Order 2001 and shall come into force on 16th July 2001.

Revocation

2. The Orders specified in the Schedule 1 to this Order are hereby revoked, except insofar as they apply to Gibraltar.

(1) 1949 c. 67.
(2) S.I. 1969/592.
(3) S.I. 2001/1452.

PART I

Registration and Marking of Aircraft

Aircraft to be registered

3.—(1) Subject to paragraph (2) an aircraft shall not fly in or over the Territory unless it is registered in:

- (a) some part of the Commonwealth;
 - (b) a Contracting State; or
 - (c) some other country in relation to which there is in force an agreement between Her Majesty's Government in the United Kingdom and the Government of that country which makes provision for the flight over the Territory of aircraft registered in that country.
- (a) (2) (a) A glider may fly unregistered, and shall be deemed to be registered in the Territory for the purposes of articles 14, 15, 21 and 43 of this Order, on any flight which:
- (i) begins and ends in the Territory without passing over any other country, and
 - (ii) is not for the purpose of public transport or aerial work other than aerial work which consists of the giving of instruction in flying or the conducting of flying tests in a glider owned or operated by a flying club of which the person giving the instruction or conducting the test and the person receiving the instruction or undergoing the test are both members.
- (b) Any aircraft may fly unregistered on any flight which:
- (i) begins and ends in the Territory without passing over any other country, and
 - (ii) is in accordance with the "B Conditions" set forth in Part A of Schedule 3 to this Order.
- (c) Paragraph (1) shall not apply to any kite or captive balloon.

(3) If an aircraft flies over the Territory in contravention of paragraph (1) in such manner or circumstances that if the aircraft had been registered in the Territory an offence against this Order or any regulations made thereunder would have been committed, the like offence shall be deemed to have been committed in respect of that aircraft.

Registration of aircraft in the Territory

4.—(1) The Governor shall be the authority for the registration of aircraft in the Territory and shall be responsible for maintaining the register and may record therein the particulars specified in paragraph (7) in a legible or a non-legible form so long as the recording is capable of being reproduced in a legible form.

(2) Subject to the provisions of this article, an aircraft shall not be registered or continue to be registered in the Territory if it appears to the Governor that:

- (a) the aircraft is registered outside the Territory and that such registration does not cease by operation of law upon the aircraft being registered in the Territory;
- (b) an unqualified person holds any legal or beneficial interest by way of ownership in the aircraft or any share therein;
- (c) the aircraft could more suitably be registered in some other part of the Commonwealth; or
- (d) it would be inexpedient in the public interest for the aircraft to be or to continue to be registered in the Territory.

(3) The following persons and no others shall be qualified to hold a legal or beneficial interest by way of ownership in an aircraft registered in the Territory or a share therein:

- (a) the Crown in right of Her Majesty's Government in the United Kingdom or in right of the Government of the Territory;
- (b) Commonwealth citizens;
- (c) citizens of the Republic of Ireland;
- (d) British protected persons;
- (e) bodies incorporated in some part of the Commonwealth and having their principal place of business in any part of the Commonwealth; or
- (f) firms carrying on business in Scotland.

In this sub-paragraph "firm" has the same meaning as in the Partnership Act 1890(4)

- (a) (4) (a) If any unqualified person residing of having a place of business in the Territory holds a legal or beneficial interest by way of ownership in an aircraft, or a share therein, the Governor, upon being satisfied that the aircraft may otherwise be properly so registered, may register the aircraft in the Territory.
- (b) The person aforesaid shall not cause or permit the aircraft, while it is registered in pursuance of this paragraph, to be used for the purpose of public transport or aerial work.

(5) If an aircraft is chartered to a person qualified as aforesaid the Governor may, whether or not an unqualified person is entitled as owner to a legal or beneficial interest therein, register the aircraft in the Territory in the name of the charterer upon being satisfied that the aircraft may otherwise be properly so registered, and subject to the provisions of this article the aircraft may remain so registered during the continuation of the charter.

(6) Application for the registration of an aircraft in the Territory shall be made in writing to the Governor, and shall include or be accompanied by such particulars and evidence relating to the aircraft and the ownership and chartering thereof as he may require to enable him to determine whether the aircraft may properly be registered in the Territory and to issue the certificate referred to in paragraph (8). In particular, the application shall include the proper description of the aircraft according to column 4 of the "General classification of aircraft" set forth in Part A of Schedule 2 to this Order.

(7) Upon receiving an application for the registration of an aircraft in the Territory and being satisfied that the aircraft may properly be so registered, the Governor shall register the aircraft, wherever it may be, and shall include in the register the following particulars:

- (a) the number of the certificate;
- (b) the nationality mark of the aircraft, and the registration mark assigned to it by the Governor;
- (c) the name of the constructor of the aircraft and its designation;
- (d) the serial number of the aircraft; and
- (e) (i) the name and address of every person who is entitled as owner to a legal interest in the aircraft or a share therein, or in the case of an aircraft which is the subject of a charter by demise, the name and address of the charterer by demise; and
(ii) in the case of an aircraft registered in pursuance of paragraphs (4) or (5), an indication that it is so registered.

- (a) (8) (a) Subject to sub-paragraph (b) the Governor shall furnish to the person in whose name the aircraft is registered (hereinafter in this article referred to as the "the registered

owner”) a certificate of registration, which shall include the foregoing particulars and the date on which the certificate was issued.

- (b) The Governor shall not be required to furnish a certificate of registration if the registered owner is the holder of an aircraft dealer’s certificate granted under this Order who has made to the Governor and has not withdrawn a statement of his intention that the aircraft is to fly only in accordance with the conditions set forth in Part C of Schedule 2 to this Order, and in that case the aircraft shall fly only in accordance with those conditions.

(9) The Governor may grant to any person qualified as aforesaid an aircraft dealer’s certificate if he is satisfied that he has a place of business in the Territory for buying and selling aircraft.

(10) Subject to paragraphs (4) and (5), if at any time after an aircraft has been registered in the Territory an unqualified person becomes entitled to a legal or beneficial interest by way of ownership in the aircraft or a share therein, the registration of the aircraft shall thereupon become void and the certificate of registration shall forthwith be returned by the registered owner to the Governor.

(11) Any person who is the registered owner of an aircraft registered in the Territory shall forthwith inform the Governor in writing of:

- (a) any change in the particulars which were furnished to the Governor upon application being made for the registration of the aircraft;
- (b) the destruction of the aircraft, or its permanent withdrawal from use; or
- (c) in the case of an aircraft registered in pursuance of paragraph (5), the termination of the demise charter.

(12) Any person who becomes the owner of an aircraft registered in the Territory shall within 28 days inform the Governor in writing to that effect.

(13) The Governor may, whenever it appears to him necessary or appropriate to do so for giving effect to this Part of this Order or for bringing up to date or otherwise correcting the particulars entered on the register, amend the register or, if he thinks fit, may cancel the registration of the aircraft, and shall cancel that registration within two months of being satisfied that there has been a change in the ownership of the aircraft.

(14) The Governor may, by regulations, adapt or modify the foregoing provisions of this article as he deems necessary or expedient for the purpose of providing for the temporary transfer of aircraft to or from the Territory register, either generally or in relation to a particular case or class of cases.

(15) In this article references to an interest in an aircraft do not include references to an interest in an aircraft to which a person is entitled only by virtue of his membership of a flying club and the reference in paragraph (11) to the registered owner of an aircraft includes, in the case of a deceased person, his legal personal representative, and in the case of a body corporate which has been dissolved, its successor.

(16) Nothing in this article shall require the Governor to cancel the registration of an aircraft if in his opinion it would be inexpedient in the public interest to do so.

(17) The registration of an aircraft which is the subject of an undischarged mortgage entered in the Register of Aircraft Mortgages kept in the Territory pursuant to an Order in Council made under section 86 of the Civil Aviation Act 1982(5) which extends to the Territory or pursuant to other legislation in force in the Territory relating to the mortgaging of aircraft, shall not become void by virtue of paragraph (10) of this Article, nor shall the Governor cancel the registration of such an aircraft pursuant to this Article unless all persons shown in the Register of Aircraft Mortgages as mortgagees of that aircraft have consented to the cancellation.

(18) The Governor shall, at such times and in such a manner as may from time to time be directed by the Civil Aviation Authority, transmit to the Civil Aviation Authority particulars of all registrations and of changes in or cancellations of registrations, entered in the register.

Nationality and registration marks

5.—(1) An aircraft (other than an aircraft permitted by or under this Order to fly without being registered) shall not fly unless it bears painted thereon or affixed thereto, in the manner required by the law of the country in which it is registered, the nationality and registration marks required by that law.

(2) The marks to be borne by aircraft registered in the Territory shall comply with Part B of Schedule 2 to this Order.

(3) Subject to paragraph (4), an aircraft shall not bear any marks which purport to indicate:

- (a) that the aircraft is registered in a country in which it is not in fact registered, or
- (b) that the aircraft is a State aircraft of a particular country if it is not in fact such an aircraft, unless the appropriate authority of that country has sanctioned the bearing of such marks.

(4) Marks approved by the Governor for the purposes of flight in accordance with the 'B Conditions' contained in Part A of Schedule 3 to this Order shall be deemed not to purport to indicate that the aircraft is registered in a country in which it is not in fact registered.

PART II

Air Operators' Certificates

Issue of air operators' certificates

6.—(1) Subject to article 7 of this Order, an aircraft registered in the Territory shall not fly on any flight for the purpose of public transport, otherwise than under and in accordance with the terms of an air operator's certificate granted to the operator of the aircraft under paragraph (2), certifying that the holder of the certificate is competent to secure that aircraft operated by him on such flights as that in question are operated safely.

- (a) (2) (a) The Governor shall grant an air operator's certificate if he is satisfied that the applicant is competent, having regard in particular to his previous conduct and experience, his equipment, organisation, staffing, maintenance and other arrangements, to secure the safe operation of aircraft of the types specified in the certificate on flights of the description and for the purposes so specified.
- (b) A certificate may be granted subject to such conditions as the Governor thinks fit and shall, subject to article 81 of this Order, remain in force for the period specified in the certificate.

Issue of police air operators' certificates

7.—(1) A flight by an aircraft registered in the Territory in the service of the police authority for the Territory (in this Order called 'the police authority') shall, for the purposes of this Order, be deemed to be a flight for the purpose of public transport and if any passenger is carried the flight shall be deemed to be for the purpose of public transport of passengers, and save as otherwise expressly provided, the provisions of this Order and of any regulations made thereunder shall be complied with in relation to any such flight as if that flight was for the purpose of public transport or public transport of passengers as the case may be.

(2) An aircraft registered in the Territory shall not fly on any flight in the service of the police authority otherwise than under and in accordance with either the terms of an air operator's certificate

granted to the operator of the aircraft under article 6(2) of this Order or the terms of a police air operator's certificate granted to the operator of the aircraft under paragraph (3), certifying that the holder of the certificate is competent to secure that aircraft operated by him on flights for the purpose of police operations are operated as safely as is appropriate having regard to the particular purposes of the flight.

(3) The Governor shall grant a police air operator's certificate (in this Order called 'a police air operator's certificate') if he is satisfied that the applicant is competent having regard in particular to his previous conduct and experience, his equipment, organisation, staffing, maintenance and other arrangements, to secure that the operation of aircraft of the types specified in the certificate shall be as safe as is appropriate when flying on flights of the description and for the purposes so specified. The certificate may be granted subject to such conditions as the Governor thinks fit and shall, subject to article 81 of this Order, remain in force for the period specified in the certificate.

PART III

Airworthiness and Equipment of Aircraft

Certificate of airworthiness to be in force

8.—(1) Subject to paragraph (2) an aircraft shall not fly unless there is in force in respect thereof a certificate of airworthiness duly issued or rendered valid under the law of the country in which the aircraft is registered or the State of the operator, and any conditions subject to which the certificate was issued or rendered valid are complied with.

(2) The foregoing prohibition shall not apply to flights, beginning and ending in the Territory without passing over any other country, of:

- (a) a glider, if it is not being used for the public transport of passengers or aerial work other than aerial work which consists of the giving of instruction in flying or the conducting of flying tests in a glider owned or operated by a flying club of which the person giving the instruction or conducting the test and the person receiving the instruction or undergoing the test are both members;
- (b) a balloon flying on a private flight;
- (c) a kite;
- (d) an aircraft flying in accordance with the 'A Conditions' or the 'B Conditions' set forth in Part A of Schedule 3 to this Order; or
- (e) an aircraft flying in accordance with the conditions of a permit to fly issued by the Governor in respect of that aircraft.

(3) In the case of an aircraft registered in the Territory the certificate of airworthiness referred to in paragraph (1) shall be a certificate issued or rendered valid in accordance with the provisions of article 9 of this Order.

Issue, renewal, etc., of certificates of airworthiness

9.—(1) The Governor shall issue in respect of any aircraft a certificate of airworthiness if he is satisfied that the aircraft is fit to fly having regard to:

- (a) the design, construction, workmanship and materials of the aircraft (including in particular any engines fitted therein), and of any equipment carried in the aircraft which he considers necessary for the airworthiness of the aircraft; and
- (b) (i) Subject to sub-paragraph (ii) the results of flying trials, and such other tests of the aircraft as he may require:

(ii) if the Governor has issued a certificate of airworthiness in respect of an aircraft which, in his opinion, is a prototype aircraft or a modification of a prototype aircraft, he may dispense with flying trials in the case of any other aircraft if he is satisfied that it conforms to such prototype or modification.

(2) Every certificate of airworthiness shall specify such categories as are, in the opinion of the Governor, appropriate to the aircraft in accordance with Part B of Schedule 3 to this Order and the certificate shall be issued subject to the condition that the aircraft shall be flown only for the purposes indicated in the said Schedule in relation to those categories.

(3) The Governor may issue the certificate of airworthiness subject to such other conditions relating to the airworthiness of the aircraft as he thinks fit.

(4) The certificate of airworthiness may designate the performance group to which the aircraft belongs for the purposes of the requirements referred to in article 36(1) of this Order.

(5) The Governor may, subject to such conditions as he thinks fit, issue a certificate of validation rendering valid for the purposes of this Order a certificate of airworthiness issued in respect of any aircraft under the law of any country other than the Territory.

(6) Subject to the provisions of this article and of article 81 of this Order, a certificate of airworthiness or validation issued under this article shall remain in force for such a period as may be specified therein, and may be renewed from time to time by the Governor for such further period as he thinks fit.

(7) A certificate of airworthiness or a certificate of validation issued in respect of an aircraft shall cease to be in force:

- (a) if the aircraft, or such of its equipment as is necessary for the airworthiness of the aircraft, is overhauled, repaired or modified, or if any part of the aircraft or of such equipment is removed or is replaced, otherwise than in a manner and with material of a type approved by the Governor either generally or in relation to a class of aircraft or to the particular aircraft;
- (b) until the completion of any inspection or maintenance of the aircraft or of any such equipment as aforesaid, being an inspection made for the purpose of ascertaining whether the aircraft remains airworthy and:
 - (i) classified as mandatory by the Governor;
 - (ii) required by a maintenance schedule approved by the Governor in relation to that aircraft; or
- (c) until the completion to the satisfaction of the Governor of any modification of the aircraft or of any such equipment as aforesaid, being a modification required by the Governor for the purpose of ensuring that the aircraft remains airworthy.

(8) Nothing in this Order shall oblige the Governor to accept an application for the issue of a certificate of airworthiness or validation or for the variation or renewal of any such certificate when the application is not supported by such reports from such approved persons as the Governor may specify (either generally or in a particular case or class of cases).

Certificate of maintenance review

- (a) **10.** (1) (a) An aircraft registered in the Territory in respect of which a certificate of airworthiness is in force shall not fly unless the aircraft (including in particular its engines), together with its equipment and radio station, is maintained in accordance with a maintenance schedule approved by the Governor in relation to that aircraft.
- (b) An aircraft registered in the Territory in respect of which a certificate of airworthiness in either the transport or in the aerial work category is in force shall not fly unless there is in force a certificate (in this Order referred to as a 'certificate of maintenance review')

issued in respect of the aircraft in accordance with the provisions of this article and such certificate shall certify the date on which the maintenance review was carried out and the date when the next review is due.

(2) A maintenance schedule approved pursuant to paragraph (1) in relation to an aircraft in respect of which there has been issued a certificate of airworthiness in either the transport or in the aerial work category shall specify the occasions on which a review must be carried out for the purpose of issuing a certificate of maintenance review.

(a) (3) (a) Subject to sub-paragraph (b), a certificate of maintenance review may be issued for the purposes of this article only by:

(i) the holder of an aircraft maintenance engineer's licence:

(aa) granted under this Order, being a licence which entitles him to issue that certificate;

(bb) granted under the law of a country other than the Territory and rendered valid under this Order in accordance with the privileges endorsed on the licence; or

(cc) granted under the law of any country specified in regulation 15 in Schedule 14 to this Order in accordance with the privileges endorsed on the licence and subject to any conditions which may be prescribed.

(ii) a person whom the Governor has authorised to issue a certificate of maintenance review in a particular case, and in accordance with that authority; or

(iii) a person approved by the Governor as being competent to issue such a certificate, and in accordance with that approval.

(b) In approving a maintenance schedule, the Governor may direct that certificates of maintenance review relating to that schedule, or to any part thereof specified in his direction, may be issued only by the holder of such a licence as is so specified.

(4) A person referred to in paragraph (3) shall not issue a certificate of maintenance review unless he has first verified that:

(a) maintenance has been carried out on the aircraft in accordance with the maintenance schedule approved for that aircraft;

(b) inspections and modifications required by the Governor as provided in article 9 of this Order have been completed as certified in the relevant certificate of release to service issued under this Order;

(c) defects entered in the technical log of the aircraft in accordance with article 11 of this Order have been rectified or the rectification thereof has been deferred in accordance with procedures approved by the Governor; and

(d) certificates of release to service have been issued under this Order and for this purpose the operator of the aircraft shall make available to that person such information as is necessary.

(a) (5) (a) A certificate of maintenance review shall be issued in duplicate.

(b) One copy of the most recently issued certificate shall be carried in the aircraft when article 76 of this Order so requires, and the other shall be kept by the operator elsewhere than in the aircraft.

(6) Subject to article 80 of this Order, each certificate of maintenance review shall be preserved by the operator of the aircraft for a period of two years after it has been issued.

Technical Log

11.—(1) A technical log shall be kept in respect of every aircraft registered in the Territory in respect of which a certificate of airworthiness in either the transport or in the aerial work category is in force.

- (a) (2) (a) Subject to sub-paragraph (b), at the end of every flight by an aircraft to which the provisions of this article apply the commander of the aircraft shall enter:
- (i) the times when the aircraft took off and landed;
 - (ii) particulars of any defect which is known to him and which affects the airworthiness or safe operation of the aircraft, or if no such defect is known to him, an entry to that effect; and
 - (iii) such other particulars in respect of the airworthiness or operation of the aircraft as the Governor may require;

in a technical log, or, in the case of an aircraft of which the maximum total weight authorised does not exceed 2730 kg and which is not operated by a person who is the holder of or is required by article 6(1) of this Order to hold an air operator's certificate, in such other record as the Governor shall approve, and the commander shall sign and date such entries.

- (b) In the case of a number of consecutive flights each of which begins and ends:
- (i) within the same period of 24 hours.
 - (ii) at the same aerodrome, except where each such flight is for the purpose of dropping or projecting any material for agricultural, public health or similar purposes; and
 - (iii) with the same person as commander of the aircraft:

the commander of an aircraft may, except where he becomes aware of a defect during an earlier flight, make the entries specified in sub-paragraph (a) in a technical log at the end of the last of such consecutive flights.

(3) Upon the rectification of any defect which has been entered in a technical log in accordance with paragraph (2) a person issuing a certificate of release to service issued under this Order in respect of that defect shall enter the certificate in the technical log in such a position as to be readily identifiable with the defect to which it relates.

- (a) (4) (a) Subject to sub-paragraph (b), the technical log referred to in this article shall be carried in the aircraft when article 76 of this Order so requires and copies of the entries referred to in this article shall be kept on the ground.
- (b) In the case of an aeroplane of which the maximum total weight authorised does not exceed 2730 kg, or a helicopter, if it is not reasonably practicable for the copy of the technical log to be kept on the ground it may be carried in the aeroplane or helicopter, as the case may be, in a container approved by the Governor for that purpose.

(5) Subject to article 80 of this Order, a technical log or such other approved record required by this article shall be preserved by the operator of the aircraft to which it relates until a date 2 years after the aircraft has been destroyed or has been permanently withdrawn from use, or for such shorter period as the Governor may permit in a particular case.

Inspection, overhaul, repair, replacement and modification

12.—(1) This article shall apply to any aircraft registered in the Territory in respect of which a certificate of airworthiness issued or rendered valid under this Order is in force.

(2) Except as provided in paragraphs (4) and (5) an aircraft to which this article applies shall not fly unless there is in force a certificate of release to service issued under this Order if the aircraft or

any part of the aircraft or such of its equipment as is necessary for the airworthiness of the aircraft has been overhauled, repaired, replaced, modified, maintained or has been inspected as provided in article 9(7)(b) of this Order, as the case may be.

(3) If a repair or replacement of a part of an aircraft or its equipment is carried out when the aircraft is at such a place that it is not reasonably practicable:

- (a) for the repair or replacement to be carried out in such a manner that a certificate of release to service under this Order can be issued in respect thereof; or
- (b) for such a certificate to be issued while the aircraft is at that place;

it may fly to a place at which such a certificate can be issued, being the nearest place:

- (i) to which the aircraft can, in the reasonable opinion of the commander thereof, safely fly by a route for which it is properly equipped; and
- (ii) to which it is reasonable to fly having regard to any hazards to the liberty or health of any person on board;

and in such case the commander of the aircraft shall cause written particulars of the flight, and the reasons for making it, to be given to the Governor within 10 days thereafter.

(4) A certificate of release to service shall not be required to be in force in respect of an aircraft to which this article applies of which the maximum total weight authorised does not exceed 2730 kg and in respect of which a certificate of airworthiness in the special category is in force, unless the Governor gives a direction to the contrary in a particular case.

- (a) (5) (a) A certificate of release to service shall not be required to be in force in respect of an aircraft to which this article applies of which the maximum total weight authorised does not exceed 2730 kg and in respect of which a certificate of airworthiness in the private or special categories is in force if it flies in the circumstances specified in sub-paragraph (b).
- (b) (i) The only repairs or replacements in respect of which a certificate of release to service is not in force are of such a description as are specified in regulation 17 in Schedule 14 to this Order.
- (ii) Such repairs or replacements have been carried out personally by the holder of a pilot's licence granted or rendered valid under this Order who is the owner or operator of the aircraft.
- (iii) The person carrying out the repairs or replacements shall keep in the aircraft log book kept in respect of the aircraft pursuant to article 17 of this Order a record which identifies the repairs or replacement and shall sign and date the entries.
- (iv) Any equipment or parts used in carrying out such repairs or replacements shall be of a type approved by the Governor either generally or in relation to a class of aircraft or one particular aircraft.
- (c) The person responsible for keeping the aircraft log book shall, subject to article 80 of this Order, preserve the log book for the period specified in article 17 of this Order.

(6) Neither:

- (a) equipment provided in compliance with Schedule 4 to this Order (except paragraph 3 thereof); nor
- (b) radio apparatus provided for use in an aircraft or in any survival craft carried in an aircraft, whether or not such apparatus is provided in compliance with this Order or any regulations made thereunder,

shall be installed or placed on board for use in an aircraft to which this article applies after being overhauled, repaired, modified or inspected, unless there is in force in respect thereof at the time when it is installed or placed on board a certificate of release to service issued under this Order.

- (7) A certificate of release to service issued under this Order shall:
- (a) certify that the aircraft or any part thereof or its equipment has been overhauled, repaired, replaced, modified or maintained, as the case may be, in a manner and with material of a type approved by the Governor either generally or in relation to a class of aircraft or the particular aircraft and shall identify the overhaul, repair, replacement, modification or maintenance to which the certificate relates and shall include particulars of the work done; or
 - (b) certify in relation to any inspection required by the Governor that the aircraft or the part thereof or its equipment, as the case may be, has been inspected in accordance with the requirements of the Governor and that any consequential repair, replacement or modification has been carried out as aforesaid.
- (8) A certificate of release to service issued under this Order may be issued only by:
- (a) the holder of an aircraft maintenance engineer's licence:
 - (i) granted under this Order, being a licence which entitles him to issue that certificate;
 - (ii) granted under the law of a country other than the Territory and rendered valid under this Order, in accordance with the privileges endorsed on the licence; or
 - (iii) granted under the law of any country specified in regulation 15 in Schedule 14 to this Order in accordance with the privileges endorsed on the licence and subject to any conditions which may be prescribed;
 - (b) the holder of an aircraft maintenance engineer's licence or authorisation as such an engineer granted or issued by or under the law of any Contracting State other than the Territory in which the overhaul, repair, replacement, modification or inspection has been carried out, but only in respect of aircraft to which this article applies of which the maximum total weight authorised does not exceed 2730 kg and in accordance with the privileges endorsed on the licence;
 - (c) a person approved by the Governor as being competent to issue such certification, and in accordance with that approval;
 - (d) a person whom the Governor has authorised to issue the certificate in a particular case, and in accordance with that authority; or
 - (e) in relation only to the adjustment and compensation of direct reading magnetic compasses, the holder of an Airline Transport Pilot's Licence (Aeroplanes) or a Flight Navigator's Licence granted or rendered valid under this Order.
- (9) In this article, the expression "repair" includes in relation to a compass the adjustment and compensation thereof and the expression "repaired" shall be construed accordingly.

Licensing of maintenance engineers

13.—(1) The Governor shall grant aircraft maintenance engineers' licences, subject to such conditions as he thinks fit, upon being satisfied that the applicant is a fit person to hold the licence and is qualified by reason of his knowledge, experience, competence and skill in aeronautical engineering, and for that purpose the applicant shall furnish such evidence and undergo such examinations and tests as the Governor may require of him.

(2) An aircraft maintenance engineer's licence shall authorise the holder, subject to such conditions as may be specified in the licence, to issue:

- (a) certificates of maintenance review in respect of such aircraft as may be so specified;
- (b) certificates of release to service under this Order in respect of such overhauls, repairs, replacements, modifications, maintenance and inspections of such aircraft and such equipment as may be so specified; or

- (c) certificates of fitness for flight under “A Conditions” in respect of such aircraft as may be so specified.
- (3) A licence shall, subject to article 81 of this Order, remain in force for the period specified therein, not exceeding five years, but may be renewed by the Governor from time to time upon his being satisfied that the applicant is a fit person and is qualified as aforesaid.
- (a) (4) (a) The Governor may issue a certificate rendering valid for the purposes of this Order any licence as an aircraft maintenance engineer granted under the law of any country other than the Territory.
- (b) Such a certificate may be issued subject to conditions, and for such periods, as the Governor thinks fit.
- (5) A licence granted under this article shall not be valid unless it bears thereon the ordinary signature of the holder in ink.
- (6) Without prejudice to any other provision of this Order the Governor may, for the purposes of this article, either absolutely or subject to such conditions as he thinks fit:
- (a) approve any course of training or instruction;
- (b) authorise a person to conduct such examinations or tests as he may specify; and
- (c) approve a person to provide or conduct any course of training or instruction.
- (7) The holder of an aircraft maintenance engineer’s licence shall not exercise the privileges of such a licence if he knows or suspects that his physical or mental condition renders him unfit to exercise such privileges.
- (8) The holder of an aircraft maintenance engineer’s licence shall not, when exercising the privileges of such a licence, be under the influence of drink or a drug to such an extent as to impair his capacity to exercise such privileges.

Equipment of aircraft

- 14.—(1) An aircraft shall not fly unless it is so equipped as to comply with the law of the country in which it is registered, and to enable lights and markings to be displayed, and signals to be made, in accordance with this Order and any regulations made thereunder.
- (2) In the case of any aircraft registered in the Territory the equipment required to be provided (in addition to any other equipment required by or under this Order) shall:
- (a) be that specified in such parts of Schedule 4 to this Order as are applicable in the circumstances;
- (b) comply with the provisions of that Schedule;
- (c) except that specified in paragraph 3 of the said Schedule, be of a type approved by the Governor either generally or in relation to a class of aircraft or in relation to that aircraft; and
- (d) be installed in a manner so approved.
- (3) In any particular case the Governor may direct that an aircraft registered in the Territory shall carry such additional or special equipment or supplies as he may specify for the purpose of facilitating the navigation of the aircraft, the carrying out of search and rescue operations or the survival of the persons carried in the aircraft.
- (4) The equipment carried in compliance with this article shall be so installed or stowed and kept stowed, and so maintained and adjusted as to be readily accessible and capable of being used by the person for whose use it is intended.
- (a) (5) (a) The position of equipment provided for emergency use shall be indicated by clear markings in or on the aircraft.

- (b) In every public transport aircraft registered in the Territory there shall be provided individually for each passenger or, if the Governor so permits in writing, exhibited in a prominent position in every passenger compartment, a notice which complies with subparagraph (c).
- (c)
 - (i) The required notice shall be relevant to the aircraft in question;
 - (ii) The required notice shall contain pictorial instructions on the brace position to be adopted in the event of an emergency landing;
 - (iii) The required notice shall contain pictorial instructions on the method of use of the safety belts and safety harnesses as appropriate;
 - (iv) The required notice shall contain pictorial information as to where emergency exits are to be found and instructions as to how they are to be used;
 - (v) The required notice shall contain pictorial information as to where the lifejackets, escape slides, liferafts and oxygen masks, if required to be provided by paragraph (2), are to be found and instructions as to how they are to be used.

(6) All equipment installed or carried in an aircraft, whether or not in compliance with this article, shall be so installed or stowed and so maintained and adjusted as not to be a source of danger in itself or to impair the airworthiness of the aircraft or the proper functioning of any equipment or services necessary for the safety of the aircraft.

(7) Without prejudice to paragraph (2), all navigational equipment (other than radio apparatus) of any of the following types, namely:

- (a) equipment capable of establishing the aircraft's position in relation to its position at some earlier time by computing and applying the resultant of the acceleration and gravitational forces acting upon it; and
- (b) equipment capable of establishing automatically the altitude and relative bearing of selected celestial bodies;

when carried in an aircraft registered in the Territory (whether or not in compliance with this Order or any regulations made thereunder) shall be of a type approved by the Governor either generally or in relation to a class of aircraft or in relation to that aircraft and shall be installed in a manner so approved.

(8) This article shall not apply in relation to radio apparatus except that specified in Schedule 4 to this Order.

Radio equipment of aircraft

15.—(1) An aircraft shall not fly unless it is so equipped with radio and radio navigation equipment as to comply with the law of the country in which the aircraft is registered or the State of the operator and to enable communications to be made and the aircraft to be navigated, in accordance with the provisions of this Order and any regulations made thereunder, and in particular Schedule 14 to this Order.

(2) Without prejudice to paragraph (1), the aircraft shall be equipped with radio and radio navigation equipment in accordance with Schedule 5 to this Order.

(3) In any particular case the Governor may direct that an aircraft registered in the Territory shall carry such additional or special radio or radio navigation equipment as he may specify for the purpose of facilitating the navigation of the aircraft, the carrying out of search and rescue operations or the survival of the persons carried in the aircraft.

(4) Subject to such exceptions as may be prescribed the radio and radio navigation equipment provided in compliance with this article in an aircraft registered in the Territory shall always be maintained in serviceable condition.

(5) All radio and radio navigation equipment installed in an aircraft registered in the Territory or carried on such an aircraft for use in connection with the aircraft (whether or not in compliance with this Order or any regulations made thereunder) shall be of a type approved by the Governor in relation to the purpose for which it is to be used, and shall, except in the case of a glider which is permitted by article 3(2) of this Order to fly unregistered, be installed in a manner approved by the Governor. Neither the equipment nor the manner in which it is installed shall be modified except with the approval of the Governor.

Minimum equipment requirements

16.—(1) The Governor may, subject to such conditions as he thinks fit, grant in respect of any aircraft or class of aircraft registered in the Territory a permission permitting such aircraft to commence a flight in specified circumstances notwithstanding that any specified item of equipment (including radio apparatus) required by or under this Order to be carried in the circumstances of the intended flight is not carried or is not in a fit condition for use.

(2) An aircraft registered in the Territory shall not commence a flight if any of the equipment (including radio apparatus) required by or under this Order to be carried in the circumstances of the intended flight is not carried or is not in a fit condition for use:

- (a) otherwise than under and in accordance with the terms of a permission under this article which has been granted to the operator; and
- (b) unless in the case of an aircraft to which article 31 of this Order applies, the operations manual required thereby contains the particulars specified at sub-paragraph (xvii) of Part A of Schedule 10 to this Order; and
- (c) unless in the case of an aircraft to which article 32 of this Order applies, the police operations manual required thereby contains the particulars specified in sub-paragraph (xvii) of Part A of Schedule 10 to this Order.

Aircraft, engine and propeller log books

17.—(1) In addition to any other log books required by or under this Order, the following log books shall be kept in respect of aircraft registered in the Territory:

- (a) an aircraft log book;
- (b) a separate log book in respect of each engine fitted in the aircraft; and
- (c) a separate log book in respect of each variable pitch propeller fitted to the aircraft.

(2) The log books shall include the particulars respectively specified in Schedule 6 to this Order and in the case of an aircraft having a maximum total weight authorised not exceeding 2730 kg, shall be of a type approved by the Governor.

- (a) (3) (a) Each entry in the log book, other than such an entry as is referred to in sub-paragraphs 2(d)(ii) or 3(d)(ii) of Schedule 6 to this Order, shall be made as soon as practicable after the occurrence to which it relates, but in no event more than seven days after the expiration of the certificate of maintenance review (if any) in force in respect of the aircraft at the time of the occurrence.
- (b) Each entry in the log book, being such an entry as is referred to in sub-paragraphs 2(d)(ii) or 3(d)(ii) of Schedule 6 to this Order shall be made upon each occasion that any maintenance, overhaul, repair, replacement, modification or inspection is undertaken on the engine or propeller, as the case may be.

(4) Any document which is incorporated by reference in a log book shall be deemed, for the purposes of this Order, to be part of the log book.

(5) It shall be the duty of the operator of every aircraft in respect of which log books are required to be kept as aforesaid to keep them or cause them to be kept in accordance with the foregoing provisions of this article.

(6) Subject to article 80 of this Order every log book shall be preserved by the operator of the aircraft until a date 2 years after the aircraft, the engine or the variable pitch propeller, as the case may be, has been destroyed or has been permanently withdrawn from use.

Aircraft weight schedule

18.—(1) Every flying machine and glider in respect of which a certificate of airworthiness issued or rendered valid under this Order is in force shall be weighed, and the position of its centre of gravity determined, at such times and in such manner as the Governor may require or approve in the case of that aircraft.

(2) Upon the aircraft being weighed as aforesaid the operator of the aircraft shall prepare a weight schedule showing:

- (a) either the basic weight of the aircraft, that is to say, the weight of the aircraft empty together with the weight of unusable fuel and unusable oil in the aircraft and of such items of equipment as are indicated in the weight schedule, or such other weight as may be approved by the Governor in the case of that aircraft; and
- (b) either the position of the centre of gravity of the aircraft when the aircraft contains only the items included in the basic weight or such other position of the centre of gravity as may be approved by the Governor in the case of that aircraft.

(3) Subject to article 80 of this Order the weight schedule shall be preserved by the operator of the aircraft until the expiration of a period of six months following the next occasion on which the aircraft is weighed for the purposes of this article.

Access and inspection for airworthiness purposes

19. The Governor may cause such inspections, investigations, tests, experiments and flight trials to be made as he deems necessary for the purposes of this Part of this Order and any person authorised to do so in writing by the Governor may at any reasonable time inspect any part of, or material intended to be incorporated in or used in the manufacture of any part of, an aircraft or its equipment or any document relating thereto and may for that purpose go upon any aerodrome or enter any aircraft factory.

PART IV

Aircraft Crew and Licensing

Composition of crew of aircraft

20.—(1) An aircraft shall not fly unless it carries a flight crew of the number and description required by the law of the country in which it is registered.

(2) An aircraft registered in the Territory shall carry a flight crew adequate in number and description to ensure the safety of the aircraft and of at least the number and description specified in the certificate of airworthiness issued or rendered valid under this Order or, if no certificate of airworthiness is required under this Order to be in force, the certificate of airworthiness, if any, last in force under this Order in respect of that aircraft.

- (a) (3) (a) A flying machine registered in the Territory and flying for the purpose of public transport having a maximum total weight authorised exceeding 5,700 kg shall carry not less than two pilots as members of the flight crew thereof.
- (b) (i) Subject to sub-paragraphs (ii) and (iii), an aeroplane registered in the Territory and flying for the purpose of public transport in circumstances where the aircraft commander is required to comply with the Instrument Flight Rules and having a maximum total weight authorised of 5,700 kg or less and powered by:
 - (aa) one or more turbine jets;
 - (bb) one or more turbine propeller engines and provided with a means of pressurising the personnel compartments;
 - (cc) two or more turbine propeller engines and certificated to carry more than nine passengers;
 - (dd) two or more turbine propeller engines and certificated to carry fewer than 10 passengers and not provided with a means of pressurising the personnel compartments, unless it is equipped with an autopilot which has been approved by the Governor for the purposes of this article and which is serviceable on take-off; or
 - (ee) two or more piston engines, unless it is equipped with an autopilot which has been approved by the Governor for the purposes of this article and which is serviceable on take-off;

shall carry not less than two pilots as members of the flight crew thereof.

 - (ii) An aeroplane described in sub-paragraphs (i)(dd) or (i)(ee) which is equipped with an approved autopilot shall not be required to carry two pilots notwithstanding that before take-off the approved autopilot is found to be unserviceable, if the aeroplane flies in accordance with arrangements approved by the Governor.
 - (iii) An aeroplane described in sub-paragraphs (i)(cc), (dd) or (ee) which is flying under and in accordance with the terms of a police air operator's certificate shall not be required to carry two pilots.
- (c) (i) Subject to sub-paragraphs (ii) and (iii), a helicopter registered in the Territory which has a maximum total weight authorised of 5,700 kg or less and a maximum approved seating configuration of nine or less which if flying for the purpose of public transport in circumstances where the aircraft commander is required to comply with the Instrument Flight Rules or which is flying by night with visual ground reference shall carry not less than two pilots as members of the flight crew thereof unless it is equipped with an autopilot with, at least, altitude hold and heading mode which is serviceable on take off.
 - (ii) A helicopter described in sub-paragraph (c)(i) which is equipped with an approved autopilot shall not be required to carry two pilots notwithstanding that before take-off the approved autopilot is found to be unserviceable, if the helicopter flies in accordance with arrangements approved by the Governor.
 - (iii) A helicopter described in sub-paragraph (c)(i) which is flying under and in accordance with the terms of a police air operator's certificate shall not be required to carry two pilots.
- (a) (4) (a) An aircraft registered in the Territory engaged on a flight for the purpose of public transport shall carry:
 - (i) a flight navigator as a member of the flight crew; or
 - (ii) navigational equipment suitable for the route to be flown;

if on the route or any diversion therefrom, being a route or diversion planned before take-off, the aircraft is intended to be more than 500 nautical miles from the point of take-off measured along the route to be flown, and to pass over part of an area specified in Schedule 7 to this Order.

(b) The flight navigator carried in compliance with this article shall be carried in addition to any person who is carried in accordance with this article to perform other duties.

(5) An aircraft registered in the Territory which is required by article 15 of this Order to be equipped with radio communications apparatus shall carry a flight radiotelephony operator as a member of the flight crew.

(6) The Governor may, in the interests of safety, direct the operator of an aircraft registered in the Territory that all or any aircraft operated by him, when flying in circumstances specified in the direction, shall carry, in addition to the flight crew required to be carried by the provisions of this article, such additional persons as members of the flight crew as he may specify in the direction.

(a) (7) (a) This paragraph applies to any flight for the purpose of public transport by an aircraft registered in the Territory:

(i) on which is carried 20 or more passengers; or

(ii) which may in accordance with its certificate of airworthiness carry more than 35 passengers and on which at least one passenger is carried.

(b) The crew of an aircraft on a flight to which this paragraph applies shall include cabin attendants carried for the purposes of performing in the interests of the safety of passengers, duties to be assigned by the operator or the commander of the aircraft but who shall not act as members of the flight crew.

(c) (i) Subject to sub-paragraph (ii), on a flight to which this paragraph applies, there shall be carried not less than one cabin attendant for every 50 or fraction of 50 passenger seats installed in the aircraft.

(ii) The number of cabin attendants calculated in accordance with sub-paragraph (i) need not be carried if the Governor has granted written permission to the operator to carry a lesser number on that flight and the operator carries the number specified in that permission and complies with any other terms and conditions subject to which such permission is granted.

(8) The Governor may, in the interests of safety, direct the operator of any aircraft registered in the Territory that all or any aircraft operated by him when flying in circumstances specified in the direction shall carry, in addition to the cabin attendants required to be carried therein by the foregoing provisions of this article, such additional persons as cabin attendants as he may specify in the direction.

Members of flight crew—requirements for licence

21.—(1) Subject to the provisions of this article, a person shall not act as a member of the flight crew of an aircraft registered in the Territory unless he is the holder of an appropriate licence granted or rendered valid under this Order.

(2) A person may within the Territory, without being the holder of such a licence:

(a) act as a flight radiotelephony operator if

(i) he does so as the pilot of a glider not flying for the purpose of public transport or aerial work and he does not communicate by radiotelephony with any air traffic control unit; or

(ii) he does so as a person being trained in an aircraft registered in the Territory to perform duties as a member of the flight crew of an aircraft; and

- (aa) he is authorised to operate the radiotelephony station by the holder of the licence granted in respect of that station under any enactment;
 - (bb) messages are transmitted only for the purposes of instruction, or of the safety or navigation of the aircraft;
 - (cc) messages are transmitted only on a frequency exceeding 60 MHz assigned by the Governor for the purposes of this sub-paragraph;
 - (dd) the operation of the transmitter requires the use only of external switches; and
 - (ee) the stability of the frequency radiated is maintained automatically by the transmitter;
- (b) subject to article 25(2) of this Order, act as pilot in command of an aircraft for the purpose of becoming qualified for the grant or renewal of a pilot's licence or the inclusion or variation of any rating in a pilot's licence if:
- (i) he is at least 16 years of age;
 - (ii) he is the holder of a valid medical certificate to the effect that he is fit so to act issued by a person approved by the Governor;
 - (iii) he complies with any conditions subject to which that medical certificate was issued;
 - (iv) no other person is carried in the aircraft;
 - (v) the aircraft is not flying for the purpose of public transport or aerial work other than aerial work which consists of the giving of instruction in flying or the conducting of flying tests; and
 - (vi) he so acts in accordance with instructions given by a person holding a pilot's licence granted under this Order, being a licence which includes a flying instructor's rating or an assistant flying instructor's rating entitling him to give instruction in flying the type of aircraft being flown;
- (c) subject to article 25(2) of this Order, act as pilot of an aircraft in respect of which the flight crew required to be carried by or under this Order does not exceed one pilot for the purpose of becoming qualified for the grant or renewal of a pilot's licence or the inclusion or variation of any rating in a pilot's licence if:
- (i) the aircraft is not flying for the purpose of public transport or aerial work other than aerial work which consists of the giving of instruction in flying or the conducting of flying tests;
 - (ii) he so acts in accordance with instructions given by a person holding a pilot's licence granted under this Order, being a licence which includes a flying instructor's rating or an assistant flying instructor's rating entitling him to give instruction in flying the type of aircraft being flown; and
 - (iii) the aircraft is fitted with dual controls and he is accompanied in the aircraft by the said instructor who is seated at the other set of controls or the aircraft is fitted with controls designed for and capable of use by two persons and he is accompanied in the aircraft by the said instructor who is seated so as to be able to use the controls;
- (d) subject to article 25 (2) of this Order, act as pilot in command of a helicopter or gyroplane at night if:
- (i) he is the holder of an appropriate licence granted or rendered valid under this Order in all respects save that the licence does not include an instrument rating and he has not within the immediately preceding 13 months carried out as pilot in command not less than 5 take-offs and 5 landings at a time when the depression of the centre of the sun was not less than 12°C below the horizon;

- (ii) he so acts in accordance with instructions given by a person holding a pilot's licence granted under this Order being a licence which includes a flying instructor's rating or an assistant flying instructor's rating entitling him to give instruction in flying the type of helicopter or gyroplane being flown by night;
 - (iii) no person other than that specified in sub-paragraph (ii) above is carried and
 - (iv) the helicopter or gyroplane is not flying for the purpose of public transport or aerial work other than aerial work which consists of the giving of instruction in flying or the conducting of flying tests;
 - (e) subject to article 25(2) of this Order, act as pilot in command of a balloon if:
 - (i) he is the holder of an appropriate licence granted or rendered valid under this Order in all respects save that he has not within the immediately preceding 13 months carried out as pilot in command 5 flights each of not less than 5 minutes duration;
 - (ii) he so acts in accordance with instructions given by a person authorised by the Governor to supervise flying in the type of balloon being flown;
 - (iii) no person other than that specified in sub-paragraph (ii) above is carried; and
 - (iv) the balloon is not flying for the purpose of public transport or aerial work other than aerial work which consists of the giving of instruction in flying or the conducting of flying tests.
- (3) Subject as aforesaid, a person shall not act as a member of the flight crew required by or under this Order to be carried in an aircraft registered in a country other than the Territory unless:
- (a) in the case of an aircraft flying for the purpose of public transport or aerial work, he is the holder of an appropriate licence granted or rendered valid under the law of the country in which the aircraft is registered or the State of the operator; or
 - (b) in the case of any other aircraft, he is the holder of an appropriate licence granted or rendered valid under the law of the country in which the aircraft is registered or under this Order, and the Governor does not in the particular case give a direction to the contrary.
- (4) For the purposes of this Part of this Order a licence granted under the law of a Contracting State other than the Territory, purporting to authorise the holder thereof to act as a member of the flight crew of an aircraft, not being a licence purporting to authorise him to act as a student pilot only, shall, unless the Governor in the particular case gives a direction to the contrary, be deemed to be a licence rendered valid under this Order but does not entitle the holder:
- (a) to act as a member of the flight crew of any aircraft flying for the purpose of public transport or aerial work or on any flight in respect of which he receives remuneration for his services as a member of the flight crew; or
 - (b) in the case of a pilot's licence, to act as pilot of any aircraft flying in controlled airspace in circumstances requiring compliance with the Instrument Flight Rules or to give any instruction in flying.
- (5) (a) Notwithstanding the provisions of paragraph (1), a person may, unless the certificate of airworthiness in force in respect of the aircraft otherwise requires, act as pilot of an aircraft registered in the Territory for the purpose of undergoing training or tests for the grant or renewal of a pilot's licence or for the inclusion, renewal or extension of a rating therein without being the holder of an appropriate licence, if the conditions specified in sub-paragraph (b) are complied with.
- (b) (i) No other person shall be carried in the aircraft or in an aircraft being towed thereby except:
 - (aa) a person carried as a member of the flight crew in compliance with this Order;

- (bb) a person authorised by the Governor to witness the aforesaid training or tests or to conduct the aforesaid tests; or
 - (cc) if the pilot in command of the aircraft is the holder of an appropriate licence, a person carried for the purpose of being trained or tested as a member of the flight crew of an aircraft.
- (ii) The person acting as the pilot of the aircraft without being the holder of an appropriate licence either:
- (aa) within the period of six months immediately preceding was serving as a qualified pilot of an aircraft in any of Her Majesty's naval, military or air forces, and his physical condition has not, so far as he is aware, so deteriorated during that period as to render him unfit for the licence for which he intends to qualify; or
 - (bb) holds a pilot's, a flight navigator's or a flight engineer's licence granted under article 22 of this Order and the purpose of the training or test is to enable him to qualify under this Order for the grant of a pilot's licence or for the inclusion of an additional type in the aircraft rating in his licence and he acts under the supervision of a person who is the holder of an appropriate licence.
- (6) Notwithstanding paragraph (1), a person may act as a member of the flight crew (otherwise than as a pilot) of an aircraft registered in the Territory for the purposes of undergoing training or tests for the grant or renewal of a flight navigator's or a flight engineer's licence or for the inclusion, renewal or extension of a rating therein, without being the holder of an appropriate licence if he acts under the supervision and in the presence of another person who is the holder of the type of licence or rating for which the person undergoing the training or tests is being trained or tested.
- (7) Notwithstanding paragraph (1), a person may act as a member of the flight crew of an aircraft registered in the Territory without being the holder of an appropriate licence if, in so doing, he is acting in the course of his duty as a member of any of Her Majesty's naval, military or air forces.
- (8) An appropriate licence for the purposes of this article means a licence which entitles the holder to perform the functions which he undertakes in relation to the aircraft concerned and the flight on which it is engaged.
- (9) This article shall not require a licence to be held by a person by reason of his acting as a member of the flight crew of a glider unless:
- (a) he acts as a flight radiotelephony operator otherwise than in accordance with paragraph (2)(a)(i); or
 - (b) the flight is for the purpose of public transport or aerial work, other than aerial work which consists of the giving of instruction in flying or the conducting of flying tests in a glider owned or operated by a flying club of which the person giving the instruction or conducting the test and the person receiving the instruction or undergoing the test are both members.
- (10) Notwithstanding anything in this article:
- (a) the holder of a licence granted or rendered valid under this Order, being a licence endorsed to the effect that the holder does not satisfy in full the relevant international standard, shall not act as a member of the flight crew of an aircraft registered in the Territory in or over the territory of a Contracting State other than the Territory except in accordance with permission granted by the competent authorities of that State.
 - (b) the holder of a licence granted or rendered valid under the law of a Contracting State other than the Territory, being a licence endorsed as aforesaid, shall not act as a member of the flight crew of any aircraft in or over the Territory except in accordance with permission

granted by the Governor, whether or not the licence is or is deemed to be rendered valid under this Order.

Grant, renewal and effect of flight crew licences

- (a) **22.** (1) (a) Subject to sub-paragraph (d), the Governor shall grant licences, subject to such conditions as he thinks fit, of any of the classes specified in Part A of Schedule 8 to this Order authorising the holder to act as a member of the flight crew of an aircraft registered in the Territory, upon his being satisfied that the applicant is a fit person to hold the licence, and is qualified by reason of his knowledge, experience, competence, skill and physical and mental fitness to act in the capacity to which the licence relates, and for that purpose the applicant shall furnish such evidence and undergo such examinations and tests (including in particular medical examinations) and undertake such courses of training as the Governor may require of him.
- (b) A licence granted under this article shall not be valid unless it bears thereon the ordinary signature of the holder in ink.
- (c) Subject to article 81 of this Order, a licence shall remain in force for the period indicated in the licence, not exceeding the period specified in respect of a licence of that class in the said Schedule, and may be renewed by the Governor from time to time upon his being satisfied that the applicant is a fit person and qualified as aforesaid. If no period is indicated in the licence it shall remain in force, subject as aforesaid, for the lifetime of the holder.
- (d) A licence of any class shall not be granted to any person who is under the minimum age specified for that class of licence in Part A of the said Schedule.
- (2) The Governor may include in a licence a rating, subject to such conditions as he thinks fit, of any of the classes specified in Part B of the said Schedule, upon his being satisfied that the applicant is qualified as aforesaid to act in the capacity to which the rating relates, and such rating shall be deemed to form part of the licence.
- (3) Subject to any conditions of the licence and to the provisions of this Order, a licence of any class shall entitle the holder to perform the functions specified in respect of that licence in Part A of the said Schedule under the heading 'Privileges' and a rating of any class shall entitle the holder of the licence in which such rating is included to perform the functions specified in respect of that rating in Part B of the said Schedule.

Maintenance of privileges of aircraft ratings in licences

- (a) **23.** (1) (a) Subject to sub-paragraphs (b) and (c), the holder of a pilot's licence or a flight engineer's licence shall not be entitled to exercise the privileges of an aircraft rating contained in the licence on a flight unless the licence bears a valid certificate of test or a valid certificate of experience in respect of the rating, which certificate shall in either case be appropriate to the functions he is to perform on that flight in accordance with Part C of Schedule 8 to this Order and shall otherwise comply with that Part.
- (b) The holder of a Private Pilot's Licence (Balloons and Airships) shall be entitled to exercise the privileges of an aircraft rating contained in the licence on a flight when the licence does not bear such a certificate.
- (c) The holder of a Private Pilot's Licence shall not be entitled to exercise the privileges of an aircraft rating contained in the licence on a flight unless the certificate of test or certificate of experience required by sub-paragraph (a) is included in the personal flying log book required to be kept by him under article 28 of this Order.
- (2) The holder of a flight navigator's licence shall not be entitled to perform functions on a flight to which article 20(4) of this Order applies unless the licence bears a valid certificate of experience

which certificate shall be appropriate to the functions he is to perform on that flight in accordance with Part C of the said Schedule and shall otherwise comply with that Part.

Maintenance of privileges of other ratings in licences

24. A person shall not be entitled to perform the functions to which an instrument rating (aeroplanes), an instrument rating (helicopters), a flying instructor's rating, an assistant flying instructor's rating, or an instrument meteorological conditions rating (aeroplanes) relates unless his licence bears a valid certificate of test, which certificate shall be appropriate to the functions to which the rating relates in accordance with Part C of Schedule 8 to this Order and shall otherwise comply with that Part.

Medical requirements for licence holders

- (a) **25.** (1) (a) The holder of a licence granted under article 22, other than a Flight Radiotelephony Operator's Licence, shall not be entitled to perform any of the functions to which his licence relates unless it includes an appropriate valid medical certificate.
- (b) Every applicant for or holder of a licence granted under article 22 shall upon such occasions as the Governor may require submit himself to medical examination by a person approved by the Governor, either generally or in a particular case or class of cases, who shall make a report to the Governor in such form as the Governor may require.
- (c) On the basis of such medical examination, the Governor or any person approved by him as competent to do so may issue a medical certificate subject to such conditions as he thinks fit to the effect that he has assessed the holder of the licence as fit to perform the functions to which the licence relates, and the certificate shall, without prejudice to paragraph (2) of this article, be valid for such period as is therein specified and shall be deemed to form part of the licence.
- (a) (2) (a) A person shall not be entitled to act as a member of the flight crew of an aircraft registered in the Territory if he knows or suspects that his physical or mental condition renders him temporarily or permanently unfit to perform such functions or to act in such capacity.
- (b) Every holder of a medical certificate issued under this article who:
- (i) suffers any personal injury involving incapacity to undertake his functions as a member of the flight crew;
 - (ii) suffers any illness involving incapacity to undertake those functions throughout a period of 21 days or more; or
 - (iii) in the case of a woman, has reason to believe that she is pregnant;

shall inform the Governor in writing of such injury, illness or pregnancy, as soon as possible in the case of injury or pregnancy, and as soon as the period of 21 days has expired in the case of illness. The medical certificate shall be deemed to be suspended upon the occurrence of such injury or the expiry of such period of illness or the confirmation of the pregnancy, and

- (aa) in the case of injury or illness the suspension shall cease upon the holder being medically examined under arrangements made by the Governor and pronounced fit to resume his functions as a member of the flight crew or upon the Governor exempting, subject to such conditions as he thinks fit, the holder from the requirement of a medical examination; and
- (bb) in the case of pregnancy, the suspension may be lifted by the Governor for such period and subject to such conditions as he thinks fit and shall cease upon the holder being medically examined under arrangements made by the Governor after

the pregnancy has ended and pronounced fit to resume her functions as a member of the flight crew.

Miscellaneous licensing provisions

26.—(1) A person who, on the last occasion when he took a test for the purposes of articles 23 or 24, failed that test shall not be entitled to fly in the capacity for which that test would have qualified him had he passed it.

(2) Nothing in this Order shall prohibit the holder of a pilot's licence from acting as pilot of an aircraft certificated for single pilot operation when, with the permission of the Governor he is testing any person for the purposes of articles 22(1), 22(2), 23 or 24, notwithstanding that the type of aircraft in which the test is conducted is not specified in an aircraft rating included in his licence or that the licence or personal flying log book, as the case may be, does not include a valid certificate of test, experience or revalidation in respect of the type of aircraft.

(3) Where any provision of Part C of Schedule 8 or Part B of Schedule 10 to this Order permits a test to be conducted in a flight simulator approved by the Governor, that approval may be granted subject to such conditions as the Governor thinks fit.

(4) Without prejudice to any other provision of this Order the Governor may, for the purpose of this Part of this Order, either absolutely or subject to such conditions as he thinks fit:

- (a) approve any course of training or instruction;
- (b) authorise a person to conduct such examinations or tests as he may specify; and
- (c) approve a person to provide any course of training or instruction.

Validation of Licences

27. The Governor may issue a certificate of validation rendering valid for the purpose of this Order any flight crew licence granted under the law of any country other than the Territory. A certificate of validation may be issued subject to such conditions and for such periods as the Governor thinks fit.

Personal flying log book

28.—(1) Every member of the flight crew of an aircraft registered in the Territory and every person who engages in flying for the purpose of qualifying for the grant or renewal of a licence under this Order shall keep a personal flying log book in which the following particulars shall be recorded:

- (a) the name and address of the holder of the log book;
- (b) particulars of the holder's licence (if any) to act as a member of the flight crew of an aircraft; and
- (c) the name and address of his employer (if any).

(2) Particulars of each flight during which the holder of the log book acted either as a member of the flight crew of an aircraft or for the purpose of qualifying for the grant or renewal of a licence under this Order, as the case may be, shall be recorded in the log book at the end of each flight or as soon thereafter as is reasonably practicable, including:

- (a) the date, the places at which the holder embarked on and disembarked from the aircraft and the time spent during the course of a flight when he was acting in either capacity;
- (b) the type and registration marks of the aircraft;
- (c) the capacity in which the holder acted in flight;
- (d) particulars of any special condition under which the flight was conducted, including night flying and instrument flying; and

(e) particulars of any test or examination undertaken whilst in flight.

(3) For the purposes of this article, a helicopter shall be deemed to be in flight from the moment the helicopter first moves under its own power for the purpose of taking off until the rotors are next stopped.

(4) Particulars of any test or examination undertaken whilst in a flight simulator shall be recorded in the log book, including:

- (a) the date of the test or examination;
- (b) the type of simulator;
- (c) the capacity in which the holder acted; and
- (d) the nature of the test or examination.

Instruction in flying

29.—(1) A person shall not give any instruction in flying to which this article applies unless:

- (a) he holds a licence, granted or rendered valid under this Order entitling him to act as pilot in command of the aircraft for the purpose and in the circumstances under which the instruction is to be given; and
- (b) his licence includes an instructor's rating or an assistant flying instructor's rating entitling the holder to give the instruction.

(2) Subject to paragraph (3), this article applies to instruction in flying given to any person flying or about to fly a flying machine or glider for the purpose of becoming qualified for:

- (a) the grant of a pilot's licence; and
- (b) the inclusion or variation of any rating in his licence.

(3) This article shall not apply to any instruction in flying given to a person for the purpose of becoming qualified for the inclusion in his licence of an aircraft rating entitling him to act as pilot of a multi-engined aircraft, or an aircraft of any class appearing in column 4 of the Table in Part A of Schedule 2 to this Order, if that person has previously been entitled under this Order or qualified in any of Her Majesty's naval, military or air forces, to act as pilot of multi-engined aircraft or an aircraft of that class, as the case may be.

Glider pilot-minimum age

30. A person under the age of 16 years shall not act as pilot in command of a glider.

PART V

Operation of Aircraft

Operations manual

- (a) **31.** (1) (a) Subject to sub-paragraph (b), this article shall apply to public transport aircraft registered in the Territory except aircraft used for the time being solely for flights not intended to exceed 60 minutes in duration, which are either:
 - (i) flights solely for training persons to perform duties in an aircraft; or
 - (ii) flights intended to begin and end at the same aerodrome.
- (b) This article shall not apply to an aircraft flying or intended by the operator of the aircraft to fly solely under and in accordance with the terms of a police air operator's certificate.

- (a) (2) (a) The operator of every aircraft to which this article applies shall:
 - (i) make available to each member of his operating staff an operations manual;
 - (ii) ensure that each copy of the operations manual is kept up to date; and
 - (iii) ensure that on each flight every member of the crew has access to a copy of every part of the operations manual which is relevant to his duties on the flight.
- (b) (i) Subject to sub-paragraph (ii), each operations manual shall contain all such information and instructions as may be necessary to enable the operating staff to perform their duties as such including in particular information and instructions relating to the matters specified in Part A of Schedule 10 to this Order.
- (b) (ii) The operations manual shall not be required to contain any information or instructions available in a flight manual accessible to the persons by whom the information or instructions may be required.
- (a) (3) (a) An aircraft to which this article applies shall not fly unless, not less than 30 days prior to such flight, the operator of the aircraft has furnished to the Governor a copy of the whole of the operations manual for the time being in effect in respect of the aircraft.
- (b) Subject to sub-paragraph (c), any amendments or additions to the operations manual shall be furnished to the Governor by the operator before or immediately after they come into effect.
- (c) Where an amendment or addition relates to the operation of an aircraft to which the operations manual did not previously relate, that aircraft shall not fly for the purpose of public transport until the amendment or addition has been furnished to the Governor.
- (d) Without prejudice to the foregoing sub-paragraphs, the operator shall make such amendments or additions to the operations manual as the Governor may require for the purpose of ensuring the safety of the aircraft or of persons or property carried therein or the safety, efficiency or regularity of air navigation.

(4) For the purposes of this article, article 32, article 58 of and Schedule 10 to this Order, “operating staff” means the servants and agents employed by the operator, whether or not as members of the crew of the aircraft, to ensure that the flights of the aircraft are conducted in a safe manner, and includes an operator who himself performs those functions.

(5) If in the course of a flight on which the equipment specified in Scale O in paragraph 5 of Schedule 4 hereto is required to be provided the said equipment becomes unserviceable, the aircraft shall be operated on the remainder of that flight in accordance with any relevant instructions in the operations manual.

Police operations manual

32.—(1) This article shall apply to aircraft flying, or intended by the operator, of the aircraft to fly, under and in accordance with the terms of a police air operator’s certificate.

(2) An aircraft to which this article applies shall not fly except under and in accordance with the terms of Part I and Part II of a police operations manual, Part I of which shall have been approved in respect of the aircraft by the Governor.

- (a) (3) (a) The operator of every aircraft to which this article applies shall:
 - (i) make available to each member of its operating staff a police operations manual;
 - (ii) ensure that each copy of the operations manual is kept up to date; and
 - (iii) ensure that on each flight every member of the crew has access to a copy of every part of the operations manual which is relevant to his duties on the flight.

- (b) Each police operations manual shall contain all such information and instructions as may be necessary to enable the operating staff to perform their duties as such.
- (4) The Governor may approve Part I of the police operations manual for the purposes of this article either absolutely or subject to such conditions as he thinks fit.
 - (a) (5) (a) An aircraft to which this article applies shall not fly unless, not less than 30 days prior to such flight, the operator of the aircraft has furnished to the Governor a copy of Part II of the police operations manual for the time being in effect in respect of the aircraft.
 - (b) Subject to sub-paragraph (c), any amendments or additions to Part II of the police operations manual shall be furnished to the Governor by the operator before or immediately after they come into effect.
 - (c) Where an amendment or addition relates to the operation of an aircraft to which the police operations manual did not previously relate, that aircraft shall not fly in the service of the police authority under and in accordance with the terms of a police operator's certificate until the amendment or addition has been furnished to the Governor.
- (6) Without prejudice to the foregoing paragraphs, the operator shall make such amendments or additions to the police operations manual as the Governor may require for the purpose of ensuring the safety of the aircraft, or of persons or property carried therein, or the safety, efficiency or regularity of air navigation.
- (7) For the purposes of this article "operating staff" has the meaning ascribed to it in article 31(4) of this Order.

Training manual

- 33.—**(1) Subject to paragraph (2), the operator of every aircraft registered in the Territory and flying for the purpose of public transport shall:
- (a) make a training manual available to every person appointed by the operator to give or to supervise the training, experience, practice or periodical tests required under article 34(3) of this Order; and
 - (b) ensure that each copy of that training manual is kept up to date.
- (2) This article shall not apply to aircraft flying, or intended by the operator of the aircraft to fly, solely under and in accordance with the terms of a police air operator's certificate.
- (3) Each training manual shall contain all such information and instructions as may be necessary to enable a person appointed by the operator to give or to supervise the training, experience, practice and periodical tests required under article 34(3) of this Order to perform his duties as such including in particular information and instruction relating to the matters specified in Part C of Schedule 10 to this Order.
- (a) (4) (a) An aircraft to which this article applies shall not fly unless not less than 30 days prior to such flight the operator of the aircraft has furnished to the Governor a copy of the whole of his training manual relating to the crew of that aircraft.
 - (b) Subject to sub-paragraph (c), any amendments or additions to the training manual shall be furnished to the Governor by the operator before or immediately after they come into effect.
 - (c) Where an amendment or addition relates to training, experience, practice or periodical tests on an aircraft to which the training manual did not previously relate, that aircraft shall not fly for the purpose of public transport until the amendment or addition has been furnished to the Governor.
 - (d) Without prejudice to the foregoing sub-paragraphs, the operator shall make such amendments or additions to the training manual as the Governor may require for the

purpose of ensuring the safety of the aircraft, or of persons or property carried therein, or the safety, efficiency or regularity of air navigation.

Public transport-operator's responsibilities

34.—(1) The operator of an aircraft registered in the Territory shall not permit the aircraft to fly for the purpose of public transport without first:

- (a) designating from among the flight crew a pilot to be the commander of the aircraft for the flight;
- (b) satisfying himself by every reasonable means that the aeronautical radio stations and navigational aids serving the intended route or any planned diversion therefrom are adequate for the safe navigation of the aircraft; and
- (c) subject to sub-paragraph (2) hereof, satisfying himself by every reasonable means that every place (whether or not an aerodrome) at which it is intended to take off or land and any alternate place (whether or not an aerodrome) at which a landing may be made are suitable for the purpose and in particular that they will be adequately manned and equipped at the time at which it is reasonably estimated such a take-off or landing will be made (including such manning and equipment as is specified in regulation 16 in Schedule 14 to this Order) to ensure so far as practicable the safety of the aircraft and its passengers.

(2) Without prejudice to any conditions imposed pursuant to article 6 of this Order, the operator of an aircraft shall not be required for the purposes of this article to satisfy himself as to the adequacy of fire-fighting, search, rescue or other services which are required only after the occurrence of an accident.

(3) The operator of an aircraft registered in the Territory shall not permit any person to be a member of the crew thereof during any flight for the purpose of public transport (except a flight for the sole purpose of training persons to perform duties in aircraft) unless:

- (a) such person has had the training, experience, practice and periodical tests specified in Part B of Schedule 10 to this Order in respect of the duties which he is to perform; and
- (b) the operator has satisfied himself that such person is competent to perform his duties, and in particular to use the equipment provided in the aircraft for that purpose.

(4) The operator shall maintain, preserve, produce and furnish information respecting records relating to the matters specified in paragraph (3) in accordance with Part B of the said Schedule 10.

(5) The operator of an aircraft registered in the Territory shall not permit any member of the flight crew thereof, during any flight for the purpose of the public transport of passengers, to simulate emergency manoeuvres and procedures which the operator has reason to believe will adversely affect the flight characteristics of the aircraft.

Loading-public transport aircraft and suspended loads

35.—(1) The operator of an aircraft registered in the Territory shall not cause or permit it to be loaded for a flight for the purpose of public transport, or any load to be suspended therefrom, except under the supervision of a person whom he has caused to be furnished with written instructions as to the distribution and securing of the load so as to ensure that:

- (a) the load may safely be carried on the flight; and
- (b) any conditions subject to which the certificate of airworthiness in force in respect of the aircraft was issued or rendered valid, being conditions relating to the loading of the aircraft, are complied with.

- (a) (2) (a) Subject to sub-paragraph (b), the instruction shall indicate the weight of the aircraft prepared for service, that is to say the aggregate of the weight of the aircraft

(shown in the weight schedule referred to in article 18 of this Order) and the weight of such additional items in or on the aircraft as the operator thinks fit to include; and the instructions shall indicate the additional items included in the weight of the aircraft prepared for service, and show the position of the centre of gravity of the aircraft at that weight.

- (b) Sub-paragraph (a) shall not apply in relation to a flight if:
- (i) the aircraft's maximum total weight authorised does not exceed 1150 kg;
 - (ii) the aircraft's maximum total weight authorised does not exceed 2730 kg and the flight is intended not to exceed 60 minutes in duration and is either:
 - (aa) a flight solely for training persons to perform duties in an aircraft; or
 - (bb) a flight intended to begin and end at the same aerodrome; or
 - (iii) the aircraft is a helicopter the maximum total weight authorised of which does not exceed 3000 kg, and the total seating capacity of which does not exceed five persons.
- (3) The operator of an aircraft shall not cause or permit it to be loaded in contravention of the instructions referred to in paragraph (1).
- (a) (4) (a) Subject to sub-paragraph (b), the person supervising the loading of the aircraft shall, before the commencement of any such flight, prepare and sign a load sheet in duplicate conforming to the requirements specified in regulation 2 in Schedule 14 to this Order, and shall (unless he is himself the commander of the aircraft) submit the load sheet for examination by the commander of the aircraft who shall sign his name thereon.
- (b) The requirements of sub-paragraph (a) shall not apply if:
- (i) the load and the distributing and securing thereof upon the next intended flight are to be unchanged from the previous flight and the commander of the aircraft makes and signs an endorsement to that effect upon the load sheet for the previous flight, indicating the date of the endorsement, the place of departure upon the next intended flight and the next intended place of destination; or
 - (ii) paragraph (2)(a) does not apply in relation to the flight.
- (a) (5) (a) Subject to sub-paragraph (b), one copy of the load sheet shall be carried in the aircraft when article 76 of this Order so requires until the flights to which it relates have been completed and one copy of that load sheet and of the instructions referred to in this article shall be preserved by the operator until the expiration of a period of six months thereafter and shall not be carried in the aircraft.
- (b) In the case of an aeroplane of which the maximum total weight authorised does not exceed 2730 kg, or a helicopter, if it is not reasonably practicable for the copy of the load sheet to be kept on the ground it may be carried in the aeroplane or helicopter, as the case may be, in a container approved by the Governor for that purpose.
- (6) The operator of an aircraft registered in the Territory and flying for the purpose of the public transport of passengers shall not cause or permit baggage to be carried in the passenger compartment of the aircraft unless such baggage can be properly secured and, in the case of an aircraft capable of seating more than 30 passengers, such baggage (other than baggage carried in accordance with a permission issued pursuant to article 45(2)(d) of this Order) shall not exceed the capacity of the spaces in the passenger compartment approved by the Governor for the purpose of stowing baggage.

Public transport-operating conditions

36.—(1) An aircraft registered in the Territory shall not fly for the purpose of public transport, except for the sole purpose of training persons to perform duties in aircraft unless the relevant requirements specified in regulations 3 to 13 inclusive in Schedule 14 to this Order in respect of

its weight and related performance and flight in specified meteorological conditions or at night are complied with.

- (a) (2) (a) The assessment of the ability of an aircraft to comply with paragraph (1) shall be based on the information as to its performance contained in the certificate of airworthiness relating to the aircraft.
- (b) In the event of the information given therein being insufficient for that purpose such assessment shall be based on the best information available to the commander of the aircraft.

(3) A flying machine registered in the Territory when flying over water for the purpose of public transport shall fly, except as may be necessary for the purpose of take-off or landing, at such an altitude as would enable the aircraft:

- (a) if it has one engine only, in the event of the failure of that engine; or
- (b) if it has more than one engine, in the event of the failure of one of those engines and with the remaining engine or engines operating within the maximum continuous power conditions specified in the certificate of airworthiness relating to the aircraft;

to reach a place at which it can safely land at a height sufficient to enable it to do so.

- (a) (4) (a) Without prejudice to paragraph (3), an aeroplane in respect of which there is in force under this Order a certificate of airworthiness designating the aeroplane as being of performance group X shall not fly over water for the purpose of public transport so as to be more than 60 minutes flying time from the nearest shore, unless the aeroplane has more than 2 power units.
- (b) For the purposes of this paragraph, flying time shall be calculated at normal cruising speed with one power unit inoperative.

- (a) (5) (a) Without prejudice to paragraph (3), a helicopter in respect of which there is in force under this Order a certificate of airworthiness designating the helicopter as being of performance group B (in this paragraph call 'a group B helicopter') shall not fly over water for the purpose of public transport so as to be more than 20 seconds flying time from a point from which it can make an autorotative descent to land suitable for an emergency landing (in this paragraph called 'the specified circumstances') unless it is equipped with apparatus approved by the Governor enabling it to land safely on water (in this paragraph called "the required apparatus").

- (b) Without prejudice to paragraph (3), a group B helicopter equipped with the required apparatus, which is flying under and in accordance with the terms of an air operator's certificate but not under and in accordance with the terms of a police air operator's certificate, shall not fly in the specified circumstances on any flight for more than three minutes except with the permission in writing of the Governor and in accordance with any conditions subject to which that permission may have been granted.

- (c) Without prejudice to paragraph (3), a group B helicopter equipped with the required apparatus which is flying under and in accordance with the terms of a police air operator's certificate on which is carried any passenger who is not a permitted passenger, shall not fly in the specified circumstances on any flight for more than 20 minutes.

- (d) Without prejudice to paragraph (3), a group B helicopter equipped with the required apparatus which is flying under and in accordance with the terms of a police air operator's certificate on which no passenger is carried other than a permitted passenger, shall not fly over water on any flight for more than 10 minutes so as to be more than 5 minutes from a point from which it can make an autorotative descent to land suitable for an emergency landing.

- (e) For the purposes of this paragraph flying time shall be calculated on the assumption that a helicopter is flying in still air at the speed specified in the certificate of airworthiness in force in respect of the helicopter as the speed for compliance with regulations governing flights over water.
- (a) (6) (a) Without prejudice to paragraph (3), a helicopter in respect of which there is in force under this Order a certificate of airworthiness designating the helicopter as being of performance group A2 (in this paragraph called ‘a group A2 helicopter’), which is flying under and in accordance with the terms of an air operator’s certificate but not under and in accordance with the terms of a police air operator’s certificate, shall not fly over water for the purpose of public transport for more than 15 minutes during any flight unless it is equipped with apparatus approved by the Governor enabling it to land safely on water (in this paragraph called “the required apparatus”).
- (b) Without prejudice to paragraph (3), a group A2 helicopter not equipped with the required apparatus which is flying under and in accordance with the terms of a police air operator’s certificate on which any passenger is carried who is not a permitted passenger shall not fly over any water on any flight for more than 15 minutes.
- (7) Notwithstanding the provisions of paragraph (1), a helicopter in respect of which there is in force under this Order a certificate of airworthiness designating the helicopter as being of performance group A or performance group A (Restricted) may fly for the purpose of public transport in accordance with the weight and related performance requirements prescribed for helicopters designated as being of:
- (a) performance group A (Restricted) in the case of a helicopter designated as being of performance group A if:
- (i) the maximum total weight authorised of the helicopter is less than 5700 kg; and
 - (ii) the total number of passengers carried on the helicopter does not exceed 15; or
- (b) performance group B if:
- (i) the maximum total weight authorised of the helicopter is less than 2730 kg; and
 - (ii) the total number of passengers carried does not exceed 9.
- (8) For the purposes of this article a “permitted passenger” means:
- (a) a police officer;
 - (b) an employee of the police authority;
 - (c) a medical attendant;
 - (d) the holder of a valid pilot’s licence who intends to act as a member of the flight crew of an aircraft flying under and in accordance with the terms of a police air operator’s certificate and who is being carried for the purpose of training or familiarisation; or
 - (e) such other person being carried for purposes connected with police operations as may be permitted in writing by the Governor.

Public transport operations at night or in instrument meteorological conditions by single engined aeroplanes not registered in the Territory

37. An aeroplane which is not registered in the Territory and is powered by one engine only shall not fly for the purpose of public transport at night or when the cloud ceiling or visibility prevailing at the aerodrome of departure and forecast for the estimated time of landing at the aerodrome at which it is intended to land and at any alternate aerodrome are less than 1,000 feet and 1 nautical mile respectively.

Public transport aircraft registered in the Territory— aerodrome operating minima

38.—(1) This article shall apply to public transport aircraft registered in the Territory.

(a) (2) (a) Subject to sub-paragraph (b), the operator of every aircraft to which this article applies shall establish and include in the operations manual or the police operations manual relating to the aircraft the particulars (in this sub-paragraph called “the said particulars”) of the aerodrome operating minima appropriate to every aerodrome of intended departure or landing and every alternate aerodrome.

(b) in relation to any flight wherein:

(i) neither an operations manual nor a police operations manual is required pursuant to article 31(2)(a) or 32(3)(a) respectively of this Order; or

(ii) it is not practicable to include the said particulars in the operations manual or the police operations manual;

the operator of the said aircraft shall, prior to the commencement of the flight, cause to be furnished in writing to the commander of the aircraft the said particulars calculated in accordance with the required data and instructions (as defined in sub-paragraph (c)(i)) and the operator shall cause a copy of the said particulars to be retained outside the aircraft for a minimum period of three months.

(c) (i) The operator of every aircraft to which this article applies for which an operations manual or a police operations manual is required pursuant to article 31(2)(a) or 32(3)(a) respectively of this Order, shall include in that operations manual such data and instructions (in this article called “the required data and instructions”) as will enable the commander of the aircraft to calculate the aerodrome operating minima appropriate to aerodromes the use of which cannot reasonably have been foreseen by the operator prior to the commencement of the flight.

(ii) The operator of every such aircraft to which this article applies for which neither an operations manual nor a police operations manual is required pursuant to article 31(2)(a) or 32(3)(a) respectively of this Order shall, prior to the commencement of the flight, cause to be furnished in writing to the commander of the aircraft the required data and instructions, and the operator shall cause a copy of the required data and instructions to be retained outside the aircraft for a minimum period of three months.

(3) The specified aerodrome operating minima shall not permit a landing or take-off in circumstances where the relevant aerodrome operating minima declared by the competent authority would prohibit it, unless that authority otherwise permits in writing.

(4) In establishing aerodrome operating minima for the purposes of this article the operator of the aircraft shall take into account the following matters:

(a) the type and performance and handling characteristics of the aircraft and any relevant conditions in its certificate of airworthiness;

(b) the composition of its crew;

(c) the physical characteristics of the relevant aerodrome and its surroundings;

(d) the dimensions of the runways which may be selected for use; and

(e) whether or not there are in use at the relevant aerodrome any aids, visual or otherwise, to assist aircraft in approach, landing or take-off, being aids which the crew of the aircraft are trained and equipped to use; the nature of any such aids that are in use; and the procedures for approach, landing and take-off which may be adopted according to the existence or absence of such aids;

and shall establish in relation to each runway which may be selected for use such aerodrome operating minima as are appropriate to each set of circumstances which can reasonably be expected.

- (5) An aircraft to which this article applies shall not commence a flight at a time when:
- (a) the cloud ceiling or the runway visual range at the aerodrome of departure is less than the relevant minimum specified for take-off; or
 - (b) according to the information available to the commander of the aircraft it would not be able, without contravening paragraphs (6) or (7), to land at the aerodrome of intended destination at the estimated time of arrival there and at any alternate aerodrome at any time at which according to a reasonable estimate the aircraft would arrive there.
- (6) An aircraft to which article 31 of this Order applies, when making a descent to an aerodrome, shall not descend from a height of 1000 ft or more above the aerodrome to a height less than 1000 ft above the aerodrome if the relevant runway visual range at the aerodrome is at the time less than the specified minimum for landing.
- (7) An aircraft to which this article applies, when making a descent to an aerodrome, shall not:
- (a) continue an approach to landing at any aerodrome by flying below the relevant specified decision height; or
 - (b) descend below the relevant specified minimum descent height;

unless in either case from such height the specified visual reference for landing is established and is maintained.

(8) If, according to the information available, an aircraft would as regards any flight be required by the Rules of the Air to be flown in accordance with the Instrument Flight Rules at the aerodrome of intended landing, the commander of the aircraft shall select prior to take-off an alternate aerodrome unless no aerodrome suitable for that purpose is available.

(9) In this article “specified” in relation to aerodrome operating minima means such particulars of aerodrome operating minima as have been specified by the operator in, or are ascertainable by reference to, the operations manual relating to that aircraft, or furnished in writing to the commander of the aircraft by the operator pursuant to sub-paragraphs (2)(b) or (2)(c)(ii).

Public transport aircraft not registered in the Territory—aerodrome operating minima

39.—(1) This article shall apply to public transport aircraft registered in a country other than the Territory.

(2) An aircraft to which this article applies shall not fly in or over the Territory unless the operator thereof has made available to the flight crew aerodrome operating minima which comply with paragraph (3) in respect of every aerodrome at which it is intended to land or take off and every alternate aerodrome.

(3) The aerodrome operating minima provided in accordance with paragraph (2) shall be no less restrictive than either:

- (a) minima calculated in accordance with the notified method for calculating aerodrome operating minima; or
- (b) minima which comply with the law of the country in which the aircraft is registered,

whichever, are the more restrictive.

- (a) (4) (a) An aircraft to which this article applies shall not:
 - (i) conduct a Category II, Category IIIA or Category IIIB approach and landing; or
 - (ii) takeoff when the relevant runway visual range is less than 150 metres, otherwise than under and in accordance with the terms of an approval granted by the Governor.

- (b) An approval granted pursuant to sub-paragraph (a) shall be in writing and may be granted subject to such conditions as the Governor thinks fit.
- (5) An aircraft to which this article applies shall not take off or land at an aerodrome in the Territory in contravention of the specified aerodrome operating minima.
- (6) Without prejudice to the provisions of paragraphs (4) and (5), an aircraft to which this article applies, when making a descent to an aerodrome, shall not descend from a height of 1000 feet or more above the aerodrome to a height of less than 1000 feet above the aerodrome if the relevant runway visual range at the aerodrome is at the time less than the specified minimum for landing.
- (7) Without prejudice to the provisions of paragraphs (4) and (5), an aircraft to which this article applies, when making a descent to an aerodrome, shall not:
 - (a) continue an approach to landing at any aerodrome by flying below the relevant specified decision height; or
 - (b) descend below the relevant specified minimum descent height, unless in either case from such height the specified visual reference for landing is established and is maintained.
- (8) In this article:
 - (a) “specified” means specified by the operator in the aerodrome operating minima made available to the flight crew pursuant to paragraph (2);
 - (b) “a Category II approach and landing” means a landing following a precision approach using an Instrument Landing System or Microwave Landing System with:
 - (i) a decision height lower than 200 feet but not less than 100 feet; and
 - (ii) a runway visual range of not less than 300 metres;
 - (c) “a Category IIIA approach and landing” means landing following a precision approach using an Instrument Landing System or Microwave Landing System with:
 - (i) a decision height lower than 100 feet; and
 - (ii) a runway visual range of not less than 200 metres; and
 - (d) “a Category IIIB approach and landing” means a landing following a precision approach using an Instrument Landing System or Microwave Landing System with:
 - (i) a decision height lower than 50 feet or no decision height; and
 - (ii) a runway visual range less than 200 metre but not less than 75 metres.

Non-public transport aircraft—aerodrome operating minima

- 40.**—(1) This article shall apply to any aircraft which is not a public transport aircraft.
- (2) An aircraft to which this article applies when making a descent at an aerodrome to a runway in respect of which there is a notified instrument approach procedure shall not descend from a height of 1000 ft or more above the aerodrome to a height less than 1000 ft above the aerodrome if the relevant runway visual range for that runway is at the time less than the specified minimum for landing.
- (3) An aircraft to which this article applies when making a descent to a runway in respect of which there is a notified instrument approach procedure shall not:
 - (a) continue an approach to landing on such a runway by flying below the relevant specified decision height; or
 - (b) descend below the relevant specified minimum descent height;unless in either case from such height the specified visual reference for landing is established and is maintained.
- (4) In this article “specified” in relation to aerodrome operating minima means such particulars of aerodrome operating minima as have been notified in respect of the aerodrome or if the relevant

minima have not been notified such minima as are ascertainable by reference to the notified method for calculating aerodrome operating minima.

Pilots to remain at controls

- (a) **41.** (1) (a) The commander of a flying machine or glider registered in the Territory shall cause one pilot to remain at the controls at all times while it is in flight.
 - (b) If the flying machine or glider is required by or under this Order to carry two pilots, the commander shall cause both pilots to remain at the controls during take-off and landing.
 - (c) If the flying machine or glider carries two or more pilots (whether or not it is required to do so) and is engaged on a flight for the purpose of the public transport of passengers, the commander shall remain at the controls during take-off and landing.
- (2) Each pilot at the controls shall be secured in his seat by either a safety belt with or without one diagonal shoulder strap, or a safety harness except that during take-off and landing a safety harness shall be worn if it is required by article 14 of this Order to be provided.

Wearing of survival suits by crew

42.—(1) Subject to paragraph (2), each member of the crew of an aircraft registered in the Territory shall wear a survival suit if such a suit is required by article 14 of this Order to be carried.

(2) This article shall not apply to any member of the crew of such an aircraft flying under and in accordance with the terms of a police air operator's certificate.

Pre-flight action by commander of aircraft

43. The commander of an aircraft registered in the Territory shall reasonably satisfy himself before the aircraft takes off:

- (a) that the flight can safely be made, taking into account the latest information available as to the route and aerodrome to be used, the weather reports and forecasts available and any alternative course of action which can be adopted in case the flight cannot be completed as planned;
- (b) (i) that the equipment (including radio apparatus) required by or under this Order to be carried in the circumstances of the intended flight is carried and is in a fit condition for use; or
(ii) that the flight may commence under and in accordance with the terms of a permission granted to the operator pursuant to article 16 of this Order;
- (c) that the aircraft is in every way fit for the intended flight, and that where a certificate of maintenance review is required by article 10(1) of this Order to be in force, it is in force and will not cease to be in force during the intended flight;
- (d) that the load carried by the aircraft is of such weight, and is so distributed and secured, that it may safely be carried on the intended flight;
- (e) in the case of a flying machine or airship, that sufficient fuel, oil and engine coolant (if required) are carried for the intended flight, and that a safe margin has been allowed for contingencies, and, in the case of a flight for the purpose of public transport, that the instructions in the operations manual relating to fuel, oil and engine coolant have been complied with;
- (f) in the case of an airship or balloon, that sufficient ballast is carried for the intended flight;
- (g) in the case of a flying machine, that having regard to the performance of the flying machine in the conditions to be expected on the intended flight, and to any obstructions at the places

of departure and intended destination and on the intended route, it is capable of safely taking off, reaching and maintaining a safe height thereafter and making a safe landing at the place of intended destination; and

- (h) that any pre-flight check system established by the operator and set forth in the operations manual or elsewhere has been complied with by each member of the crew of the aircraft.

Passenger briefing by commander

44.—(1) Subject to paragraph (2), the commander of an aircraft registered in the Territory shall take all reasonable steps to ensure:

- (a) before the aircraft takes off on any flight, that all passengers are made familiar with the position and method of use of emergency exits, safety belts (with diagonal shoulder strap where required to be carried), safety harnesses and (where required to be carried) oxygen equipment, lifejackets and the floor path lighting system and all other devices required by or under this Order and intended for use by passengers individually in the case of an emergency occurring to the aircraft; and
- (b) that in an emergency during a flight, all passengers are instructed in the emergency action which they should take.

(2) This article shall not apply to the commander of an aircraft registered in the Territory in relation to a flight under and in accordance with the terms of a police air operator's certificate.

Public transport of passengers—additional duties of commander

45.—(1) This article applies to flights for the purpose of the public transport of passengers by aircraft registered in the Territory other than flights under and in accordance with the terms of a police air operator's certificate.

(2) In relation to every flight to which this article applies the commander of the aircraft shall:

- (a) (i) subject to sub-paragraph (iii), if the aircraft is not a seaplane but is intended in the course of the flight to reach a point more than 30 minutes flying time (while flying in still air at the speed specified in the relevant certificate of airworthiness as the speed for compliance with regulations governing flights over water) from the nearest land, take all reasonable steps to ensure that before take-off all passengers are given a demonstration of the method of use of the lifejackets required by or under this Order for the use of passengers;
- (ii) subject to sub-paragraph (iii), if the aircraft is not a seaplane but is required by article 20(7) of this Order to carry cabin attendants, take all reasonable steps to ensure that, before the aircraft takes off on a flight:
 - (aa) which is intended to proceed beyond gliding distance from land; or
 - (bb) on which in the event of any emergency occurring during the take-off or during the landing at the intended destination or any likely alternate destination it is reasonably possible that the aircraft would be forced to land onto water;

all passengers are given a demonstration of the method of use of the lifejackets required by or under this Order for the use of passengers;

- (iii) where the only requirement to give such a demonstration arises because it is reasonably possible that the aircraft would be forced to land onto water at one or more of the likely alternate destinations the demonstration need not be given until after the decision has been taken to divert to such a destination;

- (b) if the aircraft is a seaplane, take all reasonable steps to ensure that before the aircraft takes off all passengers are given a demonstration of the method of use of the equipment referred to in the preceding sub-paragraph;
- (c) before the aircraft takes off, and before it lands, take all reasonable steps to ensure that the crew of the aircraft are properly secured in their seats and that any persons carried in compliance with article 20(7) of this Order are properly secured in seats which shall be in a passenger compartment and which shall be so situated that those persons can readily assist passengers;
- (d) from the moment when, after the embarkation of its passengers for the purpose of taking off, it first moves until after it has taken off, and before it lands until it comes to rest for the purpose of the disembarkation of its passengers, and whenever by reason of turbulent air or any emergency occurring during the flight he considers the precaution necessary:
 - (i) take all reasonable steps to ensure that all passengers of 2 years of age or more are properly secured in their seats by safety belts (with diagonal shoulder strap, where required to be carried) or safety harnesses and that all passengers under the age of 2 years are properly secured by means of a child restraint device; and
 - (ii) take all reasonable steps to ensure that those items of baggage in the passenger compartment which he reasonably considers ought by virtue of their size, weight or nature to be properly secured are properly secured and, in the case of an aircraft capable of seating more than 30 passengers, that such baggage is either stowed in the passenger compartment stowage spaces approved by the Governor for the purpose or carried in accordance with the terms of a written permission granted by the Governor which permission may be granted subject to such conditions as the Governor thinks fit;
- (e) in the case of aircraft in respect of which a certificate of airworthiness was first issued (whether in the Territory or elsewhere) on or after 1st January 1989 except in a case where a pressure greater than 700 hectopascals is maintained in all passenger and crew compartments throughout the flight, take all reasonable steps to ensure that:
 - (i) before the aircraft reaches flight level 100 the method of use of the oxygen provided in the aircraft in compliance with the requirements of article 14 of this Order is demonstrated to all passengers;
 - (ii) when flying above flight level 120 all passengers and cabin attendants are recommended to use oxygen; and
 - (iii) during any period when the aircraft is flying above flight level 100 oxygen is used by all the flight crew of the aircraft.
- (f) in the case of aircraft in respect of which a certificate of airworthiness was first issued (whether in the Territory or elsewhere) prior to 1st January 1989, except in the case where a pressure greater than 700 hectopascals is maintained in all passenger and crew compartments throughout the flight, take all reasonable steps to ensure that:
 - (i) (aa) before the aircraft reaches flight level 130 of the method of use of the oxygen provided in the aircraft in compliance with the requirements of article 14 of this Order is demonstrated to all passengers;
 - (bb) when flying above flight level 130 all passengers and cabin attendants are recommended to use oxygen; and
 - (cc) during any period when the aircraft is flying above flight level 100 oxygen is used by all the flight crew of the aircraft; or
 - (ii) he complies instead with the provisions of sub-paragraph (e).

Operation of radio in aircraft

46.—(1) The radio station in an aircraft shall not be operated, whether or not the aircraft is in flight, except in accordance with the conditions of the licence issued in respect of that station under the law of the country in which the aircraft is registered or the State of the operator and by a person duly licensed or otherwise permitted to operate the radio station under that law.

- (a) (2) (a) Subject to sub-paragraph (b), whenever an aircraft is in flight in such circumstances that it is required by or under this Order to be equipped with radio communications apparatus, a continuous radio watch shall be maintained by a member of the flight crew listening to the signals transmitted upon the frequency notified, or designated by a message received from an appropriate aeronautical radio station, for use by that aircraft.
- (b) (i) The radio watch may be discontinued or continued on another frequency to the extent that a message as aforesaid so permits.
- (ii) The watch may be kept by a device installed in the aircraft if:
 - (aa) the appropriate aeronautical radio station has been informed to that effect and has raised no objection; and
 - (bb) that station is notified, or in the case of a station situated in a country other than the Territory, otherwise designated as transmitting a signal suitable for that purpose.

(3) Whenever an aircraft is in flight in such circumstances that it is required by or under this Order to be equipped with radio or radio navigation equipment a member of the flight crew shall operate that equipment in such a manner as he may be instructed by the appropriate air traffic control unit or as may be notified in relation to any notified airspace in which the aircraft is flying.

(4) The radio station in an aircraft shall not be operated so as to cause interference which impairs the efficiency of aeronautical telecommunications or navigational services, and in particular emissions shall not be made except as follows:

- (a) emissions of the class and frequency for the time being in use, in accordance with general international aeronautical practice, in the airspace in which the aircraft is flying;
- (b) distress, urgency and safety messages and signals, in accordance with general international aeronautical practice;
- (c) messages and signals relating to the flight of the aircraft, in accordance with general international aeronautical practice; and
- (d) such public correspondence messages as may be permitted by or under the aircraft radio station licence referred to in paragraph (1).

(5) In any flying machine registered in the Territory which is engaged on a flight for the purpose of public transport the pilot and the flight engineer (if any) shall not make use of a hand-held microphone (whether for the purpose of radio communication or of intercommunication within the aircraft) whilst the aircraft is flying in controlled airspace below flight level 150 or is taking off or landing.

Minimum navigation performance

47.—(1) An aircraft registered in the Territory shall not fly in North Atlantic Minimum Navigation Performance Specification airspace unless it is equipped with navigation systems which enable the aircraft to maintain the navigation performance capability specified in regulation 19(1) in Schedule 14 to this Order.

(2) The equipment required by paragraph (1) shall be approved by the Governor, installed and maintained in a manner approved by the Governor and shall, while the aircraft is flying in the said airspace, be operated in accordance with procedures approved by the Governor.

(3) An approval granted by the Governor for the purposes of this article shall be in writing and may be subject to such conditions as the Governor thinks fit.

Height keeping performance—aircraft registered in the Territory

48.—(1) Unless otherwise authorised by the appropriate air traffic control unit, an aircraft registered in the Territory shall not fly in reduced vertical separation minimum airspace notified for the purpose of this article, unless it is equipped with height keeping systems which enable the aircraft to maintain the height keeping performance capability specified in regulation 19(2) in Schedule 14 to this Order.

(2) The equipment required by paragraph (1) shall be approved by the Governor, installed and maintained in a manner approved by the Governor and shall, while the aircraft is flying in the said airspace, be operated in accordance with procedures approved by the Governor.

(3) An approval granted by the Governor for the purposes of this article shall be in writing and may be subject to such conditions as the Governor thinks fit.

Height keeping performance—aircraft not registered in the Territory

49. Unless otherwise authorised by the appropriate air traffic control unit an aircraft registered elsewhere than in the Territory shall not fly in Territory reduced vertical separation minimum airspace unless:

- (a) it is so equipped with height keeping systems as to comply with the law of the country in which the aircraft is registered insofar as that law requires it to be so equipped when flying in any specified areas; and
- (b) the said equipment is capable of being operated so as to enable the aircraft to maintain the height keeping performance notified in respect of the airspace in which the aircraft is flying, and it is so operated.

Area navigation equipment—aircraft registered in the Territory

50.—(1) An aircraft registered in the Territory shall not fly in controlled airspace notified for the purposes of this paragraph as an area navigation route or area unless:

- (a) it is equipped with area navigation equipment which is approved by the Governor in relation to the purpose for which it is to be used, and which is installed and maintained in a manner approved by the Governor; and
- (b) the said equipment is capable of being operated so as to enable the aircraft to maintain the navigation accuracy notified in respect of the airspace in which the aircraft is flying, and it is so operated.

(2) An aircraft registered in the Territory shall not, when flying in controlled airspace notified for the purposes of this paragraph, not being an area navigation route or area, be navigated by means of area navigation equipment unless:

- (a) the said equipment is approved by the Governor in relation to the purpose for which it is to be used, and is installed and maintained in a manner approved by the Governor; and
- (b) the said equipment is capable of being operated so as to enable the aircraft to maintain the navigation accuracy notified in respect of the airspace in which the aircraft is flying, and it is so operated.

- (a) (3) (a) For the purposes of this article, an approval shall be in writing and may be subject to such conditions as the Governor thinks fit.
- (b) An approval may be granted in respect of any aircraft or specified class or category of aircraft or in respect of a specified type or types of equipment.

Area navigation equipment—aircraft not registered in the Territory

51.—(1) An aircraft registered elsewhere than in the Territory shall not fly in controlled airspace notified for the purposes of paragraph (1) of article 50 unless:

- (a) it is so equipped with area navigation equipment as to comply with the law of the country in which the aircraft is registered insofar as that law requires it to be equipped when flying within any specified areas; and
- (b) the said equipment is capable of being operated so as to enable the aircraft to maintain the navigation accuracy notified in respect of the airspace in which the aircraft is flying, and it is so operated.

(2) An aircraft registered elsewhere than in the Territory shall not, when flying in controlled airspace notified for the purposes of paragraph (2) of article 50, be navigated by means of area navigation equipment unless:

- (a) the said equipment complies with the law of the country in which the aircraft is registered insofar as that law requires it to be so equipped when flying within any specified areas; and
- (b) the said equipment is capable of being operated so as to enable the aircraft to maintain the navigation accuracy notified in respect of the airspace in which the aircraft is flying, and it is so operated.

Use of airborne collision avoidance system

52. On any flight on which an airborne collision avoidance system is required by paragraph 1 of Schedule 5 to this Order to be carried in an aeroplane, the system shall be operated:

- (a) in the case of an aircraft to which article 31 applies, in accordance with procedures contained in the Operations Manual for the aircraft;
- (b) in the case of an aircraft registered in the Territory to which article 31 does not apply, in accordance with procedures which are suitable having regard to the purposes of the equipment; or
- (c) in the case of an aircraft which is registered elsewhere than in the Territory, in accordance with any procedures with which it is required to comply under the law of the country in which the aircraft is registered.

Use of flight recording systems and preservation of records

53.—(1) On any flight on which a flight data recorder, a cockpit voice recorder or a combined cockpit voice recorder/flight data recorder is required by paragraph 4(4), (5), (6) or (7) of Schedule 4 to this Order to be carried in an aeroplane, it shall always be in use from the beginning of the take-off run to the end of the landing run.

- (2) The operator of the aeroplane shall at all times, subject to article 80 of this Order, preserve:
 - (a) the last 25 hours of recording made by any flight data recorder required by or under this Order to be carried in an aeroplane; and
 - (b) a record of not less than one representative flight, that is to say, a recording of a flight made within the last 12 months which includes a take-off, climb, cruise, descent, approach

to landing and landing, together with a means of identifying the record with the flight to which it relates;

and shall preserve such records for such period as the Governor may in a particular case direct.

(3) On any flight on which a cockpit voice recorder, a flight data recorder or a combined cockpit voice recorder/flight data recorder is required by paragraph 4(16) of Schedule 4 to this Order to be carried in a helicopter, it shall always be in use from the time the rotors first turn for the purpose of taking off until the rotors are next stopped.

(4) The operator of the helicopter shall at all times, subject to article 80 of this Order, preserve:

- (a) the last 8 hours of recording made by any flight data recorder specified at sub-paragraph (i) or (ii) of Scale SS of paragraph 5 of Schedule 4 to this Order and required by or under this Order to be carried in the helicopter;
- (b) in the case of a combined cockpit voice recorder/flight data recorder specified at sub-paragraph (iii) of the said Scale SS and required by or under this Order to be carried in a helicopter either:
 - (i) the last 8 hours of recording; or
 - (ii) the last 5 hours of recording or the duration of the last flight, whichever is the greater, together with an additional period of recording for either:
 - (aa) the period immediately preceding the last 5 hours of recording or the duration of the last flight, whichever is the greater; or
 - (bb) such period or periods as the Governor may permit in any particular case or class of cases or generally.

(5) The additional recording retained pursuant to sub-paragraphs (b)(ii)(aa) and (bb) of paragraph (4) shall, together with the recording required to be retained pursuant to sub-paragraph (b)(ii) of paragraph (4), total a period of 8 hours and shall be retained in accordance with arrangements approved by the Governor.

(6) An approval granted by the Governor for the purposes of this article shall be in writing and may be subject to such conditions as the Governor thinks fit.

Towing of gliders

54.—(1) An aircraft in flight shall not tow a glider unless the certificate of airworthiness issued or rendered valid in respect of the towing aircraft under the law of the country in which that aircraft is registered includes an express provision that it may be used for that purpose.

(2) The length of the combination of towing aircraft, tow rope and glider in flight shall not exceed 150 metres.

(3) The commander of an aircraft which is about to tow a glider shall satisfy himself, before the towing aircraft takes off:

- (a) that the tow rope is in good condition and is of adequate strength for the purpose, and that the combination of towing aircraft and glider, having regard to its performance in the conditions to be expected on the intended flight and to any obstructions at the place of departure and on the intended route, is capable of safely taking off, reaching and maintaining a safe height at which to separate the combination and that thereafter the towing aircraft can make a safe landing at the place of intended destination;
- (b) that signals have been agreed and communication established with persons suitably stationed so as to enable the glider to take off safely; and
- (c) that emergency signals have been agreed between the commander of the towing aircraft and the commander of the glider, to be used, respectively, by the commander of the towing

aircraft to indicate that the tow should immediately be released by the glider, and by the commander of the glider to indicate that the tow cannot be released.

(4) The glider shall be attached to the towing aircraft by means of the tow rope before the aircraft takes off.

Towing, picking up and raising of persons and articles

55.—(1) Subject to the provisions of this article, an aircraft in flight shall not, by means external to the aircraft, tow any article, other than a glider, or pick up or raise any person, animal or article, unless the certificate of airworthiness issued or rendered valid in respect of that aircraft under the law of the country in which the aircraft is registered includes an express provision that it may be used for that purpose.

(2) An aircraft shall not launch or pick up tow ropes, banners or similar articles other than at an aerodrome.

(3) An aircraft in flight shall not tow any article, other than a glider, at night or when flight visibility is less than one nautical mile.

(4) The length of the combination of towing aircraft, tow rope, and article in tow, shall not exceed 150 metres.

(5) A helicopter shall not fly at any height over a congested area of a city, town or settlement at any time when any article, person or animal is suspended from the helicopter.

(6) A passenger shall not be carried in a helicopter at any time when an article, person or animal is suspended therefrom, other than a passenger who has duties to perform in connection with the article, person or animal or a passenger who has been picked up or raised by means external to the helicopter or a passenger who it is intended shall be lowered to the surface by such means.

(7) Nothing in this article shall:

- (a) prohibit the towing in a reasonable manner by an aircraft in flight of any radio aerial, any instrument which is being used for experimental purposes, or any signal, apparatus or article required or permitted by or under this Order to be towed or displayed by an aircraft in flight;
- (b) prohibit the picking up or raising of any person, animal or article in an emergency or for the purpose of saving life;
- (c) apply to any aircraft while it is flying in accordance with the “B Conditions” set forth in Part A of Schedule 3 to this Order; or
- (d) be taken to permit the towing or picking up of a glider otherwise than in accordance with article 54 of this Order.

Dropping of articles and animals

56.—(1) Articles and animals (whether or not attached to a parachute) shall not be dropped, or permitted to drop, from an aircraft in flight so as to endanger persons or property.

(2) Subject to paragraph (3), except under and in accordance with the terms of an aerial application certificate granted under article 58 of this Order, articles and animals (whether or not attached to a parachute) shall not be dropped, or permitted to drop, to the surface from an aircraft flying over the Territory.

(3) Paragraph (2) shall not apply to the dropping of articles by, or with the authority of, the commander of the aircraft in any of the following circumstances:

- (a) the dropping of articles for the purpose of saving life;
- (b) the jettisoning, in case of emergency, of fuel or other articles in the aircraft;

- (c) the dropping of ballast in the form of fine sand or water;
- (d) the dropping of articles solely for the purpose of navigating the aircraft in accordance with ordinary practice or with the provisions of this Order;
- (e) the dropping at an aerodrome of tow ropes, banners, or similar articles towed by aircraft;
- (f) the dropping of articles for the purposes of public health or as a measure against weather conditions, surface icing or oil pollution, or for training for the dropping of articles for any such purposes, if the articles are dropped with the permission of the Governor and in accordance with any conditions subject to which that permission may have been given; or
- (g) the dropping of wind drift indicators for the purpose of enabling parachute descents to be made if the wind drift indicators are dropped with the permission of the Governor and in accordance with any conditions subject to which that permission may have been given.

(4) For the purpose of this article “dropping” includes projecting and lowering.

(5) Nothing in this article shall prohibit the lowering of any article or animal from a helicopter to the surface, if the certificate of airworthiness issued or rendered valid in respect of the helicopter under the law of the country in which it is registered includes an express provision that it may be used for that purpose.

Dropping of persons

57.—(1) A person shall not drop, be dropped or permitted to drop to the surface or jump from an aircraft flying over the Territory except under and in accordance with the terms of either a police air operator’s certificate or a written permission granted by the Governor under this article.

(2) For the purposes of this article “dropping” includes projecting and lowering.

(3) Notwithstanding the grant of a police air operator’s certificate or a permission under paragraph (1), a person shall not drop, be dropped or be permitted to drop from an aircraft in flight so as to endanger persons or property.

(4) An aircraft shall not be used for the purpose of dropping persons unless:

- (a) the certificate of airworthiness issued or rendered valid in respect of that aircraft under the law of the country in which the aircraft is registered includes an express provision that it may be used for that purpose and the aircraft is operated in accordance with a written permission granted by the Governor under this article; or
- (b) the aircraft is operated under and in accordance with the terms of a police air operator’s certificate.

(5) (a) Every applicant for and holder of a permission shall make available to the Governor if requested to do so a parachuting manual and shall make such amendments or additions to such manual as the Governor may require.

(b) (i) The holder of a permission shall make the manual available to every employee or person who is or may engage in parachuting activities conducted by him.

(ii) The manual shall contain all such information and instruction as may be necessary to enable such employees or persons to perform their duties.

(6) Nothing in this article shall apply to the descent of persons by parachute from an aircraft in an emergency.

(7) Nothing in this article shall prohibit the lowering of any person in an emergency or for the purpose of saving life.

(8) Nothing in this article shall prohibit the lowering of any person from a helicopter to the surface if the certificate or airworthiness issued or rendered valid in respect of the helicopter under

the law of the country in which it is registered includes an express provision that it may be used for that purpose.

Issue of aerial application certificates

58.—(1) An aircraft shall not be used for the dropping of articles for the purposes of agriculture, horticulture or forestry or for training for the dropping of articles for any of such purposes, otherwise than under and in accordance with the terms of an aerial application certificate granted to the operator of the aircraft under paragraph (2).

- (a) (2) (a) The Governor shall grant an aerial application certificate if he is satisfied that the applicant is a fit person to hold the certificate and is competent, having regard in particular to his previous conduct and experience, his equipment, organisation, staffing and other arrangements, to secure the safe operation of the aircraft specified in the certificate on flights for the purposes specified in paragraph (1).
- (b) A certificate may be granted subject to such conditions as the Governor thinks fit including, without prejudice to the generality of the foregoing, conditions for ensuring that the aircraft and any article dropped from it do not endanger persons or property in the aircraft or elsewhere, and shall, subject to article 81 of this Order, remain in force for the period specified in the certificate.

(3) Every applicant for and holder of an aerial application certificate shall make available to the Governor upon application and to every member of his operating staff upon the certificate being granted, an aerial application manual which shall contain all such information and instructions as may be necessary to enable the operating staff to perform their duties as such. The holder of a certificate shall make such amendments of or additions to the manual as the Governor may require.

(4) For the purposes of this article “operating staff” has the meaning ascribed to it in article 31(4) of this Order.

Carriage of weapons and of munitions of war

59.—(1) Subject to paragraph (4) an aircraft shall not carry any munition of war unless:

- (a) such munition of war is carried with the written permission of the Governor and in accordance with any conditions relating thereto;
 - (b) subject to sub-paragraph (c), the commander of the aircraft is informed in writing by the operator before the flight commences of the type, weight or quantity and location of any such munition of war on board or suspended beneath the aircraft and any conditions of the permission of the Governor; and
 - (c) in the case of an aircraft which is flying under and in accordance with the terms of a police air operator’s certificate the commander of the aircraft is informed of the matters referred to in sub-paragraph (b) but he need not be so informed in writing.
- (a) (2) (a) Notwithstanding paragraph (1) it shall, subject to sub-paragraph (b), be unlawful for an aircraft to carry any sporting weapon or munition of war in any compartment or apparatus to which passengers have access;
 - (b) sub-paragraph (a) shall not apply to an aircraft which is flying under and in accordance with the terms of a police air operator’s certificate.
- (a) (3) (a) Subject to sub-paragraph (b), it shall be unlawful for a person to carry or have in his possession or take or cause to be taken on board an aircraft, to suspend or cause to be suspended beneath an aircraft or to deliver or cause to be delivered for carriage thereon any sporting weapon or munition of war unless:
 - (i) the sporting weapon or munition of war:

- (aa) is either part of the baggage of a passenger on the aircraft or consigned as cargo to be carried thereby;
 - (bb) is carried in a part of the aircraft, or in any apparatus attached to the aircraft inaccessible to passengers; and
 - (cc) in the case of a firearm, is unloaded.
 - (ii) particulars of the sporting weapon or munition of war have been furnished by that passenger or by the consignor to the operator before the flight commences; and
 - (iii) without prejudice to paragraph (1) the operator consents to the carriage of such sporting weapon or munition of war by the aircraft.
- (b) Sub-paragraph (a) shall not apply to or in relation to an aircraft which is flying under and in accordance with the terms of a police air operator's certificate.
- (4) Nothing in this article shall apply to any sporting weapon or munition of war taken or carried on board an aircraft registered in a country other than the Territory if the sporting weapon or munition of war, as the case may be, may under the law of the country in which the aircraft is registered be lawfully taken or carried on board for the purpose of ensuring the safety of the aircraft or of persons on board.
- (5) For the purposes of this article:
- (a) "munition of war" means:
 - (i) any weapon or ammunition;
 - (ii) any article containing an explosive, noxious liquid or gas; or
 - (iii) any other thing;
 which is designed or made for use in warfare or against persons, including parts, whether components or accessories, for such weapon, ammunition or article.
 - (b) "sporting weapon" means:
 - (i) any weapon or ammunition;
 - (ii) any article containing an explosive, noxious liquid or gas; or
 - (iii) any other thing, including parts, whether components or accessories, for such weapon, ammunition or article;
 which is not a munition of war.

Carriage of dangerous goods

60.—(1) It shall be an offence to contravene or permit the contravention of or fail to comply with any of the regulations set out in Schedule 15 to this Order.

(2) The Governor may, with the approval of the Secretary of State, make regulations which supplement, amend or replace the regulations set out in the said Schedule 15, and which prescribe:

- (a) the classification of certain articles and substances as dangerous goods;
- (b) the categories of dangerous goods which an aircraft may not carry;
- (c) the conditions which apply to the loading on, suspension beneath and carriage by an aircraft of dangerous goods;
- (d) the manner in which dangerous goods must be packed, marked, labelled and consigned before being loaded on, suspended beneath or carried by an aircraft;
- (e) any other provisions for securing the safety of aircraft and any apparatus attached thereto and the safety of persons and property on the surface in relation to the loading on, suspension beneath or carriage by an aircraft of dangerous goods;

- (f) the persons to whom information about the carriage of dangerous goods must be provided;
- (g) the documents relating to the carriage by an aircraft of dangerous goods which must be produced to the Governor or an authorised person on request;
- (h) the powers to be conferred on an authorised person relating to the enforcement of the regulations made hereunder.

(3) The provisions of paragraph (1) of this article shall be without prejudice to any other provisions of this Order; and the provisions of paragraph (1) of this article, of Schedule 15 to this Order and of any regulations supplementing, amending or replacing the regulations set out in the said Schedule 15 shall be additional to and not in derogation from the provisions of Article 59 of this Order.

Method of carriage of persons

- (a) **61.** (1) (a) Subject to paragraphs (2) and (3), a person shall not be in or on any part of an aircraft in flight which is not a part designed for the accommodation of persons and in particular a person shall not be on the wings or undercarriage of an aircraft.
- (b) A person shall not be in or on any object, other than a glider or flying machine, towed by or attached to an aircraft in flight.
- (2) A person may have temporary access to:
 - (a) any part of an aircraft for the purpose of taking action necessary for the safety of the aircraft or of any person, animal or goods therein; and
 - (b) any part of an aircraft in which cargo or stores are carried, being a part which is designed to enable a person to have access thereto while the aircraft is in flight.

(3) This article shall not apply to a passenger in a helicopter flying under and in accordance with a police air operator's certificate who is disembarking in accordance with a procedure contained in the police operations manual for the helicopter.

Exits and break-in markings

62.—(1) Subject to paragraph (5)(b), this article shall apply to every public transport aircraft registered in the Territory.

- (a) (2) (a) Whenever an aircraft to which this article applies is carrying passengers, every exit therefrom and every internal door in the aircraft shall be in working order, and, subject to sub-paragraph (b), during take-off and landing and during any emergency, every such exit and door shall be kept free from obstruction and shall not be fastened by locking or otherwise so as to prevent, hinder or delay its use by passengers.
- (b) (i) An exit may be obstructed by cargo if it is an exit which, in accordance with arrangements approved by the Governor either generally or in relation to a class of aircraft or a particular aircraft, is not required for use by passengers.
- (ii) A door between the flight crew compartment and any adjacent compartment to which passengers have access may be locked or bolted if the commander of the aircraft so determines, for the purpose of preventing access by passengers to the flight crew compartment.
- (iii) Nothing in this paragraph shall apply to any internal door which is so placed that it cannot prevent, hinder or delay the exit of passengers from the aircraft in an emergency if it is not in working order.

(3) Every exit from the aircraft shall be marked with the words "Exit" or "Emergency Exit" in capital letters.

- (a) (4) (a) Every exit from the aircraft shall be marked with instructions in English and with diagrams to indicate the correct method of opening the exit.
- (b) The markings shall be placed on or near the inside surface of the door or other closure of the exit and, if it is openable from the outside of the aircraft, on or near the exterior surface.
- (a) (i) Every aircraft to which this article applies, being an aircraft of which the maximum total weight authorised exceeds 3,600 kg, shall be marked upon the exterior surface of its fuselage with markings to show the areas (in this paragraph referred to as “break-in areas”) which can, for purposes of rescue in an emergency, be most readily and effectively broken into by persons outside the aircraft.
- (ii) The break-in areas shall be rectangular in shape and shall be marked by right-angled corner markings, each arm of which shall be 10 centimetres in length along its outer edge and 2.5 centimetres in width.
- (iii) The words “Cut Here in Emergency” shall be marked across the centre of each break-in area in capital letters.
- (b) This paragraph shall not apply to helicopters.
- (6) On every flight by an aircraft to which this article applies, being an aircraft of which the maximum total weight authorised exceeds 5,700 kg, every exit from such an aircraft intended to be used by passengers in an emergency shall be marked upon the exterior of the aircraft by a band not less than 5 centimetres in width outlining the exit.
- (7) The markings required by this article shall:
 - (a) be painted, or affixed by other equally permanent means;
 - (b) except in the case of the markings required by paragraph (6), be red in colour, and in any case in which the colour of the adjacent background is such as to render red markings not readily visible, be outlined in white or some other contrasting colour in such a manner as to render them readily visible;
 - (c) in the case of the markings required by paragraph (6), be of a colour clearly contrasting with the background on which it appears; and
 - (d) be kept at all times clean and unobscured.
- (a) (8) (a) Subject to compliance with sub-paragraph (b), if one, but not more than one, exit from an aircraft becomes inoperative at a place where it is not reasonably practicable for it to be repaired or replaced, nothing in this article shall prevent that aircraft from carrying passengers until it next lands at a place where the exit can be repaired or replaced.
- (b) On any flight pursuant to this paragraph:
 - (i) the number of passengers carried and the position of the seats which they occupy shall be in accordance with arrangements approved by the Governor either in relation to the particular aircraft or to a class of aircraft; and
 - (ii) in accordance with arrangements so approved, the exit shall be fastened by locking or otherwise, the words “Exit” or “Emergency Exit” shall be covered, and the exit shall be marked by a red disc at least 23 centimetres in diameter with a horizontal white bar across it bearing the words “No Exit” in red letters.

Endangering safety of an aircraft

63. A person shall not recklessly or negligently act in a manner likely to endanger an aircraft, or any person therein.

Endangering safety of any person or property

64. A person shall not recklessly or negligently cause or permit an aircraft to endanger any person or property.

Drunkenness in aircraft

65.—(1) A person shall not enter any aircraft when drunk, or be drunk in any aircraft.

(2) A person shall not, when acting as a member of the crew of any aircraft or being carried in any aircraft for the purpose of so acting, be under the influence of drink or a drug to such an extent as to impair his capacity so to act.

Smoking in aircraft

66.—(1) Notices indicating when smoking is prohibited shall be exhibited in every aircraft registered in the Territory so as to be visible from each passenger seat therein.

(2) A person shall not smoke in any compartment of an aircraft registered in the Territory at a time when smoking is prohibited in that compartment by a notice to that effect exhibited by or on behalf of the commander of the aircraft.

Authority of commander and members of the crew of an aircraft

67. Every person in an aircraft shall obey all lawful commands which the commander of that aircraft may give for the purpose of securing the safety of the aircraft and of persons or property carried therein, or the safety, efficiency or regularity of air navigation.

Acting in a disruptive manner

68. No person shall while in an aircraft:

- (a) use any threatening, abusive or insulting words towards a member of the crew of the aircraft;
- (b) behave in a threatening, abusive, insulting or disorderly manner towards a member of the crew of the aircraft; or
- (c) intentionally interfere with the performance by a member of the crew of the aircraft or his duties.

Stowaways

69. A person shall not secrete himself for the purpose of being carried in an aircraft without the consent of either the operator or the commander thereof or of any other person entitled to give consent to his being carried in the aircraft.

Flying Displays

70.—(1) No person shall act as the organiser of a flying display (in this article referred to as “the flying display director”) unless he has obtained the permission in writing of the Governor under paragraph (4) for that flying display and complies with any conditions therein specified.

- (a) (2) (a) The commander of an aircraft intending to participate in a flying display shall take all reasonable steps to satisfy himself before he participates that:
 - (i) the flying display director has been granted an appropriate permission under paragraph (4);

- (ii) the flight can comply with any relevant conditions subject to which that permission may have been granted; and
 - (iii) the pilot has been granted an appropriate pilot display authorisation.
 - (b) The commander of an aircraft participating in a flying display for which a permission has been granted shall comply with any conditions subject to which that permission may have been granted.
 - (c) No person shall act as pilot of an aircraft participating in a flying display unless he holds an appropriate pilot display authorisation and he complies with any conditions subject to which the authorisation may have been given.
- (3) The flying display director shall not permit any person to act as pilot of an aircraft which participates in a flying display unless such person holds an appropriate pilot display authorisation.
- (a) (4) (a) The Governor shall grant a permission required by virtue of paragraph (1) if he is satisfied that the applicant is a fit and competent person, having regard in particular to his previous conduct and experience, his organisation, staffing and other arrangements, to safely organise the proposed flying display.
 - (b) The permission may be granted subject to such conditions, which may include conditions in respect of military aircraft, as the Governor thinks fit and shall, subject to article 81 of this Order, remain in force for the period specified in the permission.
- (5) The Governor shall, for the purpose of this article, either unconditionally or subject to such conditions as he thinks fit:
- (a) grant a display authorisation authorising the holder to act as pilot of an aircraft taking part in a flying display upon his being satisfied that the applicant is a fit person to hold the authorisation and is qualified by reason of his knowledge, experience, competence, skill, physical and mental fitness to fly in accordance therewith and for that purpose the applicant shall furnish such evidence and undergo such examinations and tests as the Governor may require; and
 - (b) authorise a person to conduct such examinations or tests as he may specify.
- (6) A pilot display authorisation granted in accordance with this article shall, subject to article 81 of this Order, remain in force for the period indicated in the pilot display authorisation.
- (7) For the purposes of this article, an appropriate pilot display authorisation shall mean such an authorisation which is valid and appropriate to the intended flight and which has been granted by the Governor pursuant to paragraph (5)(a).
- (8) Paragraph (1) shall not apply to either:
- (a) a flying display which takes place at an aerodrome in the occupation of the Ministry of Defence or of any visiting force or any other premises in the occupation or under the control of the Ministry of Defence; or
 - (b) a flying display at which the only participating aircraft are military aircraft.
- (9) The flying display director shall not permit any military aircraft to participate in a flying display unless he complies with any conditions specified in respect of military aircraft subject to which permission for the flying display may have been granted.
- (10) Nothing in this article shall apply to an aircraft race or contest or to an aircraft taking part in such a race or contest or to the commander or pilot thereof whether or not such race or contest is held in association with a flying display.

PART VI

Fatigue of Crew

Application and interpretation of Part VI

- (a) **71.** (1) (a) Subject to sub-paragraph (b), articles 72 and 73 of this Order apply in relation to any aircraft registered in the Territory which is either:
 - (i) engaged on a flight for the purpose of public transport; or
 - (ii) operated by an air transport undertaking.
- (b) Articles 72 and 73 of this Order shall not apply in relation to a flight made only for the purpose of instruction in flying given by or on behalf of a flying club or flying school, or a person who is not an air transport undertaking.
- (2) For the purposes of this Order:
 - (a) “flight time”, in relation to any person, means all time spent by that person in:
 - (i) a civil aircraft whether or not registered in the Territory (other than such an aircraft of which the maximum total weight authorised does not exceed 1,600 kg and which is not flying for the purpose of public transport or aerial work); or
 - (ii) a military aircraft,while it is in flight and he is carried therein as a member of the crew thereof;
 - (b) “day” means a continuous period of 24 hours beginning at midnight Co-ordinated Universal Time; and
 - (c) a helicopter shall be deemed to be in flight from the moment the helicopter first moves under its own power for the purpose of taking off until the rotors are next stopped.

Fatigue of crew—operator’s responsibilities

72.—(1) The operator of an aircraft to which this article applies shall not cause or permit that aircraft to make a flight unless:

- (a) he has established a scheme for the regulation of flight times for every person flying in that aircraft as a member of its crew;
 - (b) the scheme is approved by the Governor subject to such conditions as he thinks fit;
 - (c) either:
 - (i) the scheme is incorporated in the operations manual required by article 31 of this Order; or
 - (ii) in any case where an operations manual is not required by that article, the scheme is incorporated in a document, a copy of which has been made available to every person flying in that aircraft as a member of its crew; and
 - (d) he has taken all such steps as are reasonably practicable to ensure that the provisions of the scheme will be complied with in relation to every person flying in that aircraft as a member of its crew.
- (2) The operator of an aircraft to which this article applies shall not cause or permit any person to fly therein as a member of its crew if he knows or has reason to believe that the person is suffering from, or, having regard to the circumstances of the flight to be undertaken, is likely to suffer from, such fatigue while he is so flying as may endanger the safety of the aircraft or of its occupants.
- (3) The operator of an aircraft to which this article applies shall not cause or permit any person to fly therein as a member of its flight crew unless the operator has in his possession an accurate

and up-to-date record in respect of that person and in respect of the 28 days immediately preceding the flight showing:

- (a) all his flight times; and
- (b) brief particulars of the nature of the functions performed by him in the course of his flight times.

(4) The record referred to in paragraph (3) shall, subject to article 80, be preserved by the operator of the aircraft until a date 12 months after the flight referred to in that paragraph.

Fatigue of crew—responsibilities of crew

73.—(1) A person shall not act as a member of the crew of an aircraft to which this article applies if he knows or suspects that he is suffering from, or, having regard to the circumstances of the flight to be undertaken, is likely to suffer from, such fatigue as may endanger the safety of the aircraft or of its occupants.

(2) A person shall not act as a member of the flight crew of an aircraft to which this article applies unless he has ensured that the operator of the aircraft is aware of his flight times during the period of 28 days preceding the flight.

Flight times—responsibilities of flight crew

74.—(1) Subject to paragraph (2), a person shall not act as a member of the flight crew of an aircraft registered in the Territory if at the beginning of the flight the aggregate of all his previous flight times:

- (a) during the period of 28 consecutive days expiring at the end of the day on which the flight begins exceeds 100 hours; or
 - (b) during the period of twelve months expiring at the end of the previous month exceeds 900 hours.
- (2) (a) This article shall not apply to a flight made in circumstances specified in subparagraph (b).
- (b) (i) A private flight in an aircraft of which the maximum total weight does not exceed 1,600 kg; or
 - (ii) a flight which is not for the purpose of public transport and is not operated by an air transport undertaking where, at the time when the flight begins, the aggregate of all the flight times of the member of the flight crew concerned since he was last medically examined and found fit by a person approved by the Governor for the purpose of article 25(1)(b) does not exceed 25 hours.

Protection of air crew from cosmic radiation

75.—(1) A relevant undertaking shall take appropriate measures to:

- (a) assess the exposure to cosmic radiation when in flight of those air crew who are liable to be subject to cosmic radiation in excess of 1 milliSievert per year;
- (b) take into account the assessed exposure when organising work schedules with a view to reducing the doses of highly exposed air crew; and
- (c) inform the workers concerned of the health risks their work involves.

(2) A relevant undertaking shall ensure that in relation to a pregnant air crew member, the conditions of exposure to cosmic radiation when she is in flight are such that the equivalent dose to the foetus will be as low as reasonably achievable and is unlikely to exceed 1 milliSievert during the remainder of the pregnancy.

(3) Nothing in paragraph (2) shall require the undertaking concerned to take any action in relation to an air crew member until she has notified the undertaking in writing that she is pregnant.

(4) The definition in article 130 of “crew” shall not apply for the purposes of this article.

(5) In this article and in article 77:

- (a) “air crew” means every person employed or engaged in an aircraft in flight on the business of the aircraft;
- (b) “undertaking” includes a natural or legal person and, subject to paragraph (6), “relevant undertaking” means an undertaking which operates aircraft and is established in the Territory; and
- (c) “year” means any period of twelve months.

PART VII

Documents and Records

Documents to be carried

76.—(1) An aircraft shall not fly unless it carries the documents which it is required to carry under the law of the country in which it is registered.

- (a) (2) (a) Subject to sub-paragraph (b), an aircraft registered in the Territory shall, when in flight, carry documents in accordance with Schedule 11 to this Order.
- (b) If the flight is intended to begin and end at the same aerodrome and does not include passage over the territory of any country other than the Territory, the documents may be kept at that aerodrome instead of being carried in the aircraft.

Keeping and production of records of exposure to cosmic radiation

77.—(1) A relevant undertaking shall keep a record for the period and in the manner prescribed in Schedule 17 to this Order of the exposure to cosmic radiation of air crew assessed under article 75 and the names of the air crew concerned.

(2) A relevant undertaking shall, within a reasonable period after being requested to do so by an authorised person, cause to be produced to that person the record required to be kept under paragraph (1).

(3) A relevant undertaking shall, within a reasonable period after being requested to do so by a person in respect of whom a record is required to be kept under paragraph (1), supply a copy of that record to that person.

Production of documents and records

78.—(1) The commander of an aircraft shall, within a reasonable time after being requested to do so by an authorised person, cause to be produced to that person:

- (a) the certificates of registration and airworthiness in force in respect of the aircraft;
- (b) the licences of its flight crew; and
- (c) such other documents as the aircraft is required by article 76 of this Order to carry when in flight.

(2) The operator of an aircraft registered in the Territory shall, within a reasonable time after being requested to do so by an authorised person, cause to be produced to that person such of the following

documents or records as may have been requested by that person being documents or records which are required, by or under this Order, to be in force or to be carried, preserved or made available:

- (a) the documents referred to in Schedule 11 to this Order as Documents A, B and G;
 - (b) the aircraft log book, engine log books and variable pitch propeller log books required under this Order to be kept;
 - (c) the weight schedule, if any, required to be preserved under article 18 of this Order;
 - (d) in the case of a public transport aircraft or aerial work aircraft, the documents referred to in Schedule 11 to this Order as Documents D and H;
 - (e) in the case of an aircraft in respect of which a certificate of airworthiness in either the transport or aerial work category is in force, the documents referred to in Schedule 11 to this Order as Documents E and F;
 - (f) any records of flight times, duty periods and rest periods which he is required by article 72(4) of this Order to preserve, and such other documents and information in the possession or control of the operator, as the authorised person may require for the purpose of determining whether those records are complete and accurate;
 - (g) any such operations manuals as are required to be made available under article 31(2)(a)(i) of this Order;
 - (h) the record made by any flight data recorder required to be carried by or under this Order.
- (a) (3) (a) The holder of a licence granted or rendered valid under this Order shall, within a reasonable time after being requested to do so by an authorised person, cause to be produced to that person his licence, including any certificate of validation. The requirements of this paragraph shall be deemed to have been complied with, except in relation to licences required by article 76 to be carried in the aircraft or kept at an aerodrome, if the licence requested is produced within five days after the request has been made at a police station in the Territory specified, at the time the request is made, by the person to whom the request is made.
- (b) The foregoing provisions of this paragraph shall apply to a medical certificate required pursuant to article 21(2)(b)(ii) of this Order as they apply to a licence granted or rendered valid under this Order.

(4) Every person required by article 28 of this Order to keep a personal flying log book shall cause it to be produced within a reasonable time to an authorised person after being requested to do so by him within two years after the date of the last entry therein.

Power to inspect and copy documents and records

79. An authorised person shall have the power to inspect and copy any certificate, licence, log book, document or record which he has the power pursuant to this Order and any regulations made thereunder to require to be produced to him.

Preservation of documents, etc.

80.—(1) Subject to paragraph (2), a person required by this Order to preserve any document or record by reason of his being the operator of an aircraft shall, if he ceases to be the operator of the aircraft, continue to preserve the document or record as if he had not ceased to be the operator, and in the event of his death the duty to preserve the document or record shall fall upon his personal representative.

- (a) (2) (a) If another person becomes the operator of the aircraft, the first-mentioned operator or his personal representative shall deliver to that person upon demand the certificates of maintenance review and release to service, the log books and the weight

schedule and any record made by a flight data recorder and preserved in accordance with article 53(2) and (4) of this Order which are in force or required to be preserved in respect of that aircraft.

- (b) If an engine or variable pitch propeller is removed from the aircraft and installed in another aircraft operated by another person the first-mentioned operator or his personal representative shall deliver to that person upon demand the log book relating to that engine or propeller.
- (c) If any person in respect of whom a record has been kept by the first mentioned operator in accordance with article 72(4) of this Order becomes a member of the flight crew of a public transport aircraft registered in the Territory and operated by another person the first-mentioned operator or his personal representative shall deliver those records to that other person upon demand.
- (d) It shall be the duty of the other person referred to in sub-paragraphs (a), (b) and (c) to deal with the document or record delivered to him as if he were the first-mentioned operator.

Revocation, suspension and variation of certificates, licences and other documents

- (a) **81.** (1) (a) Subject to paragraphs (4) and (5), the Governor may, if he thinks fit, provisionally suspend or vary any certificate, licence, approval, permission, exemption, authorisation or other document issued, granted or having effect under this Order, pending inquiry into or consideration of the case.
- (b) The Governor may, on sufficient ground being shown to his satisfaction after due inquiry, revoke, suspend or vary any such certificate, licence, approval, permission, exemption, authorisation or other document.

(2) The holder or any person having the possession or custody of any certificate, licence, approval, permission, exemption or other document which has been revoked, suspended or varied under this Order shall surrender it to the Governor within a reasonable time after being required to do so by the Governor.

(3) The breach of any condition subject to which any certificate, licence, approval, permission, exemption or other document, other than a licence issued in respect of an aerodrome, has been granted or issued or which has effect under this Order, shall, in the absence of provision to the contrary in the document, render the document invalid during the continuance of the breach.

(4) The provisions of article 82 of this Order shall have effect, in place of the provisions of this article, in relation to permissions granted by the Secretary of State or the Governor, as the case may be, under article 113 of this Order and any approvals or authorisations of, or consents to, any matter which the Secretary of State or the Governor has granted, or is deemed to have granted, in pursuance of a permission which he has so granted.

(5) Notwithstanding paragraph (1), a flight manual, performance schedule or other document incorporated by reference in the certificate of airworthiness may be varied on sufficient ground being shown to the satisfaction of the Governor, whether or not after due inquiry.

Revocation, suspension and variation of permissions, etc granted under article 113 or article 115

82.—(1) Subject to the provisions of this article, the Secretary of State may revoke, suspend or vary any permit to which this article applies.

(2) Save as provided by paragraph (3), the Secretary of State, may exercise his powers under paragraph (1) only after notifying the permit-holder of his intention to do so and after due consideration of the case.

(3) If, by reason of the urgency of the matter, it appears to the Secretary of State to be necessary for him to do so, he may provisionally suspend or vary a permit to which this article applies without complying with the requirements of paragraph (2); but he shall in any such case comply with those requirements as soon thereafter as is reasonably practicable and shall then, in the light of his due consideration of the case, either:

- (a) revoke the provisional suspension or variation of the permit; or
- (b) substitute therefor a definitive revocation, suspension or variation, which, if a definitive suspension, may be for the same or a different period as the provisional suspension (if any) or, if a definitive variation, may be in the same or different terms as the provisional variation (if any).

(4) The powers vested in the Secretary of State by paragraph (1) or paragraph (3) may be exercised by him whenever, in his judgement and whether or not by reason of anything done or omitted to be done by the permit-holder or otherwise connected with the permit-holder, it is necessary or expedient that the permit-holder should not enjoy, or should no longer enjoy, the rights conferred on him by a permit to which this article applies or should enjoy them subject to such limitations or qualifications as the Secretary of State may determine. In particular, and without prejudice to the generality of the foregoing, the Secretary of State may exercise his said powers if:

- (a) it appears to him that the person to whom the permit was granted has committed a breach of any condition to which it is subject;
- (b) it appears to him that any agreement between Her Majesty's Government in the United Kingdom and the Government of any other country in pursuance of which or in reliance on which the permit was granted is no longer in force or that that other Government has committed a breach thereof;
- (c) it appears to him that the person to whom the permit was granted, or such other Government as aforesaid (that is to say, a Government which is a party to such an agreement as aforesaid with Her Majesty's Government in the United Kingdom), or the aeronautical authorities of the country concerned, have acted in a manner which is inconsistent with or prejudicial to the operation in good faith, and according to its object and purpose, of any such agreement as aforesaid, or have engaged in unfair discriminatory or restrictive practices to the prejudice of the holder of an Air Transport Licence granted under section 65 of the Civil Aviation Act 1982⁽⁶⁾ as it applies in the United Kingdom or the holder of a route licence granted under that section as applied by section 69A of that Act in his operation of air services to or from points in the country concerned or of the operator of an aircraft registered in and licensed to operate from any of the Territories by regulations under section 13 of the Act in his operation of air services to or from points in the country concerned; and
- (d) it appears to him that the person to whom the permit was granted, having been granted it as a person designated by the Government of a country other than the United Kingdom for the purposes of any such agreement as aforesaid, is no longer so designated or that that person has so conducted himself, or that such circumstances have arisen in relation to him, as to make it necessary or expedient to disregard or qualify the consequences of his being so designated.

(5) The permit-holder or any person having the possession or custody of any permit which has been revoked, suspended or varied under this article shall surrender it to the Secretary of State within a reasonable time of being required by him to do so.

(6) The breach of any condition subject to which any permit to which this article applies has been granted shall render the permit invalid during the continuance of the breach.

(6) 1982 c. 16.

(7) The permits to which this article applies are permissions granted by the Secretary of State or the Governor as the case may be under Article 113 or Article 115 of this Order and any approvals or authorisations of, or consents to, any matter which the Secretary of State or the Governor has granted, or is deemed to have granted, in pursuance of a permission which he has so granted.

(8) References in this Article to the permit-holder are references to the person to whom any permit to which this article applies has been granted or is deemed to have been granted.

(9) The Secretary of State may, in any particular case, or class of cases, delegate to the Governor the exercise of the powers conferred on the Secretary of State under this article in respect of permissions granted by the Secretary of State or the Governor as the case may be under Article 113 of this Order and any approvals or authorisations of, or consents to, any matter which the Secretary of State or the Governor has granted, or is deemed to have granted, in pursuance of a permission which he has so granted.

(10) The provisions of this Article shall have effect, as from the commencement of this Order, as well in relation to permits, being permits to which this Article applies, granted before the commencement of this Order as in relation to those granted thereafter.

Offences in relation to documents and records

83.—(1) A person shall not with intent to deceive:

- (a) use any certificate, licence, approval, permission, exemption or other document issued or required by or under this Order which has been forged, altered, revoked or suspended, or to which he is not entitled;
- (b) lend any certificate, licence, approval, permission, exemption or any other document issued or having effect or required by or under this Order to, or allow it to be used by, any other person; or
- (c) make any false representation for the purpose of procuring for himself or any other person the grant, issue, renewal or variation of any such certificate, licence, approval, permission, exemption or other document;

and in this paragraph a reference to a certificate, licence, approval, permission, exemption or other document includes a copy or purported copy thereof.

(2) A person shall not intentionally damage, alter or render illegible any log book or other record required by or under this Order to be maintained or any entry made therein, or knowingly make, or procure or assist in the making of, any false entry in or material omission from any such log book or record or destroy any such log book or record during the period for which it is required under this Order to be preserved.

(3) All entries made in writing in any log book or record referred to in paragraph (2) shall be made in ink or indelible pencil.

(4) A person shall not knowingly make in a load sheet any entry which is incorrect in any material particular, or any material omission from such a load sheet.

(5) A person shall not purport to issue any certificate for the purpose of this Order, of any regulations made thereunder unless he is authorised to do so under this Order.

(6) A person shall not issue any certificate as aforesaid unless he has satisfied himself that all statements in the certificate are correct.

PART VIII

Movement of Aircraft

Rules of the Air

84.—(1) The Governor may make Rules of the Air supplementary to but not inconsistent with the Rules of the Air in Schedule 13 to this Order.

(2) Subject to the provisions of paragraph (3), it shall be an offence to contravene, to permit the contravention of, or to fail to comply with, the Rules of the Air.

(3) It shall be lawful for the Rules of the Air to be departed from to the extent necessary:

- (a) for avoiding immediate danger;
- (b) for complying with the law of any country other than the Territory within which the aircraft then is; or
- (c) for complying with Military Flying Regulations (Joint Service Publication 318) or Flying Orders to Contractors (Aviation Publication 67) issued by the Secretary of State in relation to an aircraft of which the commander is acting as such in the course of his duty as a member of any of Her Majesty's naval, military or air forces.

(4) If any departure from the Rules of the Air is made for the purpose of avoiding immediate danger, the commander of the aircraft shall cause written particulars of the departure, and of the circumstances giving rise to it, to be given within 10 days thereafter to the competent authority of the country in whose territory the departure was made or if the departure was made over the high seas, to the Governor.

(5) Nothing in the Rules of the Air shall exonerate any person from the consequences of any neglect in the use of lights or signals or of the neglect of any precautions required by ordinary aviation practice or by the special circumstances of the case.

Power to prohibit or restrict flying

(a) **85.** (1) (a) Where the Governor deems it necessary in the public interest to restrict or prohibit flying by reason of:

- (i) the intended gathering or movement of a large number of persons;
- (ii) the intended holding of an aircraft race or contest or of a flying display; or
- (iii) national defence or any other reason affecting the public interest;

the Governor may make regulations prohibiting, restricting or imposing conditions on flight:

- (aa) by any aircraft, whether or not registered in the Territory, in any airspace over the Territory; and
- (bb) by aircraft registered in the Territory, in any other airspace, being airspace in respect of which the Government of the Territory has in pursuance of international arrangements undertaken to provide navigation services for aircraft.

(b) Regulations made under this article may apply either generally or in relation to any class of aircraft.

(2) It shall be an offence to contravene or permit the contravention of or fail to comply with any regulations made hereunder.

(3) If the commander of an aircraft becomes aware that the aircraft is flying in contravention of any regulations which have been made for any of the reasons referred to in paragraph (1)(a)(iii) he shall, unless otherwise instructed pursuant to paragraph (4), cause the aircraft to leave the area to

which the regulations relate by flying to the least possible extent over such area and the aircraft shall not begin to descend while over such an area.

(4) The commander of an aircraft flying either within an area for which regulations have been made for any of the reasons referred to in paragraph (1)(a)(iii) or within airspace notified as a Danger Area shall forthwith comply with instructions given by radio by the appropriate air traffic control unit or by, or on behalf of, the person responsible for safety within the relevant airspace.

Balloons, kites, airships, gliders and parascending parachutes

86.—(1) The provisions of this article shall apply only to or in relation to aircraft within the Territory.

- (a) (2) (a) A balloon in captive or tethered flight shall not be flown within 60 metres of any vessel, vehicle or structure except with the permission of the person in charge of any such vessel, vehicle or structure.
- (b) (i) a glider or parascending parachute shall not be launched by winch and cable or by ground tow to a height or more than 60 metres above ground level;
- (ii) a balloon in captive flight shall not be flown within the aerodrome traffic zone of a notified aerodrome during the notified operating hours of that aerodrome;
- (iii) a balloon in captive or tethered flight shall not be flown at a height measured to the top of the balloon of more than 60 metres above ground level;
- (iv) a kite shall not be flown at a height of more than 30 metres above ground level within the aerodrome traffic zone of a notified aerodrome during the notified operating hours of that aerodrome;
- (v) a kite shall not be flown at a height of more than 60 metres above ground level; and
- (vi) a parascending parachute shall not be launched by winch and cable or by ground tow within the aerodrome traffic zone of a notified aerodrome during the notified operating hours of that aerodrome;

without the permission in writing of the Governor and in accordance with any conditions subject to which that permission may have been granted.

(3) An uncontrollable balloon in captive or released flight shall not be flown in airspace notified for the purposes of this paragraph without the permission in writing of the Governor and in accordance with any conditions subject to which that permission may have been granted.

(4) A controllable balloon shall not be flown in free controlled flight:

- (a) within airspace notified for the purposes of this paragraph; or
- (b) within the aerodrome traffic zone of a notified aerodrome during the notified operating hours of that aerodrome;

except during the day and in visual meteorological conditions.

(5) A controllable balloon shall not be flown in tethered flight:

- (a) within airspace notified for the purposes of this paragraph; or
- (b) within the aerodrome traffic zone of a notified aerodrome;

except with the permission of the appropriate air traffic control unit and in accordance with any conditions subject to which that permission may have been granted.

(6) A balloon when in captive flight shall be securely moored and shall not be left unattended unless it is fitted with a device which ensures its automatic deflation if it breaks free of its moorings.

(7) An airship with a capacity exceeding 3,000 cubic metres shall not be moored other than at a notified aerodrome except with the permission in writing of the Governor and in accordance with any conditions subject to which that permission may have been granted.

(8) An airship with a capacity not exceeding 3,000 cubic metres, unless it is moored on a notified aerodrome, shall not be moored:

- (a) within 2 km of a congested area; or
- (b) within the aerodrome traffic zone of a notified aerodrome except with the permission in writing of the Governor and in accordance with any conditions subject to which that permission may have been granted.

(9) An airship when moored in the open shall be securely moored and shall not be left unattended.

(a) (10) (a) A person shall not cause or permit a group of small balloons exceeding 1,000 in number to be simultaneously released at a single site wholly or partly within the aerodrome traffic zone of a notified aerodrome during the notified operating hours of that aerodrome unless that person has given to the Governor not less than 28 days previous notice in writing of the release.

(b) A person shall not cause or permit a group of small balloons exceeding 2,000 but not exceeding, 10,000 in number to be simultaneously released at a single site:

(i) within airspace notified for the purposes of this sub-paragraph without the permission in writing of the Governor; or

(ii) within the aerodrome traffic zone of a notified aerodrome during the notified operating hours of that aerodrome without the permission in writing of the Governor; in either case other than in accordance with any conditions subject to which such a permission may have been granted.

(c) A person shall not cause or permit a group of small balloons greater than 10,000 in number to be simultaneously released at a single site except with the permission in writing of the Governor and in accordance with any conditions subject to which such a permission may have been granted.

(d) For the purposes of sub-paragraphs (a), (b) and (c) “simultaneously released at a single site” shall mean the release of a specified number of balloons during a period not exceeding 15 minutes from within an area not exceeding 1 km square.

(11) For the purposes of this article “a notified aerodrome” is an aerodrome notified for the purposes of rule 39 of the Rules of the Air and the “notified operating hours” means the times notified in respect of an aerodrome during which that rule applies.

Regulation of small aircraft

87.—(1) A person shall not cause or permit any article or animal (whether or not attached to a parachute) to be dropped from a small aircraft so as to endanger persons or property.

(2) The person in charge of a small aircraft which weighs more than 7 kg without its fuel but including any articles of equipment installed in or attached to the aircraft at the commencement of its flight shall not fly such an aircraft:

- (a) unless the person in charge of the aircraft has reasonably satisfied himself that the flight can safely be made;
- (b) in Class A, C, D or E airspace unless the permission of the appropriate air traffic control unit has been obtained;
- (c) within an aerodrome traffic zone during the notified hours of watch of the air traffic control unit (if any) at that aerodrome unless the permission of any such air traffic control unit has been obtained;

- (d) at a height exceeding 400 ft above the surface unless it is flying in airspace described in sub-paragraphs (b) or (c) and in accordance with the requirements thereof; or
- (e) for aerial work purposes other than in accordance with a permission issued by the Governor which may be issued subject to such conditions as the Governor thinks fit.

PART IX

Air Traffic Services

Requirement for approval for the provision of air traffic services

88. No person in charge of the provision of an air traffic control service shall provide such a service otherwise than under and in accordance with the terms of an approval granted to him by the Governor, and the Governor shall grant an approval if he is satisfied that the applicant is competent, having regard to his organisation, staffing, equipment, maintenance and other arrangements, to provide a service which is safe for use by aircraft.

Manual of Air Traffic Services

- 89.** A person shall not provide an air traffic control service at any place unless:
- (a) the service is provided in accordance with the standards and procedures specified in a manual of air traffic services in respect of that place;
 - (b) the manual is produced to the Governor within a reasonable time after a request for its production is made by the Governor; and
 - (c) such amendments or additions have been made to the manual as the Governor may from time to time require.

Provision of air traffic services

90.—(1) In the case of an aerodrome (other than a Government aerodrome) in respect of which there is equipment for providing holding aid, let-down aid or approach aid by radio or radar, the person in charge of the aerodrome shall:

- (a) inform the Governor in advance of the periods during and times at which any such equipment is to be in operation for the purpose of providing such aid as is specified by the said person; and
- (b) during any period and at such times as are notified, cause an approach control service to be provided.

(2) The Governor may direct that there shall be provided in respect of any aerodrome (other than a Government aerodrome) such air traffic control service, aerodrome flight information service or means of two-way radio communication as the Governor considers appropriate in respect thereof. The Governor may specify in the direction the periods during and the times at which such a service or such means shall be provided and the person in charge of the aerodrome shall cause such a service or such means to be provided in accordance with any such direction.

(3) Obligations to cause an air traffic control service to be provided arising under paragraph (1) or (2) are without prejudice to each other.

Use of radio call signs at aerodromes

91. The person in charge of an aerodrome provided with means of two-way radio communication shall not cause or permit any call sign to be used for a purpose other than a purpose for which that call sign has been notified.

Licensing of air traffic controllers and student air traffic controllers

(a) **92.** (1) (a) Subject to sub-paragraph (b), the Governor shall grant a licence subject to such conditions as he thinks fit to any person to act as an air traffic controller or as a student air traffic controller upon his being satisfied that the applicant is a fit person to hold the licence and is qualified by reason of his knowledge, experience, competence, skill and physical and mental fitness so to act, and for that purpose the applicant shall furnish such evidence and undergo such examinations and tests (including in particular medical examinations) and undertake such courses of training, as the Governor may require of him.

(b) The Governor shall not grant:

- (i) a student air traffic controller's licence to any person under the age of 18 years; or
- (ii) an air traffic controller's licence to any person under the age of 20 years.

(a) (2) (a) Subject to article 81 of this Order, a licence to act as an air traffic controller or a student air traffic controller shall remain in force for the period indicated in the licence and may be renewed by the Governor from time to time, upon his being satisfied that the applicant is a fit person and is qualified as aforesaid.

(b) If no period is indicated in the licence, it shall remain in force, subject as aforesaid, for the lifetime of the holder.

(3) The Governor may include in an air traffic controller's licence, subject to such conditions as he thinks fit and upon his being satisfied that the applicant is qualified as aforesaid to act in the capacity to which the rating relates, a rating of any of the classes set forth in Schedule 9 to this Order specifying the type of air traffic control service which the holder of the licence is competent to provide and such a rating shall be deemed to form part of the licence.

(a) (4) (a) The holder of an air traffic controller's licence shall not be entitled to exercise the privileges of a rating contained in the licence at any place for any sector or with any type of radar equipment unless the licence includes a valid certificate of competence in respect of that rating which is appropriate to that place or sector and that equipment (if any) which certificate complies with sub-paragraph (b).

(b) A valid certificate of competence shall not be appropriate to the exercise of the privileges of a rating at any place or for any sector or with any type of radar equipment unless the certificate:

- (i) specifies that place or sector and that type of radar equipment (if any) with the aid of which the services is to be provided;
- (ii) certifies that the person signing the certificate is satisfied that on a date specified in the certificate the holder of the licence, of which the certificate forms part, has passed an appropriate test of his ability to exercise the privileges of the rating at the place or for the sector and with the type or radar equipment, if any, specified in the certificate; and

(iii) specifies the date on which it was signed.

(c) (i) A valid certificate of competence shall be signed by a person authorised by the Governor to sign certificates of that kind.

(ii) A certificate of competence shall be valid, subject to paragraph (2), for 13 months after the date of the test which it certifies.

- (a) (5) (a) If throughout any period of 90 days the holder of a licence has not at any time provided at a particular place or for a particular sector and with the aid of the type of radar equipment, if any, specified in a certificate of competence, the type of air traffic control service specified in the rating to which the certificate of competence relates, the certificate shall, without prejudice to the Governor's powers under article 81 of this Order, cease to be valid for that place or sector at the end of that period.
- (b) Upon a certificate of competence ceasing to be valid for a place or sector the holder of the licence shall forthwith inform the person who is approved pursuant to article 88 of this Order to provide an air traffic control service at that place or for that sector to that effect and shall forward the licence to a person approved by the Governor for the purpose who shall endorse the licence accordingly and return it to the holder forthwith.
- (6) Every licence to act as a student air traffic controller shall be valid only for the purpose of authorising the holder to act as an air traffic controller under the supervision of another person who is present at the time and who is the holder of an air traffic controller's licence entitling him to provide unsupervised the type of air traffic control service which is being provided by the student air traffic controller and who is approved by the Governor for this purpose.
- (7) A licence to act as an air traffic controller or a student air traffic controller shall not be valid unless the holder of the licence has signed his name thereon in ink with his ordinary signature.
- (8) Every holder of an air traffic controller's licence or a student air traffic controller's licence shall, upon such occasions as the Governor may require, submit himself to such examinations and tests (including in particular medical examinations) and furnish such evidence as to his knowledge, experience, competence and skill and undergo such courses of training as the Governor may require.
- (9) On the basis of the medical examination referred to in paragraph (8), the Governor or any person approved by him as competent to do so may issue a medical certificate subject to such conditions as he thinks fit to the effect that the holder of the licence has been assessed as fit to perform the functions to which the licence relates. The certificate shall, subject to article 95 of this Order, be valid for such period as is therein specified, and shall be deemed to form part of the licence.
- (a) (10) (a) The holder of an air traffic controller's licence shall not act as an air traffic controller unless his licence includes a medical certificate issued and in force under paragraph (9).
- (b) The holder of a student air traffic controller's licence shall not act in accordance with paragraph (6) unless his licence includes a medical certificate issued and in force under paragraph (9).
- (11) For the purpose of this Part of this Order and Schedule 9 thereto, "acting as an air traffic controller" shall mean the giving of instructions or advice or both instructions and advice by means of radio signals (whether directly or indirectly via a person acting in accordance with article 94(3) of this Order) to aircraft in the interests of safety.

Approval of courses and persons

93. Without prejudice to any other provision of this Order the Governor may, for the purposes of this Part of this Order, either absolutely or subject to such conditions as he thinks fit:

- (a) approve any course of training or instruction;
- (b) authorise a person to conduct such examinations or tests as he may specify; and
- (c) approve a person to provide any course of training or instruction.

Prohibiting of unlicensed air traffic controllers and student air traffic controllers

94.—(1) Subject to paragraphs (3), (4) and (5), a person shall not act as an air traffic controller or hold himself out, whether by use of a radio call sign or in any other way, as a person who may so act unless he is the holder of, and complies with the terms of:

- (a) a valid student air traffic controller's licence granted under this Order and he is supervised in accordance with article 92(6) or this Order;
- (b) a valid air traffic controller's licence so granted authorising him to provide that type of service at that place or for that sector and with the type of radar equipment being used (if any); or
- (c) a valid air traffic controller's licence so granted which does not authorise him to provide that type of service at that place or for that sector and with the type of radar equipment being used (if any) but he is supervised as though he was the holder of a student air traffic controller's licence.

(2) A person shall not act as an air traffic controller unless he has identified himself in such a manner as may be notified.

(3) A licence shall not be required by any person who, acting in the course of his employment, passes on such instructions or advice as he has been instructed so to do by the holder of an air traffic controller's licence which entitles that holder to give such instructions or advice.

(4) Nothing in this article shall prohibit the holder of a valid air traffic controller's licence from providing at any place or for any sector for which the licence includes a valid certificate of competence, information to aircraft in flight in the interests of safety.

(5) A licence shall not be required by any person who acts in the course of his duty as a member of any of Her Majesty's naval, military or air forces or a visiting force.

Incapacity of air traffic controllers

95.—(1) Every holder of an air traffic controller's licence granted under article 92 of this Order who:

- (a) suffers any personal injury or illness involving incapacity to undertake the functions to which his licence relates throughout a period of 20 consecutive days; or
- (b) in the case of a woman, has reason to believe that she is pregnant;

shall inform the Governor in writing of such injury, illness or pregnancy as soon as possible.

(2) An air traffic controller's licence shall be deemed to be suspended on the expiry of the period of injury or illness referred to in paragraph (1)(a). The suspension of the licence shall cease:

- (a) upon the holder being medically examined under arrangements made by the Governor and pronounced fit to resume his functions under the licence; or
- (b) upon the Governor exempting the holder from the requirement of a medical examination subject to such conditions as the Governor may think fit.

Prohibition of drunkenness etc. of controllers

96. A person shall not when exercising the privileges of an air traffic controller's licence be under the influence of drink or a drug to such an extent as to impair his capacity to exercise such privileges.

Fatigue of air traffic controllers-air traffic controllers' responsibilities

97. A person holding an air traffic controller's licence shall not act as an air traffic controller if he knows or suspects that he is suffering from or, having regard to the circumstances of the period

of duty to be undertaken, is likely to suffer from, such fatigue as may endanger the safety of any aircraft to which an air traffic control service may be provided.

Licensing of flight information service officers

- (a) **98.** (1) (a) Subject to sub-paragraph (b), the Governor shall grant a licence subject to such conditions as he thinks fit to any person to act as a flight information service officer upon his being satisfied that the applicant is a fit person to hold the licence and is qualified by reason of his knowledge, experience, competence, skill and physical and mental fitness so to act, and for that purpose the applicant shall furnish such evidence and undergo such examinations and tests and undertake such courses of training as the Governor may require of him.
- (b) The Governor shall not grant such a licence to any person under the age of 18 years.
- (2)
 - (a) (2) (a) Subject to article 81 of this Order, a licence to act as a flight information service officer shall remain in force for the period indicated in the licence and may be renewed by the Governor from time to time, upon his being satisfied that the applicant is a fit person and is qualified as aforesaid.
 - (b) If no period is indicated in the licence it shall remain in force, subject as aforesaid, for the lifetime of the holder.
 - (a) (3) (a) The holder of a flight information service officer's licence shall not be entitled to provide a flight information service at an aerodrome or area control centre unless that aerodrome or area control centre has been specified in the licence by a person authorised by the Governor for the purpose and the licence has been validated in respect of that aerodrome or area control centre by a person authorised for the purpose by the Governor.
 - (b) If, throughout any period of 90 days the holder of the licence has not at any time provided such a service at a particular aerodrome or area control centre, the licence shall cease to be valid for that aerodrome or area control centre at the end of that period until the licence has been revalidated in respect of that aerodrome or area control centre by a person authorised by the Governor for the purpose.
- (4) A licence to act as a flight information service officer shall not be valid unless the holder of the licence has signed his name thereon in ink with his ordinary signature.
- (5) Every holder of a flight information service officer's licence shall upon such occasions as the Governor may require, submit himself to such examinations and tests and furnish such evidence as to his knowledge, experience, competence and skill and undergo such courses of training as the Governor may require.

Prohibition of unlicensed flight information service officers

- 99.**—(1) A person shall not provide at any aerodrome or area control centre a flight information service or hold himself out, whether by use of a radio call sign or in any other way, as a person who may provide such a service unless he is the holder of and complies with the terms of a flight information service officer's licence granted under this Order authorising him to provide such a service at that aerodrome or area control centre.
- (2) A person shall not provide a flight information service unless he has identified himself in such a manner as may be notified.

Flight information service manual

100. A person shall not provide a flight information service at any aerodrome or area control centre unless:

- (a) the service is provided in accordance with the standards and procedures specified in a flight information service manual in respect of that aerodrome or area control centre;
- (b) the manual is produced to the Governor within a reasonable time after a request for its production is made by the Governor; and
- (c) such amendments or additions have been made to the manual as the Governor may from time to time require.

PART X

Aerodromes, Aeronautical Lights and Dangerous Lights

Aerodromes-public transport of passengers and instruction in flying

101.—(1) An aircraft to which this paragraph applies shall not take off or land at a place in the Territory other than:

- (a) an aerodrome licensed under this Order for the take-off and landing of such aircraft; or
- (b) a Government aerodrome notified as available for the take-off and landing of such aircraft, or in respect of which the person in charge of the aerodrome has given his permission for the particular aircraft to take off or land as the case may be;

and in accordance with any conditions subject to which the aerodrome may have been licensed or notified, or subject to which such permission may have been given.

(2) Subject to paragraph (3), paragraph (1) applies to:

- (a) aeroplanes of which the maximum total weight authorised exceeds 2,730 kg, and which are flying:
 - (i) for the purpose of the public transport of passengers;
 - (ii) for the purpose of instruction in flying given to any person for the purpose of becoming qualified for the grant of a pilot's licence or the inclusion of an aircraft rating, a night rating or a night qualification in a licence; or
 - (iii) for the purpose of carrying out flying tests in respect of the grant of a pilot's licence or the inclusion of an aircraft rating or a night rating in a licence;
- (b) aeroplanes of which the maximum total weight authorised does not exceed 2,730 kg engaged on either:
 - (i) scheduled journeys for the purpose of the public transport of passengers;
 - (ii) flights for the purpose of the public transport of passengers beginning and ending at the same aerodrome;
 - (iii) flights for the purpose of:
 - (aa) instruction in flying given to any person for the purpose of becoming qualified for the grant of a pilot's licence or the inclusion of an aircraft rating, a night rating or a night qualification in a licence; or
 - (bb) a flying test in respect of the grant of a pilot's licence or the inclusion of an aircraft rating, a night rating or a night qualification in a licence; or
 - (iv) flights for the purpose of the public transport of passengers at night;

- (c) helicopters and gyroplanes engaged on such flights as are specified in sub-paragraphs (b) (i) and (iii); and
 - (d) gliders (other than gliders being flown under arrangements made by a flying club and carrying no person other than a member of the club) which are flying for the purpose of the public transport of passengers or for the purpose of instruction in flying.
- (3) Nothing in paragraph (1) shall apply to or in relation to an aircraft flying under and in accordance with the terms of a police air operator's certificate.
- (a) (4) (a) Subject to sub-paragraph (c), the person in charge of any area in the Territory intended to be used for the taking off or landing of helicopters at night other than such a place as is specified in paragraph (1) shall cause to be in operation, whenever a helicopter flying for the purpose of the public transport of passengers is taking off or landing at that area by night, such lighting as will enable the pilot of the helicopter:
 - (i) in the case of landing, to identify the landing area in flight, to determine the landing direction and to make a safe approach and landing; and
 - (ii) in the case of taking off, to make a safe take-off.
 - (b) Subject to sub-paragraph (c), a helicopter flying for the purpose of the public transport of passengers at night shall not take off or land at a place to which sub-paragraph (a) applies unless there is in operation such lighting.
 - (c) Nothing in this paragraph shall apply to or in relation to an aircraft flying under and in accordance with the terms of a police air operator's certificate.

Use of Government aerodromes

102. The Governor may cause to be notified, subject to such conditions as he thinks fit, any Government aerodrome as an aerodrome available for the take-off and landing of aircraft engaged on flights for the purpose of the public transport of passengers or for the purpose of instruction in flying or of any classes of such aircraft.

Licensing of aerodromes

103.—(1) The Governor shall grant a licence in respect of any aerodrome in the Territory if he is satisfied that:

- (a) the applicant is competent, having regard to his previous conduct and experience, his equipment, organisation, staffing, maintenance and other arrangements, to secure that the aerodrome and the airspace within which its visual traffic pattern is normally contained are safe for use by aircraft;
- (b) the aerodrome is safe for use by aircraft, having regard in particular to the physical characteristics of the aerodrome and of its surroundings; and
- (c) the aerodrome manual submitted pursuant to paragraph (7) is adequate.

(2) An aerodrome licence may be granted subject to such conditions as the Governor thinks fit and shall, subject to article 81 of this Order, remain in force for the period specified in the licence.

(3) Without prejudice to the generality of paragraph (2), if the applicant so requests the Governor may grant a licence (in this Order referred to as "a licence for public use") which shall be subject to the condition that the aerodrome shall at all times when it is available for the take-off or landing of aircraft be so available to all persons on equal terms and conditions.

(4) The holder of an aerodrome licence granted under this Order (in this article called "an aerodrome licence holder") shall:

- (a) furnish to any person on request information concerning the terms of the licence; and

(b) in the case of a licence for public use, cause to be notified the time during which the aerodrome will be available for the take-off or landing of aircraft engaged on flights for the purpose of the public transport of passengers or instruction in flying.

(5) The holder of an aerodrome licence granted under this Order shall not contravene or cause or permit to be contravened any condition of the aerodrome licence at any time in relation to such aircraft engaged on such flights as are specified in article 101(2) of this Order, but the licence shall not cease to be valid by reason only of such a contravention.

(6) An aerodrome licence holder shall take all reasonable steps to secure that the aerodrome and the airspace within which its visual traffic pattern is normally contained are safe at all times for use by aircraft.

(7) Upon making an application for an aerodrome licence the applicant shall submit to the Governor an aerodrome manual for that aerodrome.

(8) An aerodrome manual required pursuant to this article shall contain all such information and instructions as may be necessary to enable the aerodrome operating staff to perform their duties as such including, in particular, information and instructions relating to the matters specified in Schedule 16 to this Order.

(9) Every aerodrome licence holder shall:

- (a) furnish to the Governor any amendments or additions to the aerodrome manual before or immediately after they come into effect;
- (b) without prejudice to sub-paragraph (a), make such amendments or additions to the aerodrome manual as the Governor may require for the purpose of ensuring the safe operation of aircraft at the aerodrome or the safety of air navigation; and
- (c) maintain the aerodrome manual and make such amendments as may be necessary for the purpose of keeping its contents up to date.

(10) (a) Every aerodrome licence holder shall make available to each member of the aerodrome operating staff a copy of the aerodrome manual, or a copy of every part of the aerodrome manual which is relevant to his duties and shall ensure that each such copy is kept up to date.

(b) Every aerodrome licence holder shall take all reasonable steps to secure that each member of the aerodrome operating staff:

(i) is aware of the contents of every part of the aerodrome manual which is relevant to his duties as such; and

(ii) undertakes his duties as such in conformity with the relevant provisions of the manual.

(11) For the purposes of this article:

(a) “aerodrome operating staff” means all persons, whether or not the aerodrome licence holder and whether or not employed by the aerodrome licence holder, whose duties are concerned either with ensuring that the aerodrome and airspace within which its visual traffic pattern is normally contained are safe for use by aircraft, or whose duties require them to have access to the aerodrome manoeuvring area or apron;

(b) “visual traffic pattern” means the aerodrome traffic zone of the aerodrome, or, in the case of an aerodrome which is not notified for the purposes of rule 39 of the Rules of the Air, the airspace which would comprise the aerodrome traffic zone of the aerodrome if it was so notified.

Aeronautical radio station

104.—(1) A person shall not cause or permit any aeronautical radio station to be established or used unless its purpose has been approved by the Governor and the equipment thereof is of a type the specification of which is approved by the Governor in relation to the purpose for which it is to be used.

(a) (2) (a) Subject to sub-paragraph (b), the person in charge of an aeronautical radio station the purpose of which is to provide a navigational aid by radio or radar to an aircraft making an approach to land or landing at an aerodrome, shall not cause or permit that aeronautical radio station to provide such navigational aid unless all aeronautical radio stations operated by that person at that aerodrome are:

(i) installed, modified and maintained in a manner approved by the Governor; and

(ii) flight checked by the Governor or by a person approved by the Governor for that purpose on such occasions as the Governor may require.

(b) The provisions of this paragraph shall not apply to any aeronautical radio station which is used solely for the purpose of enabling communications to be made by or on behalf of the operator of an aircraft and the commander thereof.

(3) The person in charge of an aeronautical radio station at an aerodrome for which a licence for public use has been granted shall cause to be notified in relation to that aeronautical radio station the type and hours of operation of any service which is available for use by any aircraft, and in approving the purpose for which an aeronautical radio station is to be used at any other aerodrome the Governor may if he thinks fit require the person in charge of the aeronautical radio station to cause such information as aforesaid to be notified.

(4) For the purpose of this article an approval shall be in writing and may be granted subject to such conditions as the Governor thinks fit.

(5) The provisions of this article shall not apply in respect of any aeronautical radio station of which the person in charge is the Governor.

Aeronautical radio station records

105.—(1) The person in charge of any aeronautical radio station, the purpose of which is to provide navigational aid by radio or radar to an aircraft making an approach to land or landing at an aerodrome, shall in respect of all aeronautical radio stations operated by him at that aerodrome:

(a) keep a written record of functional tests, flight checks and particulars of any overhaul, repair, replacement or modification thereof; and

(b) preserve the written record for a period of one year or such longer period as the Governor may in a particular case direct and shall within a reasonable time after being requested to do so by an authorised person produce such record to that person.

(2) The person in charge of an aeronautical radio station which is used for the provision of an air traffic control service by an air traffic control unit shall provide apparatus which is capable of recording the terms of content of any radio message or signal transmitted to any aircraft either alone or in common with other aircraft or received from any aircraft by the air traffic control unit.

(3) The apparatus provided in compliance with paragraph (2) shall be:

(a) of a type the specification of which is approved by the Governor in relation to the particular aeronautical radio station;

(b) installed, modified and maintained in a manner approved by the Governor; and

(c) in operation at all times when the aeronautical radio station is in operation for providing an air traffic control service;

and for the purpose of this article an approval shall be in writing and may be granted subject to such conditions as the Governor thinks fit.

(4) The person in charge of an aeronautical radio station shall ensure that each record made by the apparatus provided in compliance with paragraph (2) includes:

- (a) the identification of the aeronautical radio station;
- (b) the date or dates on which the record was made;
- (c) a means of determining the time at which each message or signal was transmitted;
- (d) the identity of the aircraft to or from which and the radio frequency on which the message or signal was transmitted or received; and
- (e) the time at which the record started and finished.

(5) If at any time the apparatus provided in compliance with paragraph (2) ceases to be capable of recording the matters required by this article to be included in the record the person in charge of the aeronautical radio station shall ensure that a written record is kept in which the particulars specified in paragraph (4) are recorded together with a summary of communications exchanged between the aeronautical radio station and aircraft.

(6) The person in charge of the aeronautical radio station shall preserve any record made in compliance with paragraphs (2) and (5) for a period of 30 days from the date on which the message or signal was recorded or for such longer period as the Governor may in a particular case direct, and shall, within a reasonable time after being requested to do so by an authorised person, produce such record to that person.

- (a) (7) (a) Subject to sub-paragraph (b), a person required by this article to preserve any record by reason of his being the person in charge of the aeronautical radio station shall, if he ceases to be such a person, continue to preserve the record as if he had not ceased to be such a person, and in the event of his death the duty to preserve the record shall fall upon his personal representative.
- (b) If another person becomes the person in charge of the aeronautical radio station the previous person in charge or his personal representative shall deliver the record to that other person on demand, and it shall be the duty of that person to deal with the record delivered to him as if he were that previous person in charge.

(8) The provisions of this article shall not apply in respect of any aeronautical radio station of which the person in charge is the Governor.

Charges at aerodromes licensed for public use

106.—(1) The Governor may, in relation to any aerodrome in respect of which a licence for public use has been granted, or to such aerodromes generally or to any class thereof, prescribe the charges, or the maximum charges, which may be made for the use of the aerodrome and for any services performed at the aerodrome to or in connection with aircraft, and may further prescribe the conditions to be observed in relation to those charges and the performance of those services.

(2) The licensee of an aerodrome in relation to which the Governor has made any regulations under paragraph (1) of this article shall not cause or permit any charges to be made in contravention of those regulations and shall cause particulars of the prescribed charges to be kept exhibited at the aerodrome in such a place and manner as to be readily available for the information of any person affected thereby.

(3) The licensee of any aerodrome in respect of which a licence for public use has been granted shall, when required by the Governor, furnish to the Governor such particulars as he may require of the charges established by the licensee for the use of the aerodrome or of any facilities provided at the aerodrome for the safety, efficiency or regularity of air navigation.

Use of aerodromes by aircraft of Contracting States and of the Commonwealth

107. The person in charge of any aerodrome in the Territory which is open to public use by aircraft registered in the Territory (whether or not the aerodrome is a licensed aerodrome) shall cause the aerodrome, and all air navigation facilities provided thereat, to be available for use by aircraft registered in other Contracting States or in any part of the Commonwealth on the same terms and conditions as for use by aircraft registered in the Territory.

Noise and vibration caused by aircraft on aerodromes

108. The conditions under which noise and vibration may be caused by aircraft (including military aircraft) on Government aerodromes, licensed aerodromes or on aerodromes at which the manufacture, repair or maintenance of aircraft is carried out by persons carrying on business as manufacturers or repairers of aircraft shall be as specified in regulation 14 in Schedule 14 to this Order and section 41(2) of the Act as set out in Schedule 2 of the Civil Aviation Act 1949 (Overseas Territories) Order 1969(7) shall apply to any such aerodrome.

Aeronautical lights

109.—(1) Except with the permission of the Governor and in accordance with any conditions subject to which the permission may be granted, a person shall not establish, maintain or alter the character of:

- (a) (i) subject to sub-paragraph (ii), an aeronautical beacon within the Territory;
- (ii) in the case of an aeronautical beacon which is or may be visible from the waters within an area of a general lighthouse authority, the Governor shall not give his permission for the purpose of this article except with the consent of that authority; or
- (b) any aeronautical ground light (other than an aeronautical beacon) at an aerodrome licensed under this Order, or which forms part of the lighting system for use by aircraft taking off from or landing at such an aerodrome.

(2) A person shall not intentionally or negligently damage or interfere with any aeronautical ground light established by or with the permission of the Governor.

Dangerous lights

110.—(1) A person shall not exhibit in the Territory any light which:

- (a) by reason of its glare is liable to endanger aircraft taking off from or landing at an aerodrome; or
- (b) by reason of its liability to be mistaken for an aeronautical ground light is liable to endanger aircraft.

(2) If any light which appears to the Governor to be such a light as aforesaid is exhibited the Governor may cause a notice to be served upon the person who is the occupier of the place where the light is exhibited or has charge of the light, directing that person, within a reasonable time to be specified in the notice, to take such steps as may be specified in the notice for extinguishing or screening the light and for preventing for the future the exhibition of any other light which may similarly endanger aircraft.

(3) The notice may be served either personally or by post, or by affixing it in some conspicuous place near to the light to which it relates.

(4) In the case of a light which is or may be visible from any waters within the area of a general lighthouse authority, the power of the Governor under this article shall not be exercised except with the consent of that authority.

Customs and Excise airports

111.—(1) The Governor may, subject to such conditions as he may think fit, by order designate any aerodrome to be a place for the landing or departure of aircraft for the purpose of the enactments for the time being in force relating to customs and excise.

(2) The Governor may by order revoke any designation so made.

Aviation fuel at aerodromes

112.—(1) Subject to paragraph (2), a person who has the management of any aviation fuel installation on an aerodrome in the Territory shall not cause or permit any fuel to be delivered to that installation or from it to an aircraft unless:

- (a) when the aviation fuel is delivered into the installation he is satisfied that:
 - (i) the installation is capable of storing and dispensing the fuel so as not to render it unfit for use in aircraft;
 - (ii) the installation is marked in a manner appropriate to the grade of fuel stored or if different grades are stored in different parts each part is so marked; and
 - (iii) in the case of delivery into the installation or part thereof from a vehicle or vessel, the fuel has been sampled and is of a grade appropriate to that installation or that part of the installation as the case may be and is fit for use in aircraft;
- (b) when any aviation fuel is dispensed from the installation he is satisfied as the result of sampling that the fuel is fit for use in aircraft.

(2) Paragraph (1) shall not apply in respect of fuel which has been removed from an aircraft and is intended for use in another aircraft operated by the same operator as the aircraft from which it has been removed.

(3) A person to whom paragraph (1) applies shall keep a written record in respect of each installation of which he has the management, which record shall include:

- (a) particulars of the grade and quantity of aviation fuel delivered and the date of delivery;
- (b) particulars of all samples taken of the aviation fuel and of the results of tests of those samples; and
- (c) particulars of the maintenance and cleaning of the installation;

and he shall preserve the written record for a period of 12 months or such longer period as the Governor may in a particular case direct and shall, within a reasonable time after being requested to do so by an authorised person, produce such record to that person.

- (a) (4) (a) A person shall not cause or permit any aviation fuel to be dispensed for use in an aircraft if he knows or has reason to believe that the aviation fuel is not fit for use in aircraft.
- (b) If it appears to the Governor or an authorised person that any aviation fuel is intended or likely to be delivered in contravention of any provision of this article, the Governor or that authorised person may direct the person having the management of the installation not to permit aviation fuel to be dispensed from that installation until the direction has been revoked by the Governor or by an authorised person.

(5) For the purpose of this article:

“aviation fuel” means fuel intended for use in aircraft;

“aviation fuel installation” means any apparatus or container, including a vehicle, designed, manufactured or adapted for the storage of aviation fuel or for the delivery of such fuel to an aircraft.

PART XI

General

Restriction with respect to carriage for valuable consideration in aircraft registered outside the Territory

113.—(1) Notwithstanding anything in any regulations made under Section 13 of the Act, an aircraft registered in a Contracting State, other than the United Kingdom or any of the Territories, or in a foreign country, shall not take on board or discharge any passengers or cargo in the Territory, being passengers or cargo carried or to be carried for valuable consideration, except with the permission of the Secretary of State granted under this article to the operator or charterer of the aircraft or to the Government of the country in which the aircraft is registered, and in accordance with any conditions to which such permission may be subject.

(2) Without prejudice to the provisions of Article 81 or 82 of this Order or of paragraph (1), any breach by a person to whom a permission has been granted under this article of any condition to which that permission was subject shall constitute a contravention of this article.

(3) The Secretary of State may, in any particular case, or class of cases, delegate to the Governor the exercise of the powers conferred on the Secretary of State under paragraph (1); and where the exercise of the powers conferred under paragraph (1) is so delegated, the Governor shall, in exercising those powers, comply with any general guidelines or specific directions which may from time to time be conveyed to him by the Secretary of State.

Filing and approval of tariffs

114.—(1) Where a permission granted under this article contains a tariff provision, the Secretary of State may, in any particular case or class of cases, delegate to the Governor the exercise of the power to approve or disapprove the tariff which the operator or charterer of the aircraft concerned proposes to apply on flights to which the permission relates, and where the power to approve or disapprove tariffs is so delegated, the Governor shall, in exercising that power, comply with any general guidelines or specific directions which may from time to time be conveyed to him by the Secretary of State.

(2) For the purposes of this article, “tariff provision” means a condition as to any of the following matters:

- (a) the price to be charged for the carriage of passengers, baggage or cargo on flights to which a permission granted under article 113(1) of this Order relates;
- (b) any additional goods, services or other benefits to be provided in connection with such carriage;
- (c) the prices, if any, to be charged for any such additional goods, services or benefits; and
- (d) the commission, or rates of commission, to be paid in relation to the carriage of passengers, baggage or cargo;

and includes any condition as to the applicability of any such price, the provision of any such goods, services or benefits or the payment of any such commission or of commission at any such rate.

Restriction with respect to aerial photography, aerial survey and aerial work in aircraft registered outside the Territory

115.—(1) An aircraft registered in a Contracting State other than the United Kingdom or any of the Territories, or in a foreign country, shall not fly over the Territory for the purpose of aerial photography or aerial survey (whether or not valuable consideration is given or promised in respect of the flight or the purpose of the flight) or for the purpose of any other form of aerial work except with the permission of the Governor granted under this article to the operator or the charterer of the aircraft and in accordance with any conditions to which such permission may be subject.

(2) Without prejudice to article 81 or 82 of this Order or to paragraph (1), any breach by a person to whom a permission has been granted under this article of any condition to which that permission was subject shall constitute a contravention of this article.

Flights over any foreign country

116.—(1) The operator or commander of an aircraft registered in the Territory (or, if the operator's principal place of business or permanent residence is in the Territory, any other aircraft) which is being flown over any foreign country shall not allow that aircraft to be used for a purpose which is prejudicial to the security, public order or public health of, or to the safety of air navigation in relation to, that country.

(2) A person does not contravene paragraph (1) if he neither knew nor suspected that the aircraft was being or was to be used for a purpose referred to in paragraph (1).

(3) The operator or commander of an aircraft registered in the Territory (or, if the operator's principal place of business or permanent residence is in the Territory, any other aircraft) which is being flown over any foreign country shall comply with any directions given by the appropriate aeronautical authorities of that country whenever:

- (a) the flight has not been duly authorised; or
- (b) there are reasonable grounds for the appropriate aeronautical authorities to believe that the aircraft is being or will be used for a purpose which is prejudicial to the security, public order or public health of, or to the safety of air navigation in relation to, that country;

unless the lives of persons on board or the safety of the aircraft would thereby be endangered.

(4) A person does not contravene paragraph (3) if he neither knew nor suspected that directions were being given by the appropriate aeronautical authorities.

(5) The requirement in paragraph (3) is without prejudice to any other requirement to comply with directions of an aeronautical authority.

(6) In this article "appropriate aeronautical authorities" includes any person, whether a member of a country's military or civil authorities, authorised under the law of the foreign country to issue directions to aircraft flying over that country.

Mandatory reporting

117.—(1) Subject to the provisions of this article, every person who:

- (a) is the operator or commander of:
 - (i) a public transport aircraft registered in the Territory;
 - (ii) a public transport aircraft not registered in the Territory but operated by the holder of an aircraft operator's certificate granted by the Governor; or
 - (iii) an aircraft registered in the Territory in respect of which there is in force a certificate of airworthiness in any category and which is powered by one or more turbine engines;

- (b) carries on the business of manufacturing, repairing or overhauling such an aircraft, or any equipment or part thereof;
- (c) signs a certificate of maintenance review, or of release to service in respect of such an aircraft, part or equipment;
- (d) performs a function for which he requires an air traffic controller's licence;
- (e) is the licensee or manager of a licensed aerodrome;
- (f) performs a function connected with the installation, modification, maintenance, repair, overhaul, flight checking or inspection of equipment on the ground which is used or intended to be used for the purpose of or in connection with the provision of an air traffic control service or navigational aid to an aircraft;

shall:

- (i) make a report to the Governor of any reportable occurrence of which, he knows and which is of such a description as is specified in regulation 18 in Schedule 14: the report shall be made within such time, by such means, and shall contain such information as is so specified and it shall be presented in such form as the Governor may in any particular case approve; and
- (ii) make a report to the Governor, within such time, by such means; and containing such information as the Governor may specify in a notice in writing served upon him, being information which is in his possession or control and which relates to a reportable occurrence which has been reported by him or by another person to the Governor in accordance with this article.
 - (a) (2) (a) Subject to sub-paragraph (b), in this article "reportable occurrence" means:
 - (i) any incident relating to such an aircraft or any defect in or malfunctioning of such an aircraft or any part or equipment of such an aircraft, being an incident, malfunctioning or defect endangering, or which if not corrected would endanger, the aircraft, its occupants or any other person; and
 - (ii) any defect in or malfunctioning of any facility on the ground used or intended to be used for purposes of or in connection with the operation of such an aircraft, being a defect or malfunctioning endangering, or which if not corrected would endanger, such an aircraft or its occupants.
 - (b) Any accident or serious incident notified to the Governor in pursuance of regulations made under section 75 of the Civil Aviation Act 1982 as set out in Schedule 1 to the Civil Aviation Act 1982 (Overseas Territories) Order 2001⁽⁸⁾ shall not constitute a reportable occurrence for the purposes of this article.
- (3) Subject to paragraph (1)(f)(ii), nothing in this article shall require a person to report any occurrence which he has reason to believe has been or will be reported by another person to the Governor in accordance with this article.
- (4) A person shall not make any report under this article if he knows or has reason to believe that the report is false in any particular.
 - (a) (5) (a) Without prejudice to article 53(2), (4) and (5) and subject to article 80 of this Order and sub-paragraph (b), the operator of an aircraft shall, if he has reason to believe that a report has been or will be made in pursuance of this article, preserve any data from a flight data recorder or a combined cockpit voice recorder/flight data recorder relevant to the reportable occurrence for 14 days from the date on which a report of that occurrence is made to the Governor or for such longer period as the Governor may in a particular case direct.

⁽⁸⁾ S.I. 2001/1452.

- (b) The record referred to in sub-paragraph (a) may be erased if the aircraft is outside the Territory and it is not reasonably practicable to preserve the record until the aircraft reaches the Territory.

Power to prevent aircraft flying

118.—(1) If it appears to the Governor or an authorised person that any aircraft is intended or likely to be flown:

- (a) in such circumstances that any provision of article 3, 5, 6, 8, 20, 21, 35, 53, 59, 60, 113, 115 or 116 of this Order or any provision relating to the licensing of air transport in the Territory would be contravened in relation to the flight;
- (b) in such circumstances that the flight would be in contravention of any other provision of this Order, of any regulations made thereunder and be a cause of danger to any person or property whether or not in the aircraft; or
- (c) while in a condition unfit for the flight, whether or not the flight would otherwise be in contravention of any provision of this Order, of any regulation made thereunder;

the Governor or that authorised person may direct the operator or the commander of the aircraft that he is not to permit the aircraft to make the particular flight or any other flight of such description as may be specified in the direction, until the direction has been revoked by the Governor or by an authorised person, and the Governor or that authorised person may take such steps as are necessary to detain the aircraft.

(2) For the purpose of paragraph (1) the Governor and any authorised person may enter upon and inspect any aircraft.

Right of access to aerodromes and other places

119.—(1) Subject to paragraph (2), the Governor and any authorised person shall have the right of access at all reasonable times:

- (a) to any aerodrome, for the purpose of inspecting the aerodrome;
- (b) to any aerodrome for the purpose of inspecting any aircraft on the aerodrome or any document which he has the power to demand under this Order, or for the purpose of detaining any aircraft under the provisions of this Order; and
- (c) to any place where an aircraft has landed, for the purpose of inspecting the aircraft or any document which he has power to demand under this Order and for the purpose of detaining the aircraft under the provisions of this Order.

(2) Access to a Government aerodrome shall only be obtained with the permission of the person in charge of the aerodrome.

Obstruction of persons

120. A person shall not intentionally obstruct or impede any person acting in the exercise of his powers or the performance of his duties under this Order.

Enforcement of directions

121. Any person who without reasonable excuse fails to comply with any direction given to him under any provision of this Order or any regulations made thereunder shall be deemed for the purposes of this Order to have contravened that provision.

Penalties

122.—(1) If any provision of this Order or of any regulations made thereunder is contravened in relation to an aircraft, the operator of that aircraft and the commander thereof and, in the case of a contravention of article 113 of this Order, the charterer of that aircraft, shall (without prejudice to the liability of any other person for that contravention) be deemed for the purposes of the following provisions of this article to have contravened that provision unless he proves that the contravention occurred without his consent or connivance and that he exercised all due diligence to prevent the contravention.

(2) If it is proved that an act or omission of any person which would otherwise have been a contravention by that person of a provision of this Order or of any regulations made thereunder was due to any cause not avoidable by the exercise of reasonable care by that person the act or omission shall be deemed not to be a contravention by that person of that provision.

(3) Where a person is charged with contravening a provision of this Order or of any regulations made thereunder by reason of his having been a member of the flight crew of an aircraft on a flight for the purpose of public transport or aerial work the flight shall be treated (without prejudice to the liability of any other person under this Order) as not having been for that purpose if he proves that he neither knew nor suspected that the flight was for that purpose.

(4) If any person contravenes any provision of this Order or of any regulations made thereunder not being a provision referred to in paragraphs (5) or (6), he shall be guilty of an offence and liable on summary conviction to a fine not exceeding £1,000.

(5) If any person contravenes any provision specified in Part A of Schedule 12 to this Order he shall be guilty of an offence and liable on summary conviction to a fine not exceeding £2,500.

(6) If any person contravenes any provision specified in Part B of the said Schedule he shall be guilty of an offence and liable on summary conviction to a fine not exceeding £5,000 and on conviction on indictment to a fine or imprisonment for a term not exceeding two years or both.

Extra-territorial effect of the Order

123.—(1) Except where the context otherwise requires, the provisions of this Order:

- (a) insofar as they apply (whether by express reference or otherwise) to aircraft registered in the Territory, shall apply to such aircraft wherever they may be;
- (b) insofar as they apply as aforesaid to other aircraft shall apply to such other aircraft when they are within the Territory;
- (c) insofar as they prohibit, require or regulate (whether by express reference or otherwise) the doing of anything by persons in or by any of the crew of, any aircraft registered in the Territory, shall apply to such persons and crew, wherever they may be, and
- (d) insofar as they prohibit, require or regulate as aforesaid the doing of anything in relation to any aircraft registered in the Territory by other persons shall, where such persons are Commonwealth citizens, British protected persons or citizens of the Republic of Ireland, apply to them wherever they may be.

(2) Nothing in this article shall be construed as extending to make any person guilty of an offence in any case in which it is provided by section 3(1) of the British Nationality Act 1948⁽⁹⁾ (which limits the criminal liability of certain persons who are not citizens of the United Kingdom and colonies) that that person shall not be guilty of an offence.

(9) 1948 c. 56.

Application of Order to British-controlled aircraft not registered in the Territory

124. The Governor may direct that such of the provisions of this Order and of any regulations made or having effect thereunder as may be specified in the direction shall have effect as if reference in those provisions to aircraft registered in the Territory included references to the aircraft specified in the direction, being an aircraft not so registered but for the time being under the management of a person who, or of persons each of whom, is qualified to hold a legal or beneficial interest by way of ownership in an aircraft registered in the Territory.

Application of Order to the Crown and visiting forces, etc.

- (a) **125.** (1) (a) Subject to the following provisions of this article, the provisions of this Order shall apply to or in relation to aircraft belonging to or exclusively employed in the service of Her Majesty as they apply to or in relation to other aircraft.
- (b) For the purposes of such application, the Department or other authority for the time being responsible on behalf of Her Majesty for the management of the aircraft shall be deemed to be the operator of the aircraft and, in the case of an aircraft belonging to Her Majesty, to be the owner of the interest of Her Majesty in the aircraft.
- (c) Nothing in this article shall render liable to any penalty any Department or other authority responsible on behalf of Her Majesty for the management of any aircraft.

(2) Save as otherwise expressly provided the naval, military and air force authorities and members of any visiting force and any international headquarters and the members thereof and property held or used for the purpose of such a force or headquarters shall be exempt from the provisions of this Order and of any regulations made thereunder to the same extent as if that force or headquarters formed part of the forces of Her Majesty raised in the United Kingdom and for the time being serving in the Territory.

(3) Save as otherwise provided by paragraph (4), article 70(4) and (9), article 71(2)(a), and article 108 of this Order and the Rules of the Air, nothing in this Order shall apply to or in relation to any military aircraft.

(4) Where a military aircraft is flown by a civilian pilot and is not commanded by a person who is acting in the course of his duty as a member of any of Her Majesty's naval, military or air forces or as a member of a visiting force or international headquarters, the following provisions of this Order shall apply on the occasion of that flight, that is to say, articles 63, 64, 65 and 85 and in addition article 84 (so far as applicable) shall apply unless the aircraft is flown in compliance with Military Flying Regulations (Joint Service Publication 318) or Flying Orders to Contractors (Aviation Publication 67) issued by the Secretary of State.

Exemption from Order

126. The Governor may exempt from any of the provisions of this Order (other than articles 75, 77, 82, 113, 114, 115, 116 or 127 thereof) or any regulations made thereunder, any aircraft or persons or classes of aircraft or persons, either absolutely or subject to such conditions as he thinks fit.

Appeal to Supreme Court

127.—(1) An appeal shall lie to the Supreme Court or to such other court as may be prescribed from any decision of the Governor that a person is not a fit person to hold a licence to act as an aircraft maintenance engineer, member of the flight crew of an aircraft, air traffic controller, student air traffic controller or aerodrome flight information service officer, and if the court is satisfied that on the evidence submitted to the Governor he was wrong in so deciding, the court may reverse the Governor's decision and the Governor shall give effect to the court's determination.

(2) An appeal shall not lie from a decision of the Governor that a person is not qualified to hold the licence by reason of a deficiency in his knowledge, experience, competence, skill, physical or mental fitness.

(3) The respondent to any appeal under this article shall be the Attorney General or other principal legal officer of the Government of the Territory.

(4) For the purposes of any provision relating to the time within which an appeal may be brought, the Governor's decision shall be deemed to have been taken on the date on which the Governor furnished a statement of his reasons for the decision to the applicant for the licence, or as the case may be, the holder or former holder of it.

Application of Order

128. The provisions of this Order apply to the Territories mentioned in Schedule 18 to this Order, any one of which is in this Order referred to in the expression "the Territory".

Regulations by the Governor: Fees

129.—(1) The Governor may make regulations for prescribing anything which, under the provisions of this Order, is to be prescribed.

(2) The Governor, with the approval of a Secretary of State, may make regulations amending the Air Navigation (General) Regulations in Schedule 14 to this Order.

(3) Without prejudice to the generality of paragraph (1) of this article, such regulations may prescribe the fees to be charged in connection with the issue, validation, renewal, extension or variation of any certificate, licence or other document (including the issue of a copy thereof), or the undergoing of any examination, test, inspection or investigation or the grant of any permission or approval, required by, or for the purpose of, this Order or any regulations made thereunder.

(a) (4) (a) Upon an application being made in connection with which any fee is chargeable in accordance with the said provisions the applicant may be required before the application is entertained to pay the whole or to deposit a portion of the fee or fees so chargeable. If, after such payment or deposit has been made, the application is withdrawn by the applicant or otherwise ceases to have effect or is refused by the Governor, the Governor may, subject as hereinafter provided, refund the amount of such payment or deposit. Where the amount paid or deposited is wholly or to any extent attributable to a fee chargeable in respect of an investigation which would have been carried out in connection with the application if it had not been so withdrawn or ceased to have effect or been refused but which has not been carried out by reason only of such withdrawal, cesser or refusal, the Governor may refund the amount so attributable, or, subject to paragraph (b), in a case where an investigation has been partially completed, so much of that amount as in the opinion of the Governor is reasonable having regard to the stage to which the investigation has progressed at the time of such withdrawal, cesser or refusal.

(b) If in any case the amount deposited by the applicant is not sufficient to cover the fee, as ultimately assessed, chargeable in respect of any investigation in so far as the same has been carried out at the time when the application is withdrawn by him or otherwise ceases to have effect or is refused by the Governor the amount representing the balance of such fee shall be payable by the applicant.

In this paragraph the expression "investigation" includes an inspection, examination, calculation or test.

Interpretation

130.—(1) In this Order, unless the context otherwise requires:

“The Act” means the Civil Aviation Act 1949(10);

“Aerial work” has the meaning assigned to it by article 131 of this Order;

“Aerial work aircraft” means an aircraft (other than a public transport aircraft) flying, or intended by the operator to fly, for the purpose of aerial work;

“Aerial work undertaking” means an undertaking whose business includes the performance of aerial work;

“Aerobatic manoeuvres” includes loops, spins, rolls, bunts, stall turns, inverted flying and any other similar manoeuvre;

“Aerodrome” means any area of land or water designed, equipped, set apart or commonly used for affording facilities for the landing and departure of aircraft and includes any area or space, whether on the ground, on the roof of a building or elsewhere, which is designed, equipped or set apart for affording facilities for the landing and departure of aircraft capable of descending or climbing vertically, but shall not include any area the use of which for affording facilities for the landing and departure of aircraft has been abandoned and has not been resumed;

“Aerodrome control service” means an air traffic control service for any aircraft on the manoeuvring area or apron of the aerodrome in respect of which the service is being provided or which is flying in, or in the vicinity of, the aerodrome traffic zone of that aerodrome by visual reference to the surface;

“Aerodrome operating minima” in relation to the operation of an aircraft at an aerodrome means the cloud ceiling and runway visual range for take-off, and the decision height or minimum descent height, runway visual range and visual reference for landing, which are the minimum for the operation of that aircraft at that aerodrome;

“Aerodrome traffic zone” means the airspace specified below, being airspace in the vicinity of an aerodrome which is notified for the purposes of rule 39 of the Rules of the Air:

- (a) in relation to such an aerodrome at which the length of the longest runway is notified as 1,850 metres or less:
 - (i) subject to sub-paragraph (ii), the airspace extending from the surface to a height of 2,000 ft above the level of the aerodrome within the area bounded by a circle centred on the notified mid-point of the longest runway and having a radius of two nautical miles;
 - (ii) where such an aerodrome traffic zone would extend less than one and a half nautical miles beyond the end of any runway at the aerodrome and this sub-paragraph is notified as being applicable, sub-paragraph (b) shall apply as though the length of the longest runway is notified as greater than 1,850 metres;
- (b) in relation to such an aerodrome at which the length of the longest runway is notified as greater than 1,850 metres, the airspace extending from the surface to a height of 2,000 ft above the level of the aerodrome within the area bounded by a circle centred on the notified mid-point of the longest runway and having a radius of two and a half nautical miles;

except any part of that airspace which is within the aerodrome traffic zone of another aerodrome which is notified for the purposes of this Order as being the controlling aerodrome;

“Aeronautical beacon” means an aeronautical ground light which is visible either continuously or intermittently to designate a particular point on the surface of the earth;

“Aeronautical ground light” means any light specifically provided as an aid to air navigation, other than a light displayed on an aircraft;

“Aeronautical radio station” means a radio station on the surface, which transmits or receives signals for the purpose of assisting aircraft;

“Air traffic control unit” means a person appointed by the Governor or by any other person maintaining an aerodrome or place to give instructions, advice or information by means of radio signals to aircraft in the interests of safety but does not include a person so appointed solely to provide a flight information service to aircraft, and “air traffic control service” shall be construed accordingly;

“Air transport undertaking” means an undertaking whose business includes the undertaking of flights for the purposes of public transport of passengers or cargo;

“Annual costs” in relation to the operation of an aircraft means the best estimate reasonably practicable at the time of a particular flight in respect of the year commencing on the first day of January preceding the date of the flight, of the costs of keeping and maintaining and the indirect costs of operating the aircraft, such costs in either case excluding direct costs and being those actually and necessarily incurred without a view to profit;

“Annual flying hours” means the best estimate reasonably practicable at the time of a particular flight by an aircraft of the hours flown or to be flown by the aircraft in respect of the year commencing on the first day of January preceding the date of the flight;

“Approach control service” means an air traffic control service for any aircraft which is not receiving an aerodrome control service, which is flying in, or in the vicinity of the aerodrome traffic zone of the aerodrome in respect of which the service is being provided, whether or not the aircraft is flying by visual reference to the surface;

“Approach to landing” means that portion of the flight of the aircraft, when approaching to land, in which it is descending below a height of 1,000 ft above the relevant specified decision height or minimum descent height;

“Appropriate aeronautical radio station” means in relation to an aircraft an aeronautical radio station serving the area in which the aircraft is for the time being;

“Appropriate air traffic control unit” means in relation to an aircraft either the air traffic control unit serving the area in which the aircraft is for the time being or the air traffic control unit serving the area which the aircraft intends to enter and with which unit the aircraft is required to communicate prior to entering that area, as the case may be;

“Apron” means the part of an aerodrome provided for the stationing of aircraft for the embarkation and disembarkation of passengers, for loading and unloading of cargo and for parking;

“Area control centre” means an air traffic control unit established to provide an area control service to aircraft flying within a notified flight information region which are not receiving an aerodrome control service or an approach control service;

“Area control service” means an air traffic control service for any aircraft which is flying neither in nor in the vicinity of an aerodrome traffic zone except for an aerodrome traffic zone which has been notified as being subject to an area control service;

“Area navigation equipment” means equipment carried on board an aircraft which enables the aircraft to navigate on any desired flight path within the coverage of appropriate ground based navigation aids or within the limits of that on-board equipment or a combination of the two;

“Authorised person” means any person authorised by the Governor either generally or in relation to a particular case or class of cases, and references to a person authorised by the Governor include references to the Director of Civil Aviation in the Territory and the holder for the time being of any office designated by the Governor;

“Beneficial interest” includes interests arising under contract and other equitable interests;

“Cabin attendant” in relation to an aircraft means a person on a flight for the purpose of public transport carried for the purpose of performing in the interests of the safety of passengers duties to be assigned by the operator or the commander of the aircraft but who shall not act as a member of the flight crew;

“Captive balloon” means a balloon which when in flight is attached by a restraining device to the surface;

“Captive flight” means flight by an uncontrollable balloon during which it is attached to the surface by a restraining device;

“Cargo” includes mail and animals;

“Certificate of airworthiness” includes any validation thereof and any flight manual, performance schedule or other document, whatever its title, incorporated by reference in that certificate relating to the certificate of airworthiness;

“Certificate of maintenance review” has the meaning assigned to it by article 10(1) of this Order;

“Certificate of release to service” has the meaning assigned to it by article 12(7) of this Order;

“Certificated for single pilot operation” means an aircraft which is not required to carry more than one pilot by virtue of any one or more of the following:

- (a) the certificate of airworthiness duly issued or rendered valid under the law of the country in which the aircraft is registered;
- (b) if no certificate of airworthiness is required to be in force, the certificate of airworthiness, if any, last in force in respect of the aircraft;
- (c) if no certificate of airworthiness is or has previously been in force but the aircraft is identical in design with an aircraft in respect of which such a certificate is or has been in force, the certificate of airworthiness which is or has been in force in respect of such an identical aircraft; or
- (d) in the case of an aircraft flying in accordance with the conditions of a permit to fly issued by the Governor, that permit to fly;

“The Civil Aviation Authority” means the body corporate constituted in accordance with the provisions of section 2 of the Civil Aviation Act 1982⁽¹¹⁾;

“Class A airspace”, “Class B airspace”, “Class C airspace”, “Class D airspace” and “Class E airspace” mean airspace respectively notified as such;

“Cloud ceiling” in relation to an aerodrome means the vertical distance from the elevation of the aerodrome to the lowest part of any cloud visible from the aerodrome which is sufficient to obscure more than one-half of the sky so visible;

“Commander” in relation to an aircraft means the member of the flight crew designated as commander of that aircraft by the operator thereof, or, failing such a person, the person who is for the time being the pilot in command of the aircraft;

“the Commonwealth” means the United Kingdom, the Channel Islands, the Isle of Man, the countries mentioned in Schedule 3 to the British Nationality Act 1981⁽¹²⁾ and all other territories forming part of Her Majesty’s dominions or in which Her Majesty has jurisdiction;

“Competent authority” means in relation to the Territory, the Governor, and in relation to any other country the authority responsible under the law of that country for promoting the safety of civil aviation;

(11) 1982 c. 16.

(12) 1981 c. 61, as amended by S.I. 1983/892; S.I. 1983/1699; the Brunei and Maldives Act 1985 section 1 and Schedule paragraph 8; S.I. 1989/1331; S.I. 1990/1502 and S.I. 1998/3161.

“Conditional sale agreement” has the same meaning as in section 189 of the Consumer Credit Act 1974(13);

“Congested area” in relation to a city, town or settlement, means any area which is substantially used for residential, industrial, commercial or recreational purposes;

“Contracting State” means any State (including the United Kingdom and any of the Territories) which is party to the Convention on Civil Aviation signed on behalf of the Government of the United Kingdom at Chicago on 7 December 1944;

“Controllable balloon” means a balloon, not being a small balloon, which is capable of free controlled flight;

“Controlled airspace” means airspace which has been notified as Class A, Class B, Class C, Class D or Class E airspace;

“Control area” means controlled airspace which has been further notified as a control area and which extends upwards from a notified altitude or flight level;

“Control zone” means controlled airspace which has been further notified as a control zone and which extends upwards from the surface;

“Co-pilot” in relation to an aircraft means a pilot who in performing his duties as such is subject to the direction of another pilot carried in the aircraft;

“Country” includes a territory, except in paragraph (3)(b);

“Crew” means a member of the flight crew, a person carried on the flight deck who is appointed by the operator of the aircraft to give or to supervise the training, experience, practice and periodical tests required in respect of the flight crew under article 34(3) of this Order or a cabin attendant;

“Danger area” means airspace which has been notified as such within which activities dangerous to the flight of aircraft may take place or exist at such times as may be notified;

“Day” means the time from half an hour before sunrise until half an hour after sunset (both times exclusive), sunset and sunrise being determined at surface level;

“Decision height” in relation to the operation of an aircraft at an aerodrome means the height in a precision approach at which a missed approach must be initiated if the required visual reference to continue that approach has not been established;

“Declared distances” has the meaning which has been notified;

“Direct costs” means, in respect of a flight, the costs actually and necessarily incurred in connection with that flight without a view to profit but excluding any remuneration payable to the pilot for his services as such;

“Director” has the same meaning as in section 53(1) of the Companies Act 1989(14);

“Flight” and “to fly” have the meanings respectively assigned to them by paragraph (4);

“Flight crew” in relation to an aircraft means those members of the crew of the aircraft who respectively undertake to act as pilot, flight navigator, flight engineer and flight radiotelephony operator of the aircraft;

“Flight information service unit” means a person appointed by the Governor or by any other person maintaining an aerodrome or area control centre:

- (a) in the case of such a unit appointed in respect of an aerodrome to:
 - (i) give information by means of radio signals to aircraft flying in or intending to fly within the aerodrome traffic zone of that aerodrome; and

(13) 1974 c. 39.

(14) 1989 c. 40.

- (ii) grant or refuse permission, pursuant to Rule 35 or 36(2) of the Rules of the Air;
- (b) in the case of such a unit appointed in respect of an area control centre, to give information by means of radio signals to aircraft;

and “flight information service”, “aerodrome flight information service” and “aerodrome flight information service unit” shall be construed accordingly;

“Flight level” means one of a series of levels of equal atmospheric pressure, separated by notified intervals and each expressed as the number of hundreds of feet which would be indicated at that level on a pressure altimeter calibrated in accordance with the International Standard Atmosphere and set to 1013.2 hectopascals;

“Flight plan” means such information as may be notified in respect of an air traffic control service unit being information provided or to be provided to that unit, relative to an intended flight or portion of a flight of an aircraft;

“Flight recording system” means a system comprising either a flight data recorder or a cockpit voice recorder or both;

“Flight simulator” means apparatus by means of which flight conditions in an aircraft are simulated on the ground;

“Flight visibility” means the visibility forward from the flight deck of an aircraft in flight;

“Flying display” means any flying activity deliberately performed for the purpose of providing an exhibition or entertainment at an advertised event open to the public;

“Free balloon” means a balloon which when in flight is not attached by any form of restraining device to the surface;

“Free controlled flight” means flight during which a balloon is not attached to the surface by any form of restraining device (other than a tether not exceeding five metres in length which may be used as part of the take-off procedure) and during which the height of the balloon is controllable by means of a device attached to the balloon and operated by the commander of the balloon or by remote control;

“General lighthouse authority” has the same meaning as in section 193 of the Merchant Shipping Act 1995(15);

“Government aerodrome” means any aerodrome in the Territory which is under the control of the Governor or is in the occupation of any Department of the Government of the Territory or of the Government of the United Kingdom, or of Her Majesty’s naval, military or air forces, or of any visiting force;

“Governor” means the officer for the time being administering the Government of the Territory, and includes, in relation to any purpose of this Order, other than the purposes of making rules or regulations under this Order or of making or revoking a designation under article 111 of this Order:

- (a) any person appointed by the Governor as Director of Civil Aviation in the Territory, being the person responsible under the law of the Territory on behalf of the Governor for the administration of this Order;
- (b) any person who, or the holder for the time being of any office which, is designated for the time being for that purpose by the Governor with the approval of the Secretary of State;

“Hire-purchase agreement” has the same meaning as in section 189 of the Consumer Credit Act 1974(16);

“Instrument Flight Rules” means Instrument Flight Rules specified in the Rules of the Air;

(15) 1995 c. 21.

(16) 1974 c. 39.

“Instrument Meteorological Conditions” means weather precluding flight in compliance with the Visual Flight Rules;

“International headquarters” means an international headquarters designated by Order in Council under section 1 of the International Headquarters and Defence Organisations Act 1964(17), as extended to the Territory;

“To land” in relation to aircraft includes alighting on the water;

“Legal personal representative” means the person so constituted executor, administrator, or other representative, of a deceased person;

“Licence” includes any certificate of competency or certificate of validity issued with the licence or required to be held in connection with the licence by the law of the country in which the licence is granted;

“Licence for public use” has the meaning assigned to it by article 103(3) of this Order;

“Licensed aerodrome” means an aerodrome licensed under this Order;

“Lifejacket” includes any device designed to support a person individually in or on the water;

“Log book” in the case of an aircraft log book, engine log book or variable pitch propeller log book, or personal flying log book, includes a record kept either in a book, or by any other means approved by the Governor in the particular case;

“Manoeuvring area” means the part of an aerodrome provided for the take-off and landing of aircraft and for the movement of aircraft on the surface, excluding the apron and any part of the aerodrome provided for the maintenance of aircraft;

“Maximum total weight authorised” in relation to an aircraft means the maximum total weight of the aircraft and its contents at which the aircraft may take off anywhere in the world, in the most favourable circumstances in accordance with the certificate of airworthiness in force in respect of the aircraft;

“Medical attendant” means a person carried on a flight for the purpose of attending to any person in the aircraft in need of medical attention, or to be available to attend to such a person;

“Microlight aeroplane” means an aeroplane having a maximum total weight authorised not exceeding 390 kg, a wing loading at the maximum total weight authorised not exceeding 25 kg per square metre, a maximum fuel capacity not exceeding 50 litres and which has been designed to carry not more than two persons;

“Military aircraft” means the naval, military or air force aircraft of any country and:

- (a) any aircraft being constructed for the naval, military or air force of any country under a contract entered into by the Secretary of State; and
- (b) any aircraft in respect of which there is in force a certificate issued by the Secretary of State that the aircraft is to be treated for the purposes of this Order as a military aircraft;

“Minimum descent height” in relation to the operation of an aircraft at an aerodrome means the height in a non-precision approach below which descent may not be made without the required visual reference;

“Nautical mile” means the International Nautical Mile, that is to say, a distance of 1,852 metres;

“Night” means the time from half an hour after sunset until half an hour before sunrise (both times inclusive), sunset and sunrise being determined at surface level;

“Non-precision approach” means an instrument approach using non-visual aids for guidance in azimuth or elevation but which is not a precision approach;

“North Atlantic Minimum Navigation Performance Specification airspace” means the airspace specified as such in regulation 19(3) in Schedule 14 to this Order;

“Notified” means shown in any of the following publications for the time being in force and issued in the Territory whether before or after the coming into operation of this Order, that is to say, “Notams (Notices to Airmen)”, “Aeronautical Information Publications (AIP)”, or such other official publications so issued for the purpose of enabling any of the provisions of this Order to be complied with;

“Obstacle limitation surfaces” has the same meaning as in “CAP 168 Licensing of aerodromes”(18);

“Operator” has the meaning assigned to it by paragraph (5);

“Parascending parachute” means a parachute which is towed by cable in such a manner as to cause it to ascend;

“Passenger” means a person other than a member of the crew;

“Period of duty” means the period between the commencement and end of a shift during which an air traffic controller performs, or could be called upon to perform, any of the functions specified in respect of a rating included in his licence;

“Pilot in command” in relation to an aircraft means a person who for the time being is in charge of the piloting of the aircraft without being under the direction of any other pilot in the aircraft;

“Precision approach” means an instrument approach using Instrument Landing System, Microwave Landing System or Precision Approach Radar for guidance in both azimuth and elevation;

“Prescribed” means prescribed by regulations made by the Governor under this Order, and the expression “prescribe” shall be construed accordingly;

“Pressurised aircraft” means an aircraft provided with means of maintaining in any compartment a pressure greater than that of the surrounding atmosphere;

“Private flight” means a flight which is neither for the purpose of aerial work nor public transport;

“Public transport” has the meaning assigned to it by article 131 of this Order;

“Public transport aircraft” means an aircraft flying, or intended by the operator of the aircraft to fly, for the purpose of public transport;

“Record” includes, in addition to a record in writing-

- (a) any disc, tape, sound-track or other device in which sounds or signals are embodied so as to be capable (with or without the aid of some other instrument) of being reproduced therefrom;
- (b) any film, tape or other device in which visual images are embodied so as to be capable (as aforesaid) of being reproduced therefrom; and
- (c) any photograph;

and any reference to a copy of a record includes, in the case of a record falling within paragraph (a) only of this definition, a transcript of the sounds or signals embodied therein, in the case of a record falling within paragraph (b) only of this definition, a still reproduction of the images embodied therein, and in the case of a record falling within both those paragraphs, such a transcript together with such a still reproduction;

“Reduced vertical separation minimum airspace”, means any airspace between flight level 290 and flight level 410 inclusive designated by the relevant competent authority as being airspace within which a vertical separation minimum of 1,000 ft or 300 metres shall be applied;

“Released flight” means flight by an uncontrollable balloon during which it is not attached to the surface by any form of restraining device;

“Replacement” in relation to any part of an aircraft or its equipment includes the removal and replacement of that part whether or not by the same part, and whether or not any work is done on it; but does not include the removal and replacement of a part which is designated to be removable solely for the purpose of enabling another part to be inspected, repaired, removed or replaced or cargo to be loaded;

“Rules of the Air” means the rules in Schedule 13 to this Order and any supplementary rules made by the Governor under article 84(1);

“Runway visual range” in relation to a runway means the distance in the direction of take-off or landing over which the runway lights or surface markings may be seen from the touchdown zone as calculated by either human observation or instruments in the vicinity of the touchdown zone or where this is not reasonably practicable in the vicinity of the mid-point of the runway; and the distance, if any, communicated to the commander of an aircraft by or on behalf of the person in charge of the aerodrome as being the runway visual range shall be taken to be the runway visual range for the time being;

“Scheduled journey” means one of a series of journeys which are undertaken between the same two places and which together amount to a systematic service;

“Seaplane” includes a flying boat and any other aircraft designed to manoeuvre on water;

“Sector” means part of the airspace controlled from an area control centre or other place;

“Small aircraft” means any unmanned aircraft, other than a balloon or a kite, weighing not more than 20 kg without its fuel but including any articles or equipment installed in or attached to the aircraft at the commencement of its flight;

“Small balloon” means a balloon not exceeding two metres in any linear dimension at any stage of its flight, including any basket or other equipment attached to the balloon;

“Special VFR flight” means a flight which is a special VFR flight for the purposes of the Rules of the Air;

“State of the operator” means the State in which the operator of an aircraft has his principal place of business or, if he has no such place of business, his permanent residence, in circumstances where:

- (a) that aircraft is registered in another Contracting State;
- (b) the operator is operating that aircraft pursuant to an agreement for its lease, charter or interchange or any similar arrangement;
- (c) the State in which the aircraft is registered has, by agreement with the State in which the operator of the aircraft has his principal place of business or, if he has no such place of business, his permanent residence, agreed to transfer to it its functions and duties as State of registry in respect of that aircraft in relation to, in the case of article 8(1), airworthiness, in the case of article 15(1), aircraft radio equipment, in the case of article 21(3), flight crew licensing or in the case of article 46(1), radio licensing; and
- (d) the agreement has been registered with the Council of the International Civil Aviation Organisation or the existence and scope of the agreement have been directly communicated to the Governor.

“Supreme Court” means the highest court exercising original jurisdiction in respect of the Territory;

“The Territory” has the meaning assigned to it by article 128 of this Order and includes the dependencies of the Territory and the adjacent territorial waters;

“Territory reduced vertical separation minimum airspace” means Territory airspace which has been notified as reduced vertical separation minimum airspace for the purposes of article 48;

“Tethered flight” means flight by a controllable balloon throughout which it is flown within limits imposed by a restraining device which attaches the balloon to the surface;

“Uncontrollable balloon” means a balloon, not being a small balloon, which is not capable of free controlled flight;

“Valuable consideration” means any right, interest, profit or benefit, forbearance, detriment, loss or responsibility accruing, given, suffered or undertaken pursuant to an agreement, which is of more than a nominal nature;

“Visual Flight Rules” means Visual Flight Rules prescribed by the Rules of the Air;

“Visual Meteorological Conditions” means weather permitting flight in accordance with the Visual Flight Rules.

(2) In this Order references to sums expressed in terms of sterling shall be construed as references to the equivalent sums in the currency of the Territory calculated at such rate of exchange as may be prescribed or as the Governor may by order direct.

(a) (3) (a) In its application to any Territory which is mentioned in Schedule 18 to this Order but is not mentioned in the First Schedule to the Visiting Forces Act (Application to Colonies) Order 1954(19), as amended from time to time, this Order shall have effect as if—

(i) the words “or of any visiting force” were omitted from article 70(8)(a);

(ii) the words “or a visiting force” were omitted from article 94(5);

(iii) the whole of paragraph (2) were omitted from article 125;

(iv) the words “or as a member of a visiting force” were omitted from article 125(4); and

(v) in paragraph (1) the words “or of any visiting force” were omitted from the definition of “Government aerodrome”.

(b) In relation to any Territory which is mentioned in Schedule 18 to this Order and is also mentioned in the First Schedule to the Visiting Forces Act (Application to Colonies) Order 1954, as amended from time to time, the expression “visiting force” in this Order means any such body, contingent or detachment of the forces of any country as is a visiting force for the purposes of any of the provisions of the Visiting Forces Act 1952(20), which extend to that Territory, in respect of that country, by virtue of any Order in Council made under section 1(2) or under section 15 of that Act.

(4) An aircraft shall be deemed to be in flight:

(a) in the case of a piloted flying machine, from the moment when, after the embarkation of its crew for the purpose of taking off, it first moves under its own power until the moment when it next comes to rest after landing;

(b) in the case of a pilotless flying machine, or a glider, from the moment when it first moves for the purpose of taking off until the moment when it next comes to rest after landing;

(c) in the case of an airship, from the moment when it first becomes detached from the surface until the moment when it next becomes attached thereto or comes to rest thereon;

(d) in the case of a free balloon, from the moment when the balloon, including the canopy and basket, becomes separated from the surface until the moment it next comes to rest thereon; and

(19) S.I. 1954/636.

(20) 1952 c. 67.

(e) in the case of a captive balloon, from the moment when the balloon, including the canopy and basket, becomes separated from the surface, apart from a restraining device attaching it to the surface, until the moment when it next comes to rest thereon;
and the expressions a “flight” and “to fly” shall be construed accordingly.

(a) (5) (a) Subject to sub-paragraph (b), references in this Order to the operator of an aircraft are, for the purposes of the application of any provision of this Order in relation to any particular aircraft, references to the person who at the relevant time has the management of that aircraft, and cognate expressions shall be construed accordingly.

(b) For the purposes of the application of any provision in Part III of this Order, when by virtue of any charter or other agreement for the hire or loan of an aircraft a person other than an air transport undertaking or an aerial work undertaking has the management of that aircraft for a period not exceeding 14 days, the foregoing provisions of this paragraph shall have effect as if that agreement had not been entered into.

(6) The expressions appearing in the “General classification of aircraft” set forth in Part A of Schedule 2 to this Order shall have the meanings thereby assigned to them.

(7) A power to make regulations under this Order shall include the power to make different provisions with respect to different classes of aircraft, aerodromes, persons or property and with respect to different circumstances and with respect to different parts of the Territory and to make such incidental and supplementary provisions as are necessary or expedient for carrying out the purposes of the Order.

(8) The Interpretation Act 1978⁽²¹⁾ applies for the purpose of the interpretation of this Order and otherwise in relation thereto as it applies for the purpose of the interpretation of, and in relation to, an Act of Parliament of the United Kingdom, and as if this Order were such an Act of Parliament.

(a) (9) (a) Any power conferred by this Order to issue, make, serve or grant any instrument shall be construed as including a power exercisable, in the like manner and subject to the like conditions, if any, to vary, revoke, cancel or otherwise terminate the instrument.

(b) In this paragraph “instrument” includes any regulations, direction, instruction, rule or other requirement, any notice and any certificate, licence, approval, permission, exemption, authorisation, log book record or other document.

Public transport and aerial work

(a) **131.** (1) (a) Subject to the provisions of this article, aerial work means any purpose (other than public transport) for which an aircraft is flown if valuable consideration is given or promised in respect of the flight or the purpose of the flight.

(b) If the only such valuable consideration consists of remuneration for the services of the pilot the flight shall be deemed to be a private flight for the purposes of Part III of this Order.

(2) Subject to the provisions of this article, an aircraft in flight shall for the purposes of this Order be deemed to fly for the purposes of public transport:

(a) if valuable consideration is given or promised for the carriage of passengers or cargo in the aircraft on that flight;

(b) if any passengers or cargo are carried gratuitously in the aircraft on that flight by an air transport undertaking, not being persons in the employment of the undertaking (including, in the case of a body corporate, its directors) and persons with the authority of the Governor either making any inspection or witnessing any training, practice or test for the purposes of this Order, or cargo intended to be used by any such passengers as aforesaid, or by the undertaking; or

(21) 1978 c. 30.

- (c) for the purposes of Part III of this Order (other than articles 14(2) and 15(2) thereof), if valuable consideration is given or promised for the primary purpose of conferring on a particular person the right to fly the aircraft on that flight (not being a single-seat aircraft of which the maximum total weight authorised does not exceed 910 kg) otherwise than under a hire-purchase or conditional sale agreement.
- (a) (3) (a) Notwithstanding that an aircraft may be flying for the purpose of public transport by reason of paragraph (2)(c), it shall not be deemed to be flying for the purpose of the public transport of passengers unless valuable consideration is given for the carriage of those passengers.
- (b) A glider shall not be deemed to fly for the purpose of public transport for the purposes of Part III of this Order by virtue of paragraph (2)(c) if the valuable consideration given or promised for the primary purpose of conferring on a particular person the right to fly the glider on that flight is given or promised by a member of a flying club and the glider is owned or operated by that flying club.
- (c) Notwithstanding the giving or promising of valuable consideration specified in sub-paragraph (2)(c) in respect of the flight or the purpose of the flight it shall:
- (i) subject to sub-paragraph (ii), for all purposes other than Part III of this Order; and
 - (ii) for the purposes of articles 14(2) and 15(2) of this Order;
- be deemed to be a private flight.
- (4) Where under a transaction effected by or on behalf of a member of an association of persons on the one hand and the association of persons or any member thereof on the other hand, a person is carried in, or is given the right to fly, an aircraft in such circumstances that valuable consideration would be given or promised if the transaction were effected otherwise than aforesaid, valuable consideration shall, for the purposes of this Order, be deemed to have been given or promised, notwithstanding any rule of law as to such transactions.
- (a) (5) (a) For the purposes of paragraph (2)(a), there shall be disregarded any valuable consideration given or promised in respect of a flight or the purpose of a flight by one company to another company which is:
- (i) its holding company;
 - (ii) its subsidiary; or
 - (iii) another subsidiary of the same holding company.
- (b) For the purposes of this article “holding company” and “subsidiary” have the meanings respectively specified in Section 736 of the Companies Act 1985(22).
- (a) (6) (a) A flight shall, for the purposes of Part IV of this Order, be deemed to be a private flight if:
- (i) the flight is:
 - (aa) wholly or principally for the purpose of taking part in an aircraft race, contest or flying display;
 - (bb) for the purpose of positioning the aircraft for such a flight as is specified in sub-paragraph (aa) hereof and is made with the intention of carrying out such a flight; or
 - (cc) for the purpose of returning after such a flight as is specified in sub-paragraph (aa) hereof to a place at which the aircraft is usually based;
 - (ii) the only valuable consideration in respect of the flight or the purpose of the flight other than:

- (aa) valuable consideration specified at paragraph (2)(c); or
- (bb) in the case of an aircraft owned in accordance with paragraph (10)(a), valuable consideration which falls within paragraph (10)(b);

is either:

- (cc) that given or promised to the owner or operator of an aircraft taking part in such a race, contest or flying display and such valuable consideration does not exceed the direct costs of the flight and a contribution to the annual costs of the aircraft which contribution shall bear no greater proportion to the total annual costs of the aircraft than the duration of the flight bears to the annual flying hours of the aircraft; or
- (dd) one or more prizes awarded to the pilot in command of an aircraft taking part in an aircraft race or contest to a value which shall not exceed £500 in respect of any one race or contest except with the permission in writing of the Governor granted to the organiser of the race or contest which permission may be granted subject to such conditions as the Governor thinks fit;

or falls within both sub-paragraphs (cc) and (dd).

- (b) Any prize falling within paragraph (6)(a)(ii)(dd) shall be deemed for the purposes of this Order not to constitute remuneration for services as a pilot.

- (a) (7) (a) Subject to paragraph (b), a flight shall be deemed to be a private flight if the only valuable consideration given or promised in respect of the flight or the purpose of the flight other than:

- (i) valuable consideration specified at paragraph (2)(c); or
- (ii) in the case of an aircraft owned in accordance with paragraph (10)(a), valuable consideration which falls within paragraph (10)(b);

is given or promised to a registered charity which is not the operator of the aircraft and the flight is made with the permission in writing of the Governor and in accordance with any conditions therein specified.

- (b) If valuable consideration specified at paragraph (2)(c) is given or promised the provisions of that paragraph shall apply to the flight.

- (a) (8) (a) Subject to paragraph (b), a flight shall be deemed to be a private flight if:

- (i) the only valuable consideration given or promised in respect of the flight or the purpose of the flight other than:

- (aa) valuable consideration specified at paragraph (2)(c); or
- (bb) in the case of an aircraft owned in accordance with paragraph (10)(a), valuable consideration which falls within paragraph (10)(b);

is a contribution to the direct costs of the flight otherwise payable by the pilot in command; and

- (ii) (aa) no more than four persons (including the pilot) are carried on such a flight;
- (bb) the proportion which such contribution bears to the total direct costs of the flight shall not exceed the proportion which the number of persons carried on the flight (excluding the pilot) bears to the number of persons carried on the flight (including the pilot);
- (cc) no information concerning the flight shall have been published or advertised prior to the commencement of the flight other than, in the case of an aircraft operated by a flying club, advertising wholly within the premises of such

a flying club in which case all the persons carried on such a flight who are aged 18 years or over shall be members of that flying club; and

(dd) no person acting as a pilot on such a flight shall be employed as a pilot by or be a party to a contract for the provision of services as a pilot with the operator of the aircraft being flown on the flight.

(b) If valuable consideration specified at paragraph (2)(c) is given or promised the provisions of that paragraph shall apply to the flight.

(a) (9) (a) Subject to paragraph (b), a flight shall be deemed to be a private flight if the only valuable consideration given or promised in respect of the flight or the purpose of the flight other than:

(i) valuable consideration specified at paragraph (2)(c); or

(ii) in the case of an aircraft owned in accordance with paragraph (10)(a), valuable consideration which falls within paragraph (10)(b);

is the payment of the whole or part of the direct costs otherwise payable by the pilot in command by or on behalf of the employer of the pilot in command, or by or on behalf of a body corporate of which the pilot in command is a director, provided that neither the pilot in command nor any other person who is carried is legally obliged, whether under a contract or otherwise, to be carried.

(b) If valuable consideration specified at paragraph (2)(c) is given or promised the provisions of that paragraph shall apply to the flight.

(10) A flight shall be deemed to be a private flight if:

(a) the aircraft is owned:

(i) jointly by persons (each of whom is a natural person) who each hold not less than a 5 per cent beneficial share and:

(aa) the aircraft is registered in the names of all the joint owners; or

(bb) the aircraft is registered in the name or names of one or more of the joint owners as trustee or trustees for all the joint owners, and written notice has been given to the Governor of the names of all the persons beneficially entitled to share in the aircraft; or

(ii) by a company in the name of which the aircraft is registered and the registered shareholders of which (each of whom is a natural person) each hold not less than 5 per cent of the shares in that company; and

(b) the only valuable consideration given or promised in respect of the flight or the purpose of the flight is either:

(i) in respect of and is no greater than the direct costs of the flight and is given, or promised by one or more of the joint owners of the aircraft or registered shareholders of the company which owns the aircraft; or

(ii) in respect of the annual costs and given by one or more of such joint owners or shareholders (as aforesaid):

or falls within both sub-paragraphs (i) and (ii).

(11) A flight in respect of which valuable consideration has been given or promised for the carriage of passengers and which is for the purpose of:

(a) the dropping of persons by parachute and which is made under and in accordance with the terms of a written permission granted by the Governor pursuant to article 57 of this Order;

(b) positioning the aircraft for such a flight as is specified in sub-paragraph (a) and which is made with the intention of carrying out such a flight and on which no person is carried who it is not intended shall be carried on such a flight and who may be carried on such a flight

in accordance with the terms of a written permission granted by the Governor pursuant to article 57 of this Order; or

- (c) returning after such a flight as is specified in sub-paragraph (a) hereof to the place at which the persons carried on such a flight are usually based and on which flight no persons are carried other than persons carried on the flight specified in sub-paragraph (a);

shall be deemed to be for the purposes of aerial work.

Saving

132.—(1) Subject to the provision of articles 103 and 107 of this Order, nothing in this Order or any regulations made thereunder shall confer any right to land in any place as against the owner of the land or other persons interested therein.

(2) Nothing in this Order shall oblige the Governor to accept an application from the holder of any current certificate, licence, approval, permission, exemption or other document, being an application for the renewal of that document, or for the granting of another document in continuation of or in substitution for the current document, if the application is made more than 60 days before the current document is due to expire.

Exceptions for certain classes of aircraft

133. The provisions of this Order other than articles 58, 64, 85(1), 86, 87, 118(1)(b), 130(1), (4) and (7) shall not apply to or in relation to:

- (a) any small balloon;
- (b) any kite weighing not more than 2 kg;
- (c) any small aircraft; or
- (d) any parachute, including a parascending parachute.

Approval for persons to furnish reports

134. In relation to any of his functions pursuant to any of the provisions of this Order the Governor may, either absolutely or subject to such conditions as he thinks fit, approve a person as qualified to furnish reports to him and may accept such reports.

Publication of requirements

135.—(1) Subject to paragraph (2), where any provision of this Order provides for the Governor to grant a certificate, licence or other document if he is satisfied as to matters specified in the provision, he shall publish the requirements which must be met by an applicant for such a certificate, licence or other document in order to so satisfy him.

(2) Nothing in this article shall require the Governor to publish requirements in respect of a licence, certificate or other document if he does not exercise his powers to grant the licence, certificate or document in question.

A. K. Galloway
Clerk of the Privy Council

Status: This is the original version (as it was originally made). This item of legislation is currently only available in its original format.

SCHEDULE 1

Article 2

ORDERS REVOKED

	References
The Air Navigation (Overseas Territories) Order 1989	S.I.1989/2395
The Air Navigation (Overseas Territories) (Amendment) Order 1991	S.I. 1991/189
The Air Navigation (Overseas Territories) (Amendment) (No 2) Order 1991	S.I. 1991/1697
The Air Navigation (Overseas Territories) (Amendment) Order 1992	S.I. 1992/3198
The Air Navigation (Overseas Territories) (Amendment) Order 1995	S.I. 1995/2701
The Air Navigation (Overseas Territories) (Amendment) Order 1997	S.I. 1997/1746

SCHEDULE 2

Articles 4(6), 29(3) and 130(6)

PART A

Table of general classification of aircraft

<i>Col. 1</i>	<i>Col. 2</i>	<i>Col. 3</i>	<i>Col. 4</i>
Aircraft	{ Lighter than air aircraft	{ Non-power driven	{ Free Balloon { Captive Balloon
		{ Power driven	{ Airship
	{ Heavier than air aircraft	{ Non-power driven	{ Glider { Kite
		{ Power driven (flying machines)	{ Aeroplane (Landplane) { Aeroplane (Seaplane) { Aeroplane (Amphibian) { Aeroplane (Self-launching Motor Glider)

Col. 1	Col. 2	Col. 3	Col. 4
			{ Rotorcraft
			{ Helicopter
			{ Gyroplane

Article 5(2)

PART B

Nationality and registration marks of aircraft registered in the Territory

1 General

(1) The nationality mark of the aircraft shall be a group of two capital letters in Roman character and the registration mark shall be a group of four capital letters in Roman character assigned by the Governor on the registration of the aircraft. The letters shall be without ornamentation and a hyphen shall be placed between the nationality mark and the registration mark.

(2) The nationality and registration marks shall be displayed to the best advantage, taking into consideration the constructional features of the aircraft and shall always be kept clean and visible.

(3) The letters constituting each group of marks shall be of equal height and they, and the hyphen, shall be of the same single colour which shall clearly contrast with the background on which they appear.

(4) The nationality and registration marks shall also be inscribed on a fire-proof metal plate affixed in a prominent position:

- (a) in the case of a microlight aeroplane, either in accordance with sub-paragraph (c) or on the wing;
- (b) in the case of a balloon, on the basket or envelope; or
- (c) in the case of any other aircraft on the fuselage or car as the case may be.

(5) The nationality and registration marks shall be painted on the aircraft or shall be affixed thereto by any other means ensuring a similar degree of permanence in the manner specified in paragraphs 2 and 3 of this Part.

2 Position and size of marks

(1) The position and size of marks on heavier than air aircraft (excluding kites) shall be as follows:

- (a) on the horizontal surfaces of the wings:
 - (i) on aircraft having a fixed wing surface, the marks shall appear on the lower surface of the wing structure and shall be on the port wing unless they extend across the whole surface of both wings. So far as is possible the marks shall be located equidistant from the leading and trailing edges of the wings. The tops of the letters shall be towards the leading edge of the wing;
 - (ii) the height of the letters shall be:
 - (aa) subject to sub-paragraph (bb), at least 50 centimetres,
 - (bb) if the wings are not large enough for the marks to be 50 centimetres in height, marks of the greatest height practicable in the circumstances;
- (b) on the fuselage (or equivalent structure) and vertical tail surfaces:
 - (i) the marks shall also appear either:

Status: This is the original version (as it was originally made). This item of legislation is currently only available in its original format.

- (aa) on each side of the fuselage (or equivalent structure), and shall, in the case of fixed wing aircraft, be located between the wings and the horizontal tail surface; or
 - (bb) on the vertical tail surfaces;
 - (ii) when located on a single vertical tail surface, the marks shall appear on both sides. When located on multi-vertical tail surfaces, the marks shall appear on the outboard sides of the outer surfaces. Subject to sub-paragraphs (iv) and (v), the height of the letters constituting each group of marks shall be at least 30 centimetres;
 - (iii) if one of the surfaces authorised for displaying the required marks is large enough for those marks to be 30 centimetres in height (whilst complying with sub-paragraph (v)) and the other is not, marks of 30 centimetres in height shall be placed on the largest authorised surface;
 - (iv) if neither authorised surface is large enough for marks of 30 centimetres in height (whilst complying with sub-paragraph (v)), marks of the greatest height practicable in the circumstances shall be displayed on the larger of the two authorised surfaces;
 - (v) the marks on the vertical tail surfaces shall be such as to leave a margin of at least five centimetres along each side of the vertical tail surface;
 - (vi) on rotary wing aircraft where owing to the structure of the aircraft the greatest height practicable for the marks on the side of the fuselage (or equivalent structure) is less than 30 centimetres, the marks shall also appear on the lower surface of the fuselage as close to the line of symmetry as is practicable and shall be placed with the tops of the letters towards the nose. The height of the letters constituting each group of marks shall be:
 - (aa) subject to sub-paragraph (bb), at least 50 centimetres; or
 - (bb) if the lower surface of the fuselage is not large enough for the marks to be of 50 centimetres in height, marks of the greatest height practicable in the circumstances;
 - (c) wherever in this paragraph marks of the greatest height practicable in the circumstances are required, that height shall be such as is consistent with compliance with paragraph 3 of this Part.
- (2) The position and size of marks on airships and free balloons shall be as follows:
- (a) in the case of airships the marks shall be placed on each side of the airship. They shall be placed horizontally either on the hull near the maximum cross-section of the airship or on the lower vertical stabiliser;
 - (b) in the case of free balloons, the marks shall be in two places on diametrically opposite sides of the balloon;
 - (c) in the case of both airships and free balloons the side marks shall be so placed as to be visible from the sides and from the ground. The height of the letters shall be at least 50 centimetres.

3 Width, spacing and thickness of marks

- (1) For the purposes of this paragraph:
 - (a) “standard letter” shall mean any letter other than the letters I, M and W;
 - (b) the width of each standard letter and the length of the hyphen between the nationality mark and the registration mark shall be two thirds of the height of a letter;

- (c) the width of the letters M and W shall be neither less than two thirds of their height nor more than their height; and
 - (d) the width of the letter I shall be one sixth of the height of the letter.
- (2) The thickness of the lines comprising each letter and hyphen shall be one sixth of the height of the letters forming the marks.
- (3) Each letter and hyphen shall be separated from the letter or hyphen which it immediately precedes or follows by a space equal to either one quarter or one half of the width of a standard letter. Each such space shall be equal to every other such space within the marks.
- Article 4(8)

PART C

Aircraft dealer's certificate—conditions

- (1) The operator of the aircraft shall be the registered owner of the aircraft, who shall be the holder of an aircraft dealer's certificate granted under this Order.
- (2) The aircraft shall fly only for the purpose of:
- (a) testing the aircraft;
 - (b) demonstrating the aircraft with a view to the sale of that aircraft or of other similar aircraft;
 - (c) proceeding to or from a place at which the aircraft is to be tested or demonstrated as aforesaid, or overhauled, repaired or modified;
 - (d) delivering the aircraft to a person who has agreed to buy, lease or sell it; or
 - (e) proceeding to or from a place for the purpose of storage.
- (3) Without prejudice to article 43 of this Order the operator of the aircraft shall satisfy himself before the aircraft takes off that the aircraft is in every way fit for the intended flight.
- (4) The aircraft shall fly only within the Territory.

SCHEDULE 3

Articles 3(2), 5(4), 8(2) and 55(7)

PART A

A and B Conditions

The A and B Conditions referred to in Articles 3(2), 5(4), 8(2) and 55(7) of this Order are as follows:

A Conditions

- (1) An aircraft registered in the Territory may fly for a purpose set out in paragraph (2) subject to the conditions contained in paragraphs (3) to (8) when either:
- (a) it does not have a certificate of airworthiness duly issued or rendered valid under the law of the Territory; or
 - (b) the certificate of airworthiness or certificate of validation issued in respect of the aircraft has ceased to be in force by virtue of any of the matters specified in Article 9(7) of this Order.

Status: This is the original version (as it was originally made). This item of legislation is currently only available in its original format.

- (a) (2) (a) In the case of an aircraft falling within paragraph (1)(a) the aircraft shall fly only for the purpose of enabling it to:
- (i) qualify for the issue or renewal of a certificate of airworthiness or the validation thereof after an application has been made for such issue, renewal or validation as the case may be, or carry out a functional check of a previously approved modification of the aircraft (and for the purpose of this Schedule “a previously approved modification” shall mean a modification which has previously been approved by the Governor in respect of that aircraft or another aircraft of the same type);
 - (ii) proceed to or from a place at which any inspection, repair, modification, maintenance, approval, test or weighing of, or the installation of equipment in, the aircraft is to take place or has taken place for a purpose referred to in subparagraph (a), after any relevant application has been made, or at which the installation of furnishings in, or the painting of, the aircraft is to be undertaken; or
 - (iii) proceed to or from a place at which the aircraft is to be or has been stored.
- (b) In the case of an aircraft falling within paragraph (1)(b), it shall fly only for the purpose of enabling it to:
- (i) proceed to a place at which any inspection or maintenance required by virtue of Article 9(7)(b)(ii) of this Order is to take place; or
 - (ii) proceed to a place at which any inspection, maintenance or modification required by virtue of Article 9(7)(b)(i) or (c) of this Order is to take place and in respect of which flight the Governor has given permission in writing; or
 - (iii) carry out a functional check, test or in-flight adjustment in connection with the carrying out in a manner approved by the Governor of any overhaul, repair, previously approved modification, inspection or maintenance required by virtue of Article 9(7) of this Order.
- (3) The aircraft shall be:
- (a) an aircraft in respect of which a certificate of airworthiness or validation has previously been in force under this Order and has not subsequently had any modification which requires approval unless that modification is a previously approved modification which has been granted such an approval under the law of the country in which the aircraft was registered at that time; or
 - (b) an aircraft identical in design (including any modifications) with an aircraft in respect of which such a certificate is or has been in force.
- (4) The aircraft and its engines shall be certified as fit for flight by the holder of an aircraft maintenance engineer’s licence granted under this Order, being a licence which entitles him to issue that certificate or by a person approved by the Governor for the purpose of issuing certificates under this condition, and in accordance with that approval.
- (5) The aircraft shall carry the minimum flight crew specified in any certificate of airworthiness or validation which has previously been in force under the Order in respect of the aircraft, or is or has previously been in force in respect of any other aircraft of identical design.
- (6) The aircraft shall not carry any persons or cargo except persons performing duties in the aircraft in connection with the flight or persons who are carried in the aircraft to perform duties in connection with a purpose referred to in paragraph (2).
- (7) The aircraft shall not fly over any congested area of a city, town or settlement except to the extent that it is necessary to do so in order to take off or land.
- (8) Without prejudice to article 20(2) of this Order, the aircraft shall carry such flight crew as may be necessary to ensure the safety of the aircraft.

B Conditions

(1) An aircraft may fly for a purpose set out in paragraph (2) subject to the conditions set out in paragraphs (3) to (8) whether or not it is registered in accordance with article 3(1) of this Order and when there is not in force in respect thereof:

- (a) in the case of an aircraft which is so registered, a certificate of airworthiness duly issued or rendered valid under the law of the country in which the aircraft is registered; or
- (b) in the case of an aircraft which is not so registered, either a certificate of airworthiness duly issued or rendered valid under the law of the Territory or a permit to fly issued by the Governor in respect of that aircraft.

(2) The aircraft shall fly only for the purpose of:

- (a) experimenting with or testing, the aircraft (including any engines installed thereon) or any equipment installed or carried in the aircraft;
- (b) enabling it to qualify for the issue of a certificate of airworthiness or the validation thereof or the approval of a modification of the aircraft or the issue of a permit to fly;
- (c) demonstrating and displaying the aircraft, any engines installed thereon or any equipment installed or carried in the aircraft with a view to the sale thereof or of other similar aircraft, engines or equipment;
- (d) demonstrating and displaying the aircraft to employees of the operator;
- (e) the giving of flying training to or the testing of flight crew employed by the operator or the training or testing of other persons employed by the operator and who are carried or are intended to be carried pursuant to paragraph (7)(a); or
- (f) proceeding to or from a place at which any experiment, inspection, repair, modification, maintenance, approval, test or weighing of the aircraft, the installation of equipment in the aircraft, demonstration, display or training is to take place for a purpose referred to in subparagraphs (a), (b), (c), (d) or (e) or at which installation of furnishings in, or the painting of, the aircraft is to be undertaken.

(3) The flight shall be operated by a person approved by the Governor for the purposes of these Conditions and subject to any additional conditions which may be specified in such an approval.

(4) If not registered in the Territory the aircraft shall be marked in a manner approved by the Governor for the purposes of these Conditions, and articles 15, 17, 43, 46, 76 and 78 of this Order shall be complied with in relation to the aircraft as if it was registered in the Territory.

(5) Without prejudice to article 20(2) of this Order, the aircraft shall carry such flight crew as may be necessary to ensure the safety of the aircraft.

(6) No person shall act as pilot in command of the aircraft except a person approved for the purpose by the Governor.

(7) The aircraft shall not carry any cargo, or any persons other than the flight crew except the following:

- (a) persons employed by the operator who during the flight carry out duties or are tested or receive training in connection with a purpose specified in paragraph (2);
- (b) persons acting on behalf of the manufacturers of component parts of the aircraft (including its engines) or of equipment installed in or carried in the aircraft for carrying out during the flight duties in connection with a purpose so specified;
- (c) persons approved by the Governor under article 134 of this Order as qualified to furnish reports for the purposes of article 9 of this Order;

Status: This is the original version (as it was originally made). This item of legislation is currently only available in its original format.

- (d) persons other than those carried under the preceding provisions of this sub-paragraph who are carried in the aircraft in order to carry out a technical evaluation of the aircraft or its operation;
 - (e) cargo which comprises equipment carried in connection with a purpose specified in paragraph (2)(f); or
 - (f) persons employed by the operator or persons acting on behalf of the manufacturers of component parts of the aircraft (including its engines) or of equipment installed in or carried in the aircraft in connection with a purpose specified in paragraph (2)(f) which persons have duties in connection with that purpose.
- (8) The aircraft shall not fly, except in accordance with procedures which have been approved by the Governor in relation to that flight, over any congested area of a city, town or settlement.
- Article 9

PART B

<i>Categories of certificate of airworthiness</i>	<i>Purpose for which the aircraft may fly</i>
Transport Category (Passenger)	Any purpose
Transport Category (Cargo)	Any purpose other than the public transport of passengers
Aerial Work Category	Any purpose other than public transport
Private Category	Any purpose other than public transport or aerial work
Special Category	Any purpose, other than public transport, specified in the certificate of airworthiness but not including the carriage of passengers unless expressly permitted.

SCHEDULE 4

Articles 12(6), 14(2) and (8),31(5), 53(1),
(3) and (4)

Aircraft equipment

- (a) (1) (a) Every aircraft of a description specified in the first column of the Table set forth in paragraph 4 of this Schedule and which is registered in the Territory shall be provided, when flying in the circumstances specified in the second column of the said Table, with adequate equipment, and for the purpose of this paragraph the expression “adequate equipment” shall mean, subject to sub-paragraph (b), the scales of equipment respectively indicated in that Table.
 - (b) If the aircraft is flying in a combination of such circumstances, the scales of equipment shall not on that account be required to be duplicated.
- (2) The equipment carried in an aircraft as being necessary for the airworthiness of the aircraft shall be taken into account in determining whether this Schedule is complied with in respect of that aircraft.
- (3) The following items of equipment shall not be required to be of a type approved by the Governor:

Status: This is the original version (as it was originally made). This item of legislation is currently only available in its original format.

- (a) The equipment referred to in Scale A (ii).
- (b) First aid equipment and handbook, referred to in Scale A.
- (c) Time-pieces, referred to in Scale F.
- (d) Torches, referred to in Scales G, H, K and Z.
- (e) Whistles, referred to in Scale H.
- (f) Sea anchors, referred to in Scales J and K.
- (g) Rocket signals, referred to in Scale J.
- (h) Equipment for mooring, anchoring or manoeuvring aircraft on the water, referred to in Scale J.
- (i) Paddles, referred to in Scale K.
- (j) Food and water, referred to in Scales K, U and V.
- (k) First aid equipment, referred to in Scales K, U and V.
- (l) Stoves, cooking utensils, snow shovels, ice saws, sleeping bags and Arctic suits, referred to in Scale V.
- (m) Megaphones, referred to in Scale Y.

4 Table

4.

4.

<i>Description of aircraft</i>	<i>Circumstances of flight</i>	<i>Scale of equipment required</i>
(1) Gliders	(a) (a) <i>flying for purposes other than public transport or aerial work; and when flying by night</i>	A (ii)
	(b) (b) <i>flying for the purpose of public transport or aerial work; and</i>	A, B (i) and (ii), D and F (i)
	(i) when flying by night	C and G
	(ii) when carrying out aerobatic manoeuvres	B (iii)
(2) Aeroplanes	(a) (a) <i>flying for purposes other than public transport; and</i>	A (i) and (ii) and B (i)
	(i) when flying by night	C and D
	(ii) when flying under Instrument Flight Rules:	

* For the purpose of this Table, flying time shall be calculated on the assumption that the aircraft is flying in still air at the speed specified in the relevant certificate of airworthiness as the speed for compliance with regulations governing flights over water.

Status: This is the original version (as it was originally made). This item of legislation is currently only available in its original format.

<i>Description of aircraft</i>	<i>Circumstances of flight</i>	<i>Scale of equipment required</i>
	(aa) outside controlled airspace	D
	(bb) within Class A, B or C airspace	E with E (iv) duplicated and F
	(cc) within Class D and E airspace	E and F
	(iii) when carrying out aerobatic manoeuvres	B (iii)
	(b) (b) <i>flying for the purpose of public transport; and</i>	A, B (i) and (ii), D and F (i)
	(i) when flying under Instrument Flight Rules except flights outside controlled airspace in the case of aeroplanes having a maximum total weight authorised not exceeding 1150 kg	E with E (iv) duplicated and F
	(ii) when flying by night; and in the case of aeroplanes of which the maximum total weight authorised exceeds 1150 kg	C and G, E with E (iv) duplicated and F
	(iii) when flying over water beyond gliding distance from land	H
	(iv) on all flights on which in the event of any emergency occurring during the take-off or during the landing at the intended destination or any likely alternate destination it is reasonably possible that the aeroplane would be forced to land onto water	H
	(v) when flying over water:	
	(aa) in the case of an aeroplane:	
	(aaa)	

* For the purpose of this Table, flying time shall be calculated on the assumption that the aircraft is flying in still air at the speed specified in the relevant certificate of airworthiness as the speed for compliance with regulations governing flights over water.

Status: This is the original version (as it was originally made). This item of legislation is currently only available in its original format.

<i>Description of aircraft</i>	<i>Circumstances of flight</i>	<i>Scale of equipment required</i>
	classified in its certificate of airworthiness as being of performance group A, C or X; or	
	(bbb) having no performance group classification in its certificate of airworthiness and of such a weight and performance that with any one of its power units inoperative and the remaining power unit or units operating within the maximum continuous power conditions specified in the certificate of airworthiness, performance schedule or flight manual relating to the aeroplane issued or rendered valid by the Governor it is capable of a gradient of climb of at least 1 in 200 at an altitude of 5000 ft in the International Standard Atmosphere specified in or ascertainable by reference to the certificate of airworthiness in force in respect of that aircraft;	
	when either more than 400 nautical miles or more than 90 minutes flying time* from the nearest aerodrome at which an emergency landing can be made	H and K
	(bb) in the case of all other aeroplanes, when more than 30 minutes flying time* from such an aerodrome	H and K
	(vi) on all flights which involve manoeuvres on water	H, J and K
	(vii) when flying at a height of 10,000 ft or more above mean sea level:	
	(aa) having a certificate of airworthiness	L1 or L2

* For the purpose of this Table, flying time shall be calculated on the assumption that the aircraft is flying in still air at the speed specified in the relevant certificate of airworthiness as the speed for compliance with regulations governing flights over water.

Status: This is the original version (as it was originally made). This item of legislation is currently only available in its original format.

<i>Description of aircraft</i>	<i>Circumstances of flight</i>	<i>Scale of equipment required</i>
	first issued (whether in the Territory or elsewhere) before 1st January 1989	
	(bb) having a certificate of airworthiness first issued (whether in the Territory or elsewhere) on or after 1st January 1989	L2
	(viii) on flights when the weather reports or forecasts available at the aerodrome at the time of departure indicate that conditions favouring ice formation are likely to be met	M
	(ix) when carrying out acrobatic manoeuvres	B (iii)
	(x) on all flights on which the aircraft carries a flight crew of more than one person	N
	(xi) on all flights for the purpose of the public transport of passengers	Q and Y (i), (ii) and (iii)
	(xii) on all flights by a pressurised aircraft	R
	(xiii) when flying over substantially uninhabited land areas where, in the event of an emergency landing tropical conditions are likely to be met	U
	(xiv) when flying over substantially uninhabited land or other areas where, in the event of an emergency landing, polar conditions are likely to be met	V
<p>* For the purpose of this Table, flying time shall be calculated on the assumption that the aircraft is flying in still air at the speed specified in the relevant certificate of airworthiness as the speed for compliance with regulations governing flights over water.</p>		

Status: This is the original version (as it was originally made). This item of legislation is currently only available in its original format.

<i>Description of aircraft</i>	<i>Circumstances of flight</i>	<i>Scale of equipment required</i>
	(xv) when flying at an altitude of more than 49,000 ft	W
(3) Turbine-jet aeroplanes having a maximum total weight authorised exceeding 5,700 kg or pressurised aircraft having a maximum total weight authorised exceeding 11,400 kg.	<i>When flying for the purpose of public transport</i>	O
(4) Turbine-engined aeroplanes having a maximum total weight authorised exceeding 5,700 kg and piston engined aeroplanes having a maximum total weight authorised exceeding 27,000 kg except for such aeroplanes falling within paragraphs (5) and (6):		
(a) (a) which are operated by an air transport undertaking under a certificate of airworthiness in the Transport Category (Passenger) or the Transport Category (cargo); or	<i>When flying on any flight</i>	P
(b) (b) in respect of which application has been made and not withdrawn or refused for such a certificate, and which fly under the “A Conditions” or under a certificate of airworthiness in the Special Category	<i>When flying on any flight</i>	P
(5) Aeroplanes in respect of which there is in force a certificate of airworthiness in the Transport Category (Passenger) or Transport Category (Cargo) and aeroplanes in respect of which application has been		

* For the purpose of this Table, flying time shall be calculated on the assumption that the aircraft is flying in still air at the speed specified in the relevant certificate of airworthiness as the speed for compliance with regulations governing flights over water.

Status: This is the original version (as it was originally made). This item of legislation is currently only available in its original format.

<i>Description of aircraft</i>	<i>Circumstances of flight</i>	<i>Scale of equipment required</i>
made, and not withdrawn or refused, for such a certificate of airworthiness and which fly under the “A Conditions” or in respect of which there is in force a certificate of airworthiness in the Special Category except for such aeroplanes falling within paragraph (6):		
(a) (a) which conform to a type first issued with a type certificate (whether in the Territory or elsewhere) on or after 1st April 1971 and which have a maximum total weight authorised exceeding 5,700 kg but not exceeding 11,400 kg; or	<i>When flying on any flight</i>	S (i)
(b) (b) which conform to a type first issued with a type certificate (whether in the Territory or elsewhere) on or after 1st April 1971 and which have a maximum total weight authorised exceeding 11,400 kg but not exceeding 27,000 kg; or	<i>When flying on any flight</i>	S (ii)
(c) (c) which conform to a type first issued with a type certificate (whether in the Territory or elsewhere) on or after 1st April 1971 and which have a maximum total weight authorised exceeding 27,000 kg	<i>When flying on any flight</i>	S (iii)

* For the purpose of this Table, flying time shall be calculated on the assumption that the aircraft is flying in still air at the speed specified in the relevant certificate of airworthiness as the speed for compliance with regulations governing flights over water.

Status: This is the original version (as it was originally made). This item of legislation is currently only available in its original format.

<i>Description of aircraft</i>	<i>Circumstances of flight</i>	<i>Scale of equipment required</i>
but not exceeding 230,000 kg; or		
(d) (d) which conform to a type first issued with a type certificate (whether in the Territory or elsewhere) on or after 1st January 1970 and which have a maximum total weight authorised exceeding 230,000 kg;	<i>When flying on any flight</i>	S (iii)
(6) Aeroplanes in respect of which there is in force a certificate of airworthiness in the Transport Category (Passenger) or Transport Category (Cargo) and aeroplanes in respect of which application has been made, and not withdrawn or refused, for such a certificate of airworthiness and which fly under “A Conditions” or in respect of which there is in force a certificate of airworthiness in the Special Category:		
(a) (a) for which an individual certificate of airworthiness was first issued (whether in the Territory or elsewhere) on or after 1st June 1990 and which have a maximum total weight authorised not exceeding 5,700 kg, are powered by 2 or more turbine engines and are certified to carry more than 9 passengers; or	<i>When flying on any flight</i>	S (iv)
(b) (b) for which an individual certificate	<i>When flying on any flight</i>	S (v)

* For the purpose of this Table, flying time shall be calculated on the assumption that the aircraft is flying in still air at the speed specified in the relevant certificate of airworthiness as the speed for compliance with regulations governing flights over water.

Status: This is the original version (as it was originally made). This item of legislation is currently only available in its original format.

<i>Description of aircraft</i>	<i>Circumstances of flight</i>	<i>Scale of equipment required</i>
of airworthiness was first issued (whether in the Territory or elsewhere) on or after 1st June 1990 and which have a maximum total weight authorised exceeding 5,700 kg but not exceeding 27,000 kg; or		
(c) (c) for which an individual certificate of airworthiness was first issued (whether in the Territory or elsewhere) on or after 1st June 1990 and which have a maximum total weight authorised exceeding 27,000 kg.	<i>When flying on any flight</i>	S (vi)
(7) Aeroplanes in respect of which there is in force a certificate of airworthiness in the Aerial Work or Private Category and for which an individual certificate of airworthiness was first issued (whether in the Territory or elsewhere) on or after 1st June 1990 and which have a maximum total weight authorised exceeding 27,000 kg.	<i>When flying on any flight</i>	S (vi)
(8) Aeroplanes:		
(a) (a) which conform to a type first issued with a type certificate (whether in the Territory or elsewhere) on or after 1st April 1971 and having a maximum total weight authorised exceeding 27,000 kg	<i>When flying on any flight</i>	T

* For the purpose of this Table, flying time shall be calculated on the assumption that the aircraft is flying in still air at the speed specified in the relevant certificate of airworthiness as the speed for compliance with regulations governing flights over water.

Status: This is the original version (as it was originally made). This item of legislation is currently only available in its original format.

<i>Description of aircraft</i>	<i>Circumstances of flight</i>	<i>Scale of equipment required</i>
and in respect of which there is in force a certificate of airworthiness in the Transport Category (Passenger) or the Transport Category (Cargo); or		
(b) (b) which conform to a type first issued with a type certificate in the Territory on or after 1st January 1970 and which have a maximum total weight authorised exceeding 230,000 kg and in respect of which there is in force such a certificate of airworthiness; or	<i>When flying on any flight</i>	T
(c) (c) having a maximum total weight authorised exceeding 27,000 kg which conform to a type first issued with a type certificate on or after 1st April 1971 (or 1st January 1970 in the case of an aeroplane having a maximum total weight authorised exceeding 230,000 kg) in respect of which an application has been made, and not withdrawn or refused for such a certificate of airworthiness and which fly under the “A Conditions” or in respect of which there is in force a certificate	<i>When flying on any flight</i>	T

* For the purpose of this Table, flying time shall be calculated on the assumption that the aircraft is flying in still air at the speed specified in the relevant certificate of airworthiness as the speed for compliance with regulations governing flights over water.

Status: This is the original version (as it was originally made). This item of legislation is currently only available in its original format.

<i>Description of aircraft</i>	<i>Circumstances of flight</i>	<i>Scale of equipment required</i>
<p>of airworthiness in the Special Category</p> <p>(9) Aeroplanes powered by one or more turbine jets or one or more turbine propeller engines and which have a maximum total weight authorised exceeding 15,000 kg or which in accordance with the certificate of airworthiness in force in respect thereof may carry more than 30 passengers:</p> <p>(a) (a) except any such aeroplanes as come within sub-paragraph (b)</p> <p>(b) (b) for which an individual certificate of airworthiness was first issued (whether in the Territory or elsewhere) on or after 1st July 2001</p> <p>(c) (c) for which an individual certificate of airworthiness was first issued (whether in the Territory or elsewhere) before 1st July 2001</p> <p>(10) Aeroplanes which are powered by one or more turbine jets or one or more turbine propeller engines and which have a maximum total weight authorised exceeding 5,700 kg but not exceeding 15,000 kg or which in accordance with the certificate of airworthiness in force in respect thereof may carry more than 9 passengers but not exceeding 30 passengers:</p> <p>(a) (a) except any such aeroplanes as</p>	<p><i>When flying for the purpose of public transport prior to 1st January 2005</i></p> <p><i>When flying for the purpose of public transport</i></p> <p><i>When flying for the purpose of public transport on or after 1st January 2005</i></p> <p><i>When flying for the purpose of public transport on or after 1st October 2001, except when</i></p>	<p>X (i)</p> <p>X (ii)</p> <p>X (ii)</p> <p>X (ii)</p>

* For the purpose of this Table, flying time shall be calculated on the assumption that the aircraft is flying in still air at the speed specified in the relevant certificate of airworthiness as the speed for compliance with regulations governing flights over water.

Status: This is the original version (as it was originally made). This item of legislation is currently only available in its original format.

<i>Description of aircraft</i>	<i>Circumstances of flight</i>	<i>Scale of equipment required</i>
come within sub-paragraph (b)	<i>flying under and in accordance with the terms of a police air operator's certificate</i>	
(b) (b) which have equipment capable of giving warning to the pilot of the potentially hazardous proximity of ground or water installed before 1st April 2000	<i>When flying for the purpose of public transport on or after 1st January 2005, except when flying under and in accordance with the terms of a police air operator's certificate</i>	X (ii)
(11) Aeroplanes which are powered by one or more turbine jets or one or more turbine propeller engines and which have a maximum total weight authorised exceeding 5,700 kg or which in accordance with the certificate of airworthiness in force in respect thereof may carry more than 9 passengers:		
(a) (a) in respect of which there is in force a certificate of airworthiness except any such aeroplanes as come within sub-paragraph (b)	<i>When flying for the purpose of public transport on or after 1st October 2001</i>	X (ii)
(b) (b) in respect of which there is in force a certificate of airworthiness and which have equipment capable of giving warning to the pilot of the potentially hazardous proximity of ground or water installed before 1st April 2000.	<i>When flying for the purpose of public transport on or after 1st January 2005</i>	X (ii)
(12) Aeroplanes:		
(a) (a) powered by one more turbo-jets and which have a maximum total weight authorised	<i>When flying by night for the purpose of the public transport of passengers</i>	Z (i) and (ii)

* For the purpose of this Table, flying time shall be calculated on the assumption that the aircraft is flying in still air at the speed specified in the relevant certificate of airworthiness as the speed for compliance with regulations governing flights over water.

Status: This is the original version (as it was originally made). This item of legislation is currently only available in its original format.

<i>Description of aircraft</i>	<i>Circumstances of flight</i>	<i>Scale of equipment required</i>
<p>exceeding 22,700 kg; or</p> <p>(b) (b) having a maximum total weight authorised exceeding 5,700 kg, and which conform to a type for which a certificate of airworthiness was first applied for (whether in the Territory or elsewhere) after 30th April 1972 but not including any aeroplane which in the opinion of the Governor is identical in all matters affecting the provision of emergency evacuation facilities to an aeroplane for which a certificate of airworthiness was first applied for before that date; or</p>	<p><i>When flying by night for the purpose of the public transport of passengers</i></p>	<p>Z (i) and (ii)</p>
<p>(c) (c) which in accordance with the certificate of airworthiness in force in respect thereof may carry more than 19 passengers; or</p>	<p><i>When flying by night for the purpose of the public transport of passengers</i></p>	<p>Z (i)</p>
<p>(d) (d) having a maximum total weight authorised exceeding 5,700 kg, and which conform to a type for which a certificate of airworthiness was first applied for (whether in the Territory or</p>	<p><i>When flying for the purpose of the public transport of passengers</i></p>	<p>Z (iii)</p>

* For the purpose of this Table, flying time shall be calculated on the assumption that the aircraft is flying in still air at the speed specified in the relevant certificate of airworthiness as the speed for compliance with regulations governing flights over water.

Status: This is the original version (as it was originally made). This item of legislation is currently only available in its original format.

<i>Description of aircraft</i>	<i>Circumstances of flight</i>	<i>Scale of equipment required</i>
elsewhere) after 30th April 1972 but not including any aeroplane which in the opinion of the Governor is identical in all matters affecting the provision of emergency evacuation facilities to an aeroplane for which a certificate of airworthiness was first applied for before that date; or		
(e) (e) powered by one or more turbo-jets and which have a maximum total weight authorised exceeding 22,700 kg; or	<i>When flying by night for the purpose of the public transport of passengers</i>	Z (iii)
(f) (f) first issued with a type certificate (whether in the Territory or elsewhere) on or after 1st January 1958 and which in accordance with the certificate of airworthiness in force in respect thereof may carry more than 19 passengers	<i>When flying for the purpose of the public transport of passengers</i>	Z (iii)
(13) Aeroplanes:		
(a) (a) powered by one or more turbine jets	<i>When flying on any flight</i>	AA
(b) (b) powered by one or more turbine propeller engines and having a maximum total weight authorised exceeding 5700 kg	<i>When flying on any flight</i>	AA

* For the purpose of this Table, flying time shall be calculated on the assumption that the aircraft is flying in still air at the speed specified in the relevant certificate of airworthiness as the speed for compliance with regulations governing flights over water.

Status: This is the original version (as it was originally made). This item of legislation is currently only available in its original format.

<i>Description of aircraft</i>	<i>Circumstances of flight</i>	<i>Scale of equipment required</i>
and first issued with a certificate of airworthiness in the Territory on or after 1st April 1989		
(14) Aeroplanes in respect of which there is in force a certificate of airworthiness in the Transport Category (Passenger)	<i>When flying for the purpose of the public transport of passengers</i>	Y (iv)
(15) Helicopters and Gyroplanes	(a) (a) Flying for purposes other than public transport: and (i) when flying by day under Visual Flight Rules with visual ground reference (ii) when flying by day under Instrument Flight Rules or without visual ground reference (aa) outside controlled airspace (bb) within controlled airspace (iii) when flying at night (aa) with visual ground reference (bb) without visual ground reference (aaa) outside controlled airspace (bbb) within controlled airspace (b) (b) flying for the purpose of public transport; and (i) when flying by day under Visual Flight Rules with visual ground reference	A (i) and (ii) and B (i) D E with E (ii) duplicated E with both E (ii) and E (iv) duplicated and F with F (iv) for all weights C, E, G (iii) and G (v) C, E and E (ii) duplicated G (iii) and G (v) C, E with both E (ii) and E (iv) duplicated, F with F (iv) for all weights, G (iii) and G (v) A, B (i) and (ii). F (i) and F (iv) for all weights

* For the purpose of this Table, flying time shall be calculated on the assumption that the aircraft is flying in still air at the speed specified in the relevant certificate of airworthiness as the speed for compliance with regulations governing flights over water.

Status: This is the original version (as it was originally made). This item of legislation is currently only available in its original format.

<i>Description of aircraft</i>	<i>Circumstances of flight</i>	<i>Scale of equipment required</i>
	(ii) when flying by day under Instrument Flight Rules or without visual ground reference	E with both E (ii) and E (iv) duplicated, F (ii), F (iii) and F (v)
	(iii) when flying by night with visual ground reference	
	(aa) when flying with one pilot	C, E with E (ii) duplicated and either E (iv) duplicated or a radio altimeter, F (ii), F (iii), F (v) and G
	(bb) when flying in circumstances where two pilots are required	C, E, F (ii), F (iii), F (v) and G for each pilot's station
	(iv) when flying by night without visual ground reference	C, E with both E (ii) and E (iv) duplicated, F (ii), F (iii), F (v) and G
	(v) when flying over water	
	(aa) in the case of a helicopter or gyroplane classified in its certificate of airworthiness as being of performance group A2 or B when beyond autorotational gliding distance from land suitable for an emergency landing	E and H
	(bb) on all flights on which in the event of any emergency occurring during the take-off or during the landing at the intended destination or any likely alternate destination it is reasonably possible that the helicopter or gyroplane would be forced to land onto water	H
	(cc) in the case of a helicopter or	E, H, K and T

* For the purpose of this Table, flying time shall be calculated on the assumption that the aircraft is flying in still air at the speed specified in the relevant certificate of airworthiness as the speed for compliance with regulations governing flights over water.

Status: This is the original version (as it was originally made). This item of legislation is currently only available in its original format.

<i>Description of aircraft</i>	<i>Circumstances of flight</i>	<i>Scale of equipment required</i>
	gyroplane classified in its certificate of airworthiness as being of performance group A2 when beyond 10 minutes flying time* from land	
	(dd) for more than a total of 3 minutes in any flight	EE
	(ee) in the case of a helicopter or a gyroplane classified in its certificate of airworthiness as being of performance group A2 which is intended to fly beyond 10 minutes flying time* from land or which actually flies beyond 10 minutes flying time from land, on a flight which is either in support of or in connection with the offshore exploitation, or exploration of mineral resources (including gas) or is on a flight under and in accordance with the terms of a police air operator's certificate, when in either case the weather reports or forecasts available to the commander of the aircraft indicate that the sea temperature will be less than plus 10°C during the flight or when any part of the flight is at night	I
	(vi) on all flights which involve manoeuvres on water	H, J and K

* For the purpose of this Table, flying time shall be calculated on the assumption that the aircraft is flying in still air at the speed specified in the relevant certificate of airworthiness as the speed for compliance with regulations governing flights over water.

Status: This is the original version (as it was originally made). This item of legislation is currently only available in its original format.

<i>Description of aircraft</i>	<i>Circumstances of flight</i>	<i>Scale of equipment required</i>
	(vii) when flying at a height of 10,000 ft or more above mean sea level:	
	(aa) having a certificate of airworthiness first issued (whether in the Territory or elsewhere) before 1st January 1989	L1 or L2
	(bb) having a certificate of airworthiness first issued (whether in the Territory or elsewhere) on or after 1st January 1989	L2
	(viii) on flights when the weather reports or forecasts available at the aerodrome at the time of departure indicate that conditions favouring ice formation are likely to be met	M
	(ix) on all flights on which the aircraft carries a flight crew of more than one person	N
	(x) on all flights for the purpose of the transport of passengers	Y (i), (ii) and (iii)
	(xi) when flying over substantially uninhabited land areas where, in the event of an emergency landing, tropical conditions are likely to be met	U
	(xii) when flying over substantially uninhabited land or other areas where, in the event of an emergency landing, polar conditions are likely to be met	V
* For the purpose of this Table, flying time shall be calculated on the assumption that the aircraft is flying in still air at the speed specified in the relevant certificate of airworthiness as the speed for compliance with regulations governing flights over water.		

Status: This is the original version (as it was originally made). This item of legislation is currently only available in its original format.

<i>Description of aircraft</i>	<i>Circumstances of flight</i>	<i>Scale of equipment required</i>
(16) Helicopters and Gyroplanes:		
(a) (a) having a maximum total weight authorised exceeding 5700 kg and which conform to a type for which a certificate of airworthiness was first applied for (whether in the Territory or elsewhere) after 30th April 1972 but not including any helicopter or gyroplane which in the opinion of the Governor is identical in all matters affecting the provision of emergency evacuation facilities to a helicopter or gyroplane for which a certificate of airworthiness was first applied for before that date; or	<i>When flying by night for the purpose of the public transport of passengers</i>	Z (i) and (ii)
(b) (b) which, in accordance with the certificate of airworthiness in force in respect thereof may carry more than 19 passengers, or	<i>When flying by night for the purpose of the public transport of passengers</i>	Z (i)
(c) (c) which have a certificate of airworthiness issued in the Transport Category (Passenger or Cargo) and helicopters and gyroplanes in respect of which application		

* For the purpose of this Table, flying time shall be calculated on the assumption that the aircraft is flying in still air at the speed specified in the relevant certificate of airworthiness as the speed for compliance with regulations governing flights over water.

Status: This is the original version (as it was originally made). This item of legislation is currently only available in its original format.

<i>Description of aircraft</i>	<i>Circumstances of flight</i>	<i>Scale of equipment required</i>
has been made and not withdrawn or refused for such a certificate of airworthiness and which fly under the "A Conditions" or which have a certificate of airworthiness in the Special Category and		
(i) which have a maximum total weight authorised exceeding 2730 kg but not exceeding 7000 kg or which in accordance with the certificate of airworthiness in force in respect thereof may carry more than 9 passengers, or both	<i>When flying on any flight</i>	SS (i) or (iii)
(ii) which have a maximum total weight authorised exceeding 7000 kg	<i>When flying on any flight</i>	SS (ii) or (iii)
* For the purpose of this Table, flying time shall be calculated on the assumption that the aircraft is flying in still air at the speed specified in the relevant certificate of airworthiness as the speed for compliance with regulations governing flights over water.		

5. The scales of equipment indicated in the foregoing Table shall be as follows:

Scale A

- (i) Spare fuses for all electrical circuits the fuses of which can be replaced in flight, consisting of 10 per cent of the number of each rating or three of each rating, whichever is the greater.
- (ii) Maps, charts, codes and other documents and navigational equipment necessary, in addition to any other equipment required under this Order, for the intended flight of the aircraft including any diversion which may reasonably be expected.
- (iii) First aid equipment of good quality, sufficient in quantity, having regard to the number of persons on board the aircraft, and including the following:
 - Roller bandages, triangular bandages, adhesive plaster, absorbent gauze, cotton wool (or wound dressings in place of the absorbent gauze and cotton wool), burn dressings, safety pins;
 - Haemostatic bandages or tourniquets, scissors;
 - Antiseptic, analgesic and stimulant drugs;
 - Splints, in the case of aeroplanes the maximum total weight authorised of which exceeds 5,700 kg;
 - A handbook on first aid.

Status: This is the original version (as it was originally made). This item of legislation is currently only available in its original format.

- (iv) In the case of a flying machine used for the public transport of passengers in which, while the flying machine is at rest on the ground, the sill of any external door intended for the disembarkation of passengers, whether normally or in an emergency:
- (a) is more than 1.82 metres from the ground when the undercarriage of the machine is in the normal position for taxiing; or
 - (b) would be more than 1.82 metres from the ground if the undercarriage or any part thereof should collapse, break or fail to function;
- apparatus readily available for use at each such door consisting of a device or devices which will enable passengers to reach the ground safely in an emergency while the flying machine is on the ground, and can be readily fixed in position for use.

Scale AA

- (i) Subject to sub-paragraph (ii), an altitude alerting system capable of alerting the pilot upon approaching a preselected altitude in either ascent or descent, by a sequence of visual and aural signals in sufficient time to establish level flight at that preselected altitude and when deviating above or below that preselected altitude, by a visual and an aural signal.
- (ii) If the system becomes unserviceable, the aircraft may fly or continue to fly, until it first lands at a place at which it is reasonably practicable for the system to be repaired or replaced.

Scale B

- (i)
 - (a) If the maximum total weight authorised of the aircraft is 2,730 kg, or less for every pilot's seat and for any seat situated alongside a pilot's seat, either a safety belt with one diagonal shoulder strap or a safety harness, or with the permission of the Governor, a safety belt without a diagonal shoulder strap which permission may be granted if the Governor is satisfied that it is not reasonably practicable to fit a safety belt with one diagonal shoulder strap or a safety harness.
 - (b) If the maximum total weight authorised of the aircraft exceeds 2,730 kg, either a safety harness for every pilot's seat and for any seat situated alongside a pilot's seat, or with the permission of the Governor, a safety belt with one diagonal shoulder strap which permission may be granted if the Governor is satisfied that it is not reasonably practicable to fit a safety harness.
 - (c) For every seat in use (not being a seat referred to in sub-paragraphs (a), (b), (e) and (f)) a safety belt with or without one diagonal shoulder strap or a safety harness.
 - (d) In addition and to be attached to or secured by the equipment required in sub-paragraph (c) above, a child restraint device for every child under the age of two years on board.
 - (e) On all flights for the public transport of passengers by aircraft, for each seat for use by cabin attendants who are required to be carried under this Order, a safety harness.
 - (f) On all flights in aeroplanes in respect of which a certificate of airworthiness was first issued (whether in the Territory or elsewhere) on or after 1st February 1989 the maximum total weight authorised of which does not exceed 5,700 kg which in accordance with the certificate of airworthiness in force thereof is not capable of seating more than 9 passengers (otherwise than in seats referred to under sub-paragraphs (a) and (b)), a safety belt with one diagonal shoulder strap or a safety harness for each seat intended for use by a passenger.
- (ii) If the commander cannot, from his own seat, see all the passengers' seats in the aircraft, a means of indicating to the passengers that seat belts should be fastened.
- (iii)
 - (a) Subject to sub-paragraph (b), a safety harness for every seat in use.

- (b) In the case of an aircraft carrying out aerobatic manoeuvres consisting only of erect spinning, the Governor may permit a safety belt with one diagonal shoulder strap to be fitted if he is satisfied that such restraint is sufficient for the carrying out of erect spinning in that aircraft and that it is not reasonably practicable to fit a safety harness in that aircraft.

Scale C

- (i) Equipment for displaying the lights required by the Rules of the Air.
- (ii) Electrical equipment, supplied from the main source of supply in the aircraft, to provide sufficient illumination to enable the flight crew properly to carry out their duties during flight.
- (iii) Unless the aircraft is equipped with radio, devices for making the visual signal specified in the Rules of the Air as indicating a request for permission to land.

Scale D

- (i)
 - (a) In the case of a helicopter or gyroplane, a slip indicator.
 - (b) In the case of any other flying machine either:
 - (aa) a turn indicator and a slip indicator; or
 - (bb) a gyroscopic bank and pitch indicator and a gyroscopic direction indicator.
- (ii) A sensitive pressure altimeter adjustable for any sea level barometric pressure which the weather report or forecasts available to the commander of the aircraft indicate is likely to be encountered during the intended flight.

Scale E

- (i)
 - (a) In the case of a helicopter or gyroplane, a slip indicator.
 - (b) In the case of any other flying machine, a slip indicator and either a turn indicator or, at the option of the operator, an additional gyroscopic bank and pitch indicator.
- (ii) A gyroscopic bank and pitch indicator.
- (iii) A gyroscopic direction indicator.
- (iv) A sensitive pressure altimeter adjustable for any sea level barometric pressure which the weather report or forecasts available to the commander of the aircraft indicate is likely to be encountered during the intended flight.

Scale EE

- (i) Subject to sub-paragraph (ii), a radio altimeter with an audio voice warning operating below a pre-set height and a visual warning capable of operating at a height selectable by the pilot.
- (ii) A helicopter flying under and in accordance with the terms of a police air operator's certificate may instead be equipped with a radio altimeter with an audio warning and a visual warning each capable of operating at a height selectable by the pilot.

Scale F

- (i) A timepiece indicating the time in hours, minutes and seconds.
- (ii) A means of indicating whether the power supply to the gyroscopic instrument is adequate.
- (iii) A rate of climb and descent indicator.
- (iv) If the maximum total weight authorised of the aircraft exceeds 5,700 kg a means of indicating outside air temperature.

Status: This is the original version (as it was originally made). This item of legislation is currently only available in its original format.

- (v) If the maximum total weight authorised of the aircraft exceeds 5,700 kg two air speed indicators.

Scale G

- (i) In the case of an aircraft other than a helicopter or gyroplane landing lights consisting of 2 single filament lamps, or one dual filament lamp with separately energised filaments.
- (ii) An electrical lighting system to provide illumination in every passenger compartment.
- (iii)
 - (a) One electric torch for each member of the crew of the aircraft; or
 - (b)
 - (aa) one electric torch for each member of the flight crew of the aircraft; and
 - (bb) at least one electric torch affixed adjacent to each floor level exit intended for the disembarkation of passengers whether normally or in an emergency, provided that such torches shall:
 - (aaa) be readily accessible for use by the crew of the aircraft at all times; and
 - (bbb) number in total not less than the minimum number of cabin attendants required to be carried with a full passenger complement.
- (iv) In the case of an aircraft other than a helicopter or gyroplane of which the maximum total weight authorised exceeds 5,700 kg, means of observing the existence and build up of ice on the aircraft.
- (v)
 - (a) In the case of a helicopter or gyroplane in respect of which there is in force a certificate of airworthiness designating the helicopter or gyroplane as being of performance group A, either:
 - (aa) two landing lights both of which are adjustable so as to illuminate the ground in front of and below the helicopter or gyroplane and one of which is adjustable so as to illuminate the ground on either side of the helicopter or gyroplane; or
 - (bb) one landing light or, if the maximum total weight authorised of the helicopter or gyroplane exceeds 5,700 kg, one dual filament landing light with separately energised filaments, or 2 single filament lights, each of which is adjustable so as to illuminate the ground in front of and below the helicopter or gyroplane, and 2 parachute flares.
 - (b) In the case of a helicopter or gyroplane in respect of which there is in force a certificate of airworthiness designating the helicopter or gyroplane as being of performance group B, either:
 - (aa) one landing light and 2 parachute flares: or
 - (bb) if the maximum total weight authorised of the helicopter or gyroplane exceeds 5,700 kg, either one dual filament landing light with separately energised filaments or 2 single filament landing lights, and 2 parachute flares.

Scale H

- (i) Subject to sub-paragraph (ii), for each person on board, a lifejacket equipped with a whistle and waterproof torch.
- (ii) Lifejackets constructed and carried solely for use by children under three years of age need not be equipped with a whistle.

Scale I

A survival suit for each member of the crew.

Scale J

- (i) Additional flotation equipment, capable of supporting one fifth of the number of persons on board, and provided in a place of stowage accessible from outside the flying machine.
- (ii) Parachute distress rocket signals capable of making, from the surface of the water, the pyrotechnical signal of distress specified in the Rules of the Air and complying with Part III of Schedule 15 to the Merchant Shipping (Life-Saving Appliances) Regulations 1980(23).
- (iii) A sea anchor and other equipment necessary to facilitate mooring, anchoring or manoeuvring the flying machine on water, appropriate to its size, weight and handling characteristics.

Scale K

- (i)
 - (a) In the case of a flying machine, other than a helicopter or gyroplane carrying 20 or more persons, liferafts sufficient to accommodate all persons on board.
 - (b) In the case of a helicopter or gyroplane carrying 20 or more persons, a minimum of 2 liferafts sufficient together to accommodate all persons on board.
- (ii) Each liferaft shall contain the following equipment:
 - (a) means for maintaining buoyancy;
 - (b) a sea anchor;
 - (c) life-lines, and means of attaching one liferaft to another;
 - (d) paddles or other means of propulsion;
 - (e) means of protecting the occupants from the elements;
 - (f) a waterproof torch;
 - (g) marine type pyrotechnical distress signals;
 - (h) means of making sea water drinkable, unless the full quantity of fresh water is carried as specified in sub-paragraph (i);
 - (i) for each 4 or proportion of 4 persons the liferaft is designed to carry:
 - (aa) 100 grammes of glucose toffee tablets; and
 - (bb) half a litre of fresh water in durable containers or in any case in which it is not reasonably practicable to carry the quantity of water above specified, as large a quantity of fresh water as is reasonably practicable in the circumstances. In no case however shall the quantity of water carried be less than is sufficient, when added to the amount of fresh water capable of being produced by means of the equipment specified in sub-paragraph (h) to provide ½ litre of water for each 4 or proportion of 4 persons the liferaft is designed to carry.
 - (j) first aid equipment.
- (iii) Items (ii)(f) to (j) inclusive shall be contained in a pack.
- (iv) The number of survival beacon radio apparatus carried when the aircraft is carrying the number of liferafts specified in column 1 of the following Table shall be not less than the number specified in, or calculated in accordance with, column 2.

(23) S.I. 1980/538.

Status: This is the original version (as it was originally made). This item of legislation is currently only available in its original format.

<i>Column 1</i>	<i>Column 2</i>
Not more than 8 liferafts	2 survival beacon radio apparatus
For every additional 4 or proportion of 4 liferafts	1 additional survival beacon radio apparatus

- (v) In the case of a helicopter or gyroplane, an emergency beacon which is automatically deployed and activated in the event of a crash.

Scale L 1

Part I

- (i) In every flying machine which is provided with means for maintaining a pressure greater than 700 hectopascals throughout the flight in the flight crew compartment and in the compartments in which the passengers are carried:
 - (a) a supply of oxygen sufficient, in the event of failure to maintain such pressure, occurring in the circumstances specified in columns 1 and 2 of the Table set out in Part II, for continuous use, during the periods specified in column 3 of the said Table, by the persons for whom oxygen is to be provided in accordance with column 4 of that Table; and
 - (b) in addition, in every case where the flying machine flies above flight level 350, a supply of oxygen in a portable container sufficient for the simultaneous first aid treatment of 2 passengers;
 together with suitable and sufficient apparatus to enable such persons to use the oxygen.
- (ii) In any other flying machine:
 - (a) a supply of oxygen sufficient for continuous use by all the crew other than the flight crew, and if passengers are carried, by 10 per cent of the number of passengers, for any period exceeding 30 minutes during which the flying machine flies above flight level 100 but not above flight level 130 and the flight crew shall be supplied with oxygen sufficient for continuous use for any period during which the flying machine flies above flight level 100; and
 - (b) a supply of oxygen sufficient for continuous use by all persons on board for the whole time during which the flying machine flies above flight level 130; together with suitable and sufficient apparatus to enable such persons to use the oxygen.
- (iii) The quantity of oxygen required for the purpose of complying with paragraphs (i) and (ii) of this Part shall be computed in accordance with the information and instructions relating thereto specified in the operations manual relating to the aircraft pursuant to item (vi) of Part A of Schedule 10 to this Order.

Part II

<i>Column 1</i> <i>Vertical displacement of the flying machine in relation to flight levels</i>	<i>Column 2</i> <i>Capability of flying machine to descend (where relevant)</i>	<i>Column 3</i> <i>Period of supply of oxygen</i>	<i>Column 4</i> <i>Persons for whom oxygen is to be provided</i>
Above flight level 100	—	30 minutes or the period specified at A	In addition to any passengers for whom oxygen is provided as

Status: This is the original version (as it was originally made). This item of legislation is currently only available in its original format.

Column 1 <i>Vertical displacement of the flying machine in relation to flight levels</i>	Column 2 <i>Capability of flying machine to descend (where relevant)</i>	Column 3 <i>Period of supply of oxygen</i>	Column 4 <i>Persons for whom oxygen is to be provided</i>
		hereunder whichever is the greater	specified below, all the crew
Above flight level 100 but not above flight level 300	{ Flying machine is either flying at or below flight level 150 or is capable of descending and continuing to destination as specified at X hereunder	30 minutes or the period specified at A hereunder whichever is the greater	10% of number of passengers
	{ Flying machine is flying above flight level 150 and is not so capable	{ 10 minutes or the period specified at B hereunder whichever is greater and in addition { 30 minutes or the period specified at C hereunder whichever is the greater	All passengers 10% of number of passengers
Above flight level 300 but not above flight level 350	{ Flying machine is capable of descending and continuing to destination as specified at Y hereunder	30 minutes or the period specified at A hereunder whichever is the greater	15% of number of passengers
	{ Flying machine is not so capable	10 minutes or the period specified at B hereunder whichever is the greater and in addition { 30 minutes or the period specified at C hereunder whichever is the greater	All passengers 15% of number of passengers
Above flight level 350	—	{ 10 minutes or the period specified at B hereunder whichever is the greater and in addition { 30 minutes or the period specified at C	All passengers 15% of number of passengers

Status: This is the original version (as it was originally made). This item of legislation is currently only available in its original format.

Column 1 <i>Vertical displacement of the flying machine in relation to flight levels</i>	Column 2 <i>Capability of flying machine to descend (where relevant)</i>	Column 3 <i>Period of supply of oxygen</i>	Column 4 <i>Persons for whom oxygen is to be provided</i>
		hereunder whichever is the greater	

- A The whole period during which, after a failure to maintain a pressure greater than 700 hectopascals in the control compartment and in the compartments in which passengers are carried has occurred, the flying machine flies above flight level 100.
- B The whole period during which, after a failure to maintain such pressure has occurred, the flying machine flies above flight level 150.
- C The whole period during which, after a failure to maintain such pressure has occurred, the flying machine flies above flight level 100, but not above flight level 150.
- X The flying machine is capable, at the time when a failure to maintain such pressure occurs, of descending in accordance with the emergency descent procedure specified in the relevant flight manual and without flying below the minimum altitudes for safe

- flight specified in the operations manual relating to the aircraft, to flight level 150 within 6 minutes, and of continuing at or below that flight level to its place of intended destination or any other place at which a safe landing can be made.
- Y The flying machine is capable, at the time when a failure to maintain such pressure occurs, of descending in accordance with the emergency descent procedure specified in the relevant flight manual and without flying below the minimum altitudes for safe flight specified in the operations manual relating to the aircraft, to flight level 150 within 4 minutes, and of continuing at or below that flight level to its place of intended destination or any other place at which a safe landing can be made.

Scale L2

A supply of oxygen and the associated equipment to meet the requirements set out in Parts I and II. The duration for the purposes of this Scale shall be:

- (i) that calculated in accordance with the operations manual prior to the commencement of the flight, being the period or periods which it is reasonably anticipated that the aircraft will be flown in the circumstances of the intended flight at a height where the said requirements apply and in calculating the said duration account shall be taken of:
 - (a) in the case of pressurised aircraft, the possibility of depressurisation when flying above flight level 100;
 - (b) the possibility of failure of one or more of the aircraft engines;
 - (c) restrictions due to required minimum safe altitude;
 - (d) fuel requirement; and

Status: This is the original version (as it was originally made). This item of legislation is currently only available in its original format.

- (e) the performance of the aircraft; or
 - (ii) the period or periods during which the aircraft is actually flown in the circumstances specified in the said Parts;
- whichever is the greater.

Part I

Unpressurised aircraft

- (i) When flying at or below flight level 100:
Nil.
- (ii) When flying above flight level 100 but not exceeding flight level 120:

<i>Supply for</i>	<i>Duration</i>
(a) (a) Members of the flight crew	Any period during which the aircraft flies above flight level 100
(b) (b) Cabin attendants and 10% of passengers	For any continuous period exceeding 30 minutes during which the aircraft flies above flight level 100 but not exceeding flight level 120 the duration shall be the period by which 30 minutes is exceeded

- (iii) When flying above flight level 120:

<i>Supply for</i>	<i>Duration</i>
(a) (a) Members of the flight crew	Any period during which the aircraft flies above flight level 100
(b) (b) Cabin attendants and all passengers	Any period during which the aircraft flies above flight level 120

Part II

Pressurised aircraft

- (i) When flying at or below flight level 100:
Nil,
- (ii) When flying above flight level 100 but not exceeding flight level 250:

<i>Supply for</i>	<i>Duration</i>
(a) (a) Members of the flight crew	30 minutes or whenever the cabin pressure altitude exceeds 10,000 ft, whichever is the greater
(b) (b) Cabin attendants and 10% of passengers	(aa) When the aircraft is capable of descending and continuing to its destination as specified at A hereunder, 30 minutes or whenever the cabin pressure altitude exceeds 10,000 ft, whichever is the greater (bb) When the aircraft is not so capable, whenever the cabin pressure altitude

Status: This is the original version (as it was originally made). This item of legislation is currently only available in its original format.

<i>Supply for</i>	<i>Duration</i>
	is greater than 10,000 ft but does not exceed 12,000 ft
(c) (c) Cabin attendants and passengers	(aa) When the aircraft is capable of descending and continuing to its destination as specified at A hereunder, no requirement other than that at (ii)(b) (aa) of this Part of this Scale (bb) When the aircraft is not so capable and the cabin pressure altitude exceeds 12,000 ft, the duration shall be the period when the cabin pressure altitude exceeds 12,000 ft or 10 minutes, whichever is the greater
(iii) When flying above flight level 250:	
(a) (a) Members of the flight crew	2 hours or whenever the cabin pressure altitude exceeds 10,000 ft, whichever is the greater
(b) (b) Cabin attendants	Whenever the cabin pressure altitude exceeds 10,000 ft, and a portable supply for 15 minutes
(c) (c) 10% of passengers	Whenever the cabin pressure altitude exceeds 10,000 ft but does not exceed 12,000 ft
(d) (d) 30% of passengers	Whenever the cabin pressure altitude exceeds 12,000 ft but does not exceed 15,000 ft
(e) (e) All passengers	If the cabin pressure altitude exceeds 15,000 ft the duration shall be the period when the cabin pressure altitude exceeds 15,000 ft or 10 minutes, whichever is the greater
(f) (f) 2% of passengers or 2 passengers, whichever is the greater, being a supply of first aid oxygen which must be available for simultaneous first aid treatment of 2% or 2 passengers wherever they are seated in the aircraft	Whenever, after decompression, the cabin pressure altitude exceeds 8,000 ft

A The flying machine is capable, at the time when a failure to maintain cabin pressurisation occurs, of descending in accordance with the emergency descent procedure specified in the relevant flight manual and without flying below the minimum altitudes for safe flight specified in the operations manual relating to the aircraft, to flight level 120 within 5 minutes and of continuing at or below that flight level to its place of intended destination or any other place at which a safe landing can be made.

Scale M

Status: This is the original version (as it was originally made). This item of legislation is currently only available in its original format.

Equipment to prevent the impairment through ice formation of the functioning of the controls, means of propulsion, lifting surfaces, windows or equipment of the aircraft so as to endanger the safety of the aircraft.

Scale N

An intercommunication system for use by all members of the flight crew and including microphones, not of a hand-held type, for use by the pilot and flight engineer (if any).

Scale O

- (i) Subject to paragraph (ii), a radar set capable of giving warning to the pilot in command of the aircraft and to the co-pilot of the presence of cumulo-nimbus and other potentially hazardous weather conditions.
- (ii) A flight may commence if the set is unserviceable or continue if the set becomes unserviceable thereafter:
 - (a) so as to give the warning only to one pilot, so long as the aircraft is flying only to the place at which it first becomes reasonably practicable for the set to be repaired; or
 - (b) when the weather report or forecasts available to the commander of the aircraft indicate that cumulo-nimbus clouds or other hazardous weather conditions, which can be detected by the set when in working order, are unlikely to be encountered on the intended route or any planned diversion therefrom or the commander has satisfied himself that any such weather conditions will be encountered in daylight and can be seen and avoided, and the aircraft is in either case operated throughout the flight in accordance with any relevant instructions given in the operations manual.

Scale P

- (i) Subject to paragraphs (ii) and (v), a flight data recorder which is capable of recording, by reference to a time-scale, the following data:
 - (a) indicated airspeed;
 - (b) indicated altitude;
 - (c) vertical acceleration;
 - (d) magnetic heading;
 - (e) pitch attitude, if the equipment provided in the aeroplane is of such a nature as to enable this item to be recorded;
 - (f) engine power, if the equipment provided in the aeroplane is of such a nature as to enable this item to be recorded;
 - (g) flap position;
 - (h) roll attitude, if the equipment provided in the aeroplane is of such a nature as to enable this item to be recorded.
- (ii) Subject to paragraph (v), any aeroplane having a maximum total weight authorised not exceeding 11,400 kg may be provided with:
 - (a) a flight data recorder capable of recording the data described in paragraph (i)(a) to (i)(h); or
 - (b) a four channel cockpit voice recorder.
- (iii) Subject to paragraph (v), in addition, on all flights by turbine-powered aeroplanes having a maximum total weight authorised exceeding 11,400 kg, a 4 channel cockpit voice recorder.
- (iv) The night data recorder and cockpit voice recorder referred to above shall be so constructed that the record would be likely to be preserved in the event of an accident to the aeroplane.

- (v) An aeroplane shall not be required to carry the said equipment, if before take-off the equipment is found to be unserviceable and the aircraft flies in accordance with arrangements approved by the Governor.

Scale Q

If the maximum total weight authorised of the aeroplane exceeds 5,700 kg and it was first registered, whether in the Territory or elsewhere, on or after 1st June 1965, a door between the flight crew compartment and any adjacent compartment to which passengers have access, which door shall be fitted with a lock or bolt capable of being worked from the flight crew compartment.

Scale R

- (i)
 - (a) In respect of aeroplanes having a maximum total weight authorised exceeding 5,700 kg equipment sufficient to protect the eyes, nose and mouth of all members of the flight crew required to be carried by virtue of article 20 of this Order for a period of not less than 15 minutes and, in addition, where the minimum flight crew required as aforesaid is more than one and a cabin attendant is not required to be carried by virtue of article 20 of this Order, portable equipment sufficient to protect the eyes, nose and mouth of one member of the flight crew for a period of not less than 15 minutes.
 - (b) In respect of aeroplanes having a maximum total weight authorised not exceeding 5,700 kg, either the equipment specified in paragraph (i)(a) or, in the case of such aeroplanes restricted by virtue of the operator's operations manual to flight at or below flight level 250 and capable of descending as specified at A hereunder such equipment sufficient to protect the eyes only.
- (ii)
 - (a) In respect of aeroplanes having a maximum total weight authorised exceeding 5,700 kg, portable equipment to protect the eyes, nose and mouth of all cabin attendants required to be carried by virtue of article 20 of this Order for a period of not less than 15 minutes.
 - (b) In respect of aeroplanes having a maximum total weight authorised not exceeding 5,700 kg, subject to sub-paragraph (c), the equipment specified in paragraph (ii)(a).
 - (c) Sub-paragraph (b) shall not apply to such aeroplanes restricted by virtue of the operator's operations manual to flight at or below flight level 250 and capable of descending as specified at A hereunder.

A The aeroplane is capable of descending in accordance with the emergency descent procedure specified in the relevant flight manual and without flying below the minimum altitudes for safe flight specified in the operations manual relating to the aeroplane, to flight level 100 within 4 minutes and of continuing at or below that flight level to its place of intended destination or any other place at which a safe landing can be made.

Scale S

Subject to paragraph (vii), a flight recording system comprising:

- (i) either a 4 channel cockpit voice recorder or a flight data recorder capable of recording by reference to a time scale the data required to determine the following matters accurately in respect of the aeroplane: the flight plan, attitude and the basic lift, thrust and drag forces acting upon it;
- (ii) a 4 channel cockpit voice recorder and a flight data recorder capable of recording by reference to a time scale the data required to determine the following matters accurately in respect of the aeroplane: the information specified in paragraph (i) together with use of VHF transmitters;
- (iii) a 4 channel cockpit voice recorder and a flight data recorder capable of recording by reference to a time scale the data required to determine the following matters accurately in respect of the aeroplane: the flight path, attitude, the basic lift, thrust and drag forces acting upon it, the

Status: This is the original version (as it was originally made). This item of legislation is currently only available in its original format.

selection of high lift devices (if any) and airbrakes (if any), the position of primary flying control and pitch trim surfaces, outside air temperature, instrument landing deviations, use of automatic flight control systems, use of VHF transmitters, radio altitude (if any), the level or availability of essential AC electricity supply and cockpit warnings relating to engine fire and engine shut-down, cabin pressurisation, presence of smoke and hydraulic/pneumatic power supply;

- (iv) either a cockpit voice recorder and a flight data recorder or a combined cockpit voice recorder/flight data recorder capable in either case of recording by reference to a time scale the data required to determine the following matters accurately in respect of the aeroplane: the flight path, speed, attitude, engine power, outside air temperature, configuration of lift and drag devices, use of VHF transmitters and use of automatic flight control systems;
- (v) a cockpit voice recorder and a flight data recorder capable of recording by reference to a time scale the data required to determine the following matters accurately in respect of the aeroplane: the flight path, speed, attitude, engine power, outside air temperature, configuration of lift and drag devices, use of VHF transmitters and use of automatic flight control systems;
- (vi) a cockpit voice recorder and a flight data recorder capable of recording by reference to a time scale the data required to determine the following matters accurately in respect of the aeroplane: the flight path, speed, attitude, engine power, outside air temperature, instrument landing system deviations, marker beacon passage, radio altitude, configuration of the landing gear and lift and drag devices, position of primary flying controls, pitch trim position, use of automatic flight control systems, use of VHF transmitters, ground speed/drift angle or latitude/longitude if the navigational equipment provided in the aeroplane is of such a nature as to enable this information to be recorded with reasonable practicability, cockpit warnings relating to ground proximity and the master warning system;
- (vii) an aircraft shall not be required to carry the said equipment if before take-off the equipment is found to be unserviceable and the aircraft flies in accordance with arrangements approved by the Governor.

The cockpit voice recorder or flight data recorder or combined cockpit voice recorder/flight data recorder, as the case may be, shall be so constructed that the record would be likely to be preserved in the event of an accident.

Scale SS

- (i) Subject to paragraph (iv), a four channel cockpit voice recorder capable of recording and retaining the data recorded during at least the last 30 minutes of its operation and a flight data recorder capable of recording and retaining the data recorded during at least the last eight hours of its operation being the data required to determine by reference to a time scale the following matters accurately in respect of the helicopter or gyroplane:
 - (a) flight path;
 - (b) speed;
 - (c) attitude;
 - (d) engine power;
 - (e) main rotor speed;
 - (f) outside air temperature;
 - (g) position of pilot's primary flight controls;
 - (h) use of VHF transmitters;
 - (j) use of automatic flight controls (if any);
 - (k) use of stability augmentation system (if any);

- (l) cockpit warnings relating to the master warning system; and
 - (m) selection of hydraulic system and cockpit warnings of failure of essential hydraulic systems.
- (ii) Subject to paragraph (iv), a 4 channel cockpit voice recorder capable of recording and retaining the data recorded during at least the last 30 minutes of its operation and a flight data recorder capable of recording and retaining the data recorded during at least the last 8 hours of its operation being the data required to determine by reference to a time scale the information specified in paragraph (i) together with the following matters accurately in respect of the helicopter or gyroplane:
- (n) landing gear configuration;
 - (p) indicated sling load force if an indicator is provided in the helicopter or gyroplane of such a nature as to enable this information to be recorded with reasonable practicability;
 - (q) radio altitude;
 - (r) instrument landing system deviations;
 - (s) marker beacon passage;
 - (t) ground speed/drift angle or latitude/longitude if the navigational equipment provided in the helicopter or gyroplane is of such a nature as to enable this information to be recorded with reasonable practicability; and
 - (u) main gear box oil temperature and pressure.
- (iii) Subject to paragraph (iv):
- (a) A combined, cockpit voice recorder/flight data recorder which meets the following requirements:
 - (aa) in the case of a helicopter or gyroplane which is otherwise required to carry a flight data recorder specified at paragraph (i) the flight data recorder shall be capable of recording the data specified therein and retaining it for the duration therein specified;
 - (bb) in the case of a helicopter or gyroplane which is otherwise required to carry a flight data recorder specified at paragraph (ii), the flight data recorder shall be capable of recording the data specified therein and retaining it for the duration therein specified;
 - (cc) the cockpit voice recorder shall be capable of recording and retaining at least the last hour of cockpit voice recording information on not less than three separate channels.
 - (b) (aa) In any case when a combined cockpit voice recorder/flight data recorder specified at paragraph (iii)(a) is required to be carried by or under this Order, the flight data recorder shall be capable, subject to sub-paragraph (bb), of retaining as protected data the data recorded during at least the last 5 hours of its operation or the maximum duration of the flight, whichever is the greater. It shall also be capable of retaining additional data as unprotected data for a period which together with the period for which protected data is required to be retained amounts to a total of 8 hours.
 - (bb) The flight data recorder need not be capable of retaining the said additional data if additional data is retained which relates to the period immediately preceding the period to which the required protected data relates or for such other period or periods as the Governor may permit pursuant to article 53 of this Order and the additional data is retained in accordance with arrangements approved by the Governor.

Status: This is the original version (as it was originally made). This item of legislation is currently only available in its original format.

- (iv) A helicopter or gyroplane shall not be required to carry the said equipment if, before take-off, the equipment is found to be unserviceable and the aircraft flies in accordance with arrangements approved by the Governor.

With the exception of flight data which it is expressly stated above may be unprotected, the cockpit voice recorder, flight data recorder or combined cockpit voice recorder and flight data recorder, as the case may be, shall be so constructed and installed that the record (herein referred to as “protected data”) would be likely to be preserved in the event of an accident and each cockpit voice recorder, flight data recorder or combined cockpit voice recorder/flight data recorder required to be carried on the helicopter or gyroplane shall have attached an automatically activated underwater sonar location device or an emergency locator radio transmitter.

Scale T

An underwater sonar location device except in respect of those helicopters or gyroplanes which are required to carry equipment in accordance with Scale SS.

Scale U

- (i) 1 survival beacon radio apparatus;
- (ii) marine type pyrotechnical distress signals;
- (iii) for each 4 or proportion of 4 persons on board, 100 grammes of glucose toffee tablets;
- (iv) for each 4 or proportion of 4 persons on board, ½ litre of fresh water in durable containers;
- (v) first aid equipment.

Scale V

- (i) 1 survival beacon radio apparatus;
- (ii) marine type pyrotechnical distress signals;
- (iii) for each 4 or proportion of 4 persons on board, 100 grammes of glucose toffee tablets;
- (iv) for each 4 or proportion of 4 persons on board, ½ litre of fresh water in durable containers;
- (v) first aid equipment;
- (vi) for every 75 or proportion of 75 persons on board, 1 stove suitable for use with aircraft fuel;
- (vii) 1 cooking utensil, in which snow or ice can be melted;
- (viii) 2 snow shovels;
- (ix) 2 ice saws;
- (x) single or multiple sleeping bags, sufficient for the use of one-third of all persons on board;
- (xi) 1 Arctic suit for each member of the crew of the aircraft.

Scale W

- (i) Subject to paragraph (ii), cosmic radiation detection equipment calibrated in millirems per hours and capable of indicating the action and alert levels of radiation dose rate.
- (ii) An aircraft shall not be required to carry the said equipment if before take-off the equipment is found to be unserviceable and it is not reasonably practicable to repair or replace it at the aerodrome of departure and the radiation forecast available to the commander of the aircraft indicates that hazardous radiation conditions are unlikely to be encountered by the aircraft on its intended route or any planned diversion therefrom.

Scale X

- (i) Subject to paragraph (iii), a Ground Proximity Warning System being equipment capable of giving warning to the pilot of the potentially hazardous proximity of ground or water.
- (ii) Subject to paragraph (iii), a Terrain Awareness and Warning System being equipment capable of giving warning to the pilot of the potentially hazardous proximity of ground or water, including a predictive terrain hazard warning function.
- (iii) If the equipment becomes unserviceable, the aircraft may fly or continue to fly until it first lands at a place at which it is reasonably practicable for the equipment to be repaired or replaced.

Scale Y

- (i) If the aircraft may in accordance with its certificate of airworthiness carry more than 19 and less than 100 passengers, one portable battery-powered megaphone capable of conveying instructions to all persons in the passenger compartment and readily available for use by a member of the crew.
- (ii) If the aircraft may in accordance with its certificate of airworthiness carry more than 99 and less than 200 passengers, 2 portable battery-powered megaphones together capable of conveying instructions to all persons in the passenger compartment and each readily available for use by a member of the crew.
- (iii) If the aircraft may in accordance with its certificate of airworthiness carry more than 199 passengers, 3 portable battery-powered megaphones together capable of conveying instructions to all persons in the passenger compartment and each readily available for use by a member of the crew.
- (iv) If the aircraft may in accordance with its certificate of airworthiness carry more than 19 passengers:
 - (a) a public address system; and
 - (b) an interphone system of communication between members of the flight crew and the cabin attendants.

Scale Z

- (i) An emergency lighting system to provide illumination in the passenger compartment sufficient to facilitate the evacuation of the aircraft notwithstanding the failure of the lighting systems specified in paragraph (ii) of Scale G.
- (ii) An emergency lighting system to provide illumination outside the aircraft sufficient to facilitate the evacuation of the aircraft.
- (iii)
 - (a) Subject to sub-paragraph (b), an emergency floor path lighting system in the passenger compartment sufficient to facilitate the evacuation of the aircraft notwithstanding the failure of the lighting systems specified in paragraph (ii) of Scale G.
 - (b) If the equipment specified in sub-paragraph (a) becomes unserviceable the aircraft may fly or continue to fly in accordance with arrangements approved by the Governor.

SCHEDULE 5

Articles 15 and 52

Radio and radio navigation equipment to be carried in aircraft

1. Every aircraft shall be provided, when flying in the circumstances specified in the first column of the Table set forth in paragraph 2 of this Schedule, with the scales of equipment respectively indicated in that Table save that if the aircraft is flying in a combination of such circumstances the scales of equipment shall not on that account be required to be duplicated.

Status: This is the original version (as it was originally made). This item of legislation is currently only available in its original format.

2. Table

<i>Aircraft and circumstances of flight</i>	A	B	C	D	E	F	G	H	J
1. All aircraft (other than gliders) within the Territory:									
when flying under Instrument Flight Rules within controlled airspace					E*	F**			
when flying within controlled airspace									
when making an approach to landing at an aerodrome notified for the purpose of this sub-paragraph							G*		
* Unless the appropriate air traffic control unit otherwise permits in relation to the particular flight and provided that the aircraft complies with any instructions which the air traffic control unit may give in the particular case.									
# Provided that non-public transport aircraft flying in Class D and E airspace shall not be required to be provided with distance measuring equipment.									

Status: This is the original version (as it was originally made). This item of legislation is currently only available in its original format.

<i>Aircraft Scale of equipment required and circumstances of flight</i>	A	B	C	D	E	F	G	H	J
(2)All aircraft within the Territory: <div style="margin-left: 2em;"> when[*] (a) flying at or above flight level 245 when[*] (b) flying within airspace notified for the purposes of this sub-paragraph </div>									
(3)All aircraft (other than gliders) within the Territory: <div style="margin-left: 2em;"> when[*] (a) flying at or above flight </div>					E [*]	F [*]			

* Unless the appropriate air traffic control unit otherwise permits in relation to the particular flight and provided that the aircraft complies with any instructions which the air traffic control unit may give in the particular case.

Provided that non-public transport aircraft flying in Class D and E airspace shall not be required to be provided with distance measuring equipment.

Status: This is the original version (as it was originally made). This item of legislation is currently only available in its original format.

<i>Aircraft and circumstances of flight</i>	A	B	C	D	E	F	G	H	J
level 245									
when (b) flying within airspace notified for the purpose of this sub-paragraph					E*				
when (c) flying at or above flight level 100					E*				
(4)All aircraft registered in the Territory, wherever they may be:	A		C	D				H	
(a) when flying for the purpose of public transport under Instrument									

* Unless the appropriate air traffic control unit otherwise permits in relation to the particular flight and provided that the aircraft complies with any instructions which the air traffic control unit may give in the particular case.

Provided that non-public transport aircraft flying in Class D and E airspace shall not be required to be provided with distance measuring equipment.

Status: This is the original version (as it was originally made). This item of legislation is currently only available in its original format.

<i>Aircraft and circumstances of flight</i>	A	B	C	D	E	F	G	H	J
Flight Rules:									
(i) while making an approach to landing									
(ii) on all other occasions	A		C					H	
subject to sub-paragraph (d), multi-engined aircraft when flying for the purpose of public transport under Visual Flight Rules	A (b)							H	
subject to sub-paragraph (d), single-engined aircraft when flying for	A (c)								
<p>* Unless the appropriate air traffic control unit otherwise permits in relation to the particular flight and provided that the aircraft complies with any instructions which the air traffic control unit may give in the particular case.</p> <p># Provided that non-public transport aircraft flying in Class D and E airspace shall not be required to be provided with distance measuring equipment.</p>									

Status: This is the original version (as it was originally made). This item of legislation is currently only available in its original format.

<i>Aircraft and circumstances of flight</i>	A	B	C	D	E	F	G	H	J
<p>the purpose of public transport under Visual Flight Rules:</p> <p style="padding-left: 40px;">(i) over a route on which navigation is effected solely by visual reference to landmarks</p> <p>(ii) on all other occasions</p> <p>(iii) when flying under Instrument Flight Rules within controlled airspace and not required to comply</p>									

* Unless the appropriate air traffic control unit otherwise permits in relation to the particular flight and provided that the aircraft complies with any instructions which the air traffic control unit may give in the particular case.

Provided that non-public transport aircraft flying in Class D and E airspace shall not be required to be provided with distance measuring equipment.

Status: This is the original version (as it was originally made). This item of legislation is currently only available in its original format.

<i>Aircraft Scale of equipment required and circumstances of flight</i>	A	B	C	D	E	F	G	H	J
with (4)paragraph (a) above									
(5)om 1st January 2003, all aeroplanes registered in the Territory, wherever they may be, and all aeroplanes wherever registered when flying in the Territory, powered by one or more turbine jets or turbine propeller engines and either having a maximum take-off weight exceeding 15 000 kg or which									J
* Unless the appropriate air traffic control unit otherwise permits in relation to the particular flight and provided that the aircraft complies with any instructions which the air traffic control unit may give in the particular case.									
# Provided that non-public transport aircraft flying in Class D and E airspace shall not be required to be provided with distance measuring equipment.									

Status: This is the original version (as it was originally made). This item of legislation is currently only available in its original format.

<i>Aircraft and circumstances of flight</i>	A	B	C	D	E	F	G	H	J
<p>in accordance with the certificate of airworthiness in force in respect thereof may carry more than 30 passengers</p>									
<p>* Unless the appropriate air traffic control unit otherwise permits in relation to the particular flight and provided that the aircraft complies with any instructions which the air traffic control unit may give in the particular case.</p> <p># Provided that non-public transport aircraft flying in Class D and E airspace shall not be required to be provided with distance measuring equipment.</p>									

3. The scales of radio and radio navigation equipment indicated in the foregoing Table shall be as follows:

Scale A

Radio equipment capable of maintaining direct two-way communication with the appropriate aeronautical radio stations.

Scale B

Radio navigation equipment capable of enabling the aircraft to be navigated on the intended route including such equipment as may be prescribed.

Scale C

Radio equipment capable of receiving from the appropriate aeronautical radio stations meteorological broadcasts relevant to the intended flight.

Scale D

Radio navigation equipment capable of receiving signals from one or more aeronautical radio stations on the surface to enable the aircraft to be guided to a point from which a visual landing can be made at the aerodrome at which the aircraft is to land.

Scale E

Secondary surveillance radar equipment.

Scale F

Radio and radio navigation equipment capable of enabling the aircraft to be navigated along the intended route including:

- (i) automatic direction finding equipment;
- (ii) distance measuring equipment; and
- (iii) VHF omni-range equipment.

Scale G

Radio navigation equipment capable of enabling the aircraft to make an approach to landing using the Instrument Landing System.

Scale H

- (i) Subject to paragraph (ii), radio navigation equipment capable of enabling the aircraft to be navigated on the intended route including:
 - (a) automatic direction finding equipment;
 - (b) distance measuring equipment;
 - (c) duplicated VHF omni-range equipment; and
 - (d) a 75 MHz marker beacon receiver.
- (ii)
 - (a) An aircraft may fly notwithstanding that it does not carry the equipment specified in this Scale if it carries alternative radio navigation equipment or navigational equipment approved by the Governor in writing in accordance with the provisions of article 14(7) of this Order.
 - (b) Where not more than one item of equipment specified in this Scale is unserviceable when the aircraft is about to begin a flight, the aircraft may nevertheless take off on that flight if:
 - (aa) it is not reasonably practicable for the repair or replacement of that item to be carried out before the beginning of the flight;
 - (bb) the aircraft has not made more than one flight since the item was last serviceable; and
 - (cc) the commander of the aircraft has satisfied himself that, taking into account the latest information available as to the route and aerodrome to be used (including any planned diversion) and the weather conditions likely to be encountered, the flight can be made safely and in accordance with any relevant requirements of the appropriate air traffic control unit.

Scale J

An airborne collision avoidance system.

4. In this Schedule:

(1) “Automatic direction finding equipment” means radio navigation equipment which automatically indicates the bearing of any radio station transmitting the signals received by such equipment;

(2) “VHF omni-range equipment” means radio navigation equipment capable of giving visual indications of bearings of the aircraft by means of signals received from very high frequency omni-directional radio ranges;

(3) “Distance measuring equipment” means radio equipment capable of providing a continuous indication of the aircraft’s distance from the appropriate aeronautical radio stations;

(4) “Secondary surveillance radar equipment” means such type of radio equipment as may be notified as being capable of (a) replying to an interrogation from secondary surveillance radar units

Status: This is the original version (as it was originally made). This item of legislation is currently only available in its original format.

on the surface and (b) being operated in accordance with such instructions as may be given to the aircraft by the appropriate air traffic control unit;

(5) “Airborne collision avoidance system” means an aeroplane system which conforms to requirements prescribed for the purpose in regulation 20 in Schedule 14 to this Order; is based on secondary surveillance radar transponder signals; operates independently of ground based equipment and which is designed to provide advice and appropriate avoidance manoeuvres to the pilot in relation to other aeroplanes which are equipped with secondary surveillance radar and are in undue proximity.

SCHEDULE 6

Article 17

Aircraft, engine and propeller log books

1 Aircraft log book

1. The following entries shall be included in the aircraft log book:
 - (a) the name of the constructor, the type of the aircraft, the number assigned to it by the constructor and the date of the construction of the aircraft;
 - (b) the nationality and registration marks of the aircraft;
 - (c) the name and address of the operator of the aircraft;
 - (d) the date of each flight and the duration of the period between take-off and landing, or, if more than one flight was made on that day, the number of flights and the total duration of the periods between take-offs and landings on that day;
 - (e) subject to sub-paragraph (h), particulars of all maintenance work carried out on the aircraft or its equipment;
 - (f) subject to sub-paragraph (h), particulars of any defects occurring in the aircraft or in any equipment required to be carried therein by or under this Order, and of the action taken to rectify such defects including a reference to the relevant entries in the technical log required by article 11(2) and (3) of this Order;
 - (g) subject to sub-paragraph (h), particulars of any overhauls, repairs, replacements and modifications relating to the aircraft or any such equipment as aforesaid;
 - (h) entries shall not be required to be made under sub-paragraphs (e), (f) and (g) in respect of any engine or variable pitch propeller.

2 Engine log book

2. The following entries shall be included in the engine log book:
 - (a) the name of the constructor, the type of the engine, the number assigned to it by the constructor and the date of the construction of the engine;
 - (b) the nationality and registration marks of each aircraft in which the engine is fitted;
 - (c) the name and address of the operator of each such aircraft;
 - (d) either:
 - (i) the date of each flight and the duration of the period between take-off and landing or, if more than one flight was made on that day, the number of flights and the total duration of the periods between take-offs and landings on that day; or

- (ii) the aggregate duration of periods between take-off and landings for all flights made by that aircraft since the immediately preceding occasion that any maintenance, overhaul, repair, replacement, modification or inspection was undertaken on the engine;
- (e) particulars of all maintenance work done on the engine;
- (f) particulars of any defects occurring in the engine, and of the rectification of such defects, including a reference to the relevant entries in the technical log required by article 11(2) and (3) of this Order;
- (g) particulars of all overhauls, repairs, replacements and modifications relating to the engine or any of its accessories.

3 Variable pitch propeller log book

3. The following entries shall be included in the variable pitch propeller log book:
- (a) the name of the constructor, the type of propeller, the number assigned to it by the constructor and the date of the construction of the propeller;
 - (b) the nationality and registration marks of each aircraft, and the type and number of each engine, to which the propeller is fitted;
 - (c) the name and address of the operator of such aircraft;
 - (d) either:
 - (i) the date of each flight and the duration of the period between take-off and landing or, if more than one flight was made on that day, the number of flights and the total duration of the periods between take-offs and landings on that day; or
 - (ii) the aggregate duration of periods between take-off and landing for all flights made by that aircraft since the immediately preceding occasion that any maintenance, overhaul, repair, replacement, modification or inspection was undertaken on the propeller;
 - (e) particulars of all maintenance work done on the propeller;
 - (f) particulars of any defects occurring in the propeller, and of the rectification of such defects, including a reference to the relevant entries in the technical log required by article 11(2) and (3) of this Order;
 - (g) particulars of any overhauls, repairs, replacements and modifications relating to the propeller.

SCHEDULE 7

Article 20(4)

Areas specified in connection with the carriage of flight navigators as members of the flight crews or suitable navigational equipment on public transport aircraft

The following areas are hereby specified for the purposes of article 20(4) of this Order:

Area A-Arctic

All that area north of latitude 68° north, but excluding any part thereof within the area enclosed by rhumb lines joining successively the following points:

68° north latitude 00° east/west longitude

73° north latitude 15° east longitude

Status: This is the original version (as it was originally made). This item of legislation is currently only available in its original format.

73° north latitude 30° east longitude
68° north latitude 45° east longitude
68° north latitude 00° east/west longitude

Area B-Antarctic

All that area south of latitude 55° south.

Area C-Sahara

All that area enclosed by rhumb lines joining successively the following points:

30° north latitude 05° west longitude
24° north latitude 11° west longitude
14° north latitude 11° west longitude
14° north latitude 28° east longitude
24° north latitude 28° east longitude
28° north latitude 23° east longitude
30° north latitude 15° east longitude
30° north latitude 05° west longitude

Area D-South America

All that area enclosed by rhumb lines joining successively the following points:

04° north latitude 72° west longitude
04° north latitude 60° west longitude
08° south latitude 42° west longitude
18° south latitude 54° west longitude
18° south latitude 60° west longitude
14° south latitude 72° west longitude
05° south latitude 76° west longitude
04° north latitude 72° west longitude

Area E-Pacific Ocean

All that area enclosed by rhumb lines joining successively the following points:

60° north latitude 180° east/west longitude
20° north latitude 128° east longitude
04° north latitude 128° east longitude
04° north latitude 180° east/west longitude
55° south latitude 180° east/west longitude
55° south latitude 82° west longitude
25° south latitude 82° west longitude
60° north latitude 155° west longitude
60° north latitude 180° east/west longitude

Area F-Australia

All that area enclosed by rhumb lines joining successively the following points:

- 18° south latitude 123° east longitude
- 30° south latitude 118° east longitude
- 30° south latitude 135° east longitude
- 18° south latitude 123° east longitude

Area G-Indian Ocean

All that area enclosed by rhumb lines joining successively the following points:

- 35° south latitude 110° east longitude
- 55° south latitude 180° east/west longitude
- 55° south latitude 10° east longitude
- 40° south latitude 10° east longitude
- 25° south latitude 60° east longitude
- 20° south latitude 60° east longitude
- 05° south latitude 43° east longitude
- 10° north latitude 55° east longitude
- 10° north latitude 73° east longitude
- 04° north latitude 77° east longitude
- 04° north latitude 92° east longitude
- 10° south latitude 100° east longitude
- 10° south latitude 110° east longitude
- 35 south latitude 110 east longitude

Area H—North Atlantic Ocean

All that area enclosed by rhumb lines joining successively the following points:

- 55° north latitude 15° west longitude
- 68° north latitude 28° west longitude
- 68° north latitude 60° west longitude
- 45° north latitude 45° west longitude
- 40° north latitude 60° west longitude
- 40° north latitude 19° west longitude
- 55° north latitude 15° west longitude

Area I—South Atlantic Ocean

All that area enclosed by rhumb lines joining successively the following points:

- 40° north latitude 60° west longitude
- 18° north latitude 60° west longitude
- 05° south latitude 30° west longitude
- 55° south latitude 55° west longitude

Status: This is the original version (as it was originally made). This item of legislation is currently only available in its original format.

55° south latitude 10° east longitude
40° south latitude 10° east longitude
02° north latitude 05° east longitude
02° north latitude 10° west longitude
15° north latitude 25° west longitude
40° north latitude 19° west longitude
40° north latitude 60° west longitude

Area J—Northern Canada

All that area enclosed by rhumb lines joining successively the following points:

68° north latitude 130° west longitude
55° north latitude 115° west longitude
55° north latitude 70° west longitude
68° north latitude 60° west longitude
68° north latitude 130° west longitude

Area K—Northern Asia

All that area enclosed by rhumb lines joining successively the following points:

68° north latitude 56° east longitude
68° north latitude 160° east longitude
50° north latitude 125° east longitude
50° north latitude 56° east longitude
68° north latitude 56° east longitude

Area L—Southern Asia

All that area enclosed by rhumb lines joining successively the following points:

50° north latitude 56° east longitude
50° north latitude 125° east longitude
40° north latitude 110° east longitude
30° north latitude 110° east longitude
30° north latitude 80° east longitude
35° north latitude 80° east longitude
35° north latitude 56° east longitude
50° north latitude 56° east longitude

SCHEDULE 8

Articles 22, 23, 24, and 26

PART A— LICENCES

MINIMUM AGE, PERIOD OF VALIDITY, PRIVILEGES

1. AEROPLANE PILOTS

Private Pilot's Licence (Aeroplanes)

Minimum age—17 years

No maximum period of validity

Privileges:

(1) Subject to paragraph (2), the holder of the licence shall be entitled to fly as pilot in command or co-pilot of an aeroplane of any of the types specified or otherwise falling within an aircraft rating included in the licence.

(a) (2) (a) He shall not fly such an aeroplane for the purpose of public transport or aerial work save as hereinafter provided:

(i) he may fly such an aeroplane for the purpose of aerial work which consists of:

(aa) the giving of instruction in flying, if his licence includes a flying instructor's rating or an assistant flying instructor's rating; or

(bb) the conducting of flying tests for the purposes of this Order;

in either case in an aeroplane owned, or operated under arrangements entered into, by a flying club of which the person giving the instruction or conducting the test and the person receiving the instruction or undergoing the test are both members;

(ii) he may fly such an aeroplane for the purpose of aerial work which consists of:

(aa) towing a glider in flight; or

(bb) a flight for the purpose of dropping of persons by parachute;

in either case in an aeroplane owned, or operated under arrangements entered into, by a club of which the holder of the licence and any person carried in the aircraft or in any glider towed by the aircraft are members.

(b) He shall not receive any remuneration for his services as a pilot on a flight save that if his licence includes a flying instructor's rating or an assistant flying instructor's rating by virtue of which he is entitled to give instruction in flying microlight aircraft or self-launching motor gliders he may receive remuneration for the giving of such instruction or the conducting of such flying tests as are specified in sub-paragraph (a)(i) in a microlight aircraft or a self-launching motor glider.

(c) He shall not, unless his licence includes an instrument rating (aeroplanes) or an instrument meteorological conditions rating (aeroplanes), fly as pilot in command of such an aeroplane:

(i) on a flight outside controlled airspace when the flight visibility is less than 3 km;

(ii) on a special VFR flight in a control zone in a flight visibility of less than 10 km except on a route or in an aerodrome traffic zone notified for the purpose of this sub-paragraph; or

(iii) out of sight of the surface.

Status: This is the original version (as it was originally made). This item of legislation is currently only available in its original format.

- (d) He shall not fly as pilot in command of such an aeroplane at night unless his licence includes a night rating (aeroplanes).
- (e) He shall not, unless his licence includes an instrument rating (aeroplanes), fly as pilot in command or co-pilot of such an aeroplane flying in Class A, B or C airspace in circumstances which require compliance with the Instrument Flight Rules.
- (f) He shall not, unless his licence includes an instrument rating (aeroplanes) or an instrument meteorological conditions rating (aeroplanes), fly as pilot in command or co-pilot of such an aeroplane flying in Class D or E airspace in circumstances which require compliance with the Instrument Flight Rules.
- (g) He shall not fly as pilot in command of such an aeroplane carrying passengers unless within the preceding 90 days he has made three take-offs and three landings as the sole manipulator of the controls of an aeroplane of the same type and if such a flight is to be carried out at night and his licence does not include an instrument rating (aeroplane) at least one of those take-offs and landings shall have been at night.

Basic Commercial Pilot's Licence (Aeroplanes)

Minimum age—18 years

Maximum period of validity—10 years

Privileges:

- (1) The holder of the licence shall be entitled to exercise the privileges of a Private Pilot's Licence (Aeroplanes).
 - (a) (2) (a) Subject to sub-paragraph (b), he shall be entitled to fly as pilot in command of an aeroplane of a type on which he is so qualified and which is specified in an aircraft rating included in the licence when the aeroplane is engaged on a flight for any purpose whatsoever.
 - (b) (i) He shall not fly such an aeroplane on a flight for the purpose of public transport if he has less than 400 hours of flying experience in command of aeroplanes other than self-launching motor gliders or microlight aircraft.
 - (ii) He shall not fly such an aeroplane on a flight for the purpose of public transport if its maximum total weight authorised exceeds 2,300 kg.
 - (iii) He shall not fly such an aeroplane on any scheduled journey.
 - (iv) He shall not fly such an aeroplane on a flight for the purpose of public transport except a flight beginning and ending at the same aerodrome and not extending beyond 25 nautical miles from that aerodrome.
 - (v) He shall not fly such an aeroplane on a flight for the purpose of public transport after he attains the age of 60 years unless the aeroplane is fitted with dual controls and carries a second pilot who has not attained the age of 60 years and who holds an appropriate licence under this Order entitling him to act as pilot in command or co-pilot of that aeroplane.
 - (vi) He shall not fly such an aeroplane at night, unless his licence includes a night rating (aeroplanes).
 - (vii) He shall not, unless his licence includes an instrument rating (aeroplanes) or an instrument meteorological conditions rating (aeroplanes), fly as pilot in command of such an aeroplane:
 - (aa) on a flight outside controlled airspace when the flight visibility is less than 3 km;

- (bb) on a special VFR flight in a control zone in a flight visibility of less than 10 km except on a route or in an aerodrome traffic zone notified for the purposes of this sub-paragraph; or
- (cc) out of sight of the surface.
- (viii) He shall not, unless his licence includes an instrument rating (aeroplanes), fly as pilot in command or co-pilot of such an aeroplane flying in Class A, B or C airspace in circumstances which require compliance with the Instrument Flight Rules.
- (ix) He shall not, unless his licence includes an instrument rating (aeroplanes) or an instrument meteorological conditions rating (aeroplanes), fly as pilot in command or co-pilot of such an aeroplane flying in Class D or E airspace in circumstances which require compliance with the Instrument Flight Rules.
- (x) He shall not fly as pilot in command of such an aeroplane carrying passengers unless within the preceding 90 days he has made three take-offs and three landings as the sole manipulator of the controls of an aeroplane of the same type and if the flight is to be undertaken at night and his licence does not include an instrument rating (aeroplanes) at least one of those take-offs and landings shall have been at night.
- (a) (3) (a) Subject to sub-paragraph (b), he shall be entitled to fly as pilot in command of an aeroplane of a type specified in a flying instructor's rating or an assistant flying instructor's rating included in the licence on a flight for the purpose of aerial work which consists of:
 - (i) the giving of instruction in flying; or
 - (ii) the conducting of flying tests for the purposes of this Order;

in either case in an aeroplane owned, or operated under arrangements entered into, by a flying club of which the person giving the instruction or conducting the test and the person receiving the instruction or undergoing the test are both members.

- (b) He shall not be entitled to exercise the privileges contained in this paragraph other than in an aeroplane which he is entitled to fly as pilot in command on a private flight, an aerial work flight or a public transport flight pursuant to the privileges set out in paragraph (1) or (2) of these privileges.
- (a) (4) (a) Subject to paragraph (b), he shall be entitled to fly as co-pilot of any aeroplane of type specified in an aircraft rating included in the licence when the aeroplane is engaged on a flight for any purpose whatsoever.
- (b) He shall not be entitled to fly as co-pilot of an aeroplane which is engaged on a flight for the purpose of public transport unless he has more than 400 hours of flying experience as pilot in command of aeroplanes other than self-launching motor gliders and microlight aircraft and the aeroplane is certified for single pilot operation.
- (5) He shall not at any time after he attains the age of 65 years act as pilot in command or co-pilot of any aeroplane on a flight for the purpose of public transport.

Commercial Pilot's Licence (Aeroplanes)

Minimum age—18 years

Maximum period of validity—10 years

Privileges:

- (1) The holder of the licence shall be entitled to exercise the privileges of a Private Pilot's Licence (Aeroplanes) which includes an instrument meteorological conditions rating (aeroplanes) and a night rating (aeroplanes), and, shall be entitled to fly as pilot in command of an aeroplane:
 - (a) on a special VFR flight notwithstanding that the flight visibility is less than 3 km;

Status: This is the original version (as it was originally made). This item of legislation is currently only available in its original format.

- (b) when the aeroplane is taking off or landing at any place notwithstanding that the flight visibility below cloud is less than 1,800 metres.
- (a) (2) (a) Subject to sub-paragraph (b), he shall be entitled to fly as pilot in command of an aeroplane of a type specified in Part 1 of the aircraft rating included in the licence when the aeroplane is engaged on a flight for any purpose whatsoever.
- (b) (i) He shall not, unless his licence includes an instrument rating (aeroplanes), fly such an aeroplane on any scheduled journey.
- (ii) He shall not:
 - (aa) fly as pilot in command of an aeroplane carrying passengers unless he has carried out at least three take-offs and three landings as pilot flying in an aeroplane of the same type or in a flight simulator approved, for the purpose, of the aeroplane type to be used, in the preceding 90 days;
 - (bb) as co-pilot serve at the flying controls in an aeroplane carrying passengers during take-off and landing unless he has served as a pilot at the controls during take-off and landing in an aeroplane of the same type or in a flight simulator, approved for the purpose, of the aeroplane type to be used, in the preceding 90 days; or
 - (cc) as the holder of a licence which does not include a valid instrument rating (aeroplanes) act as pilot in command of an aeroplane carrying passengers at night unless during the previous 90 days at least one of the take-offs and landings required in sub-paragraph (aa) above has been carried out at night.
- (iii) He shall not, unless his licence includes an instrument rating (aeroplanes), fly any such aeroplane of which the maximum total weight authorised exceeds 2,300 kg on any flight for the purpose of public transport, except a flight beginning and ending at the same aerodrome and not extending beyond 25 nautical miles from that aerodrome.
- (iv) He shall not fly such an aeroplane on a flight for the purpose of public transport unless it is certificated for single pilot operation.
- (v) He shall not fly such an aeroplane on any flight for the purpose of public transport after he attains the age of 60 years unless the aeroplane is fitted with dual controls and carries a second pilot who has not attained the age of 60 years and who holds an appropriate licence under this Order entitling him to act as pilot in command or co-pilot of that aeroplane.
- (vi) He shall not, unless his licence includes an instrument rating (aeroplanes), fly as pilot in command or co-pilot of such an aeroplane flying in Class A, B or C airspace in circumstances which require compliance with the Instrument Flight Rules.
- (a) (3) (a) Subject to sub-paragraph (b), he shall be entitled to fly as pilot in command of an aeroplane of a type specified in a flying instructor's rating or an assistant flying instructor's rating included in the licence on a flight for the purpose of aerial work which consists of:
 - (i) the giving of instruction in flying; or
 - (ii) the conducting of flying tests for the purposes of this Order;

in either case in an aeroplane owned, or operated under arrangements entered into, by a flying club of which the person giving the instruction or conducting the test and the person receiving the instruction or undergoing the test are both members.

- (b) He shall not be entitled to exercise privileges contained in this paragraph other than in an aeroplane which he is entitled to fly as pilot in command on a private flight, an aerial work flight or a public transport flight pursuant to the privileges set out in paragraph (1) or (2) of these privileges.

(4) He shall be entitled to fly as co-pilot of any aeroplane of a type specified in an aircraft rating included in the licence when the aeroplane is engaged on a flight for any purpose whatsoever.

(5) He shall not at any time after he attains the age of 65 years act as pilot in command or co-pilot of any aeroplane on a flight for the purpose of public transport.

Airline Transport Pilot's Licence (Aeroplanes)

Minimum age—21 years

Maximum period of validity—10 years

Privileges:

The holder of the licence shall be entitled to exercise the privileges of a Commercial Pilot's Licence (Aeroplanes) except that sub-paragraph (2)(b)(iv) of those privileges shall not apply.

2. HELICOPTER AND GYROPLANE PILOTS

Private Pilot's Licence (Helicopters)

Minimum age—17 years

No maximum period of validity

Privileges:

(1) Subject to paragraph (2), the holder of the licence shall be entitled to fly as pilot in command or co-pilot of any helicopter of a type specified in an aircraft rating included in the licence.

(a) (2) (a) He shall not fly such a helicopter for the purpose of public transport or aerial work other than aerial work which consists of:

(i) the giving of instruction in flying if his licence includes a flying instructor's rating or an assistant flying instructor's rating; or

(ii) the conducting of flying tests for the purposes of this Order;

in either case in a helicopter owned, or operated under arrangements entered into, by a flying club of which the person giving the instruction or conducting the test and the person receiving the instruction or undergoing the test are both members.

(b) He shall not receive any remuneration for his services as a pilot on a flight other than remuneration for the giving of such instruction or the conducting of such flying tests as are specified in sub-paragraph (a).

(c) He shall not fly as pilot in command of such a helicopter at night unless:

(i) prior to 1st September 2001, his licence includes a night rating (helicopters) and either also includes an instrument rating (helicopters) or he has within the immediately preceding 13 months carried out as pilot in command not less than 5 take-offs and 5 landings at a time when the depression of the centre of the sun was not less than 12° below the horizon; or

(ii) on and after 1st September 2001 his licence includes a night rating (helicopters).

(d) He shall not unless his licence includes an instrument rating (helicopters) fly as pilot in command or co-pilot of such a helicopter flying in Class A, B or C airspace in circumstances which require compliance with the Instrument Flight Rules.

(e) On and after 1st September 2001, he shall not fly as pilot in command of such a helicopter carrying passengers unless:

(i) within the preceding 90 days he has made three circuits, each to include take-offs and landings as the sole manipulator of the controls of a helicopter of the same type; or

Status: This is the original version (as it was originally made). This item of legislation is currently only available in its original format.

- (ii) if the privileges are to be exercised by night and his licence does not include an instrument rating, within the preceding 90 days he has made three circuits, each to include take-offs and landings by night as the sole manipulator of the controls of a helicopter of the same type.

Private Pilot's Licence (Gyroplanes)

Minimum age—17 years

No maximum period of validity

Privileges:

(1) Subject to paragraph (2), the holder of the licence shall be entitled to fly as pilot in command or co-pilot of any aeroplane of a type specified in the aircraft rating included in the licence.

- (a) (2) (a) He shall not fly such a gyroplane for the purpose of public transport or aerial work other than aerial work which consists of:
 - (i) the giving of instruction in flying if his licence includes a flying instructor's rating or an assistant flying instructor's rating; or
 - (ii) the conducting of flying tests for the purposes of this Order;in either case in a gyroplane owned, or operated under arrangements entered into, by a flying club of which the person giving the instruction or conducting the test and the person receiving the instruction or undergoing the test are both members.
- (b) He shall not receive any remuneration for his services as a pilot on a flight other than remuneration for the giving of such instruction or the conducting of such flying tests as are specified in sub-paragraph (a).
- (c) He shall not fly as pilot in command of such a gyroplane at night unless his licence includes a night rating (gyroplanes) and he has within the immediately preceding 13 months carried out as pilot in command not less than 5 take-offs and 5 landings at a time when the depression of the centre of the sun was not less than 12° below the horizon.

Commercial Pilot's Licence (Helicopters and Gyroplanes)

Minimum age—18 years

Maximum period of validity—10 years

Privileges:

(1) Subject to paragraph (2), the holder of the licence shall be entitled to exercise the privileges of a Private Pilot's Licence (Helicopters) or a Private Pilot's Licence (Gyroplanes) which includes respectively either a night rating (helicopters) or a night rating (gyroplanes).

- (a) (2) (a) Subject to sub-paragraphs (b) and (c), he shall be entitled to fly as pilot in command of any helicopter or gyroplane on which he is so qualified and which is of a type specified in an aircraft rating included in the licence when the helicopter or gyroplane is engaged on a flight for any purpose whatsoever.
- (b) (i) He shall not, unless his licence includes an instrument rating (helicopters) fly such a helicopter on any scheduled journey or on any flight for the purpose of public transport other than in visual meteorological conditions.
- (ii) He shall not fly such a helicopter on a flight for the purpose of public transport unless it is certificated for single pilot operation.
- (iii) He shall not fly such a helicopter at night prior to 1st September 2001, unless his licence includes an instrument rating (helicopters), or he has within the immediately

preceding 13 months carried out as pilot in command not less than five flights, each consisting of a take-off, a transition from hover to forward flight, a climb to at least 500 ft and a landing, at a time when the depression of the centre of the sun was not less than 12 degrees below the horizon.

- (iv) He shall not fly such a helicopter on any flight for the purpose of public transport after he attains the age of 60 years unless the helicopter is fitted with dual controls and carries a second pilot who has not attained the age of 60 years and who holds an appropriate licence under this Order entitling him to act as pilot in command or co-pilot of that helicopter.
- (v) He shall not unless his licence includes an instrument rating (helicopters) fly as pilot in command of such a helicopter flying in Class A, B or C airspace in circumstances which require compliance with the Instrument Flight Rules.
- (vi) On and after 1st September 2001, he shall not:
 - (aa) fly as pilot in command of a helicopter carrying passengers unless he has carried out at least three circuits, each to include take-offs and landings, as pilot flying in a helicopter of the same type or a flight simulator of the helicopter type to be used, in the preceding 90 days; or
 - (bb) as the holder of a helicopter licence which does not include a valid instrument rating (helicopter) act as pilot in command of a helicopter carrying passengers at night unless during the previous 90 days at least one of the take-offs and landings required in sub-paragraph (aa) above has been carried out at night.
- (c)
 - (i) He shall not fly such a gyroplane on a flight for the purpose of public transport unless it is certificated for single pilot operation.
 - (ii) He shall not fly such a gyroplane at night unless he has within the immediately preceding 13 months carried out as pilot in command not less than five take-offs and five landings at a time when the depression of the centre of the sun was not less than 12° below the horizon.
 - (iii) He shall not fly such a gyroplane on any flight for the purpose of public transport after he attains the age of 60 years unless the gyroplane is fitted with dual controls and carries a second pilot who has not attained the age of 60 years and who holds an appropriate licence under this Order entitling him to act as pilot in command or co-pilot of that gyroplane.
- (a) (3)
 - (a) Subject to sub-paragraph (b) he shall be entitled to fly as co-pilot of any helicopter or gyroplane of a type specified in an aircraft rating included in the licence when the helicopter or gyroplane is engaged on a flight for any purpose whatsoever.
 - (b)
 - (i) He shall not unless his licence includes an instrument rating (helicopters) fly as co-pilot of a helicopter flying in Class A, B or C airspace in circumstances which require compliance with the Instrument Flight Rules.
 - (ii) On and after 1st September 2001, he shall not as co-pilot serve at the flying controls in a helicopter carrying passengers during take-off and landing unless he has served as a pilot at the controls during take-off and landing in a helicopter of the same type or in a flight simulator of the helicopter type to be used, in the preceding 90 days.
 - (iii) He shall not, unless his licence includes an instrument rating (helicopters), fly as co-pilot of a helicopter on any scheduled journey or on any flight for the purpose of public transport other than in visual meteorological conditions.
- (4) He shall not at any time after he attains the age of 65 years act as pilot in command or co-pilot of any helicopter or gyroplane on a flight for the purpose of public transport.

Status: This is the original version (as it was originally made). This item of legislation is currently only available in its original format.

Airline Transport Pilot's Licence (Helicopters and Gyroplanes)

Minimum age—21 years

Maximum period of validity—10 years

Privileges:

The holder of the licence shall be entitled to exercise the privileges of a Commercial Pilot's Licence (Helicopters and Gyroplanes) except that sub-paragraphs (2)(b)(ii) and (2)(c)(i) of those privileges shall not apply.

3. BALLOON AND AIRSHIP PILOTS

Private Pilot's Licence (Balloons and Airships)

Minimum age—17 years

No maximum period of validity

Privileges:

(1) Subject to paragraph (2), the holder of the licence shall be entitled to fly as pilot in command of any type of balloon or airship on which he is so qualified and which is specified in an aircraft rating in the licence and co-pilot of any type of balloon or airship specified in such a rating.

- (a) (2) (a) He shall not fly such a balloon or airship for the purpose of public transport or aerial work, other than aerial work which consists of the giving of instruction in flying or the conducting of flying tests in either case in a balloon or airship owned, or operated under arrangements entered into, by a flying club of which the person giving the instruction or conducting the test and the person receiving the instruction or undergoing the test are both members.
- (b) He shall not receive any remuneration for his services as a pilot on a flight other than remuneration for the giving of such instruction or the conducting of such flying tests as are specified in sub-paragraph (a).
- (c) He shall not fly such a balloon unless he has within the immediately preceding 13 months carried out as pilot in command in a free balloon 5 flights each of not less than 5 minutes duration.

Commercial Pilot's Licence (Balloons)

Minimum age—18 years

*Maximum period of validity—10 years**

Privileges:

(1) The holder of the licence shall be entitled to exercise the privileges of a Private Pilot's Licence (Balloons and Airships).

- (a) (2) (a) Subject to sub-paragraph (b), he shall be entitled to fly, when the balloon is flying for any purpose whatsoever, as pilot in command or co-pilot of any type of balloon specified in the aircraft rating included in the licence.
- (b) He shall not act as pilot in command on a flight for the purpose of the public transport of passengers unless he has within the immediately preceding 90 days carried out as pilot in command in a free balloon 3 flights each of not less than 5 minutes duration.

*In respect of the privileges of a Private Pilot's licence the maximum period of validity shall be as given for that licence.

Commercial Pilot's Licence (Airships)

Minimum age—18 years

Maximum period of validity—10 years

Privileges:

(1) The holder of the licence shall be entitled to exercise the privileges of a Private Pilot's Licence (Balloons and Airships).

(2) He shall be entitled to fly, when the airship is flying for any purpose whatsoever, as pilot in command of any type of airship on which he is so qualified and which is specified in an aircraft rating included in the licence and as co-pilot of any type of airship specified in such a rating.

4. GLIDER PILOTS

Commercial Pilot's Licences (Gliders)

Minimum age—18 years

Maximum period of validity—10 years

Privileges:

The holder of the licence shall be entitled to fly for any purpose as pilot in command or co-pilot of:

- (a) any glider of which the maximum total weight authorised does not exceed 680 kg.
- (b) any glider of which the maximum total weight authorised exceeds 680 kg and which is of a type specified in the rating included in the licence.

5. OTHER FLIGHT CREW

Flight Navigator's Licence

Minimum age—21 years

Maximum period of validity—10 years

Privileges:

The holder of the licence shall be entitled to act as flight navigator in any aircraft.

Flight Engineer's Licence

Minimum age—21 years

Maximum period of validity—10 years

Privileges:

The holder of the licence shall be entitled to act as flight engineer in any type of aircraft specified in an aircraft rating included in the licence.

Flight Radiotelephony Operator's Licence

Minimum age—16 years

Maximum period of validity—10 years

Privileges

The holder of the licence shall be entitled to operate radiotelephony apparatus in any aircraft if the stability of the frequency radiated by the transmitter is maintained automatically but shall not be

Status: This is the original version (as it was originally made). This item of legislation is currently only available in its original format.

entitled to operate the transmitter, or to adjust its frequency, except by the use of external switching devices.

PART B—RATINGS

1. The following ratings may be included in a pilot's licence granted under Part IV of this Order, and, subject to the provisions of this Order and of the licence, the inclusion of a rating in a licence shall have the consequences respectively specified as follows:

Aircraft ratings: The licence shall entitle the holder to act as pilot of aircraft of the types specified in an aircraft rating included in the licence and different types of aircraft may be specified in respect of different privileges of a licence.

Instrument meteorological conditions rating (aeroplanes) shall—

- (a) subject to paragraph (b) entitle the holder of a Private Pilot's Licence (Aeroplanes) or a Basic Commercial Pilot's Licence (Aeroplanes) to fly as pilot in command of an aeroplane without being subject to the restrictions contained respectively in paragraphs (2)(c) and (f) of the privileges of the Private Pilot's Licence (Aeroplanes) or (2)(b)(vii) or (ix) of the privileges of the Basic Commercial Pilot's Licence (Aeroplanes).
- (b) The holder shall not fly:
 - (i) on a special VFR flight in a control zone in a flight visibility of less than 3 km;
 - (ii) when the aeroplane is taking off or landing at any place if the flight visibility below cloud is less than 1800 metres.

Instrument rating (aeroplanes) shall entitle the holder of the licence to act as pilot in command or co-pilot of an aeroplane flying in controlled airspace in circumstances which require compliance with the Instrument Flight Rules.

Instrument rating (helicopters) shall entitle the holder of the licence to act as pilot in command or co-pilot of a helicopter flying in controlled airspace in circumstances which require compliance with the Instrument Flight Rules.

Night rating (aeroplanes) shall entitle the holder of a Private Pilot's Licence (Aeroplanes) or a Basic Commercial Pilot's Licence (Aeroplanes) to act as pilot in command of an aeroplane at night.

Night rating (helicopters) shall entitle the holder of a Private Pilot's Licence (Helicopters) to act as pilot in command of a helicopter at night.

Night rating (gyroplanes) shall entitle the holder of a Private Pilot's Licence (Gyroplanes) to act as pilot in command of a gyroplane at night.

Towing rating (flying machines) shall entitle the holder of the licence to act as pilot of a flying machine while towing a glider in flight for the purposes of public transport or aerial work.

Flying instructor's rating shall entitle the holder of the licence to give instruction in flying aircraft of such types and classes as may be specified in the rating for that purpose.

Assistant flying instructor's rating shall:

- (a) subject to paragraph (b), entitle the holder of the licence to give instruction in flying aircraft of such types as may be specified in the rating for that purpose:
- (b) (i) such instruction shall only be given under the supervision of a person present during the take-off and landing at the aerodrome at which the instruction is to begin and end and holding a pilot's licence endorsed with a flying instructor's rating;

Status: This is the original version (as it was originally made). This item of legislation is currently only available in its original format.

- (ii) an assistant flying instructor’s rating shall not entitle the holder of the licence to give directions to the person undergoing instruction in respect of the performance by that person of:
 - (aa) his first solo flight;
 - (bb) his first solo flight by night;
 - (cc) his first solo cross-country flight otherwise than by night; or
 - (dd) his first solo cross-country flight by night.

2. An aircraft rating included in a flight engineer’s licence shall entitle the holder of the licence to act as flight engineer only of aircraft of a type specified in the aircraft rating.

3. For the purposes of this Schedule:

“Solo flight” means a flight on which the pilot of the aircraft is not accompanied by a person holding a pilot’s licence granted or rendered valid under this Order.

“Cross-country flight” means any flight during the course of which the aircraft is more than 3 nautical miles from the aerodrome of departure.

PART C

CERTIFICATE OF TEST OR EXPERIENCE

- (a) (a) A certificate of test or a certificate of experience required by article 23 of this Order shall not be appropriate to the functions to be performed on a flight unless it is a certificate appropriate to the description of the flight according to the following Table:

<i>Case</i>	<i>Class of licence</i>	<i>Description of flight</i>	<i>Certificate required</i>
A	Private Pilot’s Licence (Aeroplanes)	Any flight within the privileges of the licence	Certificate of test or certificate of experience
	Private Pilot’s Licence (Helicopters)		
	Private Pilot’s Licence (Gyroplanes)		
B	Basic Commercial Pilot’s Licence (Aeroplanes)	Carriage of passengers on a flight in respect of which the holder of the licence receives remuneration	Certificate of test
	Commercial Pilot’s Licence (Aeroplanes)		
	Commercial Pilot’s Licence		

Status: This is the original version (as it was originally made). This item of legislation is currently only available in its original format.

<i>Case</i>	<i>Class of licence</i>	<i>Description of flight</i>	<i>Certificate required</i>
	(Helicopters and Gyroplanes)		
	Commercial Pilot's Licence (Balloons)		
	Commercial Pilot's Licence (Gliders)		
	Commercial Pilot's Licence (Airships)		
	Airline Transport Pilot's Licence (Aeroplanes)		
	Airline Transport Pilot's Licence (Helicopters and Gyroplanes)		
C	Basic Commercial Pilot's Licence (Aeroplanes)	For public transport	Certificate of test
	Commercial Pilot's Licence (Aeroplanes)		
	Commercial Pilot's Licence (Helicopters and Gyroplanes)		
	Commercial Pilot's Licence (Balloons)		
	Commercial Pilot's Licence (Gliders)		
	Commercial Pilot's Licence (Airships)		
	Airline Transport Pilot's Licence (Aeroplanes)		
	Airline Transport Pilot's Licence (Helicopters and Gyroplanes)		
D	Basic Commercial Pilot's Licence (Aeroplanes)	For aerial work	Certificate of test or certificate of experience

Status: This is the original version (as it was originally made). This item of legislation is currently only available in its original format.

<i>Case</i>	<i>Class of licence</i>	<i>Description of flight</i>	<i>Certificate required</i>
	Commercial Pilot's Licence (Aeroplanes)		
	Commercial Pilot's Licence (Helicopters and Gyroplanes)		
	Commercial Pilot's Licence (Balloons)		
	Commercial Pilot's Licence (Gliders)		
	Commercial Pilot's Licence (Airships)		
	Airline Transport Pilot's Licence (Aeroplanes)		
	Airline Transport Pilot's Licence (Helicopters and Gyroplanes)		
E	Basic Commercial Pilot's Licence (Aeroplanes)	Any flight within the privileges of a Private Pilot's Licence	Certificate of test or certificate of experience
	Commercial Pilot's Licence (Aeroplanes)		
	Commercial Pilot's Licence (Helicopters and Gyroplanes)		
	Commercial Pilot's Licence (Balloons)		
	Commercial Pilot's Licence (Gliders)		
	Commercial Pilot's Licence (Airships)		
	Airline Transport Pilot's Licence (Aeroplanes)		
	Airline Transport Pilot's Licence		

Status: This is the original version (as it was originally made). This item of legislation is currently only available in its original format.

<i>Case</i>	<i>Class of licence</i>	<i>Description of flight</i>	<i>Certificate required</i>
	(Helicopters and Gyroplanes)		
F	Flight Navigator's Licence	Flights to which article 20(4) of this Order applies	Certificate of experience
G	Flight Engineer's Licence	For public transport	Certificate of test
H	Flight Engineer's Licence	Any flight other than for public transport	Certificate of test or Certificate of experience

- (b) For the purposes of this Part of this Schedule, references to Cases are references to the Cases indicated in the first Column of the Table in paragraph 1(a) of this Part of this Schedule.

Certificate of test

2. A certificate of test required by article 23 or 24 of this Order shall be signed by a person authorised by the Governor to sign certificates of this kind and shall certify the following particulars:

- (a) the functions to which the certificate relates;
- (b) that the person signing the certificate is satisfied that on a date specified in the certificate the holder of the licence or personal flying logbook of which the certificate forms a part, as the case may be, passed an appropriate test of his ability to perform the functions to which the certificate relates;
- (c) the type of aircraft or flight simulator in or by means of which the test was conducted; and
- (d) the date on which it was signed.

Nature of test

3. The appropriate test referred to in paragraph 2 above shall be:

- (a) in the case of a test which entitles the holder of the licence of which the certificate forms part to act as pilot in command and/or co-pilot of aircraft of the type specified in the certificate, a test of the pilot's competence to fly the aircraft as pilot in command and/or co-pilot and shall, where the Governor so specifies in respect of the whole or part of a test, be conducted in an aircraft in flight or by means of a flight simulator approved by the Governor;
- (b) in the case of a test which entitles the holder of the licence of which the certificate forms part to act as flight engineer of aircraft of the type specified in the certificate, a test of the flight engineer's competence to perform duties of a flight engineer in the type of aircraft to be used on the flight and shall, where the Governor specifies in respect of the whole or part of the test, be conducted in an aircraft in flight or by means of a flight simulator approved by the Governor;
- (c) in the case of a test which entitles the holder of the licence of which the certificate forms part to perform the functions to which an instrument rating relates, a test of his ability to perform the functions to which the rating relates and shall, where the Governor specifies in respect of the whole or part of the test, be conducted in an aircraft in flight or by means of a flight simulator approved by the Governor;

Status: This is the original version (as it was originally made). This item of legislation is currently only available in its original format.

- (d) in the case of a test which entitles the holder of the licence of which the certificate forms part to perform the functions to which a flying instructor's rating, an assistant flying instructor's rating or an instrument meteorological conditions rating relates, a test of his ability to perform the functions to which the rating relates and shall, where the Governor so specifies in respect of the whole or part of the test, be conducted in an aircraft in flight.

Period of validity of certificate of test

- (a) (i) Subject to sub-paragraph (ii), a certificate of test required by article 23(1) of this Order in respect of a Commercial Pilot's Licence (Balloons) shall not be valid in relation to a flight made more than 13 months after the date of the test which it certifies and, in respect of any other licence, shall not be valid in relation to a flight made more than 13 months in Cases A, B, E and H or more than six months in Cases C, D and G after the date of the test which it certifies.
 - (ii) in the case of Cases C, D and G, two certificates of test shall together be deemed to constitute a valid certificate of test if they certify flying tests conducted on two occasions within the period of 13 months preceding the flight on which the functions are to be performed, such occasions being separated by an interval of not less than four months, and if both certificates are appropriate to those functions.
- (b) A certificate of test required by article 24 of this Order shall not be valid in relation to a flight made more than 13 months in the case of an instrument rating (aeroplanes), an instrument rating (helicopters) and an assistant flying instructor's rating or more than 25 months in the case of an instrument meteorological conditions rating (aeroplanes) and a flying instructor's rating after the date of the test which it certifies.

Certificate of experience

5. A certificate of experience required by article 23 of this Order shall be signed by a person authorised by the Governor to sign such a certificate and shall certify the following particulars:

- (a) the functions to which the certificate relates;
- (b) in the case of a pilot or flight engineer, that on the date on which the certificate was signed the holder of the licence or personal flying log book of which it forms part, as the case may be, produced his personal flying log book to the person signing the certificate and satisfied him that he had appropriate experience in the capacity to which his licence relates within the appropriate period specified in paragraph 6 of this Part of this Schedule;
- (c) in the case of a flight navigator, that on the date on which the certificate was signed the holder of the licence of which it forms part produced his navigation logs, charts and workings of astronomical observations to the person signing the certificate and satisfied him that he had appropriate experience in the capacity to which the licence relates within the appropriate period specified in paragraph 6 of this Part of this Schedule;
- (d) in the case of a pilot or flight engineer, the type or types of aircraft in which the experience was gained;
- (e) the date on which it was signed.

Period of experience

6. A certificate of experience shall not be valid unless the experience was gained within the period of 13 months preceding the signing of the certificate in the case of Cases A, E, F and H or six months preceding the signing of the certificate in the case of Case D.

Status: This is the original version (as it was originally made). This item of legislation is currently only available in its original format.

Period of validity of certificate of experience

7. A certificate of experience in respect of a Commercial Pilot's Licence (Balloons.) shall not be valid for more than 13 months after it was signed and in respect of any other licence shall not be valid for more than six months after it was signed for Case D nor for more than 13 months after it was signed for any other case.

SCHEDULE 9

Articles 92(3) and (11)

Air traffic controllers—ratings

- (a) (a) Subject to sub-paragraph (b), the holder of a licence which includes ratings of two or more of the classes specified in paragraph 2 of this Schedule shall not at any one time perform the functions specified in respect of more than one of those ratings.
- (b) The functions of any one of the following groups of ratings may be exercised at the same time:
 - (i) the aerodrome control rating and the approach control rating;
 - (ii) the approach control rating, the approach radar control rating and the area radar control rating; except that the functions of the approach control rating shall not be exercised at the same time as the functions of the approach radar control rating if the service being provided under the latter is a surveillance radar approach terminating at a point less than two nautical miles from the point of intersection of the glide path with the runway.

2. Ratings of the following classes may be included in an air traffic controller's licence (other than a student air traffic controller's licence) granted under article 92 of the Order and, subject to the provision of this Order and of the licence, the inclusion of a rating in a licence shall have the consequences respectively specified as follows:

(1) *An Aerodrome Control Rating shall*, subject to article 92(4) of this Order, entitle the holder of the licence to act as an air traffic controller in the course of the provision of an aerodrome control service but not with any type of radar equipment for which a radar control rating is required under this paragraph.

(2) *An Approach Control Rating shall*, subject to article 92(4) of this Order, entitle the holder of the licence to act as an air traffic controller in the course of the provision of an approach control service but without the aid of any type of radar equipment.

(3) *An Approach Radar Control Rating shall*, subject to article 92(4) of this Order, entitle the holder of the licence to act as an air traffic controller in the course of the provision of an approach control service with the aid of any type of surveillance radar or precision approach radar equipment for any aircraft which is flying not more than 40 nautical miles from the aerodrome traffic zone of the aerodrome in respect of which the service is being provided.

(4) *An Area Radar Control Rating shall*, subject to article 92(4) of this Order, entitle the holder of the licence to act as an air traffic controller in the course of the provision of an area control service at a place other than an area control centre with the aid of any type of surveillance radar equipment.

(5) *An Area Control Centre Rating shall*, subject to article 92(4) of this Order, entitle the holder of the licence to act as an air traffic controller at an area control centre in the course of the provision of an area control service with or without the aid of any type of surveillance radar equipment.

SCHEDULE 10

Articles 16(2) and 31

Public transport—operational requirements

PART A—OPERATIONS MANUAL

- (a) Information and instructions relating to the following matters shall be included in the operations manual referred to in article 31(2) of this Order:
- (i) the number of the crew to be carried in the aircraft, on each stage of any route to be flown, and the respective capacities in which they are to act, and instructions as to the order and circumstances in which command is to be assumed by members of the crew;
 - (ii) the respective duties of each member of the crew and the other members of the operating staff;
 - (iii) the scheme referred to in article 72(1)(c)(i) of this Order;
 - (iv) such technical particulars concerning the aircraft, its engines and equipment and concerning the performance of the aircraft as may be necessary to enable the flight crew of the aircraft to perform their respective duties;
 - (v) the manner in which the quantities of fuel and oil to be carried by the aircraft are to be computed and records of fuel and oil carried and consumed on each stage of the route to be flown are to be maintained; the instructions shall take account of all circumstances likely to be encountered on the flight including the possibility of failure of one or more of the aircraft engines;
 - (vi) the manner in which the quantity, if any, of oxygen and oxygen equipment to be carried in the aircraft for the purpose of complying with Scale L1 or L2 in Schedule 4 to this Order is to be computed;
 - (vii) the check system to be followed by the crew of the aircraft prior to and on take-off, and landing and in an emergency, so as to ensure that the operating procedures contained in the operations manual and in the flight manual or performance schedule forming part of the relevant certificates of airworthiness are complied with;
 - (viii) the circumstances in which a radio watch is to be maintained;
 - (ix) the circumstances in which oxygen is to be used by the crew of the aircraft, and by passengers;
 - (x) subject to paragraph (b), communication, navigational aids, aerodromes, local regulations, in-flight procedures, approach and landing procedures and such other information as the operator may deem necessary for the proper conduct of flight operations; the information referred to in this paragraph shall be contained in a route guide, which may be in the form of a separate volume;
 - (xi) the reporting in flight to the notified authorities of meteorological observations;
 - (xii) subject to paragraph (b), the minimum altitudes for safe flight on each stage of the route to be flown and any planned diversion therefrom such minimum altitudes being not lower than any which may be applicable under the law of the Territory or of the countries whose territory is to be flown over;
 - (xiii) the particulars referred to in article 38 of this Order;
 - (xiv) emergency flight procedures, including procedures for the instruction of passengers in the position and use of emergency equipment and procedures to be adopted when

Status: This is the original version (as it was originally made). This item of legislation is currently only available in its original format.

the commander of the aircraft becomes aware that another aircraft or a vessel is in distress and needs assistance;

- (xv) in the case of aircraft intended to fly at an altitude of more than 49,000 ft the procedures for the use of cosmic radiation detection equipment;
 - (xvi) the labelling and marking of dangerous goods, the manner in which they must be loaded on or suspended beneath an aircraft, the responsibilities of members of the crew in respect of the carriage of dangerous goods and the action to be taken in the event of emergencies arising involving dangerous goods;
 - (xvii) such particulars of any permission granted to the operator pursuant to article 16 of this Order as may be necessary to enable the commander of the aircraft to determine whether he can comply with article 43(b)(ii) of this Order;
 - (xviii) procedures for the operation of any airborne collision avoidance system carried on the aircraft;
 - (xix) a statement of the operator's accident prevention and flight safety programme and of the operator's safety policy;
 - (xx) a list of the post holders responsible for ensuring that the operator's safety policy is fulfilled, showing the duties of each post holder in relation to that policy.
- (b) In relation to any flight which is not one of a series of flights between the same two places it shall be sufficient if, to the extent that it is not practicable to comply with sub-paragraphs (x) and (xii), the manual contains such information and instructions as will enable the equivalent data to be ascertained before take-off.

Article 34

PART B—CREW TRAINING AND TESTS

1. The training, experience, practice and periodical tests required under article 34(3) of this Order in the case of members of the crew of an aircraft engaged on a flight for the purpose of public transport shall be as follows:

Crew

- (1) Every member of the crew shall:
- (a) have been tested within the relevant period by or on behalf of the operator as to his knowledge of the use of the emergency and life saving equipment required to be carried in the aircraft on the flight; and
 - (b) have practised within the relevant period, under the supervision of the operator or of a person appointed by him for the purpose, the carrying out of the duties required of him in case of an emergency occurring to the aircraft, either in an aircraft of the type to be used on the flight or in apparatus approved by the Governor for the purpose and controlled by persons so approved.

Pilots

- (a) (i) Every pilot included in the flight crew who is intended by the operator to fly as pilot in circumstances requiring compliance with the Instrument Flight Rules shall within the relevant period have been tested by or on behalf of the operator:
 - (aa) as to his competence to perform his duties while executing normal manoeuvres and procedures in flight, in an aircraft of the type to be used on the flight, including the use of the instruments and equipment provided in the aircraft;

Status: This is the original version (as it was originally made). This item of legislation is currently only available in its original format.

- (bb) as to his competence to perform his duties in instrument flight conditions while executing emergency manoeuvres and procedures in flight, in an aircraft of the type to be used on the flight, including the use of the instruments and equipment provided in the aircraft.
 - (ii) A pilot's ability to carry out normal manoeuvres and procedures shall be tested in the aircraft in flight.
 - (iii) The other tests required by sub-paragraph (a)(i) may be conducted either in the aircraft in flight, or under the supervision of a person approved by the Governor for the purpose by means of a flight simulator approved by the Governor under article 26(3) of this Order. The tests specified in sub-paragraph (a)(i)(bb) when conducted in the aircraft in flight shall be carried out either in actual instrument flight conditions or in instrument flight conditions simulated by means approved by the Governor.
- (b) Every pilot included in the flight crew whose licence does not include an instrument rating or who, notwithstanding the inclusion of such a rating in his licence, is not intended by the operator to fly in circumstances requiring compliance with the Instrument Flight Rules, shall within the relevant period have been tested, by or on behalf of the operator in flight in an aircraft of the type to be used on the flight:
- (i) as to his competence to act as pilot thereof, while executing normal manoeuvres and procedures; and
 - (ii) as to his competence to act as pilot thereof while executing emergency manoeuvres and procedures.
- (c) Every pilot included in the flight crew who is seated at the flying control during the take-off or landing and who is intended by the operator to fly as pilot in circumstances requiring compliance with the Instrument Flight Rules shall within the relevant period have been tested as to his proficiency in using instrument approach-to-land systems of the type in use at the aerodrome of intended landing and any alternate aerodromes, such test being carried out either at night in instrument flight conditions or in instrument flight conditions simulated by means approved by the Governor or under the supervision of a person approved by the Governor for the purpose by means of a flight simulator approved by the Governor.
- (d) In the case of a helicopter, every pilot included in the flight crew whose licence does not include an instrument rating but who is intended to fly at night under visual flight conditions, shall within the relevant period have been tested, by or on behalf of the operator, in a helicopter of the type to be used on the flight:
- (i) as to his competence to act as pilot thereof, while executing normal manoeuvres and procedures; and
 - (ii) as to his competence to act as pilot thereof, while executing specified manoeuvres and procedures in flight in instrument flight conditions by means approved by the Governor.
- (e) Every pilot included in the flight crew and who is seated at the flying controls during take-off or landing shall within the relevant period have carried out, when seated at the flying controls not less than three take-offs and three landings in aircraft of the type to be used on the flight.

Flight engineers

- (a) (3) (a) Every flight engineer included in the flight crew shall within the relevant period have been tested by or on behalf of the operator:

Status: This is the original version (as it was originally made). This item of legislation is currently only available in its original format.

- (i) as to his competence to perform his duties while executing normal procedures in flight, in an aircraft of the type to be used on the flight;
 - (ii) as to his competence to perform his duties while executing emergency procedures in flight, in an aircraft of the type to be used on the flight.
- (b) A flight engineer's ability to carry out normal procedures shall be tested in an aircraft in flight. The other tests required by this sub-paragraph may be conducted either in the aircraft in flight, or under the supervision of a person approved by the Governor for the purpose by means of a flight simulator approved by the Governor.

Flight navigators and flight radiotelephony operators

(4) Every flight navigator and flight radiotelephony operator whose inclusion in the flight crew is required under articles 20(4) and (5) respectively of this Order shall within the relevant period have been tested by or on behalf of the operator as to his competence to perform his duties in conditions corresponding to those likely to be encountered on the flight:

- (a) in the case of a flight navigator, using equipment of the type to be used in the aircraft on the flight for purposes of navigation;
- (b) in the case of a flight radiotelephony operator using radio equipment of the type installed in the aircraft to be used on the flight, and including a test of his ability to carry out emergency procedures.

Aircraft Commanders

- (a) (5) (a) The pilot designated as commander of the aircraft for the flight shall within the relevant period have demonstrated to the satisfaction of the operator that he has adequate knowledge of the route to be taken, the aerodromes of take-off and landing, and any alternate aerodromes, including in particular his knowledge of:
- (i) the terrain;
 - (ii) the seasonal meteorological conditions;
 - (iii) the meteorological, communications and air traffic facilities, services and procedures;
 - (iv) the search and rescue procedures; and
 - (v) the navigational facilities;

relevant to the route.

- (b) In determining whether a pilot's knowledge of the matters referred to in sub-paragraph (a) is sufficient to render him competent to perform the duties of aircraft commander on the flight, the operator shall take into account the pilot's flying experience in conjunction with the following:
- (i) the experience of other members of the intended flight crew;
 - (ii) the influence of terrain and obstructions on departure and approach procedures at the aerodromes of take-off and intended landing, and at alternate aerodromes;
 - (iii) the similarity of the instrument approach procedures and let-down aids to those with which the pilot is familiar;
 - (iv) the dimensions of runways which may be used in the course of the flight in relation to the performance limits of aircraft of the type to be used on the flight;
 - (v) the reliability of meteorological forecasts and the probability of difficult meteorological conditions in the areas to be traversed;

Status: This is the original version (as it was originally made). This item of legislation is currently only available in its original format.

- (vi) the adequacy of the information available regarding the aerodrome of intended landing and any alternate aerodromes;
 - (vii) the nature of air traffic procedures and the familiarity of the pilot with such procedures;
 - (viii) the influence of terrain on route conditions and the extent of the assistance obtainable en route from navigational aids and air-to-ground communication facilities; and
 - (ix) the extent to which it is possible for the pilot to become familiar with unusual aerodrome procedures and features of the route by means of ground instruction and training devices.
- (6) For the purposes of this paragraph:
- (a) “visual flight conditions” means weather conditions such that the pilot is able to fly by visual reference to objects outside the aircraft;
 - (b) “instrument flight conditions” means weather conditions such that the pilot is unable to fly by visual reference to objects outside the aircraft;
 - (c) “relevant period” means a period which immediately precedes the commencement of the flight, being, subject to sub-paragraph (d), a period:
 - (i) in the case of sub-paragraph (2)(e), of three months;
 - (ii) in the case of sub-paragraphs (2)(a)(i)(bb), (2)(b)(ii), (2)(c), (2)(d)(ii) and (3)(a)(ii), of six months;
 - (iii) in the case of sub-paragraphs (1), (2)(a)(i)(aa), (2)(b)(i), (2)(d)(i), (3)(a)(i), (4) and (5)(a), of 13 months.
 - (d)
 - (i) Any pilot of the aircraft to whom the provisions of sub-paragraphs (2)(a)(i)(bb), (2)(b)(ii) or (2)(c) and any flight engineer of the aircraft to whom the provisions of sub-paragraph (3)(a)(ii) apply shall for the purposes of the flight be deemed to have complied with such requirements respectively within the relevant period if he has qualified to perform his duties in accordance therewith on two occasions within the period of 13 months immediately preceding the flight, such occasions being separated by an interval of not less than four months.
 - (ii) The requirements of sub-paragraph (5)(a) shall be deemed to have been complied with within the relevant period by a pilot designated as commander of the aircraft for the flight if, having become qualified so as to act on flights between the same places over the same route more than 13 months before commencement of the flight, he has within the period of 13 months immediately preceding the flight flown as pilot of an aircraft between those places over that route.

2.—(1) The records required to be maintained by an operator under article 34(4) of this Order shall be accurate and up-to-date records so kept as to show, on any date, in relation to each person who has during the period of two years immediately preceding that date flown as a member of the crew of any public transport aircraft operated by that operator:

- (a) the date and particulars of each test required by this Schedule undergone by that person during the said period including the name and qualifications of the examiner;
- (b) the date upon which that person last practised the carrying out of duties referred to in paragraph 1(1)(b) of this Schedule;
- (c) the operator’s conclusions based on each such test and practice as to that person’s competence to perform his duties;

Status: This is the original version (as it was originally made). This item of legislation is currently only available in its original format.

(d) the date and particulars of any decision taken by the operator during the said period in pursuance of paragraph 1(5)(a) of this Schedule including particulars of the evidence upon which that decision was based.

(2) The operator shall whenever called upon to do so by any authorised person produce for the inspection of any person so authorised all records referred to in the preceding sub-paragraph and furnish to any such person all such information as he may require in connection with any such records and produce for his inspection all log books, certificates, papers and other documents, whatsoever which he may reasonably require to see for the purpose of determining whether such records are complete or of verifying the accuracy of their contents.

(3) The operator shall at the request of any person in respect of whom he is required to keep records as aforesaid furnish to that person, or to any operator of aircraft for the purpose of public transport by whom that person may subsequently be employed, particulars of any qualifications in accordance with this Schedule obtained by such person whilst in his service.

Article 33

PART C—TRAINING MANUAL

The following information and instructions in relation to the training, experience, practice and periodical tests required under article 34(3) of this Order shall be included in the training manual referred to in article 33(3) of this Order:

- (i) the manner in which the training, practice and periodical tests required under article 34(3) and specified in Part B of Schedule 10 to this Order are to be carried out;
- (ii)
 - (a) the minimum qualifications and experience which the operator requires of persons appointed by him to give or to supervise the said training, practice and periodical tests;
 - (b) the type of training, practice and periodical tests which each such person is appointed to give or to supervise; and
 - (c) the type of aircraft in respect of which each such person is appointed to give or to supervise the said training, practice and periodical tests;
- (iii) the minimum qualifications and experience required for each member of the crew undergoing the said training, practice and periodical tests;
- (iv) the syllabus for, and specimen forms for recording, the said training, practice and periodical tests;
- (v) the manner in which instrument flight conditions and engine failure are to be simulated in the aircraft in flight;
- (vi) the extent to which the said training and testing is permitted in the course of flights for the purpose of public transport;
- (vii) the use to be made in the said training and testing of apparatus approved for the purpose by the Governor.

SCHEDULE 11

Articles 76 and 78

Documents to be carried by aircraft registered in the Territory

On a flight for the purpose of public transport:

Document A, B, C, D, E, F, H and, if the flight is international air navigation, Documents G and I.

On a flight for the purpose of aerial work:

Documents A, B, C, E, F, and, if the flight is international air navigation, Documents G and I.

On a private flight, being international air navigation:

Documents A, B, C, G and I.

On a flight made in accordance with the terms of a permission granted to the operator pursuant to article 16 of this Order:

Document J.

For the purposes of this Schedule:

“A” means the licence in force in respect of the aircraft radio station installed in the aircraft;

“B” means the certificate of airworthiness in force in respect of the aircraft, but, with the permission in writing of the Governor, which may be granted subject to such conditions as he thinks fit, an aircraft to which article 31 of this Order applies need not carry the flight manual as part of this document;

“C” means the licences of the members of the flight crew of the aircraft;

“D” means one copy of the load sheet, if any, required by article 35 of this Order in respect of the flight;

“E” means one copy of each certificate of maintenance review, if any, in force in respect of the aircraft;

“F” means the technical log, if any, in which entries are required to be made under article 11 of this Order;

“G” means the certificate of registration in force in respect of the aircraft;

“H” means those parts of the operations manual, if any, required by article 31(2)(a)(iii) of this Order to be carried on the flight;

“I” means a copy of the notified procedures to be followed by the pilot in command of an intercepted aircraft, and the notified visual signals for use by intercepting and intercepted aircraft;

“J” means the permission, if any, granted in respect of the aircraft pursuant to article 16 of this Order, but, with the permission in writing of the Governor, which may be granted subject to such conditions as he thinks fit an aircraft to which article 31 of this Order applies need not carry such a permission if it carries an operations manual which includes the particulars specified at sub-paragraph (xvii) of Part A of Schedule 10 to this Order;

“International air navigation” means any flight which includes passage over the territory of any country other than the Territory.

SCHEDULE 12

Article 122

PENALTIES

PART A—PROVISIONS REFERRED TO IN ARTICLE 122(5)

<i>Article of order</i>	<i>Subject matter</i>
3	Aircraft flying unregistered
5	Aircraft flying with false or incorrect markings

Status: This is the original version (as it was originally made). This item of legislation is currently only available in its original format.

<i>Article of order</i>	<i>Subject matter</i>
10(1)(a)	Flight without appropriate maintenance
10(1)(b)	Flight without a certificate of maintenance review
11	Failure to keep a technical log
12	Flight without a certificate of release to service issued under the Order
13(7) and (8)	Exercise of privileges of aircraft maintenance engineer's licence whilst unfit
14	Flight without required equipment
15	Flight without required radio equipment
16	Minimum equipment requirements
17	Failure to keep log books
18	Requirement to weigh aircraft and keep weight schedule
20	Crew requirement
21	Requirement for appropriate licence
23	Requirement for appropriate certificate of test or experience
24	Requirement for appropriate certificate of test
25(1)	Flight without valid medical certificate
25(2)(a)	Flight in unfit condition
26(1)	Prohibition of flight after failure of test
29	Instruction in flying without appropriate licence and rating
31	Operations manual requirement
32	Police operations manual requirement
33	Training manual requirement
34	Operator's responsibilities in connection with crew
35	Requirements for loading aircraft
36	Operational restrictions on aircraft
37	Prohibition on public transport flights at night or in Instrument Meteorological Conditions by single-engined aeroplanes registered elsewhere than in the Territory
38	Aerodrome operating minima- public transport aircraft registered in the Territory

<i>Article of order</i>	<i>Subject matter</i>
39	Aerodrome operating minima- public transport aircraft registered elsewhere than in the Territory
40	Aerodrome operating minima-non-public transport aircraft
41	Requirement for pilot to remain at controls
43	Pre-flight action by commander of aircraft
44	Requirement for passenger briefing
45	Additional duties of commander on flight for public transport of passengers
46	Requirements for radio station in aircraft to be licensed and for operation of same
47	Requirement for minimum navigation performance equipment
48	Requirement for height keeping performance equipment-aircraft registered in the Territory
49	Requirement for height keeping performance equipment-aircraft registered elsewhere than in the Territory
50	Requirement for area navigation equipment-aircraft registered in the Territory
51	Requirement for area navigation equipment-aircraft registered elsewhere than in the Territory
52	Requirement for an airborne collision avoidance system
53	Use of flight recording systems and preservation of records
54	Towing of gliders
55	Towing, picking up and raising of persons and articles by aircraft
56	Dropping of articles and animals from aircraft
57	Dropping of persons
58	Requirement for aerial application certificate
61	Carriage of persons in or on any part of an aircraft not designed for that purpose
62	Requirement for exits and break-in markings
66	Prohibition of smoking in aircraft
67	Requirement to obey lawful commands of aircraft commander

Status: This is the original version (as it was originally made). This item of legislation is currently only available in its original format.

<i>Article of order</i>	<i>Subject matter</i>
68 (a) and (b)	Acting in a disruptive manner
69	Prohibition of stowaways
70	Flying displays
72(3)	Operator's obligation to obtain flight time records of flight crew
73(2)	Flight crew member's obligation to inform operator of flight times
74	Flight time limitations
84	Breach of the Rules of the Air
85	Flight in contravention of restriction of flying regulations
86	Flight by balloons, kites, airships, gliders and parascending parachutes
87	Flight by small aircraft
90	Provision of air traffic services
91	Use of radio callsigns at aerodromes
94	Requirement for licensing of air traffic controllers
99	Requirement for licensing of flight information service officers
100	Requirement for aerodrome information service manual
101	Requirement for licensed aerodrome
103(5)	Contravention of conditions of aerodrome licence
104	Use of aeronautical radio stations
105	Requirement to keep aeronautical radio station records
109	Use of aeronautical lights
110(1)	Prohibition of dangerous lights
110(2)	Failure to extinguish or screen dangerous lights
112(1) and (3)	Management of aviation fuel at aerodromes
117 (except (4))	Requirement to report occurrences
120	Obstruction of persons performing duties under the Order

PART B—PROVISIONS REFERRED TO IN ARTICLE 122(6)

<i>Article of order</i>	<i>Subject matter</i>
6	Flight for the purpose of public transport without an air operator's certificate
7	Flight in the service of a police authority without a police air operator's certificate
8	Flight without a certificate of airworthiness
59	Prohibition of carriage of weapons and munitions of war
60	Prohibition of carriage of dangerous goods
63	Endangering safety of aircraft
64	Endangering safety of persons or property
65	Prohibition of drunkenness in aircraft
68 (c)	Intentional interference
72(1)	Operator's obligation to regulate flight times of flight crew
72(2)	Operator's obligation not to allow flight by crew in dangerous state of fatigue
73(1)	Crew's obligation not to fly in dangerous state of fatigue
75	Protection of air crew from cosmic radiation
77	Keeping and production of records of exposure to cosmic radiation
83 (except (3))	Use of false or unauthorised documents and records
88	Provision of an air traffic control service without an approval
96	Prohibition of drunkenness etc. of controllers
97	Controller's obligation not to act in a dangerous state of fatigue
112(4)	Use of aviation fuel which is unfit for use in aircraft
113	Restriction of flights for valuable consideration by aircraft registered elsewhere than in the Territory
115	Restriction of flights for aerial photography, aerial survey and aerial work by aircraft registered elsewhere than in the Territory
116	Operators' or commanders' obligations in respect of flights over any foreign country

Status: This is the original version (as it was originally made). This item of legislation is currently only available in its original format.

<i>Article of order</i>	<i>Subject matter</i>
117(4)	Making false reports
118	Flight in contravention of directions not to fly

SCHEDULE 13

Article 84

RULES OF THE AIR

*SECTION I**INTERPRETATION***Interpretation**

1.—(1) In these Rules, unless the context otherwise requires:

“air traffic control clearance” means authorisation by an air traffic control unit for an aircraft to proceed under conditions specified by that unit;

“anti-collision light” means:

- (a) in relation to rotorcraft a flashing red light;
- (b) in relation to any other aircraft a flashing red or flashing white light;

and in either case showing in all directions for the purpose of enabling the aircraft to be more readily detected by the pilots of distant aircraft;

“ground visibility” means the horizontal visibility at ground level;

“IFR flight” means a flight conducted in accordance with the Instrument Flight Rules in Section VI of these Rules;

“runway” means an area, whether or not paved, which is provided for the take-off or landing run of aircraft;

“special VFR flight” means a flight made at any time in a control zone which is Class A airspace, or in any other control zone in Instrument Meteorological Conditions or at night, in respect of which the appropriate air traffic control unit has given permission for the flight to be made in accordance with special instructions given by that unit instead of in accordance with the Instrument Flight Rules and in the course of which flight the aircraft complies with any instructions given by that unit and remains clear of cloud and in sight of the surface;

“VFR flight” means a flight conducted in accordance with the Visual Flight Rules in Section V of these Rules.

(2) In these Rules, unless the context otherwise requires, any reference to:

- (a) a numbered rule is a reference to the rule in these Rules so numbered;
- (b) a numbered paragraph or sub-paragraph is a reference to the paragraph or sub-paragraph so numbered in the rule or paragraph, as the case may be in which that reference appears.

SECTION II

GENERAL

Application of Rules to aircraft

2. These Rules, in so far as they are applicable in relation to aircraft, shall, subject to the provisions of rule 33, apply in relation to:

- (a) all aircraft within the Territory; and
- (b) all aircraft registered in the Territory, wherever they may be.

Misuse of signals and markings

3.—(1) A signal or marking to which a meaning is given by these Rules, or which is required by these Rules to be used in circumstances, or for a purpose therein specified, shall not be used except with that meaning, or for that purpose.

(2) A person in an aircraft or on an aerodrome or at any place at which an aircraft is taking off or landing shall not make any signal which may be confused with a signal specified in these Rules, and, except with lawful authority, shall not make any signal which he knows or ought reasonably to know to be a signal in use for signalling to or from any of Her Majesty's naval, military or air force aircraft.

Reporting hazardous conditions

4. The commander of an aircraft shall, on meeting with hazardous conditions in the course of a flight, or as soon as possible thereafter, send to the appropriate air traffic control unit by the quickest means available information containing such particulars of the hazardous conditions as may be pertinent to the safety of other aircraft.

Low flying

5.—(1) Subject to the provisions of paragraphs (2) and (3):

- (a) an aircraft other than a helicopter shall not fly over any congested area of a city, town or settlement below:
 - (i) such height as would enable the aircraft to alight clear of the area and without danger to persons or property on the surface, in the event of failure of a power unit and if such an aircraft is towing a banner such height shall be calculated on the basis that the banner shall not be dropped within the congested area; or
 - (ii) a height of 1,500 ft above the highest fixed object within 600 metres of the aircraft: whichever is the higher;
- (b) a helicopter shall not fly below such height as would enable it to alight without danger to persons or property on the surface, in the event of failure of a power unit;
- (c) except with the permission in writing of the Governor and in accordance with any conditions therein specified a helicopter shall not fly over a congested area of a city, town or settlement below a height of 1,500 ft above the highest fixed object within 600 metres of the helicopter;
- (d) (i) subject to paragraph (ii) an aircraft shall not fly:
 - (aa) over, or within 1,000 metres of, any assembly in the open air of more than 1,000 persons assembled for the purpose of witnessing or participating in any organised event, except with the permission in writing of the Governor

Status: This is the original version (as it was originally made). This item of legislation is currently only available in its original format.

- and in accordance with any conditions therein specified and with the consent in writing of the organisers of the event; or
- (bb) below such height as would enable it to alight clear of the assembly in the event of the failure of a power unit and if such an aircraft is towing a banner such height shall be calculated on the basis that the banner shall not be dropped within 1,000 metres of the assembly.
- (ii) where a person is charged with an offence under this Order by reason of a contravention of sub-paragraph (d)(i), it shall be a good defence to prove that the flight of the aircraft over, or within 1,000 metres of, the assembly was made at a reasonable height and for a reason not connected with the assembly or with the event which was the occasion for the assembly;
- (e) an aircraft shall not fly closer than 500 feet to any person, vessel, vehicle or structure.
- (a) (2) (a) The provisions of paragraphs (1)(a)(ii) and 1(c) shall not apply to an aircraft flying:
- (i) on a route notified for the purposes of this rule; or
- (ii) on a special VFR flight;
- unless the aircraft is landing or taking off.
- (b) Paragraphs (1)(a)(ii), (1)(c), (1)(d) and (1)(e) shall not apply to an aircraft flying under and in accordance with the terms of a police air operator's certificate.
- (c) Paragraphs (1)(d)(i)(aa) and (1)(e) shall not apply to the flight of an aircraft over or within 1,000 metres of an assembly of persons gathered for the purposes of witnessing or participating in an event which consists:
- (i) wholly or partly of an aircraft race or contest if the aircraft is taking part in such race or contest or is engaged on a flight arranged by, or made with the consent in writing of, the organisers of the event;
- (ii) wholly or partly of a flying display for which a permission under article 70 of this Order is required, if the aircraft is taking part in such display or is engaged on a flight arranged by or made with the consent of the organisers of the event and the flight is made:
- (aa) in accordance with the terms of a permission granted to the flying display director under article 70 of the Order; and
- (bb) in accordance with the conditions of a pilot display authorisation granted to the pilot under article 70 of this Order; or
- (iii) wholly or principally of a flying display for which a permission under article 70 of this Order is not required, if the aircraft is taking part in such display or is engaged on a flight arranged by or made with the consent of the organisers of the event.
- (d) Paragraph (1)(e) shall not apply to:
- (i) any aircraft while it is landing or taking off in accordance with normal aviation practice;
- (ii) any glider while it is hill-soaring;
- (iii) any aircraft while it is flying in accordance with article 56(3)(f) of this Order;
- (iv) any aircraft while it is flying under and in accordance with the terms of an aerial application certificate granted to the operator thereof under article 58 of this Order; or
- (v) any aircraft while it is flying for the purpose of picking up or dropping tow ropes, banners or similar articles at an aerodrome.

(3) Nothing in this rule shall prohibit an aircraft from flying in such a manner as is necessary for the purpose of saving life.

(a) (4) (a) Subject to sub-paragraph (b), nothing in this rule shall prohibit any aircraft from flying in accordance with normal aviation practice, for the purpose of taking off from, landing at or practising approaches to landing at, or checking navigational aids or procedures at, a Government or a licensed aerodrome in the Territory or at any aerodrome in any other country.

(b) The practising of approaches to landing shall be confined to the airspace customarily used by aircraft when landing or taking off in accordance with normal aviation practice at the aerodrome concerned.

(5) Nothing in this rule shall apply to any captive balloon or kite.

Simulated instrument flight

6.—(1) An aircraft shall not be flown in simulated instrument flight conditions unless:

(a) the aircraft is fitted with dual controls which are functioning properly;

(b) an additional pilot (in this rule called a “safety pilot”) is carried in a second control seat of the aircraft for the purpose of rendering such assistance as may be necessary to the pilot flying the aircraft; and

(c) if the safety pilot’s field of vision is not adequate both forward and to each side of the aircraft, a third person, being a competent observer, occupies a position in the aircraft which from his field of vision makes good the deficiencies in that of the safety pilot, and from which he can readily communicate with the safety pilot.

(2) For the purposes of this rule the expression “simulated instrument flight” means a flight during which mechanical or optical devices are used in order to reduce the field of vision or the range of visibility from the cockpit of the aircraft.

Practice instrument approaches

7.—(1) Within the Territory an aircraft shall not carry out instrument approach practice when flying in Visual Meteorological Conditions unless:

(a) the appropriate air traffic control unit has previously been informed that the flight is to be made for the purpose of instrument approach practice; and

(b) if the flight is not being carried out in simulated instrument flight conditions, a competent observer is carried in such a position in the aircraft that he has an adequate field of vision and can readily communicate with the pilot flying the aircraft.

(2) For the purposes of this rule the expression “simulated instrument flight” shall have the same meaning as in rule 6.

SECTION III

LIGHTS AND OTHER SIGNALS TO BE SHOWN OR MADE BY AIRCRAFT

General

8.—(1) For the purposes of this section of these Rules the horizontal plane of a light shown in an aircraft means the plane which would be the horizontal plane passing through the source of that light, if the aircraft were in level flight.

(2) Where by reason of the physical construction of an aircraft it is necessary to fit more than one lamp in order to show a light required by this section of these Rules, the lamps shall be so fitted

Status: This is the original version (as it was originally made). This item of legislation is currently only available in its original format.

and constructed that, so far as is reasonably practicable, not more than one such lamp is visible from any one point outside the aircraft.

(3) Where in these Rules a light is required to show through specified angles in the horizontal plane, the lamps giving such light shall be so constructed and fitted that the light is visible from any point in any vertical plane within those angles throughout angles of 90 degrees above and below the horizontal plane, but, so far as is reasonably practicable, through no greater angle, either in the horizontal plane or the vertical plane.

(4) Where in these Rules a light is required to show in all directions, the lamps giving such light shall be so constructed and fitted that, so far as is reasonably practicable, the light is visible from any point in the horizontal plane and on any vertical plane passing through the source of that light.

Display of lights by aircraft

- (a) **9.** (1) (a) By night an aircraft shall display such of the lights specified in these Rules as may be appropriate to the circumstances of the case, and shall not display any other lights which might obscure or otherwise impair the visibility of, or be mistaken for, such lights.
- (b) By day an aircraft fitted with an anti-collision light shall display such a light in flight.
- (2) A flying machine on an aerodrome in the Territory shall:
 - (a) display by night either the lights which it would be required to display when flying or the lights specified in rule 11(2)(c) unless it is stationary on the apron or part of the aerodrome provided for the maintenance of aircraft;
 - (b) subject to paragraph (3), display when stationary on the apron by day or night with engines running a red anti-collision light, if fitted.
- (3) Notwithstanding the provisions of this section of these Rules the commander of an aircraft may switch off or reduce the intensity of any flashing light fitted to the aircraft if such a light does or is likely to:
 - (a) adversely affect the performance of the duties of any member of the flight crew; or
 - (b) subject an outside observer to unreasonable dazzle.

Failure of navigation and anti-collision lights

10.—(1) In the Territory, in the event of the failure of any light which is required by these Rules to be displayed at night, if the light cannot be immediately repaired or replaced the aircraft shall not depart from the aerodrome and, if in flight, shall land as soon as in the opinion of the commander of the aircraft it can safely do so, unless authorised by the appropriate air traffic control unit to continue its flight.

(2) In the Territory, in the event of a failure of an anti-collision light when flying by day, an aircraft may continue to fly by day provided that the light is repaired at the earliest practicable opportunity.

Flying machines

- 11.**—(1) A flying machine when flying at night shall display lights as follows:
- (a) in the case of a flying machine registered in the Territory having a maximum total weight authorised of more than 5,700 kg or any other flying machine registered in the Territory which conforms to a type first issued with a type certificate on or after 1 January 1991, the system of lights in paragraph (2)(b);
 - (b) in the case of a flying machine registered in the Territory which conforms to a type first issued with a type certificate before 1st January 1991 having a maximum total weight authorised of 5700 kg or less, any one of the following systems of lights:

- (i) that specified in paragraph (2)(a), or that specified in paragraph (2)(b); or
 - (ii) that specified in paragraph (2)(d), excluding sub-paragraph (ii);
 - (c) in the case of any other flying machine one of the systems of lights specified in paragraph (2).
- (2) The systems of lights referred to in paragraph (1) are as follows:
- (a)
 - (i) a steady green light of at least five candela showing to the starboard side through an angle of 110° from dead ahead in the horizontal plane;
 - (ii) a steady red light of at least five candela showing to the port side through an angle of 110° from dead ahead in the horizontal plane; and
 - (iii) a steady white light of at least three candela showing through angles of 70° from dead astern to each side in the horizontal plane;
 - (b)
 - (i) the lights specified in sub-paragraph (a); and
 - (ii) an anti-collision light;
 - (c) the lights specified in sub-paragraph (a), but all being flashing lights flashing together;
 - (d) the lights specified in sub-paragraph (a), but all being flashing lights flashing together in alternation with one or both of the following:
 - (i) a flashing white light of at least twenty candela showing in all directions;
 - (ii) a flashing red light of at least twenty candela showing through angles of 70° from dead astern to each side in the horizontal plane.

(3) If the lamp showing either in red or the green light specified in paragraph (2)(a) is fitted more than 2 metres from the wing tip, a lamp may, notwithstanding the provisions of rule 9(1), be fitted at the wing tip to indicate its position showing a steady light of the same colour through the same angle.

Gliders

12. A glider while flying at night shall display either a steady red light of at least five candela, showing in all directions, or lights in accordance with rule 11(2) and (3).

Free balloons

13. A free balloon while flying at night shall display a steady red light of at least five candela showing in all directions, suspended not less than 5 metres and not more than 10 metres below the basket, or if there is no basket, below the lowest part of the balloon.

Captive balloons and kites

14.—(1) A captive balloon or kite while flying at night at a height exceeding 60 metres above the surface shall display lights as follows:

- (a) a group of two steady lights consisting of a white light placed 4 metres above a red light, both being of at least five candela and showing in all directions, the white light being placed not less than 5 metres or more than 10 metres below the basket, or if there is no basket, below the lowest part of the balloon or kite;
- (b) on the mooring cable, at intervals of not more than 300 metres measured from the group of lights referred to in sub-paragraph (a), groups of two lights of the colour and power and in the relative positions specified in that sub-paragraph, and, if the lowest group of lights is obscured by cloud, an additional group below the cloud base; and
- (c) on the surface, a group of three flashing lights arranged in a horizontal plane at the apexes of a triangle, approximately equilateral, each side of which measures at least 25 metres;

Status: This is the original version (as it was originally made). This item of legislation is currently only available in its original format.

one side of the triangle shall be approximately at right angles to the horizontal projection of the cable and shall be delimited by two red lights; the third light shall be a green light so placed that the triangle encloses the object on the surface to which the balloon or kite is moored.

(2) A captive balloon while flying by day at a height exceeding 60 metres above the surface shall have attached to its mooring cable at intervals of not more than 200 metres measured from the basket, or, if there is no basket, from the lowest part of the balloon, tubular streamers not less than 40 centimetres in diameter and 2 metres in length, and marked with alternate bands of red and white 50 centimetres wide.

(3) A kite flown in the circumstances referred to in paragraph (2) shall have attached to its mooring cable either:

- (a) tubular streamers as specified in paragraph (2), or
- (b) at intervals of not more than 100 metres measured from the lowest part of the kite, streamers not less than 80 centimetres long and 30 centimetres wide at their widest point and marked with alternate bands of red and white 10 centimetres wide.

Airships

15.—(1) Except as provided in paragraph (2), an airship while flying at night shall display the following lights:

- (a) a steady white light of at least five candela showing through angles of 110° from dead ahead to each side in the horizontal plane;
- (b) a steady green light of at least five candela showing to the starboard side through an angle of 110° from dead ahead to each side in the horizontal plane;
- (c) a steady red light of at least five candela showing to the port side through an angle of 110° from dead ahead in the horizontal plane;
- (d) a steady white light of at least five candela showing through angles of 70° from dead astern to each side in the horizontal plane; and
- (e) an anti-collision light.

(a) (2) (a) Subject to sub-paragraph (b), an airship while flying at night shall display, if it is not under command, or has voluntarily stopped its engines, or is being towed, the following steady lights:

- (i) the white lights referred to in paragraph (1)(a) and (d);
- (ii) two red lights, each of at least five candela and showing in all directions suspended below the control car so that one is at least 4 metres above the other and at least 8 metres below the control car; and
- (iii) if the airship is making way but not otherwise, the green and red lights referred to in paragraph (1)(b) and (c).

(b) An airship while picking up its moorings, notwithstanding that it is not under command, shall display only the lights specified in paragraph (1).

(3) An airship, while moored within the Territory by night, shall display the following steady lights:

- (a) when moored to a mooring mast, at or near the rear a white light of at least five candela showing in all directions;
- (b) when moored otherwise than to a mooring mast:
 - (i) a white light of at least five candela showing through angles of 110° from dead ahead to each side in the horizontal plane; and

(ii) a white light of at least five candela showing through angles of 70° from dead astern to each side in the horizontal plane.

(4) An airship while flying by day, if it is not under command, or has voluntarily stopped its engines, or is being towed, shall display two black balls suspended below the control car so that one is at least 4 metres above the other and at least 8 metres below the control car.

(5) For the purposes of this rule:

- (a) an airship shall be deemed not to be under command when it is unable to execute a manoeuvre which it may be required to execute by or under these Rules;
- (b) an airship shall be deemed to be making way when it is not moored and is in motion relative to the air.

SECTION IV

GENERAL FLIGHT RULES

Weather reports and forecasts

16.—(1) Immediately before an aircraft flies the commander of the aircraft shall examine the current reports and forecasts of the weather conditions on the proposed flight path, being reports and forecasts which it is reasonably practicable for him to obtain, in order to determine whether Instrument Meteorological Conditions prevail or are likely to prevail during any part of the flight.

(2) An aircraft which is unable to communicate by radio with an air traffic control unit at the aerodrome of destination shall not begin a flight to an aerodrome within a control zone if the information which it is reasonably practicable for the commander of the aircraft to obtain indicates that it will arrive at that aerodrome when the ground visibility is less than 10 km or the cloud ceiling is less than 1,500 feet, unless the commander of the aircraft has obtained from an air traffic control unit at that aerodrome permission to enter the aerodrome traffic zone.

Rules for avoiding aerial collisions

General

General

- (a) 17. (1) (a) Notwithstanding that the flight is being made with air traffic control clearance it shall remain the duty of the commander of an aircraft to take all possible measures to ensure that his aircraft does not collide with any other aircraft.
- (b) An aircraft shall not be flown in such proximity to other aircraft as to create a danger of collision.
- (c) Subject to sub-paragraph (g), aircraft shall not fly in formation unless the commanders of the aircraft have agreed to do so.
- (d) An aircraft which is obliged by these Rules to give way to another aircraft shall avoid passing over or under the other aircraft, or crossing ahead of it, unless passing well clear of it.
- (e) Subject to sub-paragraph (g), an aircraft which has the right-of-way under this rule shall maintain its course and speed.
- (f) For the purposes of this rule a glider and a flying machine which is towing it shall be considered to be a single aircraft under the command of the commander of the towing flying machine.

Status: This is the original version (as it was originally made). This item of legislation is currently only available in its original format.

- (g) Sub-paragraphs (c) and (e) shall not apply to an aircraft flying under and in accordance with the terms of a police air operator's certificate.

Converging

- (a) (2) (a) Subject to the provisions of paragraphs (3) and (4), an aircraft in the air shall give way to other converging aircraft as follows:
 - (i) flying machines shall give way to airships, gliders and balloons;
 - (ii) airships shall give way to gliders and balloons;
 - (iii) gliders shall give way to balloons.
- (b) (i) Subject to the provisions of sub-paragraphs (a) and (b)(ii), when two aircraft are converging in the air at approximately the same altitude, the aircraft which has the other on its right shall give way.
- (ii) Mechanically driven aircraft shall give way to aircraft which are towing other aircraft or objects.

Approaching head-on

(3) When two aircraft are approaching head-on or approximately so in the air and there is danger of collision, each shall alter its course to the right.

Overtaking

- (a) (4) (a) Subject to sub-paragraph (b), an aircraft which is being overtaken in the air shall have the right-of-way and the overtaking aircraft, whether climbing, descending or in horizontal flight, shall keep out of the way of the other aircraft by altering course to the right, and shall not cease to keep out of the way of the other aircraft until that other aircraft has been passed and is clear, notwithstanding any change in the relative positions of the two aircraft.
- (b) A glider overtaking another glider in the Territory may alter its course to the right or to the left.

Flight in the vicinity of an aerodrome

(5) Without prejudice to the provisions of rule 39, a flying machine, glider or airship while flying in the vicinity of what the commander of the aircraft knows or ought reasonably to know to be an aerodrome, or moving on an aerodrome, shall, unless in the case of an aerodrome having an air traffic control unit that unit otherwise authorises:

- (a) conform to the pattern of traffic formed by other aircraft intending to land at that aerodrome, or keep clear of the airspace in which the pattern is formed; and
- (b) make all turns to the left unless ground signals otherwise indicate.

Order of landing

- (a) (6) (a) An aircraft while landing or on final approach to land shall have the right-of-way over other aircraft in flight or on the ground or water.
- (b) (i) Subject to sub-paragraph (ii), in the case of two or more flying machines, gliders or airships approaching any place for the purpose of landing, the aircraft at the lower altitude shall have the right-of-way, but it shall not cut in front of another aircraft which is on final approach to land or overtake that aircraft.
- (ii) (aa) When an air traffic control unit has communicated to any aircraft an order of priority for landing, the aircraft shall approach to land in that order.

Status: This is the original version (as it was originally made). This item of legislation is currently only available in its original format.

- (bb) When the commander of an aircraft is aware that another aircraft is making an emergency landing, he shall give way to that aircraft, and at night, notwithstanding that he may have received permission to land, shall not attempt to land until he has received further permission so to do.

Landing and take-off

- (a) (7) (a) A flying machine, glider or airship shall take off and land in the direction indicated by the ground signals or, if no such signals are displayed, into the wind, unless good aviation practice demands otherwise.
- (b) A flying machine or glider shall not land on a runway at an aerodrome if the runway is not clear of other aircraft unless, in the case of an aerodrome having an air traffic control unit, that unit otherwise authorises.
- (c) Where take-offs and landings are not confined to a runway:
 - (i) a flying machine or glider when landing shall leave clear on its left any aircraft which has landed or is already landing or about to take off; if such a flying machine or glider is about to turn it shall turn to the left after the commander of the aircraft has satisfied himself that such action will not interfere with other traffic movements; and
 - (ii) a flying machine about to take off shall take up position and manoeuvre in such a way as to leave clear on its left any aircraft which has already taken off or is about to take off.
- (d) A flying machine after landing shall move clear of the landing area as soon as it is possible to do so unless, in the case of an aerodrome having an air traffic control unit, that unit otherwise authorises.

Aerobatic manoeuvres

- 18.** An aircraft shall not carry out any aerobatic manoeuvre:
- (a) over the congested area of any city, town or settlement; or
 - (b) within controlled airspace except with the consent of the appropriate air traffic control unit.

Right-hand traffic rule

19.—(1) Subject to paragraph (2), an aircraft which is flying within the Territory in sight of the ground and following a road, railway, canal, or coastline, or any other line of landmarks, shall keep such line of landmarks to its left.

(2) Paragraph (1) shall not apply to an aircraft flying within controlled airspace in accordance with instructions given by the appropriate air traffic control unit.

Notification of arrival and departure

20.—(1) The commander of an aircraft who has caused notice of its intended arrival at any aerodrome to be given to the air traffic control unit or other authority at that aerodrome shall ensure that the air traffic control unit or other authority at that aerodrome is informed as quickly as possible of any change of intended destination and any estimated delay in arrival of 45 minutes or more.

(2) The commander of an aircraft arriving at or departing from an aerodrome in the Territory shall take all reasonable steps to ensure upon landing or prior to departure, as the case may be, that notice of that event is given to the person in charge of the aerodrome, or to the air traffic control unit or aerodrome flight information service unit at the aerodrome.

Status: This is the original version (as it was originally made). This item of legislation is currently only available in its original format.

(3) Without prejudice to the provisions of rules 27 and 31, before taking off on any flight from an aerodrome in the Territory being a flight whose intended destination is more than 40 km from the aerodrome of departure, the commander of an aircraft of which the maximum total weight authorised exceeds 5,700 kg shall cause a flight plan containing such particulars of the intended flight as may be necessary for search and rescue purposes to be communicated to the air traffic control unit notified for the purpose of this rule.

Flight in Class A airspace

21.—(1) Subject to paragraph (2), in relation to flights in Visual Meteorological Conditions in Class A airspace, the commander of an aircraft shall comply with rules 31 and 32 as if the flights were IFR flights but shall not elect to continue the flight in compliance with the Visual Flight Rules for the purposes of rule 31(4).

(2) Paragraph (1) shall not apply to the commander of a glider which is flying in Class A airspace which is notified for the purpose of this paragraph if the glider is flown in accordance with conditions such as may also be notified for the purpose of this paragraph in respect of that airspace.

Choice of VFR or IFR

22.—(1) Subject to paragraph (2) and to the provisions of rule 21 an aircraft shall always be flown in accordance with the Visual Flight Rules or the Instrument Flight Rules.

(2) In the Territory an aircraft flying at night:

- (a) outside a control zone shall be flown in accordance with the Instrument Flight Rules;
- (b) in a control zone shall be flown in accordance with the Instrument Flight Rules unless it is flying on a special VFR flight.

Speed Limitation

23.—(1) Subject to paragraph (3), an aircraft shall not fly below flight level 100 at a speed which according to its air speed indicator is more than 250 knots unless it is flying in accordance with the terms of a written permission of the Governor.

(2) The Governor may grant a permission for the purpose of this rule subject to such conditions as he thinks fit and either generally or in respect of any aircraft or class of aircraft.

(3) Paragraph (1) shall not apply to:

- (a) flight in Class A airspace;
- (b) VFR flight or IFR flight in Class B airspace;
- (c) IFR flight in Class C airspace;
- (d) VFR flight in Class C airspace or VFR flight or IFR flight in Class D airspace when authorised by the appropriate air traffic control unit;
- (e) the flight of an aircraft taking part in an exhibition of flying for which a permission under article 70 of the Order is required, if the flight is made in accordance with the terms of a permission granted to the organiser of the exhibition of flying under article 70 of the Order, and in accordance with the conditions of a display authorisation granted to the pilot under article 70 of the Order; or
- (f) the flight of an aircraft flying in accordance with the “A Conditions” or the “B Conditions” set forth in Schedule 3 Part A to this Order.

SECTION V
VISUAL FLIGHT RULES

Visual flight and reported visibility

24.—(1) In relation to flights within controlled airspace rules 25 and 27 shall be the Visual Flight Rules.

(2) In relation to flights outside controlled airspace rule 26 shall be the Visual Flight Rules.

(3) For the purposes of an aeroplane taking off from or approaching to land at an aerodrome within Class B, C, or D airspace, the visibility, if any, communicated to the commander of an aeroplane by the appropriate air traffic control unit shall be taken to be the flight visibility for the time being.

Flight within controlled airspace

25.—(1) Within Class B airspace:

- (a) an aircraft flying within Class B airspace at or above flight level 100 shall remain clear of cloud and in a flight visibility of at least 8 km;
- (b) an aircraft flying within Class B airspace below flight level 100 shall remain clear of cloud and in a flight visibility of at least 5 km.

(2) Within Class C, Class D or Class E airspace:

- (a) an aircraft flying within Class C, Class D or Class E airspace at or above flight level 100 shall remain at least 1,500 metres horizontally and 1,000 feet vertically away from cloud and in a flight visibility of at least 8 km;
- (b) subject to sub-paragraph (c), an aircraft flying within Class C, Class D or Class E airspace below flight level 100 shall remain at least 1,500 metres horizontally and 1,000 feet vertically away from cloud and in a flight visibility of at least 5 km;
- (c) sub-paragraph (b) shall be deemed to be complied with if:
 - (i) the aircraft is not a helicopter and is flying at or below 3,000 feet above mean sea level at a speed which, according to its airspeed indicator, is 140 knots or less and it remains clear of cloud, in sight of the surface and in a flight visibility of at least 5 km; or
 - (ii) the aircraft is a helicopter flying at or below 3,000 feet above mean sea level and it remains clear of cloud and in sight of the surface.

Flight outside controlled airspace

26.—(1) An aircraft flying outside controlled airspace at or above flight level 100 shall remain at least 1,500 metres horizontally and 1,000 feet vertically away from cloud and in a flight visibility of at least 8 km.

- (a) (2) (a) Subject to sub-paragraph (b), an aircraft flying outside controlled airspace below flight level 100 shall remain at least 1,500 metres horizontally and 1,000 feet vertically away from cloud and in a flight visibility of at least 5 km.
- (b) Sub-paragraph (a) shall be deemed to be complied with if:
 - (i) the aircraft is flying at or below 3,000 feet above mean sea level and remains clear of cloud and in sight of the surface and in a flight visibility of at least 5 km;
 - (ii) the aircraft, other than a helicopter, is flying at or below 3,000 feet above mean sea level at a speed which according to its air speed indicator is 140 knots or less and

Status: This is the original version (as it was originally made). This item of legislation is currently only available in its original format.

remains clear of cloud and in sight of the surface and in a flight visibility of at least 1,500 metres; or

- (iii) in the case of a helicopter the helicopter is flying at or below 3,000 feet above mean sea level at a speed, which having regard to the visibility is reasonable, and remains clear of cloud and in sight of the surface.

VFR flight plan and air traffic control clearance

27.—(1) Unless otherwise authorised by the appropriate air traffic control unit, before an aircraft flies within Class B, Class C or Class D airspace during the notified hours of watch of the appropriate air traffic control unit, the commander of the aircraft shall cause a flight plan to be communicated to the appropriate air traffic control unit and shall obtain an air traffic control clearance to fly within the said airspace.

(2) The flight plan shall contain such particulars of the flight as may be necessary to enable the air traffic control unit to issue a clearance and for search and rescue purposes.

(3) Without prejudice to paragraph (2), any flight plan for a flight within Territory reduced vertical separation minimum airspace shall state whether or not the aircraft is equipped with height keeping systems as required by articles 48 or 49.

(4) Whilst flying within the said airspace during the notified hours of watch of the appropriate air traffic control unit the commander of the aircraft shall:

- (a) cause a continuous watch to be maintained on the notified radio frequency appropriate to the circumstances; and
- (b) comply with any instructions which the appropriate air traffic control unit may give in a particular case.

(5) Paragraphs (1), (2) and (3) shall not apply in respect of:

- (a) any glider flying or intending to fly in Class B airspace notified for the purpose of this sub-paragraph;
- (b) any glider flying during the day in controlled airspace notified for the purpose of this sub-paragraph which remains at least 1,500 metres horizontally and 1,000 feet vertically away from cloud and in a flight visibility of at least 8 km; or
- (c) any mechanically driven aircraft without radio equipment flying during the day in controlled airspace notified for the purposes of this sub-paragraph which remains at least 1,500 metres horizontally and 1,000 feet vertically away from cloud and in a flight visibility of at least 5 km the commander of which has previously obtained the permission of the appropriate air traffic control unit to fly within the said airspace.

SECTION VI

INSTRUMENT FLIGHT RULES

Instrument Flight Rules

28.—(1) In relation to flights within controlled airspace rules 29, 31 and 32 shall be the Instrument Flight Rules.

(2) In relation to flights outside controlled airspace rules 29 and 30 shall be the Instrument Flight Rules.

Status: This is the original version (as it was originally made). This item of legislation is currently only available in its original format.

Minimum height

29. Without prejudice to the provisions of rule 5, in order to comply with the Instrument Flight Rules an aircraft shall not fly at a height of less than 1,000 feet above the highest obstacle within a distance of 5 nautical miles of the aircraft unless:

- (a) it is necessary for the aircraft to do so in order to take off or land;
- (b) the aircraft is flying on a route notified for the purposes of this rule;
- (c) the aircraft has been otherwise authorised by the competent authority; or
- (d) the aircraft is flying at an altitude not exceeding 3,000 feet above mean sea level and remains clear of cloud and in sight of the surface.

Quadrantal rule and semi-circular rule

30.—(1) Subject to paragraph (2), in order to comply with the Instrument Flight Rules, an aircraft when in level flight above 3,000 feet above mean sea level or above the appropriate transition altitude, whichever is the higher, shall be flown at a level appropriate to its magnetic track, in accordance with the appropriate Table set forth in this rule. The level of flight shall be measured by an altimeter set:

- (a) in the case of a flight over the Territory, to a pressure setting of 1013.2 hectopascals; or
- (b) in the case of any other flight, according to the system published by the competent authority in relation to the area over which the aircraft is flying.

(2) An aircraft may be flown at a level other than the level required by paragraph (1) if it is flying in conformity with instructions given by an air traffic control unit or in accordance with notified en-route holding patterns or in accordance with holding procedures notified in relation to an aerodrome.

(3) For the purposes of this rule “transition altitude” means the altitude so notified in relation to flight over such area or areas as may be notified.

Table I—Flights at levels below 24,000 feet

<i>Magnetic track</i>	<i>Cruising level</i>
Less than 90°	Odd thousands of feet
90° but less than 180°	Odd thousands of feet + 500 feet
180° but less than 270°	Even thousands of feet
270° but less than 360°	Even thousands of feet + 500 feet

Table II—Flights at levels above 24,500 feet

<i>Magnetic track</i>	<i>Cruising level</i>
Less than 180°	25,000 feet
	27,000 feet
	29,000 feet or higher levels at intervals of 4,000 feet
180° but less than 360°	26,000 feet
	28,000 feet

Status: This is the original version (as it was originally made). This item of legislation is currently only available in its original format.

Magnetic track

Cruising level

31,000 feet or higher levels at intervals of 4,000 feet

Flight plan and air traffic control clearance

31.—(1) In order to comply with the Instrument Flight Rules, before an aircraft either takes off from a point within any controlled airspace or otherwise flies within any controlled airspace the commander of the aircraft shall cause a flight plan to be communicated to the appropriate air traffic control unit and shall obtain an air traffic control clearance based on such flight plan.

(2) The flight plan shall contain such particulars of the intended flight as may be necessary to enable the air traffic control unit to issue an air traffic control clearance, and for search and rescue purposes.

(3) Without prejudice to paragraph (2), any flight plan for a flight within Territory reduced vertical separation minimum airspace shall state whether or not the aircraft is equipped with height keeping systems as required by articles 48 or 49.

(a) (4) (a) Subject to sub-paragraph (b), the commander of the aircraft shall fly in conformity with:

(i) the air traffic control clearance issued for the flight, as amended by any further instructions given by an air traffic control unit; and

(ii) the holding and instrument approach procedures notified in relation to the aerodrome of destination, unless he is otherwise authorised by the air traffic control unit there.

(b) The commander of the aircraft shall not be required to comply with sub-paragraph (a) if:

(i) he is able to fly in uninterrupted Visual Meteorological Conditions for so long as he remains in controlled airspace; and

(ii) he has informed the appropriate air traffic control unit of his intention to continue the flight in compliance with Visual Flight Rules and has requested that unit to cancel his flight plan.

(5) If for the purpose of avoiding immediate danger any departure is made from the provisions of paragraph (4) (as is permitted by article 84(3) of this Order) the commander of the aircraft shall, in addition to causing particulars to be given in accordance with article 84(4) of this Order, as soon as possible inform the appropriate air traffic control unit of the deviation.

(6) The commander of the aircraft after it has flown in controlled airspace shall, unless he has requested the appropriate air traffic control unit to cancel his flight plan, forthwith inform that unit when the aircraft lands within or leaves the controlled airspace.

Position reports

32. In order to comply with the Instrument Flight Rules the commander of an aircraft in IFR flight who flies in or is intending to enter controlled airspace shall report to the appropriate air traffic control unit the time, position and level of the aircraft at such reporting points or at such intervals of time as may be notified for this purpose or as may be directed by the air traffic control unit.

SECTION VII

AERODROME TRAFFIC RULES

Application of aerodrome traffic rules

33. The rules in this section of these Rules which are expressed to apply to flying machines shall also be observed, so far as is practicable, in relation to all other aircraft.

Visual signals

34.—(1) Subject to paragraph (2), the commander of a flying machine on, or in the pattern of traffic at, an aerodrome shall observe such visual signals as may be displayed at, or directed to him from the aerodrome by the authority of the person in charge of the aerodrome and shall obey any instructions which may be given to him by means of such signals.

(2) The commander of such a flying machine shall not be required to obey the signals referred to in rule 47 (Marshalling Signals) if in his opinion it is inadvisable to do so in the interests of safety.

Movement of aircraft on aerodromes

35. An aircraft shall not taxi on the apron or the manoeuvring area of an aerodrome without the permission of the person in charge of the aerodrome or, where the aerodrome has an air traffic control unit or an aerodrome flight information service unit for the time being notified as being on watch, without the permission of that unit.

Access to and movement of persons and vehicles on the aerodrome

36.—(1) A person or vehicle shall not go onto any part of an aerodrome (not being a part of the aerodrome which is a public right of way) without the permission of the person in charge of that part of the aerodrome, and except in accordance with any conditions subject to which that permission may have been granted.

(2) A vehicle or person shall not go or move on the manoeuvring area of an aerodrome having an air traffic control unit or aerodrome flight information service unit without the permission of that unit, and except in accordance with any conditions subject to which that permission may have been granted.

(3) Any permission granted for the purposes of this rule may be granted either in respect of persons or vehicles generally, or in respect of any particular person or vehicle or any class of person or vehicle.

Right of way on the ground

37.—(1) This rule shall apply to flying machines and vehicles on any part of a land aerodrome provided for the use of aircraft and under the control of the person in charge of the aerodrome.

(2) Notwithstanding any air traffic control clearance it shall remain the duty of the commander of an aircraft to take all possible measures to ensure that his aircraft does not collide with any other aircraft or with any vehicle.

(a) (3) (a) Flying machines and vehicles shall give way to aircraft which are taking off or landing.

(b) Vehicles, and flying machines which are not taking off or landing, shall give way to vehicles towing aircraft.

(c) Vehicles which are not towing aircraft shall give way to aircraft.

(4) Subject to the provisions of paragraph (3) and of rule 17(7)(c), in case of danger of collision between two flying machines:

(a) when the two flying machines are approaching head-on or approximately so, each shall alter its course to the right;

(b) when the two flying machines are on converging courses, the one which has the other on its right shall give way to the other and shall avoid crossing ahead of the other unless passing well clear of it;

Status: This is the original version (as it was originally made). This item of legislation is currently only available in its original format.

- (c) a flying machine which is being overtaken shall have the right-of-way, and the overtaking flying machine shall keep out of the way of the other flying machine by altering its course to the left until that other flying machine has been passed and is clear, notwithstanding any change in the relative positions of the two flying machines.
- (5) Subject to the provisions of paragraphs (3)(b) a vehicle shall:
 - (a) overtake another vehicle so that the other vehicle is on the left of the overtaking vehicle;
 - (b) keep to the left when passing another vehicle which is approaching head-on or approximately so.

Launching, picking up and dropping of tow ropes, etc.

38.—(1) Tow ropes, banners or similar articles towed by aircraft shall not be launched at an aerodrome except in accordance with arrangements made with the air traffic control unit at the aerodrome or, if there is no such unit, with the person in charge of the aerodrome.

(2) Tow ropes, banners or similar articles towed by aircraft shall not be picked up by or dropped from aircraft at an aerodrome except:

- (a) in accordance with arrangements with the air traffic control unit at the aerodrome or, if there is no such unit, with the person in charge of the aerodrome; or
- (b) in the area designated by the marking described in rule 44(7), and the ropes, banners or similar articles shall be picked up and dropped when the aircraft is flying in the direction appropriate for landing.

Flight within aerodrome traffic zones

39.—(1) Paragraphs (2) and (3) shall apply only in relation to such of the aerodromes described in Column 1 of the following Table as are notified for the purposes of this rule and at such times as are specified in Column 2 thereof.

TABLE

<i>Column 1</i>	<i>Column 2</i>
(a) (a) A government aerodrome	at such times as are notified
(b) (b) An aerodrome having an air traffic control unit or an aerodrome flight information service unit	during the notified hours of watch of the air traffic control unit or the aerodrome flight information service unit
A licensed aerodrome having a means of two way radio communication with aircraft	during the notified hours of watch of the air/ground radio station

(2) An aircraft shall not fly, take off or land within the aerodrome traffic zone of an aerodrome to which this paragraph applies unless the commander of the aircraft has obtained the permission of the air traffic control unit at the aerodrome or, where there is no air traffic control unit, has obtained from the aerodrome flight information service unit at that aerodrome information to enable the flight within the zone to be conducted with safety or, where there is no air traffic control unit nor aerodrome flight information unit, has obtained information from the air/ground radio station at that aerodrome to enable the flight to be conducted with safety.

(3) The commander of an aircraft flying within the aerodrome traffic zone of an aerodrome to which this paragraph applies shall:

Status: This is the original version (as it was originally made). This item of legislation is currently only available in its original format.

- (a) cause a continuous watch to be maintained on the appropriate radio frequency notified for communications at the aerodrome or, if this is not possible, cause a watch to be kept for such instructions as may be issued by visual means;
- (b) where the aircraft is fitted with means of communication by radio with the ground, communicate his position and height to the air traffic control unit, the aerodrome flight information service unit or the air/ground radio station at the aerodrome (as the case may be), on entering the zone and immediately prior to leaving it.

*SECTION VIII
SPECIAL RULES*

Use of radio navigation aids

40.—(1) Subject to paragraph (2), the commander of an aircraft shall not make use of any radio navigation aid without complying with such restrictions and appropriate procedures as may be notified in relation to that aid unless authorised by an air traffic control unit.

(2) The commander of an aircraft shall not be required to comply with this rule if he is required to comply with rule 31.

*SECTION IX
AERODROME SIGNALS AND MARKINGS—VISUAL AND AURAL SIGNALS*

General

41.—(1) Whenever any signal specified in this section of these Rules is given or displayed, or whenever any marking so specified is displayed, by any person in an aircraft, or at an aerodrome, or at any other place which is being used by aircraft for landing or take-off, it shall, when given or displayed in the Territory, have the meaning assigned to it in this section.

(2) All dimensions other than those in rule 45(6), of signals or markings specified in this section of these Rules (but not distances at which markings must be placed) shall be subject to a tolerance of 10 per cent, plus or minus.

42.—(1) When any signal specified in the following paragraphs of this rule is displayed it shall be placed in a signals area, which shall be a square visible from all directions bordered by a white strip 30 centimetres wide the internal sides measuring 12 metres.

(2) A white landing T, as illustrated in this paragraph,

Status: This is the original version (as it was originally made). This item of legislation is currently only available in its original format.

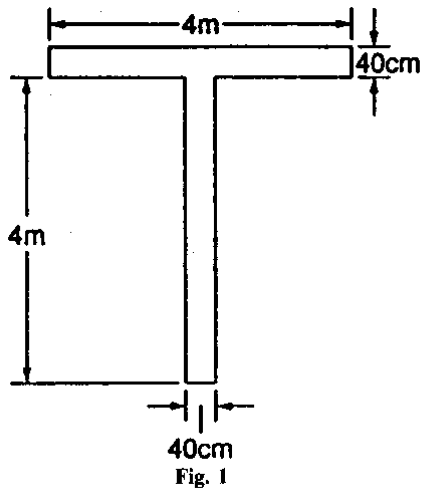

signifies that aeroplanes and gliders taking off or landing shall do so in a direction parallel with the shaft of the T and towards the cross arm, unless otherwise authorised by the appropriate air traffic control unit.

(3) A white disc 60 centimetres in diameter displayed alongside the cross arm of the T and in line with the shaft of the T, as illustrated in this paragraph,

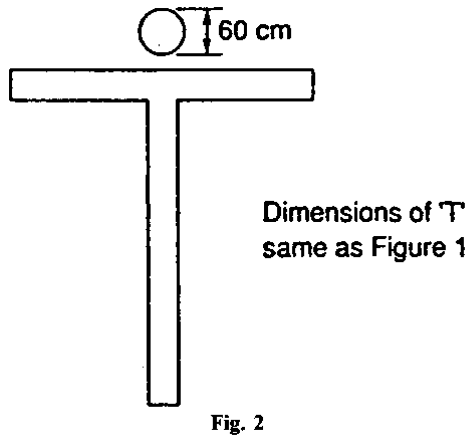

signifies that the direction of landing and take off do not necessarily coincide.

(4) A white dumb-bell, as illustrated in this paragraph,

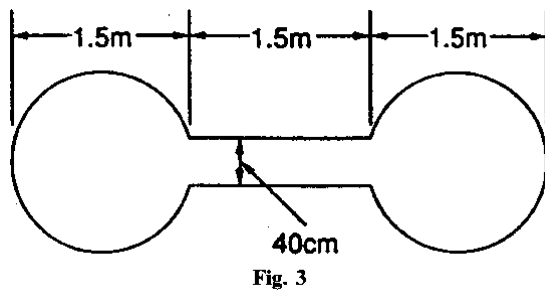

signifies that movements of aeroplanes and gliders on the ground shall be confined to paved, metallised or similar hard surfaces.

Status: This is the original version (as it was originally made). This item of legislation is currently only available in its original format.

(5) A white dumb-bell as described in (4) but with a black strip 60 centimetres wide across each disc at right angles to the shaft of the dumb-bell, as illustrated in this paragraph,

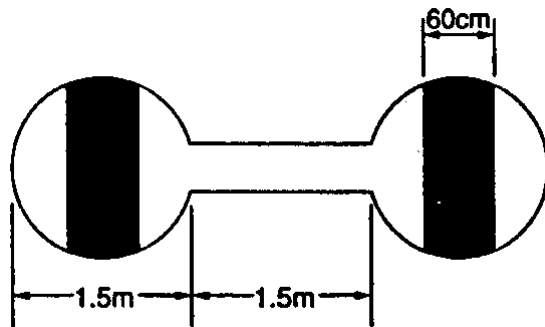

Fig. 4

signifies that aeroplanes and gliders taking off or landing shall do so on a runway but that movement on the ground is not confined to paved, metalled or similar hard surfaces.

(6) A red and yellow striped arrow, as illustrated in this paragraph,

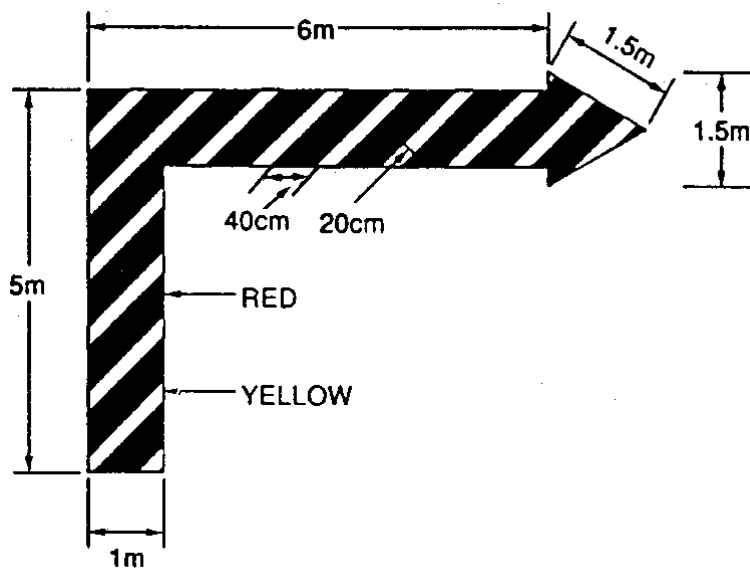
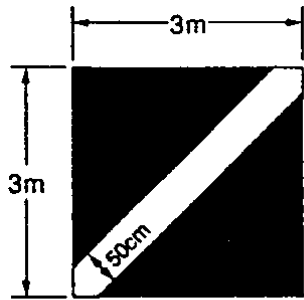

Fig. 5

the shaft of which is one metre wide placed along the whole or a total of 11 metres of two adjacent sides of the signals area and pointing in a clockwise direction signifies that a right-hand circuit is in force.

(7) A red panel 3 metres square with a yellow strip along one diagonal 50 centimetres wide, as illustrated in this paragraph,

Status: This is the original version (as it was originally made). This item of legislation is currently only available in its original format.



Yellow strip on red background

Fig. 6

signifies that the state of the manoeuvring area is poor and pilots must exercise special care when landing.

(8) A red panel 3 metres square with a yellow strip, 50 centimetres wide, along each diagonal, as illustrated in this paragraph,

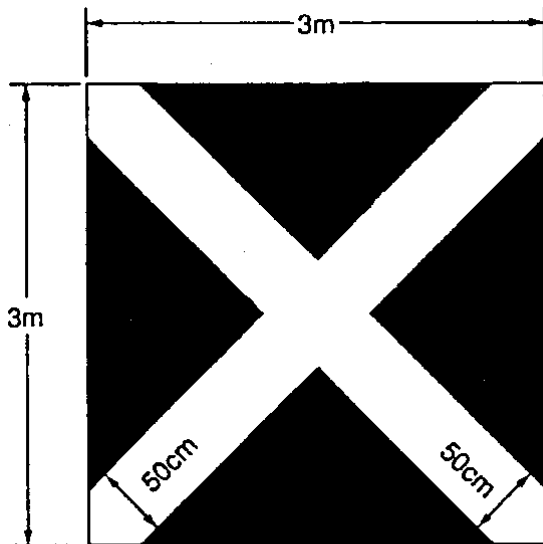

Yellow strips on red background

Fig. 7

signifies that the aerodrome is unsafe for the movement of aircraft and that landing on the aerodrome is prohibited.

(9) A white letter H, as illustrated in this paragraph,

Status: This is the original version (as it was originally made). This item of legislation is currently only available in its original format.

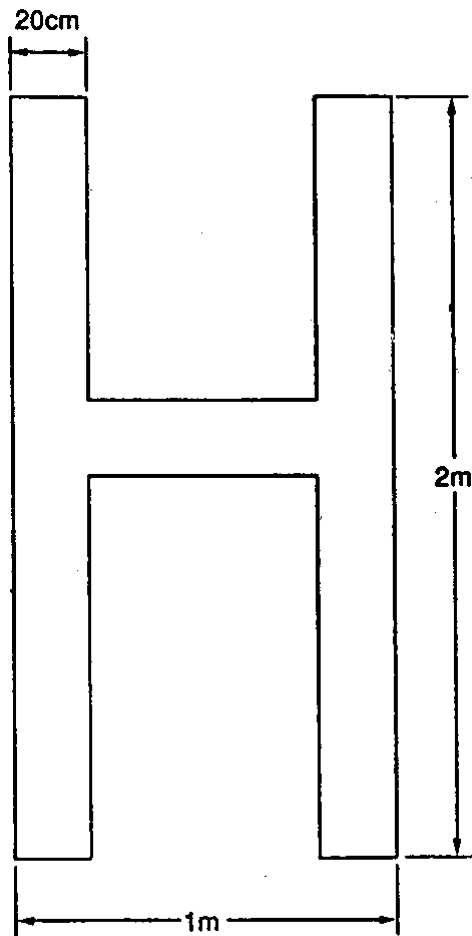

Fig. 8

signifies that helicopters shall take off and land only within the area designated by the marking specified in rule 44(5).

(10) A red letter L displayed on the dumb-bell specified in paragraphs (4) and (5), as illustrated in this paragraph,

Status: This is the original version (as it was originally made). This item of legislation is currently only available in its original format.

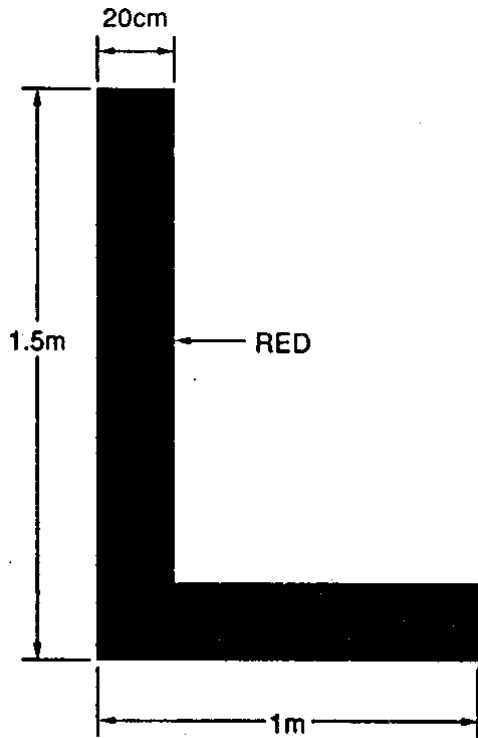

Fig. 9

signifies that light aircraft are permitted to take off and land either on a runway or on the area designated by the marking specified in rule 44(6).

(11) A white double cross, as illustrated in this paragraph,

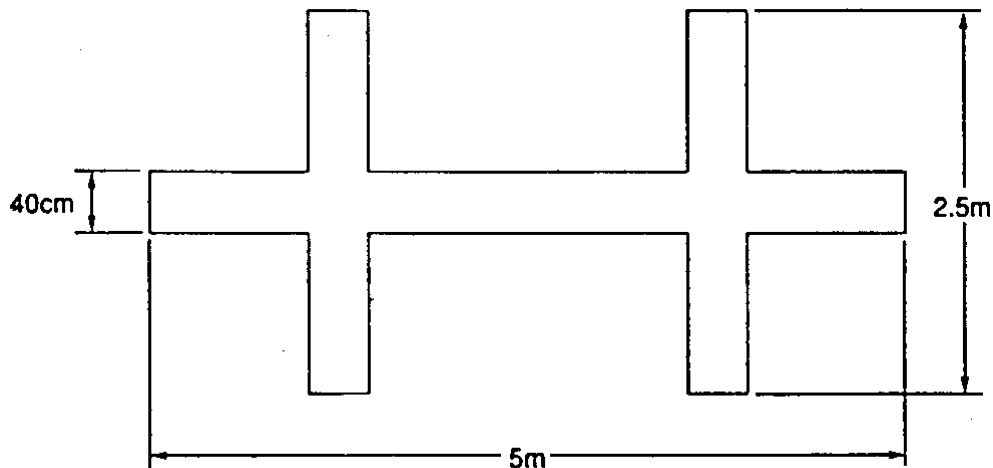

Fig. 10

signifies that glider flying is in progress.

Markings for paved runways and taxiways

43.—(1) Two or more white crosses, as illustrated in this paragraph,

Status: This is the original version (as it was originally made). This item of legislation is currently only available in its original format.

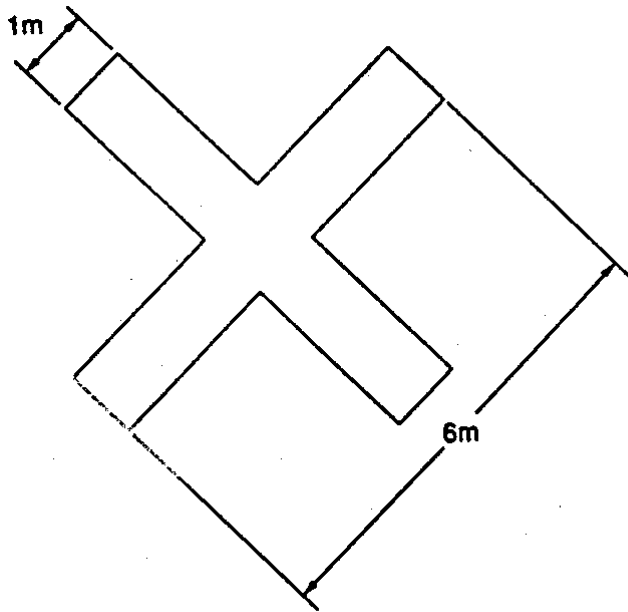

Fig. 11

displayed on a runway or taxiway, with each arm of each cross at an angle of 45° to the centre line of the runway, at intervals of not more than 300 metres signify that the section of the runway or taxiway marked by them is unfit for the movement of aircraft.

- (a) (2) (a) Two yellow broken lines and two continuous lines, as illustrated in this paragraph,

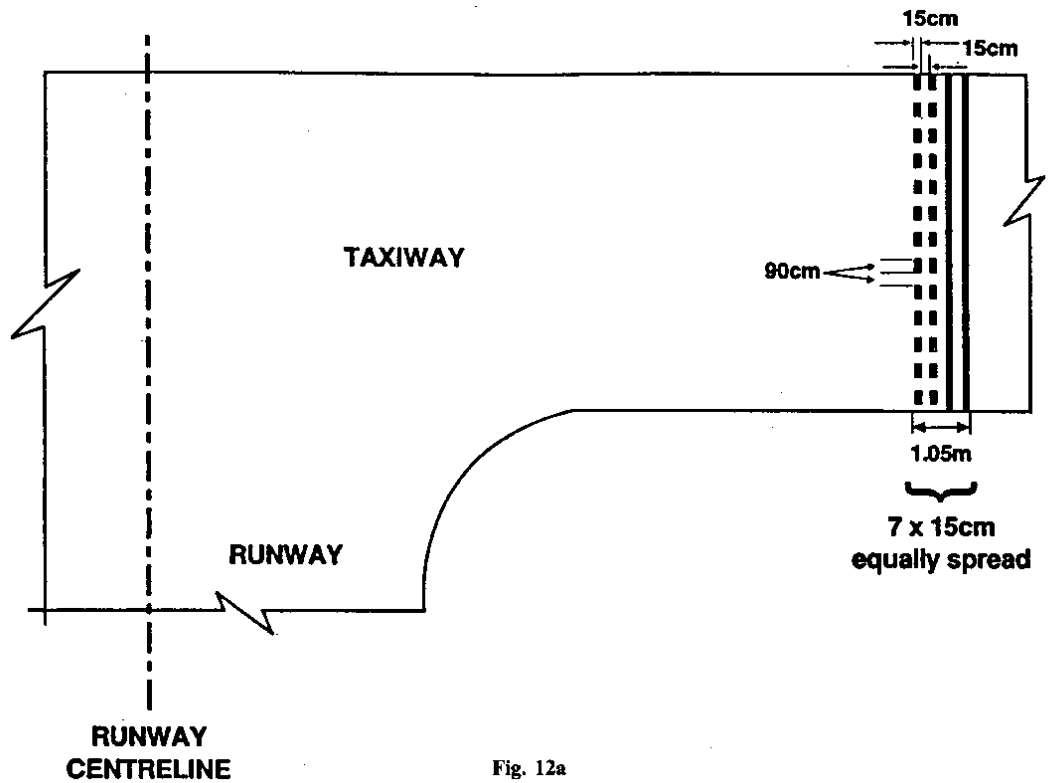

Fig. 12a

Status: This is the original version (as it was originally made). This item of legislation is currently only available in its original format.

signify the holding position closest to the runway beyond which no part of a flying machine or vehicle shall project in the direction of the runway without permission from the air traffic control unit at the aerodrome during the notified hours of watch of that unit. Outside the notified hours of watch of that unit or where there is no air traffic control unit at the aerodrome the markings signify the position closest to the runway beyond which no part of a flying machine or vehicle shall project in the direction of the runway when the flying machine or vehicle is required by virtue of rule 37(3)(a) of these Rules to give way to aircraft which are taking off from or landing on that runway.

- (b) A yellow marking, as illustrated in this paragraph,

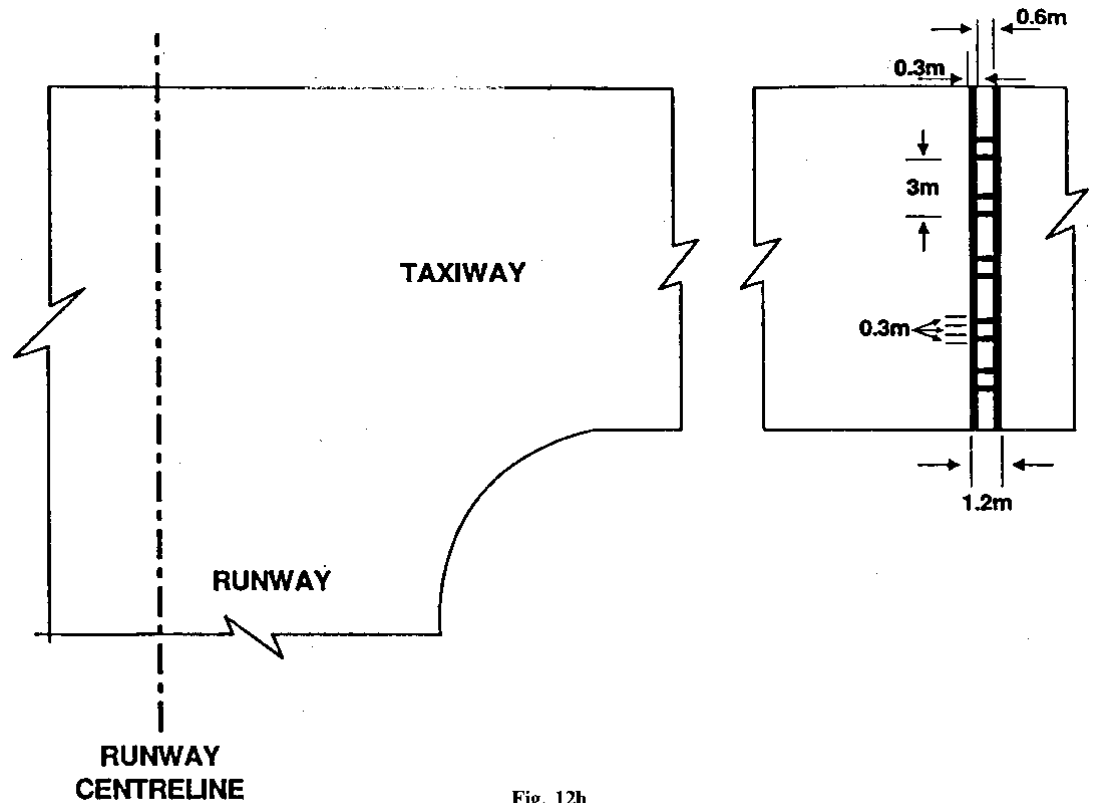

Fig. 12b

signifies a holding position other than that closest to the runway beyond which no part of a flying machine or vehicle shall project in the direction of the runway without permission from the air traffic control unit at the aerodrome during the notified hours of watch of that unit. Outside the notified hours of watch of that unit or where there is no air traffic control unit at the aerodrome the marking may be disregarded.

- (3) Orange and white markers, as illustrated in this paragraph,

Status: This is the original version (as it was originally made). This item of legislation is currently only available in its original format.

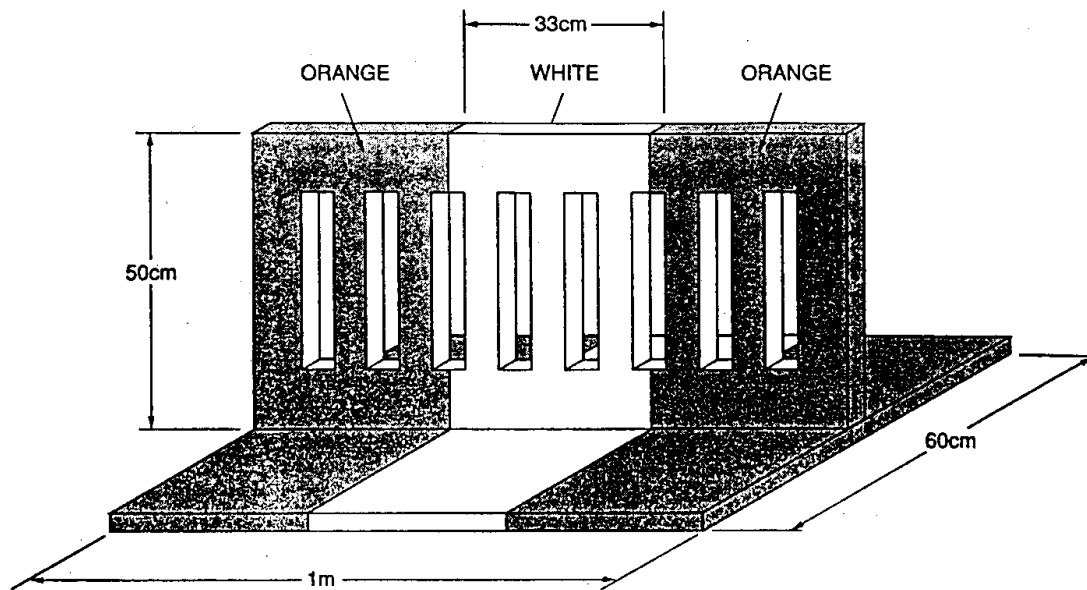

Fig. 13

spaced no more than 15 metres apart, signify the boundary of that part of a paved runway, taxiway or apron which is unfit for the movement of aircraft.

Markings on unpaved manoeuvring areas

44.—(1) Markers with orange and white stripes of an equal width of 50 centimetres, with an orange stripe at each end, as illustrated in this paragraph,

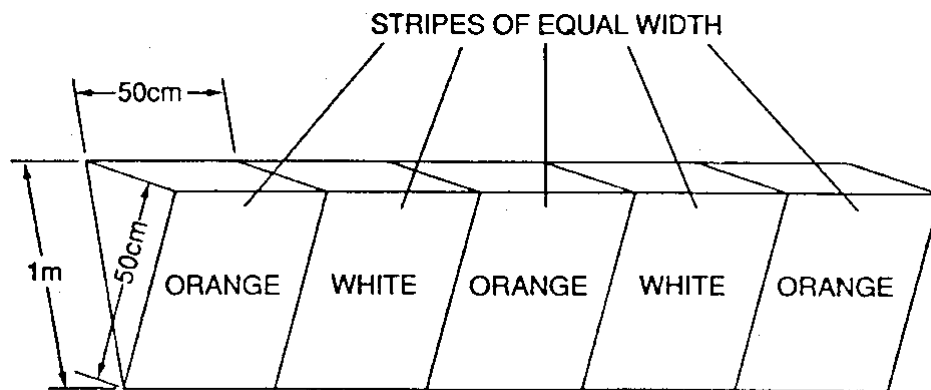

Fig. 14

alternating with flags 60 centimetres square showing equal orange and white triangular areas, indicate the boundary of an area unfit for the movement of aircraft and one or more white crosses as specified in rule 43(1) indicate the said area. The distance between any two successive orange and white flags shall not exceed 90 metres.

(2) Striped markers, as specified in paragraph (1), spaced not more than 45 metres apart, indicate the boundary of an aerodrome.

(3) On structures, markers with orange and white vertical stripes, of an equal width of 50 centimetres, with an orange stripe at each end, as illustrated in this paragraph,

Status: This is the original version (as it was originally made). This item of legislation is currently only available in its original format.

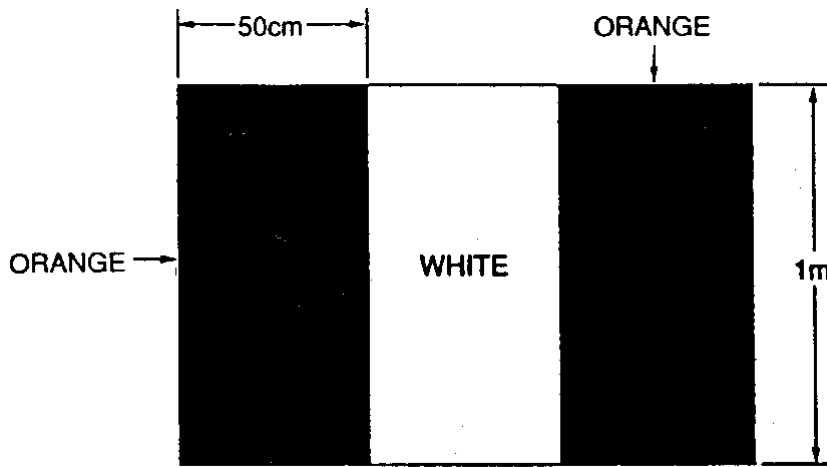

Fig. 15

spaced not more than 45 metres apart, indicate the boundary of an aerodrome. The pattern of the marker shall be visible from inside and outside the aerodrome and the marker shall be affixed not more than 15 centimetres from the top of the structure.

(4) White flat rectangular markers 3 metres long and 1 metre wide at intervals not exceeding 90 metres, flush with the surface of the unpaved runway or stopway, as the case may be, indicate the boundary of an unpaved runway or of a stopway.

(5) A white letter H, as illustrated in this paragraph,

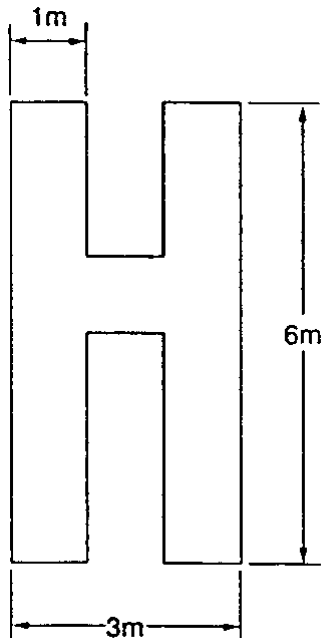

Fig. 16

indicates an area which shall be used only for the taking off and landing of helicopters.

(6) A white letter L, as illustrated in this paragraph,

Status: This is the original version (as it was originally made). This item of legislation is currently only available in its original format.

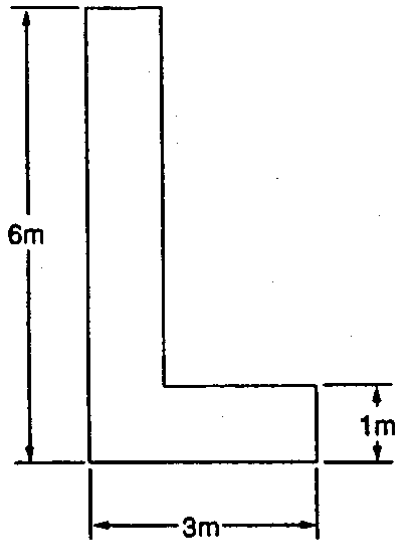

Fig. 17

indicates a part of the manoeuvring area which shall be used only for the taking off and landing of light aircraft.

(7) A yellow cross with two arms each 6 metres long by 1 metre wide at right angles, indicates that tow ropes, banners and similar articles towed by aircraft shall only be picked up and dropped in the area in which the cross is placed.

(8) A white double cross, as illustrated in this paragraph,

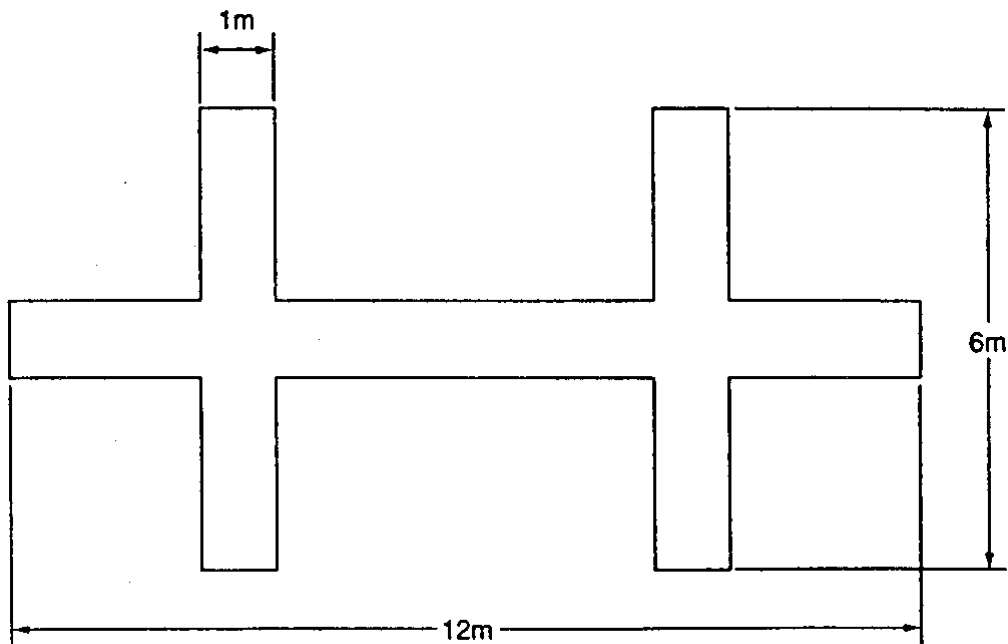

Fig. 18

indicates an area which shall be used only for the taking off and landing of gliders.

(9) A white landing T as specified in rule 42(2) placed at the left-hand side of the runway when viewed from the direction of landing indicates the runway to be used, and at an aerodrome with no runway it indicates the direction for take off and landing.

Status: This is the original version (as it was originally made). This item of legislation is currently only available in its original format.

Signals visible from the ground

45.—(1) A black ball 60 centimetres in diameter suspended from a mast signifies that the directions of take off and landing are not necessarily the same.

(2) A checkered flag or board, 1.2 metres by 90 centimetres containing twelve equal squares, 4 horizontally and 3 vertically, coloured red and yellow alternately, signifies that aircraft may move on the manoeuvring area and apron only in accordance with the permission of the air traffic control unit at the aerodrome.

(3) Two red balls 60 centimetres in diameter, disposed vertically one above the other, 60 centimetres apart and suspended from a mast, signify that glider flying is in progress at the aerodrome.

(4) Black arabic numerals in two-figure groups and, where parallel runways are provided the letter or letters L (left), LC (left centre), C (centre), RC (right centre) and R (right), phased against a yellow background, indicate the direction for take off or the runway in use.

(5) A black letter C against a yellow background, as illustrated in this paragraph, indicates the position at which a pilot can report to the air traffic control unit or to the person in charge of the aerodrome.

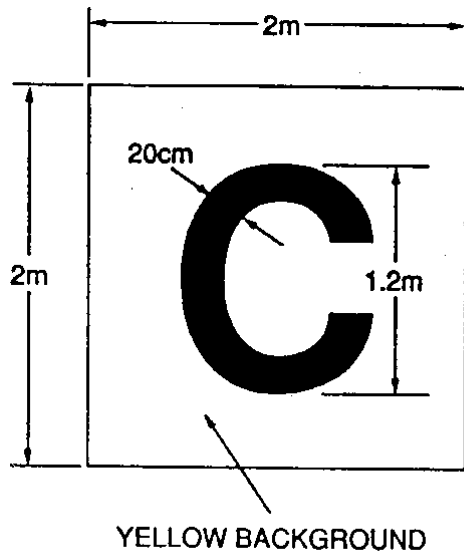

Fig. 19

(6) A rectangular green flag not less than 60 centimetres square and not more than 66 centimetres square flown from a mast indicates that a right-hand circuit is in force.

Lights and pyrotechnic signals for control of aerodrome traffic

46. Each signal described in the first column of Table A, when directed from an aerodrome to an aircraft or to a vehicle, or from an aircraft, shall have the meanings respectively appearing in the second, third and fourth columns of that Table opposite the description of the signal.

Status: This is the original version (as it was originally made). This item of legislation is currently only available in its original format.

Table A—Meaning of Lights and Pyrotechnic Signals

<i>Characteristic and colour of light beam or pyrotechnic</i>	<i>From an aerodrome</i>		
	<i>to an aircraft in flight</i>	<i>to an aircraft or vehicle on the aerodrome</i>	<i>From an aircraft in flight to an aerodrome</i>
(a) (a) Continuous red light.	Give way to other aircraft and continue circling.	Stop.	—
(b) (b) Red pyrotechnic light, or red flare.	Do not land; wait for permission.	—	Immediate assistance is requested.
(c) (c) Red flashes.	Do not land; aerodrome not available for landing.	Move clear of landing area.	—
(d) (d) Green flashes.	Return to aerodrome; wait for permission to land.	To an aircraft: you may move on the manoeuvring area and apron. To a vehicle: you may move on the manoeuvring area.	—
(e) (e) Continuous green light.	You may land.	You make take off (not applicable to a vehicle).	—
(f) (f) Continuous green light, or green flashes, or green pyrotechnic light.	—	—	By night: may I land? By day: may I land in direction different from that indicated by landing T?
(g) (g) White flashes.	Land at this aerodrome after receiving continuous green light, and then, after receiving green flashes, proceed to the apron.	Return to starting point on the aerodrome.	I am compelled to land.
(h) (h) White pyrotechnic lights. Switching on and off the navigation lights. Switching on and off the	—	—	I am compelled to land.

Status: This is the original version (as it was originally made). This item of legislation is currently only available in its original format.

<i>Characteristic and colour of light beam or pyrotechnic</i>	<i>From an aerodrome</i>		<i>From an aircraft in flight to an aerodrome</i>
	<i>to an aircraft in flight</i>	<i>to an aircraft or vehicle on the aerodrome</i>	
landing lights.			

Marshalling signals (from a marshaller to an aircraft)

47. Each of the signals for the guidance of aircraft manoeuvring on or off the ground, described in the first column of Table B, paragraphs (a) to (x) shall, in the Territory, have the meanings set forth in the second column of that Table opposite the description of the signal. By day any such signals shall be given by hand or by circular bats and by night by torches or illuminated wands (save that the signals described at paragraphs (v) and (w) shall not be given at night).

Table B

Meaning of marshalling signals (rule 47)

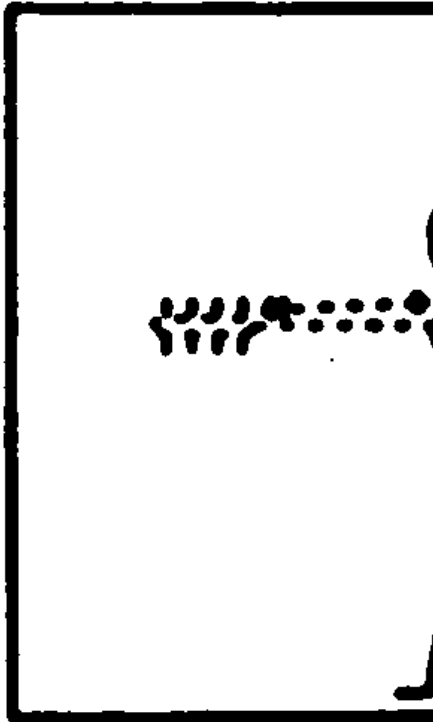
<i>Description of signal</i>	<i>Meaning of signal</i>	<i>In daylight</i>	<i>By night</i>
(a) (a) Right or left arm down, other arm moved across body and extended to indicate position of the other marshaller.	Proceed under guidance of another marshaller.		

Status: This is the original version (as it was originally made). This item of legislation is currently only available in its original format.

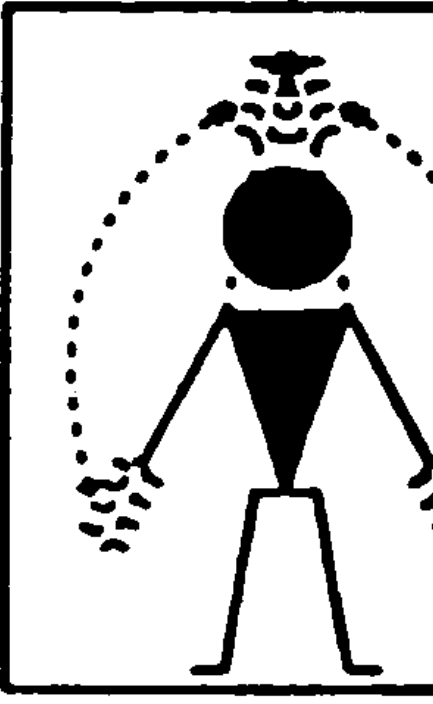
<i>Description of signal</i>	<i>Meaning of signal</i>	<i>In daylight</i>	<i>By night</i>
(b) (b) Arms repeatedly moved upward and backward, beckoning onward.	Move ahead.		

Status: This is the original version (as it was originally made). This item of legislation is currently only available in its original format.

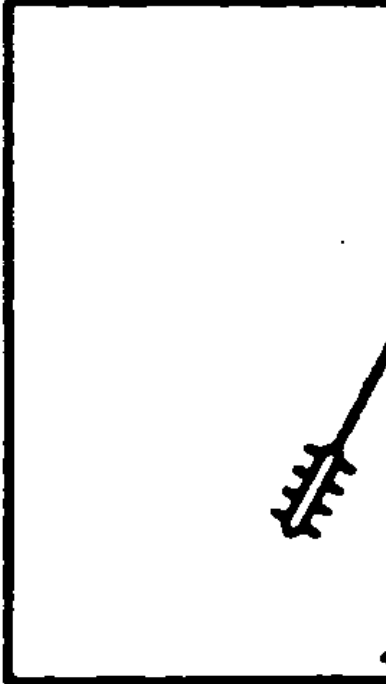
<i>Description of signal</i>	<i>Meaning of signal</i>	<i>In daylight</i>	<i>By night</i>
(c) (c) Right arm down, left arm repeatedly moved upward and backward. The speed of arm movement indicates the rate of turn.	Open up starboard engine or turn to port.		

Status: This is the original version (as it was originally made). This item of legislation is currently only available in its original format.

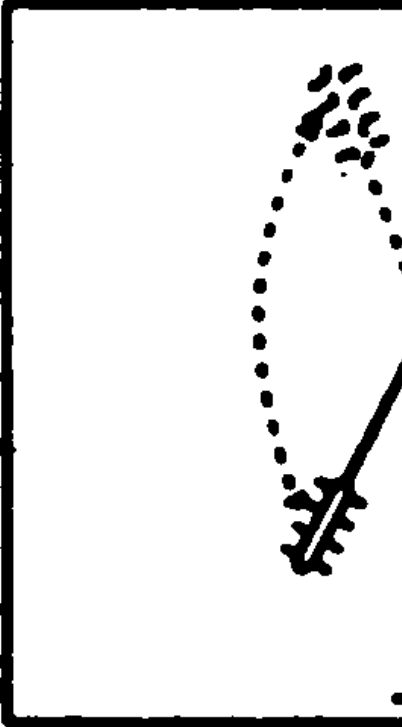
<i>Description of signal</i>	<i>Meaning of signal</i>	<i>In daylight</i>	<i>By night</i>
(d) (d) Left arm down, the right arm repeatedly moved upward and backward. The speed of arm movement indicates the rate of turn.	Open up port engine or turn to starboard.		

Status: This is the original version (as it was originally made). This item of legislation is currently only available in its original format.

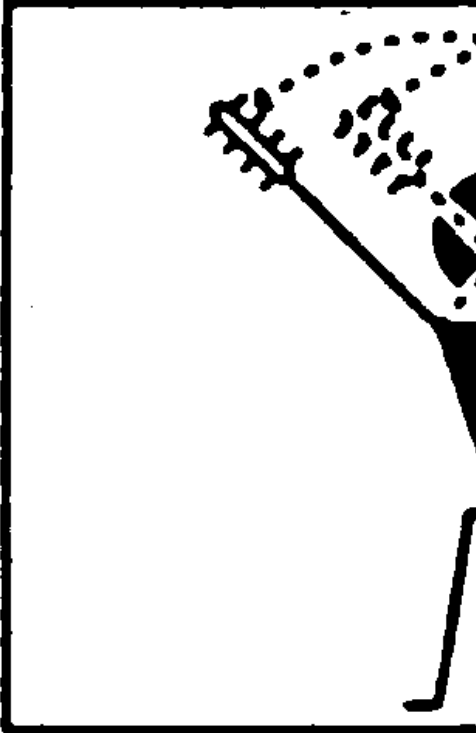
<i>Description of signal</i>	<i>Meaning of signal</i>	<i>In daylight</i>	<i>By night</i>
(e) (e) Arms repeatedly crossed above the head. The speed of arm movement indicates the urgency of the stop.	Arms Stop.		

Status: This is the original version (as it was originally made). This item of legislation is currently only available in its original format.

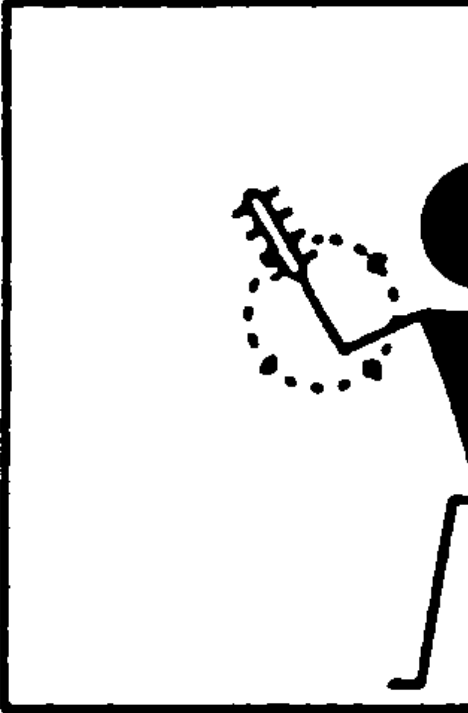
<i>Description of signal</i>	<i>Meaning of signal</i>	<i>In daylight</i>	<i>By night</i>
(f) (f) circular motion of the right hand at head level, with the left arm pointing to the appropriate engine.	A Start engine.		

Status: This is the original version (as it was originally made). This item of legislation is currently only available in its original format.

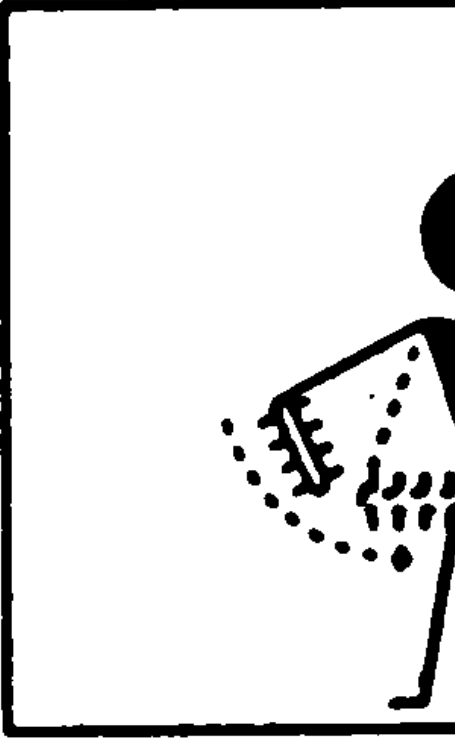

<i>Description of signal</i>	<i>Meaning of signal</i>	<i>In daylight</i>	<i>By night</i>
(g) (g) Arms extended, the palms facing inwards, then swung from the extended position inwards.	Chocks inserted.		

Status: This is the original version (as it was originally made). This item of legislation is currently only available in its original format.

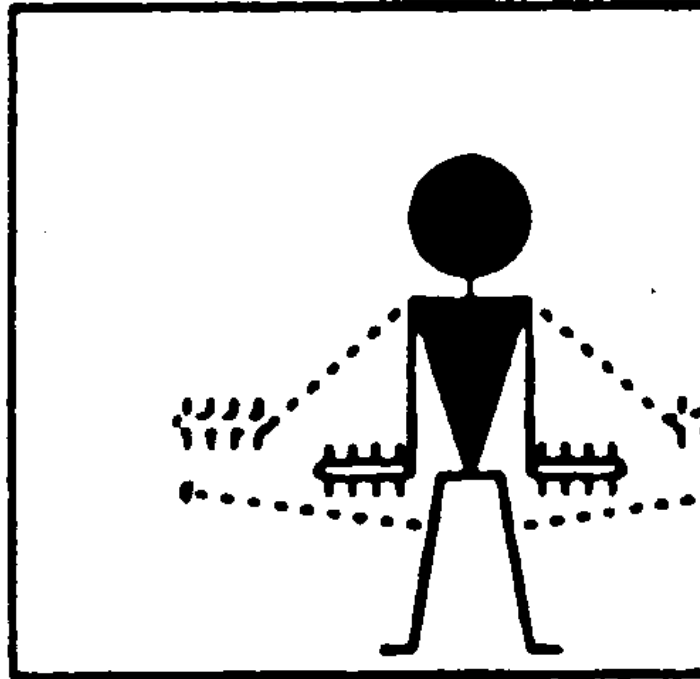
<i>Description of signal</i>	<i>Meaning of signal</i>	<i>In daylight</i>	<i>By night</i>
(h) (h)Chocks away.			

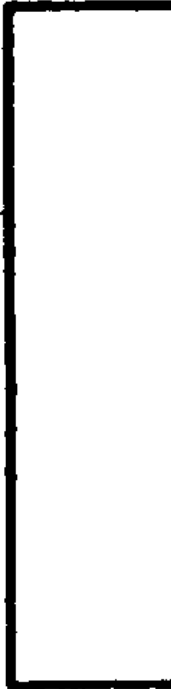

Status: This is the original version (as it was originally made). This item of legislation is currently only available in its original format.

<i>Description of signal</i>	<i>Meaning of signal</i>	<i>In daylight</i>	<i>By night</i>
(j) (j) Either arm and hand placed level with the chest, then moved laterally with the palm downwards.	Cut engines.		

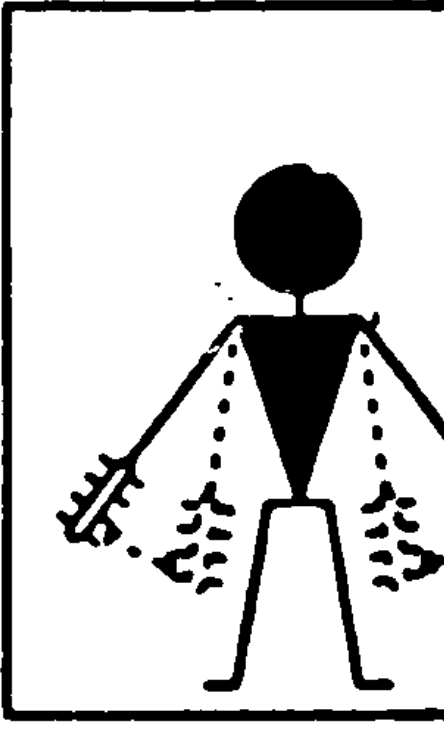

Status: This is the original version (as it was originally made). This item of legislation is currently only available in its original format.

<i>Description of signal</i>	<i>Meaning of signal</i>	<i>In daylight</i>	<i>By night</i>
(k) (k) Arms placed down, with the palms towards the ground, then moved up and down several times.	Slow down.		

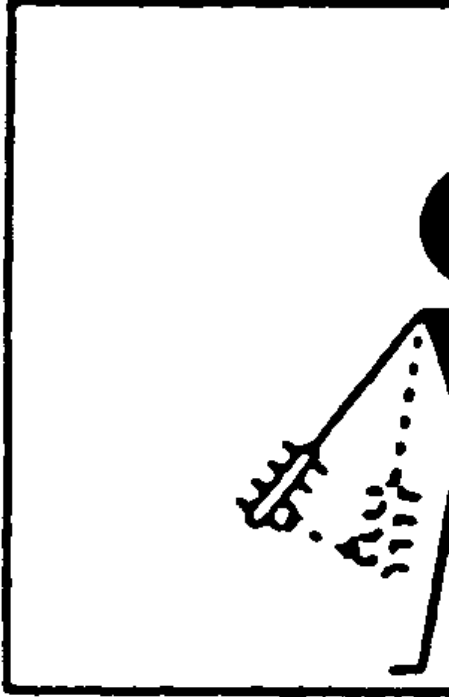
Status: This is the original version (as it was originally made). This item of legislation is currently only available in its original format.

<i>Description of signal</i>	<i>Meaning of signal</i>	<i>In daylight</i>	<i>By night</i>
<p>(1) (1) Arms placed down, with the palms towards the ground, then either the right or left arm moved up and down indicating that the motors on the left or right side, as the case may be, should be slowed down.</p>	<p>Slow down engines on indicated side.</p>		

Status: This is the original version (as it was originally made). This item of legislation is currently only available in its original format.

<i>Description of signal</i>	<i>Meaning of signal</i>	<i>In daylight</i>	<i>By night</i>
(m) (m) Arms placed above the head in a vertical position.	This bay.		

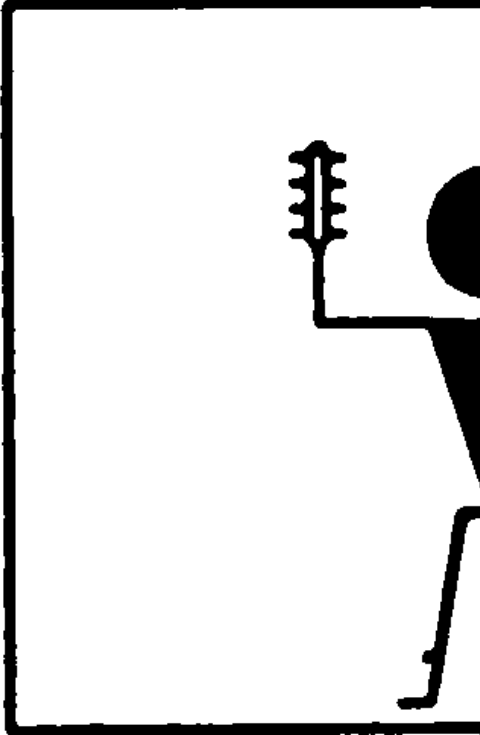

Status: This is the original version (as it was originally made). This item of legislation is currently only available in its original format.

<i>Description of signal</i>	<i>Meaning of signal</i>	<i>In daylight</i>	<i>By night</i>
(n) (n) The right arm raised at the elbow, with the arm facing forward.	All clear: marshalling finished.		

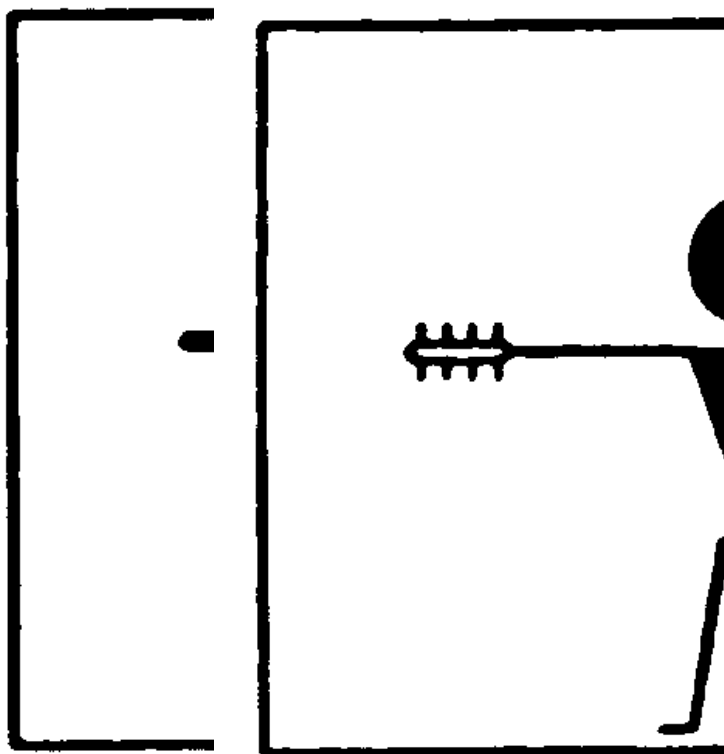
Status: This is the original version (as it was originally made). This item of legislation is currently only available in its original format.

<i>Description of signal</i>	<i>Meaning of signal</i>	<i>In daylight</i>	<i>By night</i>
(o) (o) Arms placed horizontally sideways.	Hover.		

Status: This is the original version (as it was originally made). This item of legislation is currently only available in its original format.

<i>Description of signal</i>	<i>Meaning of signal</i>	<i>In daylight</i>	<i>By night</i>
(p) (p) Arms placed down and crossed in front of the body.	Land.		

Status: This is the original version (as it was originally made). This item of legislation is currently only available in its original format.

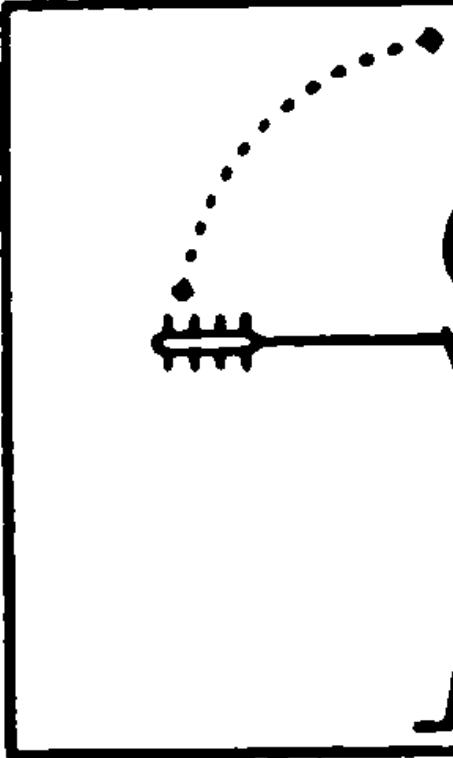
<i>Description of signal</i>	<i>Meaning of signal</i>	<i>In daylight</i>	<i>By night</i>
(q) (q) Arms placed horizontally sideways with the palms up beckoning upwards. The speed of arm movement indicates the rate of ascent.	Move upwards.		

Status: This is the original version (as it was originally made). This item of legislation is currently only available in its original format.

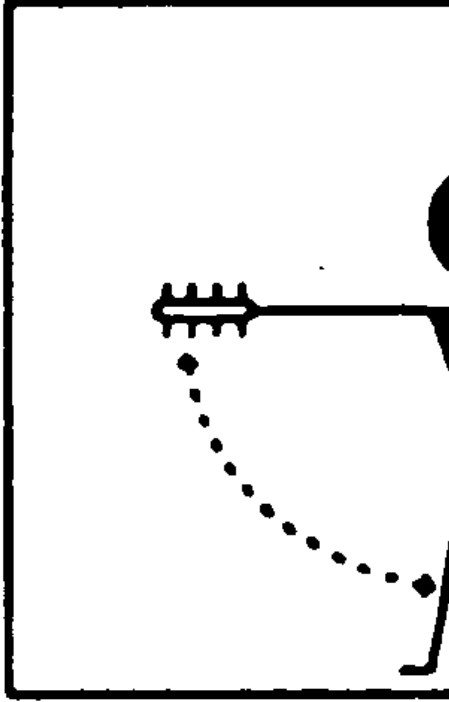
<i>Description of signal</i>	<i>Meaning of signal</i>	<i>In daylight</i>	<i>By night</i>
(r) (r) Arms placed horizontally sideways with the palms towards the ground beckoning downwards. The speed of arm movement indicates the rate of descent.	Move downwards.		

Status: This is the original version (as it was originally made). This item of legislation is currently only available in its original format.

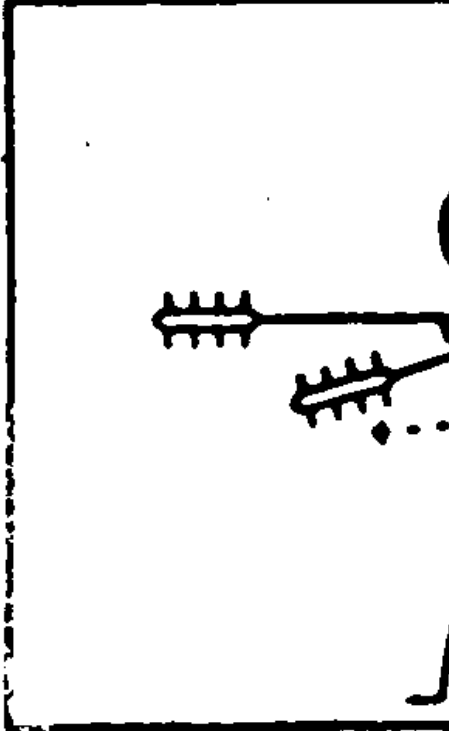
<i>Description of signal</i>	<i>Meaning of signal</i>	<i>In daylight</i>	<i>By night</i>
(s) (s) Either arm placed horizontally sideways, then the other arm moved in front of the body to that side, in the direction of the movement, indicating that the helicopter should move horizontally to the left or right side, as the case may be; repeated several times.	Move horizontally.		

Status: This is the original version (as it was originally made). This item of legislation is currently only available in its original format.

<i>Description of signal</i>	<i>Meaning of signal</i>	<i>In daylight</i>	<i>By night</i>
------------------------------	--------------------------	--------------------	-----------------

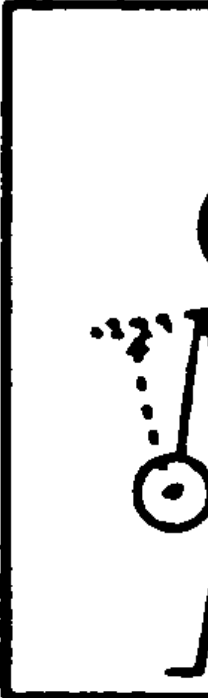
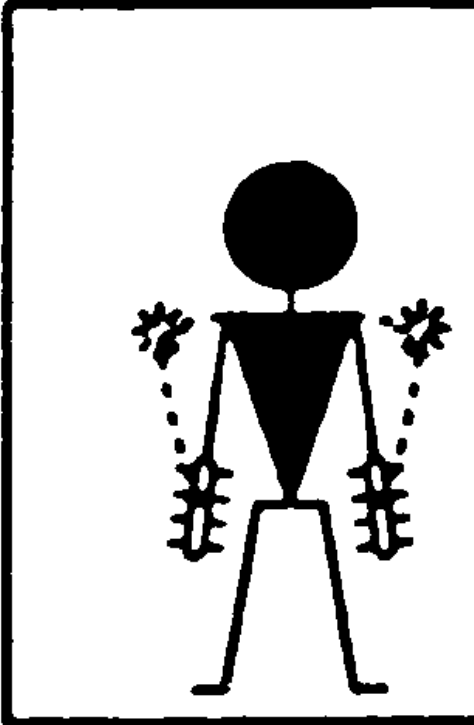

Status: This is the original version (as it was originally made). This item of legislation is currently only available in its original format.

<i>Description of signal</i>	<i>Meaning of signal</i>	<i>In daylight</i>	<i>By night</i>
(t) (t) Arms placed down, the palms facing forward, then repeatedly swept up and down to shoulder level.	Move back.		

Status: This is the original version (as it was originally made). This item of legislation is currently only available in its original format.

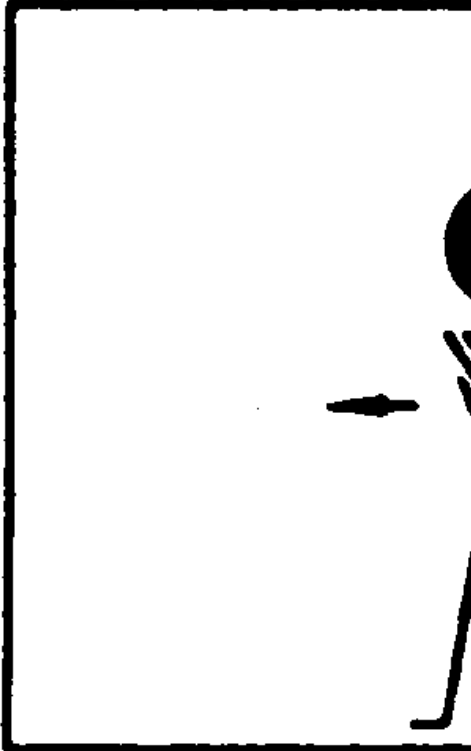
<i>Description of signal</i>	<i>Meaning of signal</i>	<i>In daylight</i>	<i>By night</i>
(u) (u) Left arm extended horizontally forward, then right arm making a horizontal slicing movement below left arm.	Release load.		

Status: This is the original version (as it was originally made). This item of legislation is currently only available in its original format.

<i>Description of signal</i>	<i>Meaning of signal</i>	<i>In daylight</i>	<i>By night</i>
(v) (v) Raise arm, with fist clenched, horizontally in front of body, then extend fingers.	Release Brakes.		Shall not be given at night.

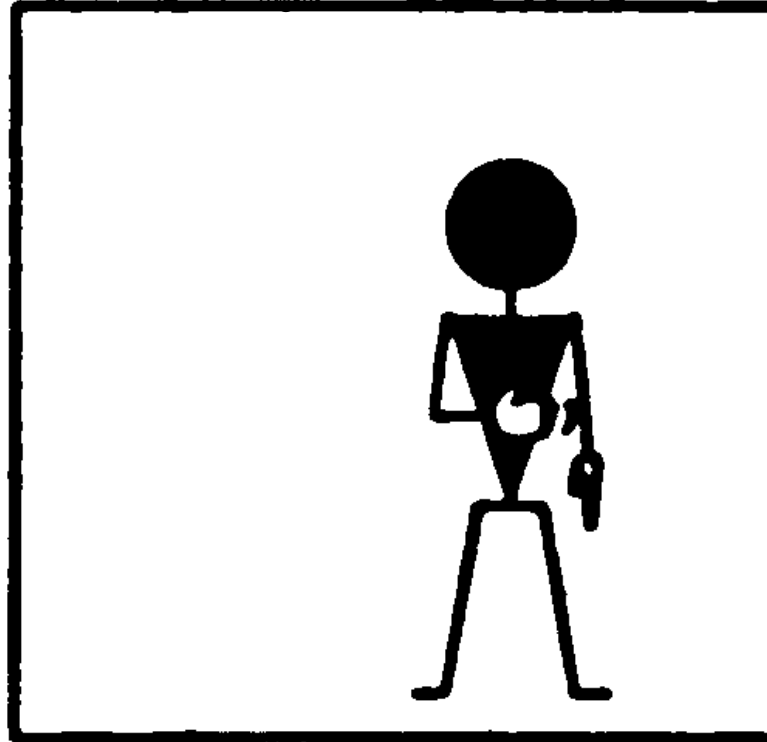

Status: This is the original version (as it was originally made). This item of legislation is currently only available in its original format.

<i>Description of signal</i>	<i>Meaning of signal</i>	<i>In daylight</i>	<i>By night</i>
Raise arm and hand, with fingers extended, horizontally in front of body, then clench fist.	Engage Brakes.		Shall not be given at night.

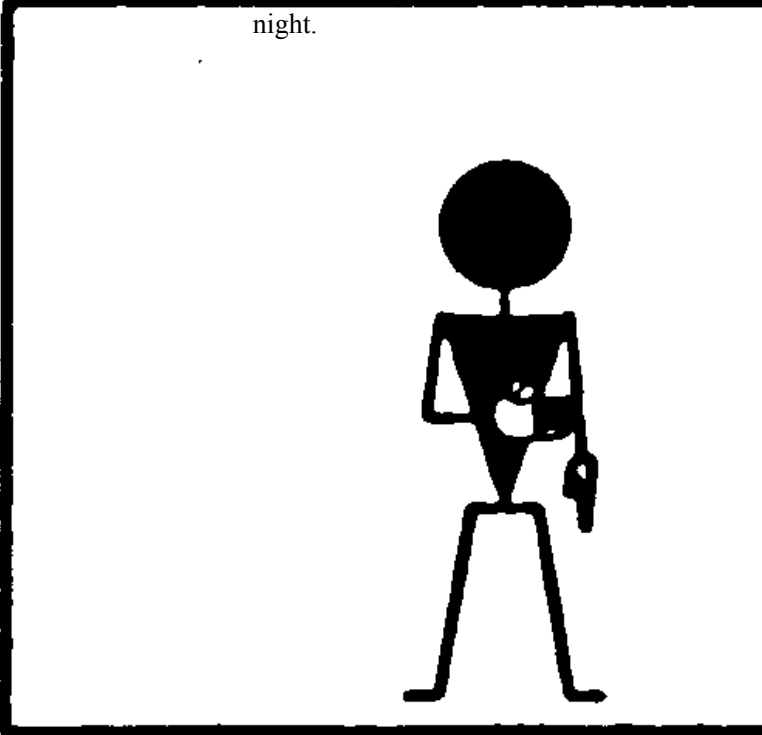

Status: This is the original version (as it was originally made). This item of legislation is currently only available in its original format.

<i>Description of signal</i>	<i>Meaning of signal</i>	<i>In daylight</i>	<i>By night</i>
(w) (w) Left hand overhead with the number of fingers extended, to indicate the number of the engine to be started, and circular motion of right hand at head level.	Start engine(s).		Shall not be given at night.

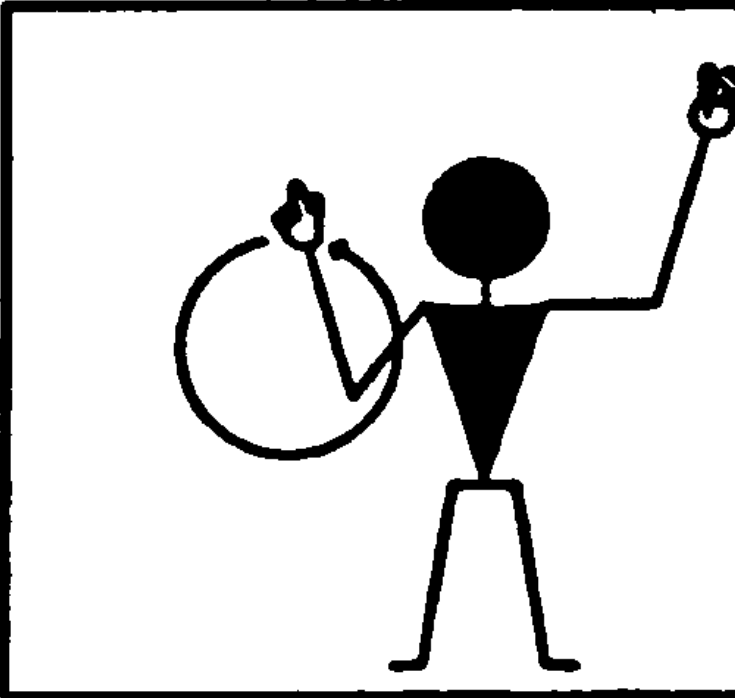

Status: This is the original version (as it was originally made). This item of legislation is currently only available in its original format.

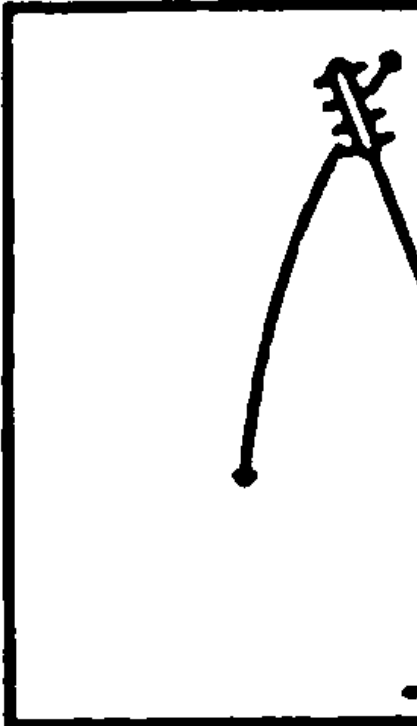
<i>Description of signal</i>	<i>Meaning of signal</i>	<i>In daylight</i>	<i>By night</i>
(x) (x) Point left arm down, move right arm down from overhead, vertical position to horizontal forward position, repeating right arm movement.	Back aircraft's tail to starboard.		

Status: This is the original version (as it was originally made). This item of legislation is currently only available in its original format.

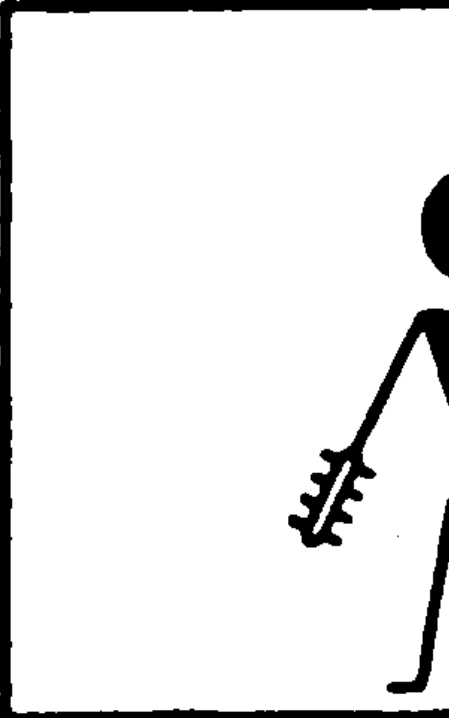
<i>Description of signal</i>	<i>Meaning of signal</i>	<i>In daylight</i>	<i>By night</i>
Point right arm down, move left arm down from overhead, vertical position to horizontal forward position, repeating left arm movement.	Back aircraft's tail to port.		

Marshalling signals (from a pilot of an aircraft to a marshaller)

48. The following signals made by a pilot in an aircraft to a marshaller on the ground shall respectively have the following meanings:

<i>Description of signal</i>	<i>Meaning of signal</i>
(a) (a) Raise arm and hand with fingers extended horizontally in front of face, then clench fist.	Brakes engaged.
(b) (b) Raise arm with fist clenched horizontally in front of face, then extend fingers.	Brakes released.
(c) (c) Arms extended palms facing outwards, move hands inwards to cross in front of face.	Insert chocks.
(d) (d) Hands crossed in front of face, palms facing outwards, move arms outwards.	Remove chocks.
(e) (e) Raise the number of fingers on one hand indicating the number of the engine to be started. For this purpose	Ready to start engines.

Status: This is the original version (as it was originally made). This item of legislation is currently only available in its original format.

<i>Description of signal</i>	<i>Meaning of signal</i>
the aircraft engines shall be numbered in relation to the marshaller facing the aircraft, from his right to his left, for example, No. 1 engine shall be the port outer engine, No. 2 engine shall be the port inner engine, No. 3 engine shall be the starboard inner engine and No. 4 engine shall be the starboard outer engine.	

Distress, urgency and safety signals

49.—(1) The following signals, given either together or separately before the sending of a message, signify that an aircraft is threatened by grave and imminent danger and requests immediate assistance:

- (a) by radiotelephony:
the spoken word “MAYDAY”;
- (b) by visual signalling:
 - (i) the signal SOS (... --- ...);
 - (ii) a succession of pyrotechnic lights fired at short intervals each showing a single red light;
 - (iii) a parachute flare showing a red light;
- (c) by sound signalling other than radiotelephony:
 - (i) the signal SOS (... --- ...);
 - (ii) a continuous sounding with any sound apparatus.

(2) The following signals, given either together or separately, before the sending of a message, signify that the commander of the aircraft wishes to give notice of difficulties which compel it to land but that he does not require immediate assistance:

- (a) a succession of white pyrotechnic lights;
- (b) the repeated switching on and off of the aircraft landing lights;
- (c) the repeated switching on and off of its navigation lights, in such a manner as to be clearly distinguishable from the flashing navigation lights described in rule 11.

(3) The following signals, given either together or separately, indicate that the commander of the aircraft has an urgent message to transmit concerning the safety of a ship, aircraft, vehicle or other property or of a person on board or within sight of the aircraft from which the signal is given:

- (a) by radiotelephony:
the repeated spoken word, “PAN PAN”;
- (b) by visual signalling:
the signal XXX (- .. --- .. --- .. -);
- (c) by sound signalling other than radiotelephony:
the signal XXX (- .. --- .. --- .. -).

SCHEDULE 14

Articles 10(3), 12(5), and (8), 15, 34(1),
35(4), 36(1), 47(1), 48(1), 108, 117(1) and
Schedule 5 paragraph 4(5)

AIR NAVIGATION (GENERAL) REGULATIONS

1. In these Regulations any reference to:
 - (a) a numbered article is a reference to the article in this Order so numbered;
 - (b) a numbered regulation is to the regulation in these Regulations so numbered;
 - (c) a numbered paragraph, or numbered or lettered sub-paragraph, is a reference to the paragraph or sub-paragraph so numbered or lettered in the regulation or paragraph, as the case may be, in which that reference appears;
 - (d) a numbered condition is a reference to the paragraph so numbered in the regulation or Annex, as the case may be, in which that reference appears.

Load Sheets

- 2.—(1) Every load sheet required by article 35(4) shall contain the following particulars—
 - (a) the nationality mark of the aircraft to which the load sheet relates, and the registration mark assigned to that aircraft by the Governor;
 - (b) particulars of the flight to which the load sheet relates;
 - (c) the total weight of the aircraft as loaded for that flight;
 - (d) the weights of the several items from which the total weight of the aircraft, as so loaded, has been calculated including in particular the weight of the aircraft prepared for service and the respective total weights of the crew (unless included in the weight of the aircraft prepared for service), passengers, baggage and cargo intended to be carried on the flight;
 - (e) the manner in which the load is distributed and the resulting position of the centre of gravity of the aircraft which may be given approximately if and to the extent that the relevant certificate of airworthiness so permits,

and shall include at the foot or end of the load sheet a certificate, signed by the person referred to in article 35(1) as responsible for the loading of the aircraft, that the aircraft has been loaded in accordance with the written instructions furnished to him by the operator of the aircraft pursuant to the said article 35(1).

- (a) (2) (a) Subject to sub-paragraph (b), for the purpose of calculating the total weight of the aircraft the respective total weights of the passengers and crew together with their hand baggage entered in the load sheet shall be computed from the actual weight of each person and their hand baggage and for that purpose each person and their hand baggage shall be separately weighed:
- (b) Sub-paragraph (a) shall be deemed to be complied with if, subject to the provisions of paragraph (4), the total weights of the passengers and crew together with their hand baggage are calculated at not less than the appropriate weights shown in Tables 1 or 2 and the load sheet bears a notation to that effect.

Status: This is the original version (as it was originally made). This item of legislation is currently only available in its original format.

TABLE 1

	<i>Passenger seats available</i>		
	<i>20 or more Male</i>	<i>Female</i>	<i>30 or more all adult</i>
Passengers on all flights except holiday charters	88 kg	70 kg	84 kg
Passengers on holiday charters	83 kg	69 kg	76 kg
Children (between 2–12 years) or infants under 2 years of age if occupying a separate seat	35 kg	35 kg	
Infants under 2 years of age if sharing a seat with an adult	0 kg	0 kg	
Flight crew	85 kg	85 kg	
Cabin crew	75 kg	75 kg	

- (c) Where the total number of passenger seats available on an aircraft is 20 or more, the weights for males and females in Table 1 are applicable. As an alternative, where the total number of passenger seats available is 30 or more, the all adult weights in Table 1 may be used for passengers over the age of 12 years.
- (d) For the purpose of Table 1, “holiday charter” means a flight by an aircraft for the carriage of passengers each of whom is carried pursuant to an agreement which provides for carriage by air to a place outside the Territory and back from that place, or from another place, to the Territory (whether or not on the same aircraft) and for accommodation at a place outside the Territory.
- (e) Where the total number of passenger seats available on an aircraft is 19 or less the weights in Table 2 are applicable.

TABLE 2

	<i>Passenger seats available</i>		
	<i>1–5</i>	<i>6–9</i>	<i>10–19</i>
Male passengers	104 kg	96 kg	92 kg
Female passengers	86 kg	78 kg	74 kg
Children (between 2–12 years) or infants under 2 years of age if occupying a separate seat	35 kg	35 kg	35 kg

Status: This is the original version (as it was originally made). This item of legislation is currently only available in its original format.

	<i>Passenger seats available</i>		
	<i>1–5</i>	<i>6–9</i>	<i>10–19</i>
Infants under 2 years of age if sharing a seat with an adult	0 kg	0 kg	0 kg
Flight crew	85 kg	85 kg	85 kg
Cabin crew	75 kg	75 kg	75 kg

- (f) On flights where no hand baggage is carried or where such hand baggage is accounted for separately, 6 kg may be deducted from the weight of passengers over 12 years of age when using Table 2.
- (g) Where any immersion suit is worn or carried by a passenger or crew member, 3 kg shall be added to the appropriate weight shown in Table 1 or 2 in each such case.
- (a) (3) (a) Subject to sub-paragraph (b), for the purpose of calculating the total weight of the aircraft the respective total weights of the hold baggage and cargo entered in the load sheet shall be computed from the actual weight of each piece of baggage, cargo or cargo container and for that purpose each piece or container shall be separately weighed.
- (b) Sub-paragraph (a) shall be deemed to be complied with in the case of an aircraft where the total number of passenger seats available is 20 or more, if, subject to the provisions of paragraph (4), the total weights of the hold baggage are calculated at not less than the weights shown in Table 3 and the load sheet bears a notation to that effect—

TABLE 3

<i>Journey made by aircraft</i>	<i>Hold baggage per piece</i>
Domestic	11 kg
European	13 kg
Intercontinental	15 kg

- (c) For the purposes of this paragraph:
 - (i) A journey made by an aircraft shall be treated as domestic if it is confined within such an area as may be prescribed.
 - (ii) A journey made by an aircraft, not being a domestic journey, shall be treated as European if it is confined within an area enclosed by rhumb lines joining successively the following points—

N7200.00	E04500.00	N4000.00	E04500.00
N3500.00	E03700.00	N3000.00	E03700.00
N3000.00	W00600.00	N2700.00	W00900.00
N2700.00	W03000.00	N6700.00	W03000.00
N7200.00	W01000.00	N7200.00	E04500.00

- (iii) A journey made by an aircraft shall be treated as intercontinental if it is neither domestic nor European.
- (a) (4) (a) If it appears to the person supervising the loading of the aircraft that:
 - (i) any person and his hand baggage to be carried exceeds the weights set out in Tables 1 or 2;

Status: This is the original version (as it was originally made). This item of legislation is currently only available in its original format.

- (ii) where paragraph (2)(f) applies, any passenger to be carried exceeds the weights set out in Table 2 as adjusted in accordance with that paragraph; or
- (iii) any hold baggage to be carried exceeds the weights set out in Table 3:

he shall, if he considers it necessary in the interests of the safety of the aircraft, or if the Governor has so directed in the particular case, require any such person and his hand baggage, passenger or hold baggage, as the case may be, to be weighed for the purpose of the entry to be made in the load sheet.

- (b) If any person and his hand baggage, passenger or any hold baggage has been weighed pursuant to sub-paragraph (a), the weights entered in the load sheet shall take account of the actual weight of that person and his hand baggage, that passenger or that hold baggage, as the case may be, or of the weight determined in accordance with the sub-paragraphs (2) (b) or (3)(b) whichever weight shall be the greater.

Weight and performance: general provisions

3.—(1) The assessment of the ability of an aeroplane to comply with the requirements of regulations 4 to 10 inclusive and of a helicopter to comply with the requirements of regulations 11 to 13 inclusive (relating in either case to weight, performance and flights in specified meteorological conditions or at night) shall be based on the specified information as to its performance, or, in the case of an aeroplane in respect of which there is in force under this Order a certificate of airworthiness which does not include a performance group classification, the assessment may be based on the best information available to the commander of the aircraft, insofar as the relevant information is not specified.

(2) In assessing the ability of an aeroplane to comply with condition (7) in the Annex hereto, conditions (4) and (5) of regulation 5, and sub-paragraphs (a)(ii) and (b) of condition (2) in regulation 10, account may be taken of any reduction of the weight of the aeroplane which may be achieved after the failure of a power unit by such jettisoning of fuel as is feasible and prudent in the circumstances of the flight and in accordance with the flight manual included in the certificate of airworthiness relating to the aircraft.

(3) In regulations 3 to 13, and in the Annex hereto, unless the context otherwise requires—

“specified” in relation to an aircraft means specified in, or ascertainable by reference to—

- (a) the certificate of airworthiness in force under this Order in respect of that aircraft; or
- (b) the flight manual or performance schedule included in that certificate, or other document, whatever its title, incorporated by reference in that certificate;

“the emergency distance available” means the distance from the point on the surface of the aerodrome at which the aeroplane can commence its take off run to the nearest point in the direction of take off at which the aeroplane cannot roll over the surface of the aerodrome and be brought to rest in an emergency without the risk of accident;

“the landing distance available” means the distance from the point on the surface of the aerodrome above which the aeroplane can commence its landing, having regard to the obstructions in its approach path, to the nearest point in the direction of landing at which the surface of the aerodrome is incapable of bearing the weight of the aeroplane under normal operating conditions or at which there is an obstacle capable of affecting the safety of the aeroplane;

“the take off distance available” means either the distance from the point on the surface of the aerodrome at which the aeroplane can commence its take off run to the nearest obstacle in the direction of take off projecting above the surface of the aerodrome and capable of affecting the safety of the aeroplane, or one and one half times the take off run available, whichever is the less;

Status: This is the original version (as it was originally made). This item of legislation is currently only available in its original format.

“the take off run available” means the distance from the point on the surface of the aerodrome at which the aeroplane can commence its take off run to the nearest point in the direction of take off at which the surface of the aerodrome is incapable of bearing the weight of the aeroplane under normal operating conditions.

- (4) For the purposes of regulations 3 to 13 inclusive and of the Annex hereto—
- (a) the weight of the aircraft at the commencement of the take off run or of the take off shall be taken to be its gross weight including everything and everyone carried in or on it at the commencement of the take off run or of the take off;
 - (b) the landing weight of the aircraft shall be taken to be the weight of the aircraft at the estimated time of landing allowing for the weight of the fuel and oil expected to be used on the flight to the aerodrome at which it is intended to land or alternate aerodrome, as the case may be;
 - (c) where any distance referred to in paragraph (3) has been declared in respect of any aerodrome by the authority responsible for regulating air navigation over the territory of the Contracting State in which the aerodrome is situated, and in the case of an aerodrome in the Territory, notified, that distance shall be deemed to be the relevant distance.
- (5) Nothing in regulations 3 to 13 inclusive, shall apply to any aircraft flying solely for the purpose of training persons to perform duties in aircraft.

Weight and performance of public transport aeroplanes having no performance group classification in their certificates of airworthiness

4. For the purposes of article 36(1), an aeroplane registered in the Territory, in respect of which there is in force under this Order a certificate of airworthiness which does not include a performance group classification, shall not fly for the purpose of public transport unless the weight of aeroplane at the commencement of the take off run is such that such of the conditions in the Annex hereto as apply to that aircraft are satisfied.

Weight and performance of public transport aeroplanes classified as aeroplanes of performance group A or performance group B in their certificates of airworthiness

5. For the purposes of article 36(1), an aeroplane registered in the Territory in respect of which there is in force under this Order a certificate of airworthiness in which the aeroplane is designated as being of performance group A or performance group B shall not fly for the purpose of public transport unless the weight of the aeroplane at the commencement of the take off run is such that the following conditions are satisfied—

- (1) That weight does not exceed the maximum take off weight specified for the altitude and the air temperature at the aerodrome at which the take off is to be made.
- (2) The take off run, take off distance and the emergency distance respectively required for take off, specified as being appropriate to—
 - (a) the weight of the aeroplane at the commencement of the take off run;
 - (b) the altitude at the aerodrome;
 - (c) the air temperature at the aerodrome;
 - (d) the condition of the surface of the runway from which the take off will be made;
 - (e) the slope of the surface of the aerodrome in the direction of take off over the take off run available, the take off distance available and the emergency distance available, respectively; and

Status: This is the original version (as it was originally made). This item of legislation is currently only available in its original format.

- (f) not more than 50 per cent. of the reported wind component opposite to the direction of take off or not less than 150 per cent. of the reported wind component in the direction of take off,

do not exceed the take off run, the take off distance and the emergency distance available, respectively, at the aerodrome at which the take off is to be made; in ascertaining the emergency distance required, the point at which the pilot is assumed to decide to discontinue the take off shall not be nearer to the start of the take off run than the point at which, in ascertaining the take off run required and the take off distance required, he is assumed to decide to continue the take off, in the event of power unit failure.

- (a) (3) (a) The net take off flight path with one power unit inoperative, specified as being appropriate to—
- (i) the weight of the aeroplane at the commencement of the take off run;
 - (ii) the altitude at the aerodrome;
 - (iii) the air temperature at the aerodrome; and
 - (iv) not more than 50 per cent. of the reported wind component opposite to the direction of take off or not less than 150 per cent. of the reported wind component in the direction of take off,

and plotted from a point 35 feet or 50 feet, as appropriate, above the end of the take off distance required at the aerodrome at which the take off is to be made to a height of 1,500 feet above the aerodrome, shows that the aeroplane will clear any obstacle in its path by a vertical interval of at least 35 feet; and if it is intended that the aeroplane shall change its direction of flight by more than 15° before reaching 1,500 feet the vertical interval shall not be less than 50 feet during the change of direction.

- (b) For the purpose of sub-paragraph (a) an obstacle shall be deemed to be in the path of the aeroplane if the distance from the obstacle to the nearest point on the ground below the intended line of flight of the aeroplane does not exceed—
- (i) a distance of 60 metres plus half the wing span of the aeroplane plus one eighth of the distance from such point to the end of the take off distance available measured along the intended line of flight of the aeroplane; or
 - (ii) 900 metres,

whichever is the less.

- (c) In assessing the ability of the aeroplane to satisfy the condition, it shall not be assumed to make a change of direction of a radius less than the specified radius of steady turn.
- (a) (4) (a) Subject to sub-paragraph (b), the aeroplane will, in the meteorological conditions expected for the flight in the event of any one power unit becoming inoperative at any point on its route or on any planned diversion therefrom and with the other power unit or units operating within the maximum continuous power conditions specified, be capable of continuing the flight, clearing by a vertical interval of at least 2,000 feet obstacles within 10 nautical miles either side of the intended track, to an aerodrome at which it can comply with condition (7) relating to an alternate aerodrome, and on arrival over such aerodrome the gradient of the specified net flight path with one power unit inoperative shall not be less than zero at 1,500 feet above the aerodrome; and in assessing the ability of the aeroplane to satisfy this condition it shall not be assumed to be capable of flying at an altitude exceeding the specified maximum permissible altitude for power unit restarting.
- (b) Where the operator of the aeroplane is satisfied, taking into account the navigation aids which can be made use of by the aeroplane on the route, that the commander of the aeroplane will be able to maintain his intended track on that route within a margin of

Status: This is the original version (as it was originally made). This item of legislation is currently only available in its original format.

five nautical miles, the foregoing provisions of this paragraph shall have effect as if five nautical miles were substituted for 10 nautical miles.

- (a) (5) (a) Subject to sub-paragraph (b), in the case of an aeroplane having three or more power units, it will, in the meteorological conditions expected for the flight, in the event of any two power units becoming inoperative at any point along the route or on any planned diversion therefrom more than 90 minutes flying time in still air at the all power units operating economical cruise speed from the nearest aerodrome at which it can comply with condition (7), relating to an alternate aerodrome, be capable of continuing the flight with all other power units operating within the specified maximum continuous power conditions, clearing by a vertical interval of at least 2,000 feet obstacles within 10 nautical miles either side of the intended track to such an aerodrome, and on arrival over such an aerodrome the gradient of the specified net flight path with two power units inoperative shall not be less than zero at 1,500 feet above the aerodrome; and in assessing the ability of the aeroplane to satisfy this condition it shall not be assumed to be capable of flying at an altitude exceeding the specified maximum permissible altitude for power unit restarting.
 - (b) Where the operator of the aeroplane is satisfied, taking into account the navigation aids which can be made use of by the aeroplane on the route, that the commander of the aeroplane will be able to maintain his intended track on that route within a margin of five nautical miles, the foregoing provisions of this paragraph shall have effect as if five nautical miles were substituted for 10 nautical miles; or
 - (c) In the case of an aeroplane having two power units and a maximum total weight authorised which exceeds 5,700kg and which is not limited by its certificate of airworthiness to the carriage of less than 20 passengers, it will, in the meteorological conditions expected for the flight, at any point along the route or on any planned diversion therefrom, not be more than 60 minutes flying time at the normal one engine inoperative cruise speed in still air from the nearest aerodrome at which it can comply with condition (7), relating to an alternate aerodrome, unless it is flying under and in accordance with the terms of any written permission granted by the Governor to the operator under this regulation; or
 - (d) In the case of an aeroplane having two power units and a maximum total weight authorised of 5,700 kg or less or in the case of an aeroplane having two power units and a maximum total weight authorised of more than 5,700 kg but which is limited by its certificate of airworthiness to the carriage of less than 20 passengers the aeroplane will, in the meteorological conditions expected for the flight, not be more than 90 minutes flying time in still air at the all power units operating economical cruise speed from the nearest aerodrome at which it can comply with condition (7), relating to an alternate aerodrome.
- (6) The landing weight of the aeroplane will not exceed the maximum landing weight specified for the altitude and the expected air temperature for the estimated time of landing at the aerodrome at which it is intended to land and at any alternate aerodrome.
- (a) (7) (a) Subject to sub-paragraph (b),
 - (i) In the case of a turbine-jet powered aeroplane, the landing distance required does not exceed at the aerodrome at which it is intended to land or at any alternate aerodrome, as the case may be, the landing distance available on:
 - (aa) the most suitable runway for a landing in still air conditions, and
 - (bb) the runway that may be required for landing because of the forecast wind conditions.
 - (ii) In the case of an aeroplane powered by turbine propeller or piston engines, the landing distances required, respectively specified as being appropriate to aerodromes of destination and alternate aerodromes, do not exceed at the aerodrome at which it

Status: This is the original version (as it was originally made). This item of legislation is currently only available in its original format.

is intended to land or at any alternate aerodrome, as the case may be, the landing distance available on—

- (aa) the most suitable runway for a landing in still air conditions, and
 - (bb) the runway that may be required for landing because of the forecast wind conditions.
- (b) If an alternate aerodrome is designated in the flight plan, the specified landing distance required may be that appropriate to an alternate aerodrome when assessing the ability of the aeroplane to satisfy this condition at the aerodrome of destination.
- (c) For the purposes of sub-paragraph (a) the landing distance required shall be that specified as being appropriate to—
- (i) the landing weight;
 - (ii) the altitude of the aerodrome;
 - (iii) the temperature in the specified international standard atmosphere appropriate to the altitude at the aerodrome;
 - (iv) (aa) a level surface in the case of runways usable in both directions; or
(bb) the average slope of the runway in the case of runways usable in only one direction; and
 - (v) (aa) still air conditions in the case of the most suitable runway for a landing in still air conditions; and
(bb) not more than 50 per cent. of the forecast wind component opposite to the direction of landing or not less than 150 per cent. of the forecast wind component in the direction of landing in the case of the runway that may be required for landing because of the forecast wind conditions.

Weight and performance of public transport aeroplanes classified as aeroplanes of performance group C in their certificates of airworthiness

6. For the purposes of article 36(1), an aeroplane registered in the Territory in respect of which there is in force under this Order a certificate of airworthiness in which the aeroplane is designated as being of performance group C shall not fly for the purpose of public transport unless the weight of the aeroplane at the commencement of the take off run is such that the following conditions are satisfied—

(1) That weight does not exceed the maximum take off weight specified for the altitude and the air temperature at the aerodrome at which the take off is to be made.

(2) The take off run required and the take off distance required, specified as being appropriate to:—

- (a) the weight of the aeroplane at the commencement of the take off run;
 - (b) the altitude at the aerodrome;
 - (c) the air temperature at the aerodrome;
 - (d) the average slope of the surface of the aerodrome in the direction of take off over the emergency distance available; and
 - (e) not more than 50 per cent. of the reported wind component opposite to the direction of take off or not less than 150 per cent. of the reported wind component in the direction of take off, do not exceed the take off run available and the emergency distance available, respectively, at the aerodrome at which the take off is to be made.
- (a) (3) (a) Subject to condition (4), the net take off flight path with all power units operating specified as being appropriate to—

Status: This is the original version (as it was originally made). This item of legislation is currently only available in its original format.

- (i) the weight of the aeroplane at the commencement of the take off run;
- (ii) the altitude of the aerodrome;
- (iii) the air temperature at the aerodrome; and
- (iv) not more than 50 per cent. of the reported wind component opposite to the direction of the take off or not less than 150 per cent. of the reported wind component in the direction of take off;

and plotted from a point 50 feet above the end of the take off distance required at the aerodrome at which the take off is to be made to a height of 1,500 feet above the aerodrome shows that the aeroplane will clear any obstacle in its path by a vertical interval of not less than 35 feet; and if it is intended that the aeroplane shall change its direction of flight by more than 15° before reaching 1,500 feet the vertical interval shall be not less than 50 feet during the change of direction.

- (b) For the purpose of sub-paragraph (a) an obstacle shall be deemed to be in the path of the aeroplane if the distance from the obstacle to the nearest point on the ground below the intended line of flight of the aeroplane does not exceed 75 metres.
- (c) In assessing the ability of the aeroplane to satisfy this condition, it shall not be assumed to make a change of direction of a radius less than the specified radius of steady turn.
- (a) (4) (a) In the case of an aeroplane which is intended to be flown for any period before reaching a height of 1,500 feet above the aerodrome from which the take off is to be made in conditions which will not ensure that any obstacles can be located by means of visual observation, the net take off flight path with one power unit inoperative specified as being appropriate to the factors contained in sub-paragraphs (a)(i) to (iv) of condition (3), and plotted from the point of the net take off flight path with all power units operating specified as being appropriate to those factors at which in the meteorological conditions expected for the flight the loss of visual reference would occur, shows that the aeroplane will clear by a vertical interval of not less than 35 feet any obstacle in its path; and if it is intended that the aeroplane shall change its direction of flight by more than 15° before reaching 1,500 feet the vertical interval shall not be less than 50 feet during the change of direction.
- (b) For the purpose of sub-paragraph (a) an obstacle shall be deemed to be in the path of the aeroplane if the distance from the obstacle to the nearest point on the ground below the intended line of flight of the aeroplane does not exceed—
 - (i) 75 metre plus one-eighth of the distance from such point to the end of the emergency distance available measured along the intended line of flight of the aeroplane; or
 - (ii) 900 metres,whichever is the less.
- (c) In assessing the ability of the aeroplane to satisfy this condition it shall not be assumed to make a change of direction of a radius of less than the specified radius of steady turn.

(5) The aeroplane at any time after it reaches a height of 1,500 feet above the aerodrome from which the take off is made will, in the meteorological conditions expected for the flight, in the event of any one power unit becoming inoperative at any point on its route or on any planned diversion therefrom, and with the other power unit or power units operating within the specified maximum continuous power conditions, be capable of continuing the flight at altitudes not less than the relevant minimum altitude for safe flight stated in, or calculated from the information contained in, the operations manual relating to the aeroplane to a point 1,500 feet above an aerodrome at which a safe landing can be made and after arrival at that point be capable of maintaining that height: in assessing the ability of the aeroplane to satisfy this condition it shall not be assumed to be capable of flying at any point on its route at an altitude exceeding the performance ceiling, with all power units operating, specified as being appropriate to its estimated weight at that point.

Status: This is the original version (as it was originally made). This item of legislation is currently only available in its original format.

(6) The landing weight of the aeroplane will not exceed the maximum landing weight specified for the altitude and the expected air temperature for the estimated time of landing at the aerodrome at which it is intended to land and at any alternate aerodrome.

(7) Subject to condition (8), the distance required by the aeroplane to land from a height of 50 feet otherwise than in accordance with specified data for short field landing does not, at the aerodrome at which it is intended to land and at any alternate aerodrome, exceed 70 per cent. of the landing distance available on the most suitable runway for a landing in still air conditions, and on the runway that may be required for landing because of the forecast wind conditions; and for the purposes of this condition the distance required to land from a height of 50 feet shall be taken to be that specified as being appropriate to:

- (a) the landing weight;
- (b) the altitude at the aerodrome;
- (c) the temperature in the specified international standard atmosphere appropriate to the altitude at the aerodrome;
- (d) (i) the level surface in the case of runways usable in both directions; or
(ii) the average slope of the runway in the case of runways usable in only one direction; and
- (e) (i) still air conditions in the case of the most suitable runway for landing in still air conditions; and
(ii) not more than 50 per cent. of the forecast wind component opposite to the direction of landing or not less than 150 per cent. of the forecast wind component in the direction of landing in the case of the runway that may be required for landing because of the forecast wind conditions.

- (a) (8) (a) Subject to sub-paragraph (b), as an alternative to condition (7), the distance required by the aeroplane, with all power units operating or with one power unit inoperative, to land in accordance with specified data for short field landing, does not at the aerodrome of intended destination and at any alternate aerodrome exceed the landing distance available and on the runway that may be required for landing because of the forecast wind conditions; and for the purposes of this condition the distance required to land from the appropriate height shall be taken to be that specified as being appropriate to the factors set forth in such-paragraphs (a) to (e) or condition (7) and the appropriate height shall be

- (i) for a landing with all power units operating-any height between 30 and 50 feet in the Territory, and 50 feet elsewhere; and
- (ii) for a landing with one power unit inoperative-50 feet in the Territory and elsewhere.
- (b) (i) If the specified distance required to land with one power unit inoperative from a height of 50 feet at the aerodrome of intended destination exceeds the landing distance available, it shall be sufficient compliance with sub-paragraph (ii) if an alternate aerodrome which has available the specified landing distance required to land with one power unit inoperative from such a height, is designated in the flight plan; and
(ii) the distance required by the aeroplane to land shall be determined in accordance with condition (7) and not in accordance with this condition if it is intended to land at night, or when the cloud ceiling or ground visibility forecast for the estimated time of landing at the aerodrome of intended destination and at any alternate aerodrome at which it is intended to land in accordance with specified data for short field landing with all power units operating, are less than 500 feet and one nautical mile respectively.

Weight and performance of public transport aeroplanes classified as aeroplanes of performance group D in their certificates of airworthiness

7. For the purposes of article 36(1), an aeroplane registered in the Territory in respect of which there is in force under this Order a certificate of airworthiness in which the aeroplane is designated as being of performance group D shall not fly for the purpose of public transport at night or when the cloud ceiling or visibility prevailing at the aerodrome of departure and forecast for the estimated time of landing at the aerodrome at which it is intended to land and at any alternate aerodrome are less than 1,000 feet and one nautical mile respectively, and shall not fly for the purpose of public transport at any other time unless the weight of the aeroplane at the commencement of the take off run is such that the following conditions are satisfied:

(1) That weight does not exceed the maximum take off weight specified for the altitude and air temperature at the aerodrome at which the take off is to be made.

(2) The take off run required and the take off distance required specified as being appropriate to:

- (a) the weight of the aeroplane at the commencement of the take off run;
- (b) the altitude of the aerodrome;
- (c) the air temperature at the aerodrome;
- (d) the average slope of the surface of the aerodrome in the direction of take off over the emergency distance available; and
- (e) not more than 50 per cent. of the reported wind component opposite to the direction of take off or not less than 150 per cent. of the reported wind component in the direction of take off,

do not exceed the take off run available and the emergency distance available, respectively, at the aerodrome at which the take off is to be made.

(a) (3) (a) The net take off flight path with all power units operating, specified as being appropriate to:

- (i) the weight of the aeroplane at the commencement of the take off run;
- (ii) the altitude at the aerodrome;
- (iii) the air temperature at the aerodrome; and
- (iv) not more than 50 per cent. of the reported wind component opposite to the direction of take off or not less than 150 per cent. of the reported wind component in the direction of take off,

and plotted from a point of 50 feet above the end of the take off distance required at the aerodrome at which the take off is to be made to the point at which the aeroplane reaches a height of 1,000 feet above the aerodrome shows that the aeroplane will clear any obstacle in its path by a vertical interval of not less than 35 feet, except that if it is intended that the aeroplane shall change its direction of flight by more than 15° before reaching 1,000 feet the vertical interval shall be not less than 50 feet during the change of direction.

(b) For the purpose of sub-paragraph (a) an obstacle shall be deemed to be in the path of the aeroplane if the distance from the obstacle to the nearest point on the ground below the intended line of flight of the aeroplane does not exceed 75 metres.

(c) In assessing the ability of the aeroplane to satisfy this condition it shall not be assumed to make a change of direction of a radius less than the specified radius of steady turn.

(4) The aeroplane, at any time after it reaches a height of 1,000 feet above the aerodrome from which the take off is to be made, will, in the meteorological conditions expected for the flight, in the event of any one power unit becoming inoperative at any point on its route or on any planned diversion therefrom, and with the other power unit or power units, if any, operating within the

Status: This is the original version (as it was originally made). This item of legislation is currently only available in its original format.

maximum specified continuous power conditions, be capable of continuing the flight at altitudes of not less than the relevant minimum altitudes for safe flight stated in, or calculated from the information contained in, the operations manual relating to the aeroplane to a point 1,000 feet above a place at which a safe landing can be made: in assessing the ability of the aeroplane to satisfy this condition it shall not be assumed to be capable of flying at any point on its route at an altitude exceeding the performance ceiling with all power units operating specified as being appropriate to its estimated weight at that point.

(5) The landing weight of the aeroplane will not exceed the maximum landing weight specified for the altitude and the expected air temperature for the estimated time of landing at the aerodrome at which it is intended to land and at any alternate aerodrome.

(6) The distance required by the aeroplane to land from a height of 50 feet does not, at the aerodrome at which it is intended to land and at any alternate aerodrome, exceed 70 per cent. of the landing distance available on the most suitable runway for a landing in still air conditions, and on the runway that may be required for landing because of the forecast wind conditions; and for the purposes of the runway that may be required for this condition the distance required to land from a height of 50 feet shall be taken to be that specified as being appropriate to:—

- (a) the landing weight;
- (b) the altitude at the aerodrome;
- (c) the temperature in the specified international standard atmosphere appropriate to the altitude at the aerodrome;
- (d) (i) a level surface in the case of runways usable in both directions; or
(ii) the average slope of the runway in the case of runways usable in only one direction; and
- (e) (i) still air conditions in the case of the most suitable runway for a landing in still air conditions; and
(ii) not more than 50 per cent. of the forecast wind component opposite to the direction of landing or not less than 150 per cent. of the forecast wind component in the direction of landing in the case of the runway that may be required for the landing because of the forecast wind conditions.

Weight and performance of public transport aeroplanes classified as aeroplanes of performance group E in their certificates of airworthiness

8.—(1) For the purposes of article 36(1), an aeroplane registered in the Territory in respect of which there is in force under this Order a certificate of airworthiness in which the aeroplane is designated as being of performance group E shall not fly for the purpose of public transport unless the weight of the aeroplane at the commencement of the take off run is such that the following conditions are satisfied:

- (a) That weight for the altitude and the air temperature at the aerodrome at which the take off is to be made does not exceed the maximum take off weight specified as being appropriate to:
 - (i) the weight at which the aeroplane is capable, in the en route configuration and with all power units operating within the specified maximum continuous power conditions, of a rate of climb of 700 feet per minute if it has retractable landing gear and of 500 feet per minute if it has fixed landing gear; and
 - (ii) the weight at which the aeroplane is capable, in the en route configuration and if it is necessary for it to be flown solely by reference to instruments for any period before reaching the minimum altitude for safe flight on the first stage of the route to be flown, stated in, or calculated from the information contained in, the operations

Status: This is the original version (as it was originally made). This item of legislation is currently only available in its original format.

- manual relating to the aeroplane and, with one power unit inoperative, of a rate of climb of 150 feet per minute.
- (b) The distance required by the aeroplane to attain a height of 50 feet, with all power units operating within the maximum take off power conditions specified, when multiplied by a factor of 1.33 does not exceed the emergency distance available at the aerodrome at which the take off is to be made. The distance required by the aeroplane to attain a height of 50 feet shall be that appropriate to—
- (i) the weight of the aeroplane at the commencement of the take off run;
 - (ii) the altitude at the aerodrome;
 - (iii) the air temperature at the aerodrome; and
 - (iv) not more than 50 per cent. of the reported wind component opposite to the direction of take off or not less than 150 per cent. of the reported wind component in the direction of take off.
- (c) The aeroplane, at any time after it reaches a height of 1,000 feet above the aerodrome from which take off is to be made, will, in the meteorological conditions expected for the flight, in the event of any one power unit becoming inoperative at any point on its route or on any planned diversion therefrom, and with the other power unit or units, if any, operating within the specified maximum continuous power conditions, be capable of continuing the flight at altitudes not less than the relevant minimum altitude for the safe flight stated in, or calculated from the information contained in, the operations manual relating to the aeroplane to a point 1,000 feet above a place at which a safe landing can be made: in assessing the ability of the aeroplane to satisfy this condition it shall not be assumed to be capable of flying at any point on its route or on any planned diversion therefrom at an altitude exceeding that at which it is capable of a rate of climb with all power units operating within the maximum continuous power conditions specified of 150 feet per minute and, if it is necessary for it to be flown solely by reference to instruments, be capable, with one power unit inoperative, of a rate of climb of 100 feet per minute.
- (d) The landing weight of the aeroplane for the altitude and the expected air temperature for the estimated time of landing at the aerodrome at which it is intended to land and at any alternate aerodrome will not exceed the maximum landing weight specified:
- (i) at which the aeroplane is capable, in the en route configuration and with all power units operating within the specified maximum continuous power conditions, of a rate of climb of 700 feet per minute if it has retractable landing gear and of 500 feet per minute if it has fixed landing gear; and
 - (ii) at which the aeroplane is capable in the en route configuration and if it is necessary for it to be flown solely by reference to instruments for any period after leaving the minimum altitude for safe flight on the last stage of the route to be flown, stated in, or calculated from the information contained in, the operations manual relating to the aeroplane and with one power unit inoperative, of a rate of climb of 150 feet per minute.
- (e) The landing distance required does not, at the aerodrome at which it is intended to land and at any alternate aerodrome exceed 70 per cent. of the landing distance available on the most suitable runway for a landing in still air conditions, and for the purposes of this sub-paragraph the distance required to land from a height of 50 feet shall be taken to be that specified as being appropriate to:
- (i) the landing weight;
 - (ii) the altitude at the aerodrome; and

Status: This is the original version (as it was originally made). This item of legislation is currently only available in its original format.

- (iii) the temperature in the specified international standard atmosphere appropriate to the altitude at the aerodrome.
- (a) (2) (a) Subject to sub-paragraph (b), an aeroplane designated as aforesaid as an aeroplane of performance group E shall not fly for the purpose of public transport at night or when the cloud ceiling or visibility prevailing at the aerodrome of departure and forecast for the estimated time of landing at the aerodrome at which it is intended to land and at any alternate aerodrome are less than 1,000 feet and one nautical mile respectively.
- (b) Sub-paragraph (a) shall not apply if the aeroplane is capable, in the en route configuration and with one power unit inoperative, of a rate of climb of 150 feet per minute.

Weight and performance of public transport aeroplanes classified as aeroplanes of performance group F in their certificates of airworthiness

9. For the purposes of article 36(1), an aeroplane registered in the Territory in respect of which there is in force under this Order a certificate of airworthiness in which the aeroplane is designated as being of performance group F shall not fly for the purpose of public transport unless the weight of the aeroplane at the commencement of the take off run is such that the following conditions are satisfied:

- (1) That weight does not exceed the maximum take off weight specified for the altitude and the air temperature at the aerodrome at which the take off is to be made.
- (2) The take off distance required specified as being appropriate to:
 - (a) the weight of the aeroplane at the commencement of the take off run;
 - (b) the altitude at the aerodrome;
 - (c) the air temperature at the aerodrome; and
 - (d) the average slope of the surface of the aerodrome in the direction of take off over the take off run available; and not more than 50 per cent. of the reported wind component opposite to the direction of take off or not less than 150 per cent. of the reported wind component in the direction of take off,

does not exceed the take off run available at the aerodrome at which the take off is to be made.

- (a) (3) (a) Subject to sub-paragraph (b), the aeroplane, at any time after it reaches a height of 1,000 feet above the aerodrome from which take off is to be made, will, in the meteorological conditions expected for the flight, in the event of any one power unit becoming inoperative at any point on its route or on any planned diversion therefrom, and with the other power unit or power units, if any, operating within the specified maximum continuous power conditions, be capable of continuing the flight at altitudes not less than the relevant minimum altitude for safe flight stated in, or calculated from the information contained in, the operations manual relating to the aeroplane to a point 1,000 feet above:
 - (i) in the case of an aeroplane having one power unit, a place at which a safe landing can be made; and
 - (ii) in the case of an aeroplane having two or more power units, an aerodrome at which it can comply with condition (5).
- (b) In assessing the ability of the aeroplane to satisfy this condition—
 - (i) the aeroplane shall not be assumed to be capable of flying, at any point on its route or on any planned diversion therefrom, at an altitude exceeding that at which it is capable of a gradient of climb, with all power units operating within maximum continuous power conditions specified, of 2 per cent; and
 - (ii) over those parts of the route or any planned diversion therefrom, where in the meteorological conditions expected for the flight it is expected that the aeroplane will be out of sight of the surface due to cloud cover at or below the relevant

minimum safe altitude, the aeroplane shall be required to be capable of a gradient of climb, with one power unit inoperative and with the other power unit or power units operating within the specified maximum continuous power conditions, at the relevant minimum safe altitude, of 1 per cent.

(4) The landing weight of the aeroplane will not exceed the maximum landing weight specified for the altitude and the expected air temperature for the estimated time of landing at the aerodrome at which it is intended to land and at any alternate aerodrome.

- (a) (5) (a) The landing distance required does not exceed at the aerodrome at which it is intended to land or at any alternate aerodrome, as the case may be, the landing distance available on the most suitable runway for a landing in still air conditions.
- (b) For the purposes of sub-paragraph (a) the landing distance required shall be that specified as being appropriate to—
 - (i) the landing weight;
 - (ii) the altitude at the aerodrome;
 - (iii) the temperature in the specified international standard atmosphere appropriate to the altitude at the aerodrome;
 - (iv) a runway with a level surface; and
 - (v) still air conditions.

(6) A single-engined aeroplane designated as aforesaid as an aeroplane of performance group F shall not fly for the purpose of public transport at night or when the cloud ceiling or visibility prevailing at the aerodrome of departure or forecast for the estimated time of landing at the aerodrome at which it is intended to land and at any alternate aerodrome are less than 1,000 feet and one nautical mile respectively.

Weight and performance of public transport aeroplanes classified as aeroplanes of performance group X in their certificates of airworthiness

10. For the purpose of article 36(1), an aeroplane in respect of which there is in force under this Order a certificate of airworthiness designating the aeroplane as being of performance group X shall not fly for the purpose of public transport unless the weight of the aeroplane at the commencement of the take off run is such that the following conditions are satisfied:

- (a) (1) (a) That weight does not exceed the maximum take off weight specified for the altitude at the aerodrome at which the take off is to be made, or for the altitude and the air temperature at such aerodrome, as the case may be.
- (b) The minimum effective take off runway length required, specified as being appropriate to:
 - (i) the weight of the aeroplane at the commencement of the take off run;
 - (ii) the altitude at the aerodrome;
 - (iii) the air temperature at the time of take off;
 - (iv) the condition of the surface of the runway from which the take off will be made;
 - (v) the overall slope of the take off run available; and
 - (vi) not more than 50 per cent. of the reported wind component opposite to the direction of take off or not less than 150 per cent. of the reported wind component in the direction of take off,does not exceed the take off run available at the aerodrome at which the take off is to be made.
- (c) (i) The take off flight path with one power unit inoperative, specified as being appropriate to:—

Status: This is the original version (as it was originally made). This item of legislation is currently only available in its original format.

- (aa) the weight of the aeroplane at the commencement of the take off run;
- (bb) the altitude at the aerodrome; and
- (cc) not more than 50 per cent. of the reported wind component opposite to the direction of take off or not less than 150 per cent. of the reported wind component in the direction of take off,

and plotted from a point 50 feet above the end of the minimum effective take off runway length required at the aerodrome at which the take off is to be made, shows that the aeroplane will thereafter clear any obstacle in its path by a vertical interval of not less than the greater of 50 feet or 35 feet plus one-hundredth of the distance from the point on the ground below the intended line of flight of the aeroplane nearest to the obstacle to the end of the take off distance available, measured along the intended line of flight of the aeroplane.

- (ii) For the purpose of sub-paragraph (i) an obstacle shall be deemed to be in the path of the aeroplane if the distance from the obstacle to the nearest point on the ground below the intended line of flight does not exceed:
 - (aa) a distance of 60 metres plus half the wing span of the aeroplane plus one-eighth of the distance from such point to the end of the take off distance available measured along the intended line of flight; or

- (bb) 900 metres,

whichever is the less.

- (iii) In assessing the ability of the aeroplane to satisfy this condition, in so far as it relates to flight path, it shall not be assumed to make a change of direction of a radius less than the radius of steady turn corresponding to an angle of bank of 15°.

- (a) (i) Subject to sub-paragraph (ii), the weight of the aeroplane at any point on the route or any planned diversion therefrom, having regard to the fuel and oil expected to be consumed up to that point, shall be such that the aeroplane, with one power unit inoperative and the other power unit or units operating within the maximum continuous power conditions specified, will be capable of a rate of climb of at least $K(V_{so}/100)^2$ feet per minute at an altitude not less than the minimum altitude for safe flight stated in or calculated from the information contained in the operations manual relating to the aeroplane, where V_{so} is in knots and K has the value of $797 - 1060/N$, N being the number of power units installed.
- (ii) Subject to sub-paragraph (iii), as an alternative to sub-paragraph (i), the aeroplane may be flown at an altitude from which, in the event of failure of one power unit, it is capable of reaching an aerodrome where a landing can be made in accordance with sub-paragraph (b) of condition (3) relating to an alternate aerodrome. In that case the weight of the aeroplane shall be such that, with the remaining power unit or units operating within the maximum continuous power conditions specified, it is capable of maintaining a minimum altitude on the route to such aerodrome of 2,000 feet above all obstacles within 10 nautical miles on either side of the intended track.
- (iii) Where the operator of the aeroplane is satisfied, taking into account the navigation aids which can be made use of by the aeroplane on the route, that the commander of the aeroplane will be able to maintain his intended track on that route within a margin of five nautical miles, the provisions of sub-paragraph (ii) shall have effect as if five nautical miles were substituted therein for 10 nautical miles and
 - (aa) the rate of climb, specified for the appropriate weight and altitude, used in calculating the flight path shall be reduced by an amount equal to $K(V_{so}/100)^2$ feet per minute;

- (bb) the aeroplane shall comply with the climb requirements of sub-paragraph (a) (i) of condition (2) at 1,000 feet above the chosen aerodrome;
 - (cc) account shall be taken of the effect of wind and temperature on the flight path; and
 - (dd) the weight of the aeroplane may be assumed to be progressively reduced by normal consumption of fuel and oil.
- (b) An aeroplane having four power units shall, if any two power units become inoperative at any point along the route or any planned diversion therefrom, being a point more than 90 minutes flying time (assuming all power units to be operating) from the nearest aerodrome at which a landing can be made in compliance with sub-paragraph (b) of condition (3) relating to an alternate aerodrome, be capable of continuing the flight at an altitude of not less than 1,000 feet above ground level to a point above that aerodrome. In assessing the ability of the aeroplane to satisfy this condition, it shall be assumed that the remaining power units will operate within the specified maximum continuous power conditions, and account shall be taken of the temperature and wind conditions expected for the flight.
- (a) (3) (a) The landing weight of the aeroplane will not exceed the maximum landing weight specified for the altitude at the aerodrome at which it is intended to land and at any alternate aerodrome.
- (b) The required landing runway lengths respectively specified as being appropriate to the aerodrome of intended destination and the alternate aerodromes do not exceed at the aerodrome at which it is intended to land or at any alternate aerodrome, as the case may be, the landing distance available on:
- (i) the most suitable runway for landing in still air conditions; and
 - (ii) the runway that may be required for landing because of the forecast wind conditions, the required landing runway lengths being taken to be those specified as being appropriate to:
 - (aa) the landing weight;
 - (bb) the altitude at the aerodrome;
 - (cc) still air conditions in the case of the most suitable runway for a landing in still air conditions; and
 - (dd) not more than 50 per cent. of the forecast wind component opposite to the direction of landing or not less than 150 per cent. of the forecast wind component in the direction of landing in the case of the runway that may be required for landing because of the forecast wind conditions.

Weight and performance of public transport helicopters classified as helicopters of performance group A in their certificate of airworthiness

11. For the purposes of article 36(1), a helicopter registered in the Territory in respect of which there is in force under this Order a certificate of airworthiness in which the helicopter is designated as being of performance group A shall not fly for the purpose of public transport unless the weight of the helicopter at the commencement of take off is such that the following conditions are satisfied:

- (1) The weight does not exceed the maximum take off weight specified for the altitude and the air temperature at the site from which the take off is to be made.
- (2) The landing weight of the helicopter will not exceed the maximum landing weight specified for the altitude and the expected air temperature for the estimated time of landing at the site at which it is intended to land and at any alternate site.

Status: This is the original version (as it was originally made). This item of legislation is currently only available in its original format.

Weight and performance of public transport helicopters classified as helicopters of performance group A (Restricted) in their certificate of airworthiness

12.—(1) Subject to paragraph (2), for the purposes of article 36(1), a helicopter registered in the Territory in respect of which there is in force under this Order a certificate of airworthiness in which the helicopter is designated as being of performance group A (Restricted) shall not fly for the purpose of public transport when the cloud ceiling or visibility prevailing at the departure site and forecast for the estimated time of landing at the site at which it is intended to land and at any alternate site are less than 500 feet and 1,000 metres respectively and shall not fly for the purpose of public transport at any other time unless the weight of the helicopter at the commencement of take off is such that the following conditions are satisfied:

- (a) The weight does not exceed the maximum take off weight specified for the altitude and the air temperature at the site from which the take off is to be made.
- (b) The landing weight of the helicopter will not exceed the maximum landing weight specified for the altitude and the expected air temperature for the estimated time of landing at the site at which it is intended to land and at any alternate site.

(2) This regulation shall not apply to a helicopter flying under and in accordance with the terms of a police air operator's certificate.

Weight and performance of public transport helicopters classified as helicopters of performance group B in their certificate of airworthiness

13.—(1) Subject to sub-paragraph (2), for the purposes of article 36(1), a helicopter registered in the Territory in respect of which there is in force under this Order a certificate of airworthiness in which the helicopter is designated as being of performance group B shall not fly for the purpose of public transport at night or out of sight of the surface or when the cloud ceiling or visibility prevailing at the departure site and forecast for the estimated time of landing at the site at which it is intended to land are less than 600 feet and 1,000 metres respectively and shall not fly for the purpose of public transport at any other time unless the weight of the helicopter at the commencement of take off is such that the following conditions are satisfied:

- (a) The weight does not exceed the maximum take off weight specified for the altitude and the air temperature at the site from which the take off is made.
- (b) The landing weight of the helicopter will not exceed the maximum landing weight specified for the altitude and the expected air temperature for the estimated time of landing at the site at which it is intended to land and at any alternate site.

(2) This regulation shall not apply to a helicopter flying under and in accordance with the terms of a police air operator's certificate.

Noise and vibration caused by aircraft on aerodromes

14. For the purposes of article 108, the conditions under which noise and vibration may be caused by aircraft (including military aircraft) on Government aerodromes, licensed aerodromes or on aerodromes at which the manufacture, repair or maintenance of aircraft is carried out by persons carrying on business as manufacturers or repairers of aircraft, shall be as follows:

- (a) the aircraft is taking off or landing; or
- (b) the aircraft is moving on the ground or water; or
- (c) the engines are being operated in the aircraft:—
 - (i) for the purpose of ensuring their satisfactory performance;
 - (ii) for the purpose of bringing them to a proper temperature in preparation for, or at the end of, a flight; or

- (iii) for the purpose of ensuring that the instruments, accessories or other components of the aircraft are in a satisfactory condition.

Certificates of maintenance review and of release to service-issue by maintenance engineers licensed by prescribed countries

15. For the purpose of articles 10(3)(a)(i)(cc) and 12(8)(a)(iii), the following countries are hereby specified:

Anguilla	Kuwait
Antigua	Malawi
Australia	Malaysia
Bahamas	Montserrat
Barbados	New Zealand
Belize	Pakistan
British Virgin Islands	St Christopher and Nevis
Brunei Darussalam	St Lucia
Burma	St Vincent and the Grenadines
Canada	Singapore
Cayman Islands	Republic of South Africa
Dominica	Sri Lanka
Ghana	Sudan
Grenada	Trinidad and Tobago
Guyana	Turks and Caicos Islands
Hong Kong	Tanzania
India	Uganda
Republic of Ireland	United Kingdom
Jamaica	Zambia
Kenya	

Aeroplanes flying for the purpose of public transport of passengers—aerodrome facilities for approach to landing and landing

16.—(1) This regulation shall apply to every aeroplane registered in the Territory engaged on a flight for the purpose of public transport of passengers on a scheduled journey and to every aeroplane so registered whose maximum total weight authorised exceeds 5,700 kg engaged on such a flight otherwise than on a scheduled journey.

(2) For the purposes of article 34(1)(c), the following manning and equipment are specified in relation to aerodromes intended to be used for landing or as an alternate aerodrome by aircraft to which this regulation applies:—

- (a) air traffic control service or aerodrome flight information service, including the reporting to aircraft of the current meteorological conditions at the aerodrome;

Status: This is the original version (as it was originally made). This item of legislation is currently only available in its original format.

- (b) very high frequency radiotelephony;
- (c) at least one of the following radio navigation aids, either at the aerodrome or elsewhere, and in either case for the purpose of assisting the pilot in locating the aerodrome and in making an approach to landing there:—
 - (i) radio direction finding equipment utilising emissions in the very high frequency bands;
 - (ii) a non-directional radio beacon transmitting signals in the low or medium frequency bands;
 - (iii) very high frequency omni-directional radio range;
 - (iv) radio navigation land stations forming part of the Decca radio navigation system;
 - (v) radar equipment.

It shall be sufficient if the equipment specified in sub-paragraph (c) is provided, even if for the time being it is not in operation

(3) An aircraft to which this regulation applies shall not land or make an approach to landing at any aerodrome unless services and equipment according with paragraph (2) are provided and are in operation at that aerodrome, and can be made use of by that aircraft, and, in the case of the navigation aids specified in sub-paragraph (c), items (i) to (iv), instructions and procedures for the use of the aid are included in the operations manual relating to the aircraft. A person shall be deemed not to have contravened the provisions of this paragraph if he proves that:—

- (a) for the time being use could not be made of the radio navigation aids provided under sub-paragraph (2)(c) whether by reason of those aids not being in operation or of the unserviceability of equipment in the aircraft itself; and
- (b) the approach to landing was made in accordance with instructions and procedures appropriate to that circumstance and included in the operations manual.

Pilots maintenance-prescribed repairs or replacements

17. For the purposes of article 12(5), the following repairs or replacements are hereby specified:

- (1) Replacement of landing gear tyres, landing skids or skid shoes;
- (2) Replacement of elastic shock absorber cord units on landing gear where special tools are not required;
- (3) Replacement of defective safety wiring or split pins excluding those in engine, transmission, flight control and rotor systems;
- (4) Patch-repairs to fabric not requiring rib stitching or the removal of structural parts or control surfaces, if the repairs do not cover up structural damage and do not include repairs to rotor blades;
- (5) Repairs to upholstery and decorative furnishing of the cabin or cockpit interior when repair does not require dismantling of any structure or operating system or interfere with an operating system or affect the structure of the aircraft;
- (6) Repairs, not requiring welding, to fairings, non-structural cover plates and cowlings;
- (7) Replacement of side windows where that work does not interfere with the structure or with any operating system;
- (8) Replacement of safety belts or safety harness;
- (9) Replacement of seats or seat parts not involving dismantling of any structure or of any operating system;
- (10) Replacement of bulbs, reflectors, glasses, lenses or lights;

- (11) Replacement of any cowling not requiring removal of the propeller, rotors, or disconnection of engine or flight controls;
- (12) Replacement of unserviceable sparking plugs;
- (13) Replacement of batteries;
- (14) Replacement of wings and tail surfaces and controls, the attachments of which are designed to provide for assembly immediately before each flight and dismantling after each flight;
- (15) Replacement of main rotor blades that are designed for removal where special tools are not required;
- (16) Replacement of generator and fan belts designed for removal where special tools are not required;
- (17) Replacement of VHF communication equipment, being equipment which is not combined with navigation equipment.

Mandatory reporting—prescribed reportable occurrences, time and manner of reporting and information to be reported

18.—(1) For the purposes of article 117(1), the following reportable occurrences are hereby specified, that is to say those:—

- (a) involving damage to an aircraft;
- (b) involving injury to a person;
- (c) involving the impairment during a flight of the capacity of a member of the flight crew of an aircraft to undertake the functions to which his licence relates;
- (d) involving the use in flight of any procedures taken for the purpose of overcoming an emergency;
- (e) involving the failure of an aircraft system or of any equipment of an aircraft;
- (f) arising from the control of an aircraft in flight by its flight crew;
- (g) arising from failure or inadequacy of facilities or services on the ground used or intended to be used for the purposes of or in connection with the operation of aircraft;
- (h) arising from the loading or the carriage of passengers, cargo (including mail) or fuel;

and those which are not referred to in sub-paragraphs (a) to (h) but which, in the opinion of a person referred to in sub-paragraphs (a) to (e) of article 117(1), constitute an occurrence endangering, or which if not corrected would endanger, the safety of an aircraft, its occupants or any other person.

(2) For the purposes of this regulation, an aircraft system includes the flight control, power plant, fuel, hydraulic, pneumatic, pressurisation, electrical, navigation and any other system of the aircraft.

- (a) (3) (a) Subject to sub-paragraph (b), for the purposes of article 117(1), it is hereby specified that a report containing the information referred to in paragraph (4) shall be despatched in writing, or in such other form as the Governor may approve, and by the quickest available means to the Governor within 96 hours of the reportable occurrence coming to the knowledge of the person making the report.
- (b) If at that time any of the said information is not in the possession of the person making the report, he shall despatch that information to the Governor in writing, or in such other form as the Governor may approve, and by the quickest available means within 96 hours of the information coming into his possession.

(4) For the purposes of article 117(1), a report shall, as far as possible, contain the following information:

- (a) the type, series and registration marks of the aircraft concerned;

Status: This is the original version (as it was originally made). This item of legislation is currently only available in its original format.

- (b) the name of the operator of the aircraft;
- (c) the date of the reportable occurrence;
- (d) if the person making the report has instituted an investigation into the reportable occurrence, whether or not this has been completed;
- (e) a description of the reportable occurrence, including its effects and any other relevant information;
- (f) in the case of a reportable occurrence which occurs during flight:
 - (i) the Co-ordinated Universal Time of the occurrence;
 - (ii) the last point of departure and the next point of intended landing of the aircraft at that time; and
 - (iii) the geographical position of the aircraft at that time;
- (g) in the case of a defect in or malfunctioning of an aircraft or any part or equipment of an aircraft, the name of the manufacturer of the aircraft, part or equipment, as the case may be, and, where appropriate, the part number and modification standard of the part or equipment and its location on the aircraft;
- (h) the signature and name in block capitals of the person making the report, the name of his employer and the capacity in which he acts for that employer; and
- (i) in the case of a report made by the commander of an aircraft or a person referred to in sub-paragraph (c) or (d) of article 117(1), the address or telephone number at which communications should be made to him, if different from that of his place of employment.

Minimum navigation and height keeping performance—capability and prescribed airspace and navigation performance

19.—(1) For the purposes of article 47(1) the following navigation performance capability is hereby specified, that is to say, a capability to ensure that—

- (a) the standard deviation of lateral errors in the track of the aircraft is not more than 6.3 nautical miles; and
- (b) the proportion of the flight time of the aircraft during which the actual track of the aircraft is 30 nautical miles or more off the track along which it has been given an air traffic control clearance to fly is less than 5.3×10^{-4} and
- (c) the proportion of the flight time of the aircraft during which the actual track of the aircraft is between 50 and 70 nautical miles off the track along which it has been given an air traffic control clearance to fly is less than 13×10^{-5}

(2) For the purposes of article 48(1) the following height keeping performance capability is hereby specified, that is to say, a capability to ensure that:

- (a) altimetry system error shall be in compliance with paragraph 2.1.1(2) of Document 7030/4-NAT Part 1 Rules of the Air, Air Traffic Services and Search and Rescue (ICAO Regional Procedures Fourth Edition-1987); and
- (b)
 - (i) in respect of aircraft first registered in a Contracting State on or after 1st January 1997 altitude can be automatically controlled within a tolerance band of ± 65 feet;
 - (ii) in respect of aircraft first registered in a Contracting State before 1st January 1997 altitude can be automatically controlled within a tolerance band of ± 130 feet.

(3) For the purposes of article 47(1), the following airspace is hereby specified as North Atlantic Minimum Navigation Performance Specification Airspace, that is to say, the airspace from flight level 285 to flight level 420 within the area defined by rhumb lines joining successively the following points—

N3410.00 W01748.00	N8200.00 E03000.00	N4500.00 W05300.00
N3630.00 W01500.00	North Pole	N4336.00 W06000.00
N4200.00 W01500.00	N8200.00 W06000.00	N4152.00 W06700.00
N4300.00 W01300.00	N7800.00 W07500.00	N3900.00 W06700.00
N4500.00 W01300.00	N7600.00 W07600.00	N3835.00 W06853.00
N4500.00 W00800.00	N6500.00 W05745.00	N3830.00 W06915.00
N5100.00 W00800.00	N6500.00 W06000.00	N3830.00 W06000.00
N5100.00 W01500.00	N6400.00 W06300.00	N2700.00 W06000.00
N5400.00 W01500.00	N6100.00 W06300.00	N2700.00 W02500.00
N5434.00 W01000.00	N5700.00 W05900.00	N3000.00 W02500.00
N6100.00 W01000.00	N5300.00 W05400.00	N3000.00 W02000.00
N6100.00 00000.00	N4900.00 W05100.00	N3139.00 W01725.00
N8200.00 00000.00	N4500.00 W05100.00	

thence by that part of the arc to circle radius 100 nautical miles centred on N3304.00 W01621.00 to N3410.00 W01748.00.

Requirements for airborne collision avoidance systems

20. For the purposes of paragraph 4(5) of Schedule 5 to this Order the prescribed requirements for an airborne collision avoidance system shall be the requirements for ACAS II equipment set out in Volume 4 Chapter 4 of Annex 10 (first edition) to the Chicago Convention.
Regulation 4

ANNEX

Weight and performance of public transport aeroplanes having no performance group classification in their certificates of airworthiness

Conditions (1) and (2) apply to all aeroplanes to which regulation 4 applies;

Conditions (3) to (10) apply to all aeroplanes to which regulation 4 applies—

- (a) of which the specified maximum total weight authorised exceeds 5,700 kg, or
- (b) of which the specified maximum total weight authorised does not exceed 5,700 kg, and which comply with neither sub-paragraph (a) nor (b) of condition (1);

Conditions (11) to (18) inclusive apply to all aeroplanes to which regulation 4 applies of which the specified maximum total weight authorised does not exceed 5,700 kg, and which comply with sub-paragraph (a) or (b) of condition (1) or with both those sub-paragraphs.

All aeroplanes

(1) Either—

- (a) the wing loading of the aeroplane does not exceed 20 lb per square foot; or
- (b) the stalling speed of the aeroplane in the landing configuration does not exceed 60 knots; or

Status: This is the original version (as it was originally made). This item of legislation is currently only available in its original format.

- (c) the aeroplane, with any one of its power units inoperative and the remaining power unit or units operating within the maximum continuous power conditions specified, is capable of a gradient of climb of at least 1 in 200 at an altitude of 5,000 feet in the specified international standard atmosphere.
- (2) The weight of the aeroplane at the commencement of the take off run does not exceed the maximum take off weight, if any, specified for the altitude and the air temperature at the aerodrome at which the take off is to be made.

Aeroplanes of a specified maximum total weight authorised exceeding 5,700 kg and aeroplanes of a specified maximum total weight authorised not exceeding 5,700 kg which comply with neither sub-paragraph (a) nor (b) of condition (1)

- (a) (3) (a) The distance required by the aeroplane to attain a height of 50 feet, with all power units operating within the maximum take off power conditions specified does not exceed the take off run available at the aerodrome at which the take off is to be made.
- (b) The distance required by the aeroplane to attain a height of 50 feet with all power units operating within the maximum take off power conditions specified, when multiplied by a factor of either 1.33 for aeroplanes having two power units or by a factor of 1.18 for aeroplanes having four power units, does not exceed the emergency distance available at the aerodrome at which the take off is to be made.
- (c) For the purposes of sub-paragraphs (a) and (b) the distance required by the aeroplane to attain a height of 50 feet shall be that appropriate to:
 - (i) the weight of the aeroplane at the commencement of the take off run;
 - (ii) the altitude at the aerodrome;
 - (iii) the air temperature at the aerodrome;
 - (iv) the condition of the surface of the runway from which the take off will be made;
 - (v) the slope of the surface of the aerodrome in the direction of take off over the take off run available and the emergency distance available, respectively; and
 - (vi) not more than 50 per cent of the reported wind component opposite to the direction of take off or not less than 150 per cent of the reported wind component in the direction of take off.
- (a) (4) (a) The take off flight path with one power unit inoperative and the remaining power unit or units operating within the maximum take off power conditions specified, appropriate to:—
 - (i) the weight of the aeroplane at the commencement of the take off run;
 - (ii) the altitude of the aerodrome;
 - (iii) the air temperature at the aerodrome; and
 - (iv) not more than 50 per cent of the reported wind component opposite to the direction of take off or not less than 150 per cent of the reported wind component in the direction of take off,

and plotted from a point 50 feet above the end of the appropriate factored distance required for take off under sub-paragraph (b) of condition (3) at the aerodrome at which the take off is to be made, shows that the aeroplane will clear any obstacle in its path by a vertical interval of at least 35 feet except that if it is intended that an aeroplane shall change its direction by more than 15° the vertical interval shall be not less than 50 feet during the change of direction.

- (b) For the purpose of sub-paragraph (a) an obstacle shall be deemed to be in the path of the aeroplane if the distance from the obstacle to the nearest point on the ground below the intended line of flight does not exceed:—
- (i) a distance of 60 metres plus half the wing span of the aeroplane, plus one-eighth of the distance from such point to the end of the take off distance available, measured along the intended line of flight; or
 - (ii) 900 metres,
- whichever is the less.
- (c) In assessing the ability of the aeroplane to satisfy this condition, it shall not be assumed to make a change of direction of a radius less than a radius of steady turn corresponding to an angle of bank of 15°.

(5) The aeroplane will, in the meteorological conditions expected for the flight, in the event of any one power unit becoming inoperative at any point on its route or on any planned diversion therefrom and with the other power unit or units, if any, operating within the maximum continuous power conditions specified, be capable of continuing the flight, clearing obstacles within 10 nautical miles either side of the intended track by a vertical interval of at least:

- (a) 1,000 feet when the gradient of the flight path is not less than zero; or
- (b) 2,000 feet when the gradient of the flight path is less than zero,

to an aerodrome at which it can comply with condition (9), and on arrival over such aerodrome the flight path shall have a gradient of not less than zero at 1,500 feet above the aerodrome.

For the purpose of this condition the gradient of climb of the aeroplane shall be taken to be 1 per cent. less than that specified.

(6) The aeroplane will, in the meteorological conditions expected for the flight, at any point on its route or on any planned diversion therefrom be capable of climbing at a gradient of at least 1 in 50, with all power units operating within the maximum continuous power conditions specified at the following altitudes:

- (a) the minimum altitudes for safe flight on each stage of the route to be flown or of any planned diversion therefrom specified in, or calculated from the information contained in, the operations manual relating to the aeroplane; and
- (b) the minimum altitudes necessary for compliance with conditions (5) and (7), as appropriate.

(7) If on the route to be flown or any planned diversion therefrom, the aeroplane will be engaged in a flight over water during which at any point it may be more than 90 minutes flying time in still air from the nearest shore, it will in the event of two power units becoming inoperative during such time and with the other power unit or units, if any, operating within the maximum continuous power conditions specified be capable of continuing the flight having regard to the meteorological conditions expected for the flight, clearing all obstacles within 10 nautical miles either side of the intended track by a vertical interval of at least 1,000 feet, to an aerodrome at which a safe landing can be made.

(8) The landing weight of the aeroplane will not exceed the maximum landing weight, if any, specified for the altitude and the expected air temperature for the estimated time of landing at the aerodrome at which it is intended to land and at any alternate aerodrome.

(9) The distance required by the aeroplane to land from a height of 50 feet does not, at the aerodrome at which it is intended to land, exceed 60 per cent. of the landing distance available on:

- (a) the most suitable runway for a landing in still air conditions; and
- (b) (i) subject to sub-paragraph (ii), the runway that may be required for landing because of the forecast wind conditions;

Status: This is the original version (as it was originally made). This item of legislation is currently only available in its original format.

- (ii) if an alternate aerodrome is designated in the flight plan the landing distance required at the aerodrome at which it is intended to land shall not exceed 70 per cent. of that available on the runway.

The distance required to land from a height of 50 feet shall be taken to be that appropriate to:

- (i) the landing weight;
- (ii) the altitude at the aerodrome;
- (iii) the temperature in the specified international standard atmosphere appropriate to the altitude at the aerodrome;
- (iv) (aa) a level surface in the case of runways usable in both directions;
(bb) the average slope of the runway in the case of runways usable in only one direction;
and
- (v) (aa) still air conditions in the case of the most suitable runway for a landing in still air conditions; and
(bb) not more than 50 per cent. of the forecast wind component opposite to the direction of landing or not less than 150 per cent. of the forecast wind component in the direction of landing in the case of the runway that may be required for landing because of the forecast wind conditions.

(10) The distance required by the aeroplane to land from a height of 50 feet does not, at any alternate aerodrome exceed 70 per cent. of the landing distance available on:

- (a) the most suitable runway for a landing in still air conditions; and
- (b) the runway that may be required for landing because of the forecast wind conditions;

For the purpose of this condition the distance required to land from a height of 50 feet shall be determined in the manner provided in condition (9).

Aeroplanes of a specified maximum total weight authorised not exceeding 5,700 kg and which comply with either sub-paragraph (a) or (b) of condition (1), or with both those sub-paragraphs

(11) If the aeroplane is engaged on a flight at night or when the cloud ceiling or visibility prevailing at the aerodrome of departure and forecast for the estimated time of landing at the aerodrome of destination or at any alternate aerodrome are less than 1,000 feet and one nautical mile respectively, it will, with any one of its power units inoperative and the remaining power unit or units, if any, operating within the maximum continuous power conditions specified, be capable of climbing at a gradient of at least 1 in 200 at an altitude of 2,500 feet in the specified international standard atmosphere.

- (a) (12) (a) The distance required by the aeroplane to attain a height of 50 feet with all power units operating within the maximum take off power conditions specified, does not exceed the take off available at the aerodrome at which the take off is to be made;
- (b) The distance required by the aeroplane to attain a height of 50 feet, with all power units operating within the maximum take off power conditions specified, when multiplied by a factor of 1.33 does not exceed the emergency distance available at the aerodrome at which the take off is to be made;
- (c) For the purposes of sub-paragraphs (a) and (b) the distance required by the aeroplane to attain a height of 50 feet shall be that appropriate to:
 - (i) the weight of the aeroplane at the commencement of the take off run;
 - (ii) the altitude of the aerodrome;

Status: This is the original version (as it was originally made). This item of legislation is currently only available in its original format.

- (iii) the temperature in the specified international standard atmosphere appropriate to the altitude at the aerodrome or, if greater, the air temperature at the aerodrome less 15° centigrade;
- (iv) the slope of the surface of the aerodrome in the direction of take off over the take off run available and the emergency distance available respectively; and
- (v) not more than 50 per cent. of the reported wind component opposite to the direction of take off or not less than 150 per cent. of the reported wind component in the direction of take off.

(13) The take off flight path, with all power units operating within the maximum take off power conditions specified, appropriate to:

- (a) the weight of the aeroplane at the commencement of the take off run;
- (b) the altitude at the aerodrome;
- (c) the temperature in the specified international standard atmosphere appropriate to the altitude at the aerodrome, or, if greater, the air temperature at the aerodrome less 15° centigrade; and
- (d) not more than 50 per cent. of the reported wind component opposite to the direction of take off or not less than 150 per cent. of the reported wind component in the direction of take off,

and plotted from a point 50 feet above the end of the factored distance required for take off under subparagraph (b) of condition (12), at the aerodrome at which the take off is to be made, shows that the aeroplane will clear any obstacle lying within 60 metres plus half the wing span of the aeroplane on either side of its path by a vertical interval of at least 35 feet. In assessing the ability of the aeroplane to satisfy this condition it shall not be assumed to make a change of direction of a radius less than a radius of steady turn corresponding to an angle of bank of 15°.

(14) The aeroplane will, in the meteorological conditions expected for the flight, in the event of any power unit becoming inoperative at any point on its route or on any planned diversion therefrom and with the other power unit or units, if any, operating within the maximum continuous power conditions specified, be capable of continuing the flight so as to reach a point above a place at which a safe landing can be made at a suitable height for such landing.

(15) The aeroplane will, in the meteorological conditions expected for the flight, at any point on its route or any planned diversion therefrom, be capable of climbing at a gradient of at least 1 in 50, with all power units operating within the maximum continuous power conditions specified at the following altitudes—

- (a) the minimum altitudes for safe flight on each stage of the route to be flown or on any planned diversion therefrom specified in, or calculated from, the information contained in the operations manual relating to the aeroplane; and
- (b) the minimum altitudes necessary for compliance with condition (14).

(16) If on the route to be flown or any planned diversion therefrom the aeroplane will be engaged on a flight over water during which at any point it may be more than 30 minutes flying time in still air from the nearest shore, it will, in the event of one power unit becoming inoperative during such time and the other power unit or units, if any, operating within the maximum continuous power conditions specified, be capable of climbing at a gradient of at least 1 in 200 at an altitude of 5,000 feet in the specified international standard atmosphere.

(17) The landing weight of the aeroplane will not exceed the maximum landing weight, if any, specified for the altitude and the expected air temperature for the estimated time of landing at the aerodrome at which it is intended to land and at any alternate aerodrome.

Status: This is the original version (as it was originally made). This item of legislation is currently only available in its original format.

(18) The distance required by the aeroplane to land from a height of 50 feet does not at the aerodrome at which it is intended to land and at any alternate aerodrome, exceed 70 per cent., or, if a visual approach and landing will be possible in the meteorological conditions forecast for the estimated time of landing, 80 per cent. of the landing distance available on—

- (a) the most suitable runway for a landing in still air conditions; and
- (b) the runway that may be required for landing because of the forecast wind conditions, the distance required to land from a height of 50 feet being taken to be that appropriate to—
 - (i) the landing weight;
 - (ii) the altitude at the aerodrome;
 - (iii) the temperature in the specified international standard atmosphere appropriate to the altitude at the aerodrome;
 - (iv) (aa) a level surface in the case of runways usable in only one direction; or
(bb) the average slope of the runway in the case of runways usable in only one direction; and
 - (v) (aa) still air conditions in the case of the most suitable runway for a landing in still air conditions; or
(bb) not more than 50 per cent. of the forecast wind component opposite to the direction of landing or not less than 150 per cent. of the forecast wind component in the direction of landing in the case of the runway that may be required for landing because of the forecast wind conditions.

SCHEDULE 15

Article 60

THE AIR NAVIGATION (DANGEROUS GOODS) REGULATIONS

Interpretation

1.—(1) In these Regulations

“consignment” means one or more packages of dangerous goods accepted by an operator from one shipper at one time and at one address received for in one lot and moving to one consignee at one destination address;

“dangerous goods” means any article or substance which is classified in Part 2 of the Technical Instructions;

“dangerous goods transport document” means a document, not being an air waybill, which is required by regulation 3 to accompany a consignment of dangerous goods;

“package” means the packaging and the articles and substances contained therein including one or more packages which have been consolidated by one shipper into one container or enclosure for convenience in handling;

“packing” means the art and operation whereby articles and substances are wrapped up, enclosed in containers or otherwise secured, and “packed” shall be construed accordingly;

“Technical Instructions” means the 1999–2000 English language edition of the Technical Instructions for the Safe Transport of Dangerous Goods by Air which was approved and published by decision of the Council of the International Civil Aviation Organisation;

“unit load device” means any type of freight container including any container designed for loading on an aircraft.

- (a) (2) (a) Save where the context otherwise requires any reference to:
 - (i) a numbered regulation is to the regulation in these Regulations so numbered;
 - (ii) a numbered paragraph, or numbered or lettered sub-paragraph is a reference to the paragraph or sub-paragraph so numbered or lettered in the regulation or paragraph, as the case may be, in which that reference appears.

(3) For the avoidance of doubt, any instructions or limitations contained in the Technical Instructions for the carriage of dangerous goods on passenger or cargo aircraft, as therein defined, shall for the purpose of these Regulations be interpreted as applying also to the carriage of such goods beneath passenger or cargo aircraft respectively.

Carriage of dangerous goods

2.—(1) An aircraft shall not carry or have loaded therein or suspended thereunder any dangerous goods unless such goods are carried, loaded or suspended:

- (a) with the written permission of the Governor and in accordance with any conditions to which such permission may be subject; and
- (b) in accordance with the Technical Instructions and any conditions specified therein.

(2) A person shall not:

- (a) take or cause to be taken on board,
- (b) suspend or cause to be suspended beneath, or
- (c) deliver or cause to be delivered for loading on or suspension beneath

an aircraft any dangerous goods, which he knows or ought to know or suspect to be goods capable of posing significant risk to health, safety or property when carried by air, unless the Technical Instructions have been complied with and the package of those goods is in a fit condition for carriage by air.

(3) These Regulations shall not apply to dangerous goods of a type specified in Chapters 1.1.2(a), 1.1.2(b) and 2.3 of Part 1 and Chapter 1.2 of Part 9 of the Technical Instructions which are carried, loaded or suspended in accordance with the provisions of the aforesaid Chapters 1.1.2(a), 1.1.2(b) and 2.3 of Part 1 and Chapter 1.2 of Part 9 and which are:

- (a) articles and equipment which are required to be carried on an aircraft by or under this Order or are otherwise intended for use on an aircraft for the purpose of the good order of the flight in accordance with normal practice whether or not, in either case, such articles and equipment are required to be carried or intended to be used on that particular flight;
- (b) solely intended for the use of passengers or crew members or for sale to the passengers or crew members of the aircraft during the flight in question;
- (c) subject to paragraph (4) to provide during flight veterinary aid or a humane killer for an animal; or
- (d) subject to paragraph (4) to provide during flight medical aid to a person.

(4) The goods specified in sub-paragraphs (c) and (d) of paragraph (3) shall only be carried if:

- (a) they are or may be required for use during the flight;
- (b) they are or may be required for use during a subsequent flight by the same aircraft and it will not be practicable to load the goods on the aircraft in the intervening period before the commencement of that subsequent flight; or
- (c) they were used or might have been required for use during a previous flight by the same aircraft and it has not been practicable to unload them from the aircraft since that flight.

Status: This is the original version (as it was originally made). This item of legislation is currently only available in its original format.

(5) Save for regulations 2(1)(a), 6(1) (but only to the extent that it refers to the provisions in Chapter 2.1 of Part 5 of the Technical Instructions), 6(2) and 7(3), these Regulations shall not apply to dangerous goods of the classification specified in Chapter 2.5 of Part 1 of the Technical Instructions:

- (a) which do not exceed the appropriate quantity limitations specified therein; and
- (b) in respect of which such other conditions as are specified therein are complied with.

Documentation

3.—(1) An aircraft shall not carry dangerous goods as cargo unless the shipper of the goods has furnished the operator of the aircraft with a dangerous goods transport document, except that such a document shall not be required in respect of such categories of dangerous goods as may be specified in the Technical Instructions as being goods in respect of which a dangerous goods transport document is not required.

(2) The dangerous goods transport document shall be completed in duplicate by the shipper and shall:

- (a) describe the dangerous goods in accordance with and contain such information as is required by the provisions of Chapter 4.1 of Part 4 of the Technical Instructions;
- (b) contain a signed declaration that the Technical Instructions have been complied with in that the dangerous goods:
 - (i) are fully and accurately described; and
 - (ii) are correctly classified, packed, marked and labelled; and
 - (iii) are in a proper condition for carriage by air.

(3) The shipper of dangerous goods shall furnish the operator of the aircraft with such other documents in respect of dangerous goods as are required by Part 3 and Chapters 4.3 and 4.5 of Part 4 of the Technical Instructions.

(4) The operator of an aircraft shall preserve for not less than six months any dangerous goods transport document or other document in respect of dangerous goods which has been furnished to him in accordance with this regulation.

Shipper's responsibilities

4. Before consigning any package of dangerous goods for carriage by air the shipper shall ensure that:

- (a) the goods are not of a category whose carriage by air is prohibited by the provisions of Chapters 2.1 and 2.2 of Part 1 of the Technical Instructions;
- (b) the goods are classified and packed in accordance with Chapter 2.6 of Part 1 and Parts 2, 3 and 8 of the Technical Instructions and the packagings used are in accordance with such provisions of Part 7 of the Technical Instructions as apply to the goods;
- (c) the package is marked and labelled in accordance with such provisions of Chapter 11 of Part 2 and Part 3 as relate to marking and labelling and in accordance with Chapters 2 and 3 of Part 4 of the Technical Instructions;
- (d) the package is in a fit condition for carriage by air; and
- (e) the dangerous goods transport document required by regulation 5 has been completed and that the declaration therein has been signed by him or on his behalf.

Operator's responsibilities

5.—(1) The operator of an aircraft in or under which any package of dangerous goods or unit load device containing dangerous goods is to be carried shall ensure by means of an inspection that:

- (a) the package is marked and labelled in accordance with the provisions of these Regulations, such provisions of Chapter 11 of Part 2 and Part 3 as relate to marking and labelling and Chapters 2 and 3 of Part 4 of the Technical Instructions before accepting the package;
- (b) the package is not leaking or damaged so that the contents may escape:
 - (i) before accepting the package;
 - (ii) before loading or causing the package to be loaded on board the aircraft or before suspending or causing the package to be suspended beneath the aircraft, as the case may be;
 - (iii) upon unloading the package from or from beneath the aircraft;
- (c) the unit load device is free from any evidence of leakage from or damage to any dangerous goods contained therein before loading or causing the unit load device to be loaded on board the aircraft or before suspending or causing the unit load device to be suspended beneath the aircraft, as the case may be.

- (a) (2) (a) For the purpose of each of the inspections required by paragraphs (1)(a) and (1)(b)(i) an acceptance check list shall be used and the results of that inspection shall be recorded in accordance with the form thereof.
- (b) The acceptance check list shall be in such form and shall provide for the entry of such details as will enable the relevant inspection to be fully and accurately made by reference to and completion of that list.
- (c) The operator of an aircraft shall preserve for not less than six months a record of any acceptance check list completed in accordance with this regulation. The record may be in a legible or a non-legible form so long as the recording is capable of being reproduced in a legible form.

(3) The operator shall not load or cause to be loaded on an aircraft or suspend or cause to be suspended beneath an aircraft any package of dangerous goods or unit load device containing dangerous goods which on inspection is found to be leaking or damaged so that the contents or the dangerous goods therein may escape or be damaged.

(4) The operator shall unload or cause to be unloaded any package of dangerous goods which appears to be leaking or damaged on board or beneath an aircraft and shall ensure that other cargo or baggage loaded on or suspended beneath that aircraft is in a fit state for carriage by air and has not been contaminated.

(5) The operator shall after unloading inspect for signs of damage or contamination any part of the aircraft, or any sling or other apparatus which has been used to suspend goods beneath the aircraft, in which:

- (a) a unit load device containing dangerous goods was stowed, or
- (b) any damaged or leaking package of dangerous goods was loaded,

and the operator shall remove or repair any contamination or damage.

(6) The operator of an aircraft shall not permit it to fly for the purpose of carrying passengers or cargo if he knows or suspects radioactive materials to have leaked in or contaminated the aircraft or any sling or other apparatus attached to the aircraft unless the radiation level resulting from the fixed contamination at any accessible surface and the non-fixed contamination are not more than the values specified in Chapter 3.2 of Part 5 of the Technical Instructions.

Status: This is the original version (as it was originally made). This item of legislation is currently only available in its original format.

Method of loading by operator

6.—(1) The operator shall ensure that any package containing dangerous goods is loaded, stowed and unloaded from or from beneath an aircraft in accordance with the provisions in Chapter 2 of Part 5 of the Technical Instructions which apply to that category of dangerous goods.

(2) An aircraft shall not carry any dangerous goods either in any compartment occupied by passengers or in the flight crew compartment, except in circumstances permitted by the provisions of Chapter 2.1 of Part 5 of the Technical Instructions.

Provision of information and training programmes by operators and shippers

7.—(1) The operator of an aircraft in which dangerous goods are to be carried shall, before the flight begins, provide the commander of the aircraft with written information specifying the matters required by the provisions of Chapter 4.1 of Part 5 of the Technical Instructions and shall preserve a copy thereof for not less than six months.

(2) The operator of an aircraft in which passengers are to be carried or his agent shall notify those passengers of the categories of dangerous goods which may not be taken on board an aircraft either as checked baggage or accompanying a passenger by:

- (a) providing information with each passenger ticket sufficient in prominence for this purpose; and
- (b) displaying notices sufficient in number and prominence for this purpose:
 - (i) at each of the places at an airport where the operator or his agent issues tickets or maintains areas to assemble passengers to board the aircraft, and
 - (ii) at any location where baggage is checked in.

(3) The operator of an aircraft and a shipper of dangerous goods by air and, in each case, any agent thereof shall inform any of their respective employees whose duties include a function connected with the carriage of passengers or cargo by air of the provisions of the Technical Instructions and for this purpose shall establish and undertake training programmes, as required by Chapter 1 of Part 6 of the Technical Instructions, which shall be submitted to the Governor for approval on such occasions as the Governor may require and which shall be amended as the Governor may require.

Production of documents and records

8. The operator of an aircraft shall, within a reasonable time after being requested so to do by an authorised person, cause to be produced to that person such of the following documents as may have been requested by that person:

- (a) the written permission referred to in regulation 2(1);
- (b) the dangerous goods transport document or other document in respect of any dangerous goods, referred to in regulation 3;
- (c) the completed acceptance check list in a legible form in respect of any dangerous goods, referred to in regulation 5(2);
- (d) a copy of the written information provided to the commander of the aircraft in respect of any dangerous goods, referred to in regulation 7(1);
- (e) any document which relates to goods which the authorised person has reasonable grounds to suspect may be dangerous goods in respect of which the provisions of these Regulations have not been complied with.

Powers in relation to enforcement of the Regulations

9.—(1) An authorised person may examine, take samples of and seize any goods which the authorised person has reasonable grounds to suspect may be dangerous goods in respect of which the provisions of these Regulations have not been complied with.

(2) An authorised person may open or require to be opened any baggage or package which the authorised person has reasonable grounds to suspect may contain dangerous goods in respect of which the provisions of these Regulations have not been complied with.

- (a) (3) (a) Any sample taken or goods seized by an authorised person under this regulation shall be retained or detained respectively for so long as the Governor considers necessary in all the circumstances and shall be disposed of in such manner as the Governor considers appropriate in all the circumstances.
- (b) Without prejudice to the generality of sub-paragraph (a) any sample taken or goods seized under this regulation may be retained or detained respectively:
- (i) for use as evidence at a trial for an offence; or
 - (ii) for forensic examination or for investigation in connection with an offence.

Dropping articles for agricultural, horticultural, forestry or pollution control purposes

10. Subject to the provisions of regulation 2(1)(a) nothing in these Regulations shall apply to any aircraft flying in order to drop articles for the purpose of agriculture, horticulture, forestry or pollution control.

Police aircraft

11.—(1) Nothing in these Regulations shall apply to the carriage of dangerous goods for the purposes of providing medical aid to any person by an aircraft flying under and in accordance with the terms of a police air operator's certificate.

(2) Nothing in these Regulations other than regulation 2(1)(a) shall apply to the carriage of any other dangerous goods by an aircraft flying under and in accordance with the terms of a police air operator's certificate.

SCHEDULE 16

Article 103

AERODROME MANUAL

Information and instructions relating to the following matters shall be included in the aerodrome manual referred to in article 103 of this Order:

- (i) the name and status of the official in charge of day to day operation of the aerodrome together with the names and status of other senior aerodrome operating staff and instructions as to the order and circumstances in which they may be required to act as the official in charge,
- (ii) the system of aeronautical information service available;
- (iii) procedures for promulgating information concerning the aerodrome's state;
- (iv) procedures for the control of access, vehicles and work in relation to the aerodrome manoeuvring area and apron;
- (v) procedures for complying with article 117 of this Order and for the removal of disabled aircraft;
- (vi) in the case of an aerodrome which has facilities for fuel storage, procedures for complying with article 112 of this Order;

Status: This is the original version (as it was originally made). This item of legislation is currently only available in its original format.

- (vii) (aa) subject to sub-paragraph (bb), plans to a scale of 1:2500 depicting the layout of runways, taxiways and aprons, aerodrome markings, aerodrome lighting if such lighting is provided, and the siting of any navigational aids within the runway strip;
(bb) in the case of copies of the manual or extracts thereof provided or made available to a member of the aerodrome operating staff, the plans shall be of a scale reasonably appropriate for the purposes of article 103(10) of this Order;
- (viii) in respect of an aerodrome in relation to which there is a notified instrument approach procedure, survey information sufficient to provide data for the production of aeronautical charts relating to that aerodrome;
- (ix) description, height and location of obstacles which infringe standard obstacle limitation surfaces, and whether they are lit;
- (x) data for and method of calculation of declared distances and elevations at the beginning and end of each declared distance;
- (xi) method of calculating reduced declared distances and the procedure for their promulgation;
- (xii) details of surfaces and bearing strengths of runways, taxiways and aprons;
- (xiii) the system of the management of air traffic in the airspace associated with the aerodrome, including procedures for the co-ordination of traffic with adjacent aerodromes, except any such information or procedures already published in any manual of air traffic services;
- (xiv) operational procedures for the routine and special inspection of the aerodrome manoeuvring area and aprons;
- (xv) if operations are permitted during periods of low visibility, procedures for the protection of the runways during such periods;
- (xvi) procedures for the safe integration of all aviation activities undertaken at the aerodrome;
- (xvii) procedures for the control of bird hazards;
- (xviii) procedures for the use and inspection of the aerodrome lighting system, if such a system is provided; and
- (xix) the scale of rescue, first aid and fire service facilities, the aerodrome emergency procedures and procedures to be adopted in the event of temporary depletion of the rescue and fire service facilities.

SCHEDULE 17

Article 77

COSMIC RADIATION: KEEPING OF RECORDS

1.—(1) The record of the exposure to cosmic radiation of air crew assessed under article 75 of this Order and required to be kept under article 77(1) of this Order shall meet the requirements of this paragraph and in addition, as the case may be, the requirements of either sub-paragraph (1) or sub-paragraph (2) of paragraph 2.

(2) A record kept under article 77(1) of this Order shall contain details of the assessment of the exposure to cosmic radiation for a period of at least twelve months, but not details of exposure before the coming into force of this Order.

(3) A record kept under article 77(1) of this Order shall be available for production as a paper record for a period of two years from the date each assessment was made, except that where the assessment shows that an individual is liable to cosmic radiation exposure in excess of 6 milliSieverts per year the record shall be available as a paper record until whichever is the later of either—

- (a) the 75th anniversary of his birth, whether or not he has survived to that date, or
- (b) the 30th anniversary of the termination of his work which involved exposure to cosmic radiation.

2.—(1) When an undertaking separately assesses the exposure to cosmic radiation of the individual members of the air crew, the undertaking shall keep a record of the exposure to cosmic radiation for each member of the air crew assessed under article 75 of this Order, which record shall include:

- (a) the name of the member of crew;
- (b) the detail of each assessment of exposure expressed in milliSieverts per year; and
- (c) the date of the assessment.

(2) When an undertaking does not separately assess the exposure to cosmic radiation of the individual members of the air crew, but instead assesses the exposure to cosmic radiation of groups of air crew members the undertaking shall keep a single record for all the air crew assessed under article 75 of this Order, which record shall state:

- (a) the names of all air crew covered by the assessment;
- (b) the maximum dose of cosmic radiation expressed in milliSieverts per year to which those air crew are liable to be exposed;
- (c) how the dose in paragraph (b) is calculated; and
- (d) the period for which the assessment is valid.

SCHEDULE 18

Article 128

TERRITORIES TO WHICH THIS ORDER APPLIES

Anguilla
Bermuda
British Antarctic Territory
British Indian Ocean Territory
Cayman Islands
Falkland Islands
Montserrat
Pitcairn, Henderson, Ducie and Oeno Islands
St. Helena
St. Helena Dependencies (Tristan da Cunha and Ascension Island)
South Georgia and the South Sandwich Islands
Sovereign Base Areas of Akrotiri and Dhekelia
Turks and Caicos Islands
Virgin Islands

TABLE OF COMPARISON

The following Table shows, in relation to each article of the Air Navigation (Overseas Territories) Order 1989, as amended, the article of the 2001 Order in which it is reproduced.

Status: This is the original version (as it was originally made). This item of legislation is currently only available in its original format.

<i>1989 Order as amended</i>	<i>2001 Order</i>
1	1
2	2
3	3
4	4
5	5
6	6
—	7
7	8
8	9
9	10
10	11
11	12
12	13
13	14
14	15
—	16
15	17
16	18
17	19
18	20
19	21
20	22 23 24 25 26
21	27
22	28
23	29
24	30
25	31
—	32
26	33
27	34
28	35
29	36
—	37
30	38

Status: This is the original version (as it was originally made). This item of legislation is currently only available in its original format.

<i>1989 Order as amended</i>	<i>2001 Order</i>
31	39
31A	40
32	41
33	42
33A	43
34	44 45
35	46
36	47 48 49
36A	50
36B	51
—	52
37	53
38	54
39	55
40	56
41	57
42	58
43	59
44	60
45	61
46	62
47	63
48	64
49	65
50	66
51	67
—	68
52	69
—	70
53	71
54	72
55	73
56	74
—	75

Status: This is the original version (as it was originally made). This item of legislation is currently only available in its original format.

<i>1989 Order as amended</i>	<i>2001 Order</i>
57	76
58	77
59	78
60	79
61	80
62	81
62A	82
63	83
64	84
64A	88 90
64B	91
65	92 98
66	94 99
66A	97
67	100
68	95
68A	96
69	85
70	86
—	87
—	89
—	93
71	101
72	102
73	103
74	104
75	105
76	106
77	107
78	108
79	109
80	110
81	111
82	112

Status: This is the original version (as it was originally made). This item of legislation is currently only available in its original format.

<i>1989 Order as amended</i>	<i>2001 Order</i>
83	113
94	125
83A	—
—	114
84	115
85	116
86	117
87	118
88	119
89	120
90	121
91	122
92	123
93	124
95	126
96	127
97	128
98	129
99	130
99A	131
100	132
101	133
102	134
—	135
—	

EXPLANATORY NOTE

(This note is not part of the Order)

This Order, except as regards Gibraltar, supersedes the Air Navigation (Overseas Territories) Order 1989 (S.I. [1989/2395](#)), as amended (S.I. [1991/189](#), S.I. [1991/1697](#), S.I. [1992/3198](#), S.I. [1995/2701](#) and S.I. [1997/1746](#)).

Status: This is the original version (as it was originally made). This item of legislation is currently only available in its original format.

The Order is based closely on the Air Navigation Order 2000 (S.I. [2000/1562](#)).

The main differences between this Order and the Air Navigation Order are, first, that some of the provisions of the Air Navigation Order which reflect obligations of the United Kingdom as a member of the European Union and as a member of the Joint Aviation Authorities (JAA) are not reproduced in this Order. Secondly, this Order contains the Rules of the Air (Schedule 13), the Air Navigation (General) Regulations (Schedule 14), the Air Navigation (Dangerous Goods) Regulations (Schedule 15) and the Air Navigation (Cosmic Radiation) (Keeping of Records) Regulations (Schedule 17) instead of these being prescribed by the Secretary of State as in the United Kingdom.

The Table of Comparison specifies the corresponding article numbers of the Air Navigation (Overseas Territories) Order 1989, as amended.

In addition to some minor drafting amendments, the following changes are made:

(1) Mortgagees under aircraft mortgages registered pursuant to local legislation are protected from aircraft being removed from the aircraft register of the Territory (article 4(17)).

(2) A requirement has been introduced for aircraft in the service of the police to be operated in accordance with a police air operator's certificate and special provision is made for aircraft flying in accordance with a police air operator's certificate (articles 7, 20(3)(b)(iii) and (c)(iii), 31, 32, 33, 36(5)(c) and (d) (6)(b) and (8), 38(2), 42(2), 44(2), 45(1), 57(1) and (4) 59, 61(3), 101, Schedule 4 paragraph 10 of the Table and paragraph 5 Scale EE, Schedule 13 rules 5 and 17, Schedule 14 regulations 12 and 13 and Schedule 15 regulation 11).

(3) Responsibilities in respect of airworthiness, radio equipment, radio licensing and flight crew licensing in connection with an aircraft may be discharged by the State of the operator rather than its State of registration in certain circumstances pursuant to Article 83 bis of the Chicago Convention (articles 8(1), 15(1), 21(3), 46(1) and 130(1)).

(4) An aircraft registered in the Territory which has a certificate of airworthiness in the private category must be maintained in accordance with an approved maintenance schedule (article 10(1)).

(5) A technical log must be preserved for 2 years after the aircraft to which it relates has been destroyed or withdrawn from use (article 11(5)).

(6) It is an offence for the holder of an aircraft maintenance engineer's licence to exercise the privileges of that licence when physically or mentally unfit or under the influence of drink or a drug (article 13(7) and (8)).

(7) Minimum equipment requirements enable the Governor to give permission for an aircraft to fly notwithstanding that specified equipment is not carried or is unserviceable (articles 16 and 43(b) (ii) and Schedules 10 and 11).

(8) A helicopter which is registered in the Territory and which has a maximum total weight authorised of 5,700 kg or less and a maximum approved seating configuration of 9 or less when flying according to Instrument Flight Rules or at night must either carry 2 pilots or be equipped with an autopilot. A helicopter flying for the purpose of public transport at night with visual ground reference must be appropriately equipped depending on whether it is flying with one or two pilots. Every pilot included in the flight crew of a helicopter flying for the purpose of public transport whose licence does not include an instrument rating but who is intended to fly at night under visual flight conditions must be tested by the operator as to his competence (article 20 and Schedules 4 and 10).

(9) When flying over an area specified in the Order without a flight navigator, suitable navigational equipment must be carried but this equipment is no longer required to be approved by the Governor (article 20(4)).

(10) Provision for three categories of licence (Flight Radio Telephony Operator's General Licence, Flight Radio Telegraphy Operator's Licence and Flight Radio Telegraphy Operator's Temporary Licence) are removed from the Order and the remaining licence is renamed Flight

Radiotelephony Operator's Licence. The minimum age for holding a Flight Radiotelephony Operator's Licence is 16 years. A flight radiotelephony operator may now perform other duties on the flight (article 20(5), 130(1) and Schedule 8).

(11) The minimum age for flying solo is 16 years (article 21(2)(b)).

(12) The circumstances in which a person may act as a member of the flight crew of an aircraft without holding an appropriate licence for the purpose of qualifying for a licence or rating are extended, though flights can no longer be undertaken under article 21(5) on the basis of a validated foreign licence (article 21(2)(c), (d) and (e) and (5)).

(13) A glider pilot communicating by radio with an air traffic control unit must hold an appropriate flight radiotelephony operator's licence (article 21(2) and (9)).

(14) A licence granted under the law of a Contracting State other than the Territory is no longer deemed to be rendered valid for purposes of entitling the holder to fly in any controlled airspace in circumstances requiring compliance with the Instrument Flight Rules (article 21(4)(b)).

(15) The distinction between medical examinations conducted inside and outside the Territory has been removed (article 25(1)).

(16) The operator of an aircraft flying for the purpose of public transport must satisfy himself as to the suitability of any site at which it is intended to take off or land. He need not generally satisfy himself about the adequacy of emergency services which are not required to be based at the site but such a requirement may be imposed by way of a condition of the air operator's certificate (article 34(1)(c) and (2)).

(17) An aeroplane which is not registered in the Territory and is powered by one engine only may not fly for the purpose of public transport at night or when weather conditions are below specified minima (article 37).

(18) The operator of a public transport aircraft which is not registered in the Territory is no longer required to furnish to the Governor particulars of aerodrome operating minima. The operator of any such aircraft requires approval from the Governor to conduct aircraft operations to Category II and III minima (article 39).

(19) The requirement for passenger briefing by the commander of an aircraft now applies to all aircraft registered in the Territory other than those flying in accordance with a police air operator's certificate (article 44).

(20) The requirement to maintain a telecommunications log is omitted (article 46 and Schedule 11).

(21) An aircraft may not fly within airspace notified as reduced vertical separation minimum airspace unless it is equipped with appropriate height keeping equipment which, in the case of an aircraft registered in the Territory, must be installed, maintained and operated in a manner approved by the Governor (articles 48, 49 and 130).

(22) From January 2003, an airborne collision avoidance system which meets specified requirements must be carried by a turbine engined aircraft with a maximum take off weight authorised exceeding 15,000 kg or authorised to carry more than 30 passengers if registered in or flying within the Territory (article 52, Schedule 5 and Schedule 10).

(23) A definition of sporting weapon is now provided (article 59).

(24) The requirement to obey all lawful commands of the commander is extended to persons in an aircraft not registered in the Territory while the aircraft is in the Territory (article 67).

(25) It is an offence to act in a disruptive manner while in an aircraft, including using threatening language towards a member of the crew of the aircraft or behaving in a disorderly manner towards a member of the crew of the aircraft (article 58).

Status: This is the original version (as it was originally made). This item of legislation is currently only available in its original format.

(26) Flying displays now require the permission of the Governor (article 70 and Schedule 13 rule 5).

(27) An undertaking in the Territory which operates aircraft must assess the exposure to cosmic radiation of the air crew who are liable to be subject to cosmic radiation in excess of 1 milliSievert per year, to take account of the assessed exposure when organising work schedules, to inform workers of the health risks, to make additional provision for air crew who are pregnant or breast feeding, to keep a record of assessed exposure to cosmic radiation and to provide the record on request to the Governor and the air crew concerned (articles 75 and 77 and Schedule 17).

(28) The operator of an aircraft with a certificate of airworthiness in the transport or aerial work category must produce the technical log and certificate of maintenance review of that aircraft if required to do so by an authorised person (article 78(2)).

(29) The Governor, as well as the Secretary of State, now has power to revoke, suspend or vary permissions granted under article 115 with respect to aerial photography, aerial survey or aerial work in aircraft registered elsewhere than in the Territory (article 81).

(30) The restrictions applicable to flights by balloons, kites, airships, gliders and parascending parachutes have been revised. New definitions are introduced for controllable and uncontrollable balloons and for free controlled flight, tethered flight, captive flight and released flight. Restrictions are placed on the simultaneous release of large numbers of small balloons from a single site (articles 86 and 130).

(31) A person flying a small aircraft (for which a definition has been introduced) which weighs more than 7 kg must do so in accordance with specified conditions (articles 87, 130 and 132).

(32) A person must not provide an air traffic control service otherwise than in accordance with a manual of air traffic services which must be produced to the Governor on request and amended if so required by him (article 89).

(33) The provisions concerning the licensing of persons providing air traffic services entitle the Governor to require applicants for licences to undertake courses of training and to approve such courses. An air traffic controller's licence may now be granted to a person who has attained the age of 20 years. A certificate of competence is required to be included in an air traffic controller's licence and renewed annually. A new rating is introduced for the exercise of licence privileges at an area control centre (formerly called an air traffic control centre). A new rating is introduced for the task of providing radar services to en route aircraft more than 40 miles from an aerodrome. Only specifically approved licence holders are entitled to supervise student air traffic controllers or air traffic controllers who do not hold an appropriate rating. Definitions are introduced for an aerodrome control service, an approach control service, an area control service and an area control centre. "Sector" has been redefined. An area control rating and an area radar rating are introduced. The area radar control (aerodrome) rating and the precision approach control rating are deleted. To provide radar services to en route aircraft more than 40 miles from the aerodrome at which the controller is based a controller will require an area radar rating. The functions of the area radar control and the approach radar control rating may be exercised at the same time (Part IX, article 130 and Schedule 9).

(34) An amendment is made to make it clear that an air traffic controller's licence is not required by members of HM Forces or a visiting force (article 94(5)).

(35) If a flight information service officer does not provide a service at a particular aerodrome or area control centre throughout a period of 90 days, his licence shall cease to be valid at that aerodrome or area control centre (article 98(3)).

(36) The Governor can no longer require an aerodrome to have a licence for public use (article 103(3)).

(37) Provision has been made for the Secretary of State to delegate to the Governor the power to approve and disapprove tariffs for services operated to or from the Territory by aircraft not registered in the Territories or in the United Kingdom (article 114).

(38) The requirement for mandatory reporting of occurrences applies to the operator or commander of any public transport aircraft registered in the Territory, any public transport aircraft wherever registered operated by the holder of an air operator's certificate granted by the Governor and any aircraft registered in the Territory which is powered by one or more turbine engines; a serious incident reported under accident investigation regulations in force in the Territory does not constitute a reportable occurrence for purposes of article 117 (article 117).

(39) The charterer of an aircraft is added to the list of persons referred to in article 122 (Penalties) insofar as that article concerns article 113 of the Order (Restrictions with respect to carriage for valuable consideration in aircraft registered outside the Territory); the penalties on summary conviction have been increased to a maximum of £5000 for an offence in Part B of Schedule 12, £2,500 for an offence in Part A of that Schedule and £1,000 for any other offence (article 122).

(40) The Governor can no longer grant exemptions from the provisions of article 116 of the Order relating to flights over a foreign country (article 126).

(41) An air transport undertaking is now defined as an undertaking whose business includes flying for purposes of public transport (article 130(1)).

(42) A flight information service includes the granting or refusing of permission to an aircraft to taxi on the apron or the manoeuvring area of an aerodrome or to a vehicle or person to go on the manoeuvring area of an aerodrome (article 130(1)).

(43) Crew is now defined as being the flight crew, cabin attendants and persons carried on the flight deck to supervise training, experience, practice and periodical tests required of the flight crew (article 130(1));

(44) The definition of "Governor" has been amended to include (for purposes other than making rules and regulations under the Order and designating customs and excise aerodromes) any person appointed by the Governor as Director of Civil Aviation responsible under the law of the Territory on behalf of the Governor for the administration of the Order (article 130(1));

(45) Valuable consideration passing wholly within a group of companies is disregarded for the purpose of considering whether a flight is for the purpose of public transport (article 131(5)).

(46) The Governor must now publish the requirements which must be met by the applicant for a licence, certificate or other document if the applicant is to satisfy the Governor that he meets the criteria for the grant of the licence certificate or other document (article 135);

(47) Powered lift (tilt rotor) aircraft are now included in the table of general classification of aircraft (Schedule 2 Part A);

(48) The purposes for which aircraft may fly in accordance with A and B Conditions are extended and clarified (Schedule 3 Part A);

(49) Aeroplanes registered in the Territory that are powered by one or more turbine jets or by one or more turbine propeller engines must be equipped with a terrain awareness and warning system:

by the date of coming into force of the Order if first issued with a certificate of airworthiness on or after 1st July 2001, operating for the purpose of public transport, and weighing more than 15,000 kg or certificated to carry more than 30 passengers;

by 1st October 2001 if weighing more than 5,700 kg or certificated to carry more than 9 passengers, whether or not flying for the purpose of public transport if not equipped with a ground proximity warning system before 1st April 2000;

by 1st January 2005 if weighing more than 5,700 kg or certificated to carry more than 9 passengers, whether or not operating for the purpose of public transport if equipped with a ground proximity warning system before 1st April 2000 (Schedule 4).

Status: This is the original version (as it was originally made). This item of legislation is currently only available in its original format.

(50) Controlled airspace is no longer sub-divided for the purposes of Schedules 4 and 5 (carriage of aircraft equipment and radio navigation equipment). Equipment requirements now apply equally in respect of all controlled airspace. A non-public transport aircraft flying in Class D or Class E airspace is not required to carry distance measuring equipment (Schedules 4 and 5).

(51) A glider must carry radiocommunications equipment when flying above Flight Level 245 or in controlled airspace below Flight Level 245 notified for the purpose (Schedule 5, Table at paragraph 2).

(52) The holder of a Private Pilot's Licence or Basic Commercial Pilot's Licence who has neither an instrument rating nor an Instrument Meteorological Conditions rating may not fly on a flight outside controlled airspace when the flight visibility is less than 3 km (Schedule 8 Part A Privileges of Private Pilot's Licence and Basic Commercial Pilot's Licence).

(53) Changes are made to the privileges of Territory aeroplane and helicopter pilot's licences. Recent experience of night take offs and landings is required only for flights in which passengers are carried. A recency requirement is introduced for flights by day on which passengers may be carried. The 20,000 kg limit for holders of Commercial Pilot's Licence (Aeroplanes) and (Helicopters and Gyroplanes) and Airline Transport Pilot's Licence (Aeroplanes) and (Helicopters and Gyroplanes) over age 60 is removed. Co-pilots of helicopters flying on scheduled journeys or for public transport in instrument meteorological conditions must hold an instrument rating (Schedule 8).

(54) A separate private pilot's licence is introduced for helicopters and for gyroplanes rather than a single combined licence (Schedule 8).

(55) An operator's Operations Manual must now include a statement of the operator's accident prevention and flight safety programme and safety policy, together with a list of the post holders responsible for ensuring that the operator's safety policy is fulfilled, showing the duties of each post holder in relation to that policy (Schedule 10, Part A).

(56) Schedule 13, which sets out the Rules of the Air has been amended: rule 1 now includes a definition of "Special VFR Flight"; rule 23 imposes speed restrictions on aircraft flying below Flight Level 100; rule 24(3) provides that when taking off or approaching to land at an aerodrome within Class B, C or D airspace, any visibility communicated to the commander of the aeroplane by the appropriate air traffic control unit shall be taken to be the flight visibility; rule 27 requires a VFR flight plan to be filed and an air traffic clearance to be obtained; rules 35 and 36 provide that permission required by an aircraft to taxi on the apron or the manoeuvring area of an aerodrome or by a vehicle or person to go or move on the manoeuvring area of an aerodrome may be obtained from the aerodrome flight information service unit; rules 27(3) and 31(3) require flight plans for flight within Territory RVSM airspace to state whether the aircraft is equipped with height keeping performance systems required by article 48 and 49; provision is no longer made for warning signals to be made to aircraft in flight by projectiles discharged from the ground (Schedule 13).

(57) Schedule 14, which sets out the Air Navigation (General) Regulations, has been amended: Regulation 2 introduces new notional passenger and crew weights for aeroplanes and helicopters of all sizes; for aircraft with 30 or more passenger seats, there is an option to use "all adult" notional weights; the notional weights differ from holiday charter to non-holiday charter flights; hand baggage is included with the new notional weights; new notional hold baggage weights are introduced; notional hold baggage weights are only available for aircraft with 20 or more passenger seats; the coordinates defining Europe have been amended; regulation 20 prescribes requirements which must be met by an airborne collision avoidance system carried in accordance with the Order (Schedule 14).

(58) Schedule 15, which sets out the Air Navigation (Dangerous Goods) Regulations has been amended; in regulation 1, "dangerous goods" is defined by reference only to the definition in the Technical Instructions and the definition of "Technical Instructions" now refers to the 1999–2000 English language edition of the Technical Instructions for the Safe Transport of Dangerous Goods by Air approved and published by decision of the Council of the International Civil Aviation Organisation (Schedule 15).

Document Generated: 2024-03-19

Status: *This is the original version (as it was originally made). This item of legislation is currently only available in its original format.*

Copies of the 1999–2000 English language edition of the Technical Instructions for the Safe Transport of Dangerous Goods by Air can be purchased from Freight Merchandising Services, Unit 19, Ashford Industrial Estate, Shield Road, Ashford, Middlesex, TW15 1AU, England.